

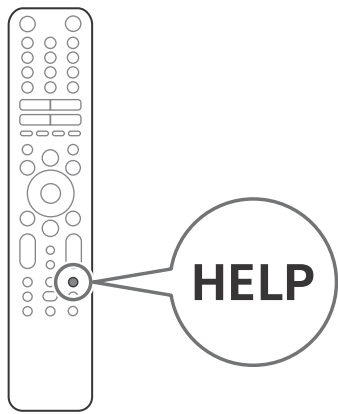

Television

Reference Guide



BRAVIA

XR-85Z9J / 75Z9J

About Manuals

This TV comes with the following manuals. Please retain the manuals for future reference.

<p>Setup Guide</p> <ul style="list-style-type: none"> TV installation and setup. 	
<p>Reference Guide (this manual) / Safety Documentation</p> <ul style="list-style-type: none"> Safety information, remote control, troubleshooting, wall-mount installation, specification, etc. 	
<p>Help Guide (On screen Manual)</p> <ul style="list-style-type: none"> Settings, functions, Internet connection, troubleshooting, etc. To open it, press the HELP button on the remote control and select Help Guide. 	<p>You can refer to the Help Guide with your smartphone.</p> <p>https://rd1.sony.net/help/tv/iga1/h_ga/</p>

Setting menus are subject to change without notice.

IMPORTANT – Read the End User Software Licence Agreement before using your Sony product. Using your product indicates your acceptance of the End User Software Licence Agreement. The software licence agreement between you and Sony is available online at Sony website (<https://www.sony.net/tv-software-licenses/>) or on your product screen. Press **⚙** (Quick Settings) on the remote control and select [Settings] → [System] → [About] → [Legal information] → [Notices and licences].

Note

- Before operating the TV, please read the "Safety Information".
- Read the supplied safety documentation for additional safety information.
- Instructions about "Installing the TV to the Wall" are included within this TV's instruction manual.
- Images and illustrations used in the Setup Guide and this manual are for reference only and may differ from the actual product.

Location of the identification label

Labels for the TV Model No. and Power Supply rating are located on the rear of the TV. They can be found by removing the terminal cover.

Safety Information

Installation/Set-up

Install and use the TV set in accordance with the instructions below in order to avoid any risk of fire, electric shock or damage and/or injuries.

- Installation**
- The TV set should be installed near an easily accessible AC power outlet (mains socket).
 - Place the TV set on a stable, level surface to prevent it from falling over and causing personal injury or property damage.
 - Install the TV where it cannot be pulled, pushed, or knocked over.

- Install the TV so that the TV's Table-Top Stand does not protrude out from the TV stand (not supplied). If the Table-Top Stand protrudes out from the TV stand, it may cause TV set to topple over, fall down, and cause personal injury or damage to the TV.

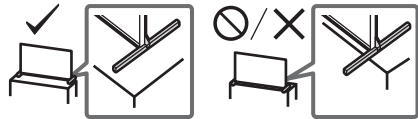

Transporting

- Before transporting the TV set, disconnect all cables.
- Before transporting the TV set, remove the terminal covers.
- Two or more people (three or more people for XR-85Z9J) are needed to transport a large TV set.
- When transporting the TV set by hand, hold it as shown below. Do not put stress on the LCD panel and the frame around the screen.

XR-85Z9J

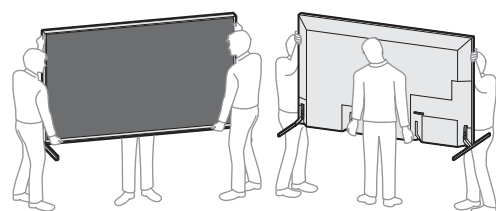

- When transporting the TV set, do not subject it to jolts or excessive vibration.
- When transporting the TV set for repairs or when moving, pack it using the original carton and packing material.

Topple prevention (Models with supplied support belt kit)

Refer to the Setup Guide on top of the cushion. The supplied wood screw is only for affixing to a solid object made of wood.

(Except models with supplied support belt kit)

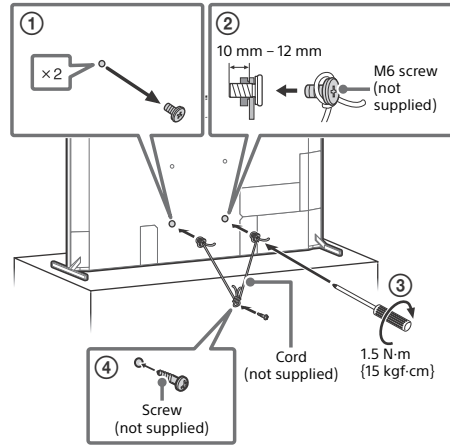

Using TV as Centre Speaker

Note

- Before connecting cables, disconnect the AC power cord (mains lead) of both TV and AV receiver.

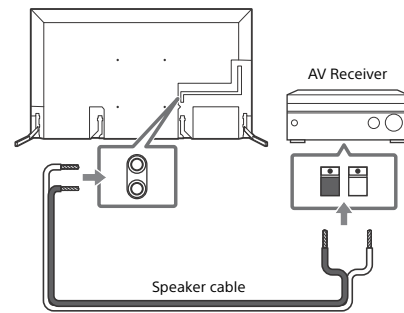

Using TV as Part of Audio System

Note

- Before connecting cables, disconnect the AC power cord (mains lead) of both TV and AV receiver.
- Refer to the instruction manual of the Audio system with S-CENTER OUT terminal for detail.

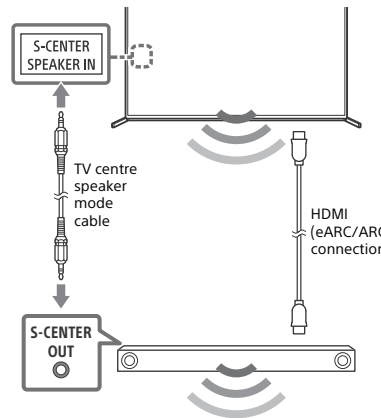

Remote Control and TV

The remote control shape, layout, availability and function of remote control buttons may vary depending on your region/country/TV model/TV settings.

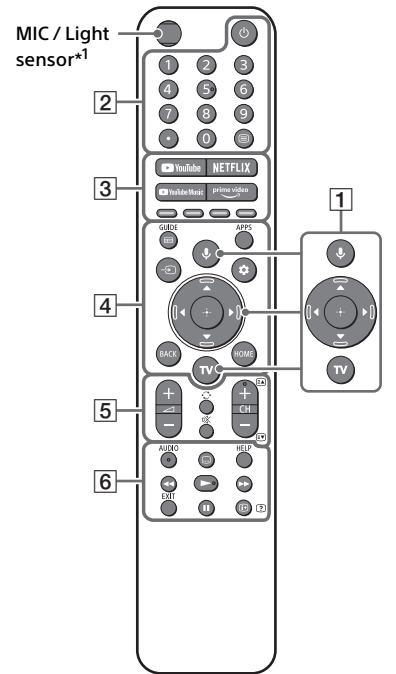

1 **⏻ (Microphone) / Ⓜ (Google Assistant):** Use Google Assistant*2*3 or voice search*3. For hints on how to control your TV, press the microphone button on the remote control and say "voice hints".*2

▲/▼/◀/▶/⊕: On screen menu navigation and selection.

TV: Display TV channel list or switch to input.

2 **⏻ (Power)**

Number buttons

⬤ (dot)

☰ (Text): Display text information.

3 **YouTube™ / NETFLIX*4 / YouTube Music / Prime Video / Colour buttons**

4 **GUIDE/☰:** Display the digital programme guide of TV or TV box*5.

APPS

⏻ (Input select): Display and select the input source, etc.

⚙ (Quick settings): Display Quick Settings.

BACK

HOME

5 **↔ +/- (Volume)**

⏮ (Jump)

⏸ (Mute)*6

CH +/-/⏪/⏩: Select the channel, or next (⏪) / previous (⏩) page.

6 **AUDIO:** Select the sound of multilingual source or dual sound (depend on programme source).

☰ (Subtitle setting)

HELP: Display the Help menu.

◀/▶/⏮/⏭/⏩/⏸

EXIT

Ⓜ/? (Info/Text reveal): Display information.

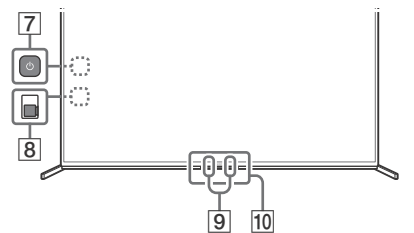

7 **⏻ (Power):** (It can be found by removing the side cover)

8 **BUILT-IN MIC SWITCH:** Turn on/off the built-in MIC. (It can be found by removing the side cover)

9 **Built-in MIC*2*3*7:** To enable the built-in MIC, press the microphone button on the remote control and follow the on-screen instructions.

10 **Remote Control sensor / Ambient light sensor / LED**

*1 The remote control backlight will illuminate when the light sensor detects the ambient light is low. Automatic illumination of the backlight can be turned off.

*2 Only on limited region/country/TV model/language.

*3 Google Assistant or voice search requires an Internet connection.

*4 Installation might be required depending on region/country.

*5 [TV box setup] setting is required.

*6 Accessibility shortcut is available by pressing and holding ⏸ (Mute).

*7 Power consumption will increase when the built-in MIC is enabled as it is always listening.

HELP For more information, refer to the Help Guide.

Installing the TV to the Wall

Using the optional Wall-Mount Bracket (SU-WL450)* (not supplied)

To Customers:

For product protection and safety reasons, Sony strongly recommends that installation of your TV be performed by Sony dealers or licensed contractors. Do not attempt to install it yourself.

To Sony Dealers and Contractors:

Provide full attention to safety during the installation, periodic maintenance and examination of this product.

Wall-Mount Bracket Installation Information

For instructions on Wall-Mount Bracket installation, see the Installation Information (Wall-Mount Bracket) on the product page for your TV model.

<https://www.sony-asia.com/support>

- Follow the instruction guide provided with the Wall-Mount Bracket for your model. Sufficient expertise is required in installing this TV, especially to determine the strength of the wall for withstanding the TV's weight.
- Sony is not liable for any damage or injury caused by mishandling or improper installation.
- Only qualified service personnel should carry out wall-mount installations.
- For safety reasons, it is strongly recommended that you use Sony accessories, including:
 - Wall-Mount Bracket SU-WL450
- Be sure to use the screws supplied with the Wall-Mount Bracket when attaching the Wall-Mount Bracket to the TV set. The supplied screws are designed as indicated by illustration when measured from the attaching surface of the Wall-Mount Bracket. The diameter and length of the screws differ depending on the Wall-Mount Bracket model. Use of screws other than those supplied may result in internal damage to the TV set or cause it to fall, etc.

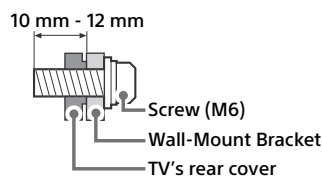

- Be sure to store the unused screws and Table-Top Stand in a safe place until you are ready to attach the Table-Top Stand. Keep the screws away from small children.

* Only on limited region/country/TV model.

Troubleshooting

General troubleshooting for issues like: black screen, no sound, frozen picture, TV does not respond, or network is lost, do the following steps.

- Restart your TV by pressing the power button on the remote control for about five seconds. The TV will restart. If the TV does not recover, try unplugging the AC power cord (mains lead) then press the power button on the TV and release it. Wait for two minutes, and plug in the AC power cord (mains lead).
Or, press the power button on the TV for about 40 seconds until the TV turns off.
- Refer to the Help menu by pressing **HELP** on the remote control.
- Connect your TV to the Internet and perform a software update. Sony recommends you to keep your TV software updated. Software updates provide new features and performance improvements.
- Visit Sony support website (information provided at the end of this manual).

When you plug in the TV, the TV may not be able to turn on for a while even if you press the power button on the remote control or the TV.

It takes time to initialize the system. Wait for about one minute, then operate it again.

The remote control does not function.

- Replace the batteries.

The parental lock password has been forgotten.

- Enter 9999 for the PIN and enter the new PIN.

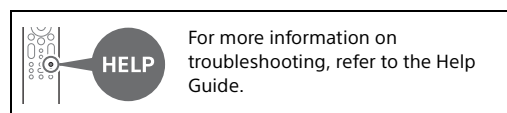

Specifications

System

Panel system: LCD (Liquid Crystal Display) Panel, LED Backlight

TV system: Depend on your country/area selection/TV model

Analogue: B/G, I, D/K, M

Digital: DVB-T/DVB-T2

Colour system: PAL/SECAM/NTSC3.58/NTSC4.43

Channel coverage: Depend on your country/area selection/TV model

Analogue: UHF/VHF/Cable

Digital: UHF/VHF

Sound output: 12.5 W + 12.5 W + 20 W + 20 W + 5 W + 5 W + 5 W + 5 W

Wireless technology

Protocol IEEE 802.11a/b/g/n/ac

Bluetooth® Version 4.2

Input/Output jacks

Antenna (aerial)/cable

75 ohm external terminal for VHF/UHF

VIDEO IN / S-CENTER SPEAKER IN

Video/Audio input (mini jack)

S-centre speaker input (mini jack)

HDMI IN 1/2/3/4 (HDCP 2.3-compatible)

Video:

4096 × 2160p (50, 60 Hz)^{*1*2}, 4096 × 2160p (24 Hz)^{*1}, 3840 × 2160p (50, 60 Hz)^{*2}, 3840 × 2160p (24, 25, 30 Hz), 1080p (30, 50, 60, 100, 120 Hz), 1080/24p, 1080i (50, 60 Hz), 720p (30, 50, 60 Hz), 720/24p, 576p, 480p, PC Formats^{*3}
7680 × 4320p (24, 25, 30, 50, 60 Hz)^{*2*4*5}, 3840 × 2160p (100, 120 Hz)^{*2*4*6}

Audio:

In eARC (Enhanced Audio Return Channel) mode
Refer to the online Help Guide for details.

Except eARC mode

5.1 channel linear PCM: 32/44.1/48/88.2/96/176.4/192 kHz 16/20/24 bits, Dolby Audio, Dolby Atmos, DTS

eARC/ARC (Enhanced Audio Return Channel/Audio Return Channel) (HDMI IN 3 only)^{*7}

In eARC mode

Refer to the online Help Guide for details.

In ARC mode

Two channel linear PCM: 48 kHz 16 bits, Dolby Audio, Dolby Atmos, DTS

DIGITAL AUDIO OUT (OPTICAL)

Digital optical jack (Two channel linear PCM: 48 kHz 16 bits, Dolby Audio, DTS)

(Stereo mini jack)

Headphone

1, 2, 3

USB port 1 and 2 support High Speed USB (USB 2.0)

USB port 3 supports Super Speed USB (USB 3.1 Gen 1)

LAN

10BASE-T/100BASE-TX connector (Depending on the operating environment of the network, connection speed may differ. The communication rate and quality are not guaranteed.)

CENTER SPEAKER IN

Centre speaker input (Binding post)

Power and others

Power requirements

110 V - 240 V AC, 50/60 Hz (except India model)

220 V - 240 V AC, 50/60 Hz (India model only)

Screen size (measured diagonally) (Approx.)

XR-85Z9J: 85 inches / 214.8 cm

XR-75Z9J: 75 inches / 189.3 cm

Power consumption

Indicated on the rear of the TV

Standby power consumption^{*8*9}

Jordan/UAE/Egypt: 0.50 W, Others: 0.5 W

Display resolution (horizontal × vertical) (pixels)

7680 × 4320

Output rating

500 mA (for USB 1/2), 900 mA (for USB 3)

Dimensions (Approx.) (w × h × d) (mm)

with Table-Top Stand

Standard position:

XR-85Z9J: 1937 × 1123 × 484

XR-75Z9J: 1711 × 993 × 428

Narrow position:

XR-85Z9J: 1907 × 1142 × 484

XR-75Z9J: 1681 × 1012 × 428

Soundbar position:

XR-85Z9J: 1937 × 1197 × 484

XR-75Z9J: 1711 × 1067 × 428

without Table-Top Stand

XR-85Z9J: 1907 × 1112 × 81

XR-75Z9J: 1681 × 982 × 81

Stand width (Approx.) (mm)

Standard position:

XR-85Z9J: 1937

XR-75Z9J: 1711

Narrow position:

XR-85Z9J: 854

XR-75Z9J: 627

Soundbar position:

XR-85Z9J: 1937

XR-75Z9J: 1711

Mass (Approx.) (kg)

with Table-Top Stand

XR-85Z9J: 63.4

XR-75Z9J: 48

without Table-Top Stand

XR-85Z9J: 61.7

XR-75Z9J: 46.4

Others

Optional accessories

Wall-Mount Bracket: SU-WL450

Operating temperature: 0 °C – 40 °C

*1 When 4096 × 2160p is input and [Wide mode] is set to [Normal], the resolution is displayed as 3840 × 2160p. To display 4096 × 2160p, set [Wide mode] setting to [Full 1] or [Full 2].

*2 Refer to the on screen menu to set [HDMI signal format].

*3 Refer to the online Help Guide for details.

*4 Use the Ultra High Speed HDMI Cable to connect.

*5 HDMI IN 4 only. Connect 8K supported HDMI devices to HDMI IN 4. HDMI IN 4 has complex signal processing and takes additional time to get video (depend on source).

*6 HDMI IN 2/3/4 only.

*7 Connect your audio system to the HDMI IN 3 to route TV audio to your audio system.

*8 Specified standby power is reached after the TV finishes necessary internal processes.

*9 Standby power consumption will increase when your TV is connected to the network.

Note

- Optional accessories availability depends on countries/region/TV model/stock.
- Design and specifications are subject to change without notice.
- Subscriptions for services and applications may be required and additional terms, conditions and/or charges may apply when using Google Assistant.

Notes on Digital TV function

- Any functions related to Digital TV (DVB) will only work in countries or areas where DVB-T/DVB-T2 (MPEG-2 and H.264/MPEG-4 AVC) digital terrestrial signals are broadcast. Please confirm with your local dealer if you can receive a DVB-T/DVB-T2 signal where you live.
- This TV set complies with DVB-T/DVB-T2 specifications, but compatibility with future DVB-T/DVB-T2 digital terrestrial broadcasts are not guaranteed.
- Some Digital TV functions may not be available in some countries/areas.

Trademark Information

- The terms HDMI, HDMI High-Definition Multimedia Interface, and the HDMI Logo are trademarks or registered trademarks of HDMI Licensing Administrator, Inc.
- Dolby, Dolby Vision, Dolby Atmos, Dolby Audio, and the double-D symbol are trademarks of Dolby Laboratories Licensing Corporation. Manufactured under license from Dolby Laboratories. Confidential unpublished works. Copyright © 1992-2020 Dolby Laboratories. All rights reserved.
- Gracenote, the Gracenote logo and logotype, "Powered by Gracenote" logo are either registered trademarks or trademarks of Gracenote, Inc. in the United States and/or other countries.
- Google TV and related logos are trademarks of Google LLC.
- For DTS patents, see <http://patents.dts.com>. Manufactured under license from DTS, Inc. DTS, Digital Surround, and the DTS logo are registered trademarks or trademarks of DTS, Inc. in the United States and other countries. © 2020 DTS, Inc. ALL RIGHTS RESERVED.
- Netflix is a registered trademark of Netflix, Inc.
- TUXERA is a registered trademark of Tuxera Inc. in the US and other countries.
- All other trademarks are the property of their respective owners.

