

SONY[®]

Home Theatre System

Operating Instructions

IMPORTANT – Read the End User Software License Agreement before using your Sony product. Using your product indicates your acceptance of the End User Software License Agreement. The software license agreement between you and Sony is available at the following URL:
<https://rd1.sony.net/help/ht/eula2/en2/>

WARNING

Do not install the speaker system in a confined space, such as a bookcase or built-in cabinet.

To reduce the risk of fire, do not cover the ventilation opening of the speaker system with newspapers, tablecloths, curtains, etc.

Do not expose the speaker system to naked flame sources (for example, lighted candles).

To reduce the risk of fire or electric shock, do not expose this speaker system to dripping or splashing, and do not place objects filled with liquids, such as vases, on the speaker system.

The AC adaptor and speaker system are not disconnected from the mains as long as they are connected to the AC outlets, even if the speaker system itself has been turned off.

As the mains plugs of the AC power cords and the AC power adaptor are used to disconnect the speaker system from the mains, connect the speaker system to an easily accessible AC outlet. Should you notice an abnormality in the speaker system, disconnect the mains plugs of the AC power cords and the AC power adaptor from the AC outlets immediately.

CAUTION

Risk of explosion if the battery is replaced by an incorrect type. Do not expose batteries or appliances with battery-installed to excessive heat, such as sunshine and fire.

Do not place this product close to medical devices.

This product (including accessories) has magnet(s) which may interfere with pacemakers, programmable shunt valves for hydrocephalus treatment, or other medical devices. Do not place this product close to persons who use such medical devices. Consult your doctor before using this product if you use any such medical device.

For the network connection of the speaker system, establish the connection via the router or LAN port with the router function. If these connections are not established, a security problem may occur.

Indoor use only.

Recommended cables

Properly shielded and grounded cables and connectors must be used for connection to host computers and/or peripherals.

For the control box and the speakers

The nameplate is located on the bottom of the control box and the speakers.

For the AC adaptor

Labels for AC adaptor model number and serial number are located on the bottom of the AC adaptor.



**Disposal of old
electrical &
electronic
equipment
(applicable in the
European Union
and other
countries with
separate**

collection systems)

It should be installed and operated with at least 20 cm and more between the radiator and person's body (excluding extremities: hands, wrists, feet and ankles).

This equipment has been tested and found to comply with the limits set out in the EMC regulation using a connection cable shorter than 3 meters.

Table of Contents

About Manuals of the Speaker System	6
What's in the Box ➔ (separate document)	
What You Can Do with the Speaker System	8
Guide to Parts and Controls	10
Using the Home Menu	14
Setting Up	
Installing the Speaker System	15
Connecting to a TV	16
When Your TV Has the S-CENTER SPEAKER IN Jack	17
Connecting an AV Device	18
Connecting to the AC Outlet (mains)	20
Performing Initial Settings	21
If the Speakers Are not Connected Correctly	22
Watching Images	
Watching TV	24
Playing the Connected AV Device	24
Listening to Music/Sound	
Listening to Sony TV Sound with the BLUETOOTH® Function	25
Listening to Music/Sound with the BLUETOOTH Function	27
Listening to Sound of the Connected TV or Device Using Headphones	29
Listening to Music by Connecting to a Network	
What You Can Do by Connecting the Speaker System to a Network	32
Adjusting the Volume and Sound Quality	
Adjusting the Volume	34
Enjoying Immersive Surround Experience (IMMERSIVE AE)	35
Setting the Sound Effect That Is Tailored to Sound Sources (Sound Mode)	36
Making Dialogs Clearer (VOICE)	37
Enjoying Clear Sound with Low Volume at Midnight (NIGHT)	37
Adjusting the Delay Between the Picture and Sound	38
Enjoying Multiplex Broadcast Sound (AUDIO)	38
Adjusting the Dialog Volume While the DTS:X Content is Played Back	39
Using the Speaker System by Interlocking with a TV	
Operating the Speaker System by Interlocking with a TV (Control for HDMI Function)	40
Operating the Speaker System by Interlocking with a TV Compatible with the "BRAVIA" Sync Function	41
Changing the Settings	
Changing the Brightness of the Front Panel Display and Indicators (DIMMER)	43
Saving Power in Standby Mode	44
Performing Easy Setup	44
Performing Advanced Settings	45
Updating the Software	46

Troubleshooting

Troubleshooting	47
Resetting the Speaker System	55

Additional Information

Specifications	57
Supported Input Audio	
Formats	59
On BLUETOOTH	
Communication	60
Precautions	61
Copyrights and Trademarks	62
Index	65

About Manuals of the Speaker System

The information included in each manual is as shown below.

Startup Guide



Introduces the initial procedures concerning installation and connection for using the speaker system, and operations until you play music.

Operating Instructions (this document)



Explains the basic operations.

- Connection with a TV or other devices
- Playback for music/sound of devices connected with an HDMI cable or the BLUETOOTH function
- Sound adjustment, etc.

Help Guide (Web manual)

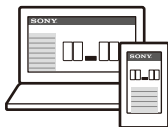

For customers in Americas

https://rd1.sony.net/help/ht/a9/h_uc/



For customers in other countries/
regions

https://rd1.sony.net/help/ht/a9/h_zz/



Provides all operations including advanced usage.

- Playback for music/sound with the network function
- Details on menu items, etc.

Tips

- The instructions in these manuals describe operations using the controls on the remote control.
- Characters in brackets [] appear on the TV screen or front panel display.
- Details are omitted from the illustrations.

What's in the Box

Refer to Startup Guide (separate document).

What You Can Do with the Speaker System

The speaker system supports object-based audio formats such as Dolby Atmos and DTS:X as well as HDR video formats such as HDR10, HLG, and Dolby Vision.

TV

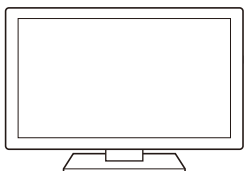

- "Watching TV" (page 24)
- "Listening to Sony TV Sound with the BLUETOOTH® Function" (page 25)



Blu-ray Disc™ player, set-top box, gaming console, etc.

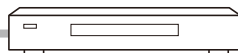

"Playing the Connected AV Device" (page 24)

Headphones



"Listening to Sound of the Connected TV or Device Using Headphones" (page 29)

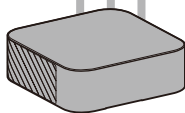

Mobile device

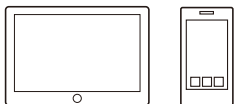

"Listening to Music/Sound with the BLUETOOTH Function" (page 27)



Supplied speakers

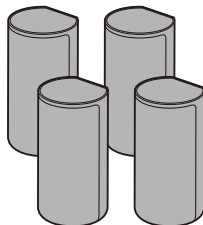

Network

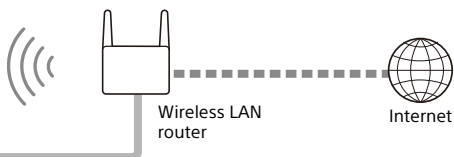

"What You Can Do by Connecting the Speaker System to a Network"
(page 32)

For the connecting method to the network and functions enabled with the network connection, refer to Help Guide (Web manual).

For customers in Americas

https://rd1.sony.net/help/ht/a9/h_uc/



For customers in other countries/regions

https://rd1.sony.net/help/ht/a9/h_zz/



Optional subwoofer

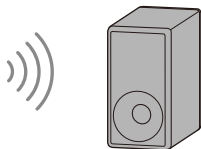

For the operations of the optional subwoofer, refer to its operating instructions.

For the supported optional subwoofer, confirm on the Sony website.

Guide to Parts and Controls

Control Box

Front

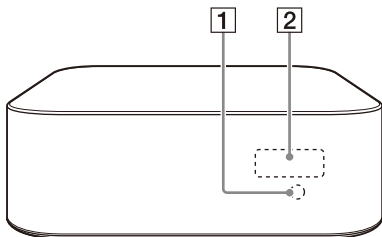

- 1 Remote control sensor**
Point the remote control at the remote control sensor to operate the speaker system.
- 2 Front panel display**
- 3 UPDATE port (page 46)**
Connect the USB memory when updating the speaker system.
- 4 S-CENTER OUT jack (page 17)**
- 5  (power) button**
Turns on the speaker system or sets it to standby mode.
- 6 LAN(100) port**

Rear

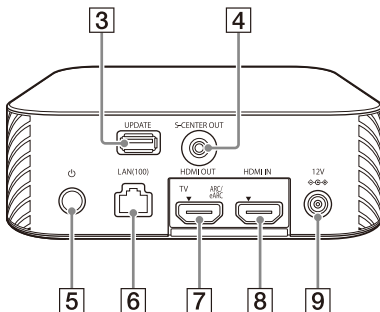

- 7 HDMI OUT (TV ARC/eARC) jack**
Connect a TV that has an HDMI input jack with an HDMI cable. The speaker system is compatible with eARC and ARC. ARC is the function that sends TV sound to an AV device such as the speaker system from the TV's HDMI jack. eARC is an extension of ARC and enables transmission of the object audio and multi-channel LPCM content that cannot be transmitted with ARC.
- 8 HDMI IN jack**
- 9 DC IN terminal**

Speakers

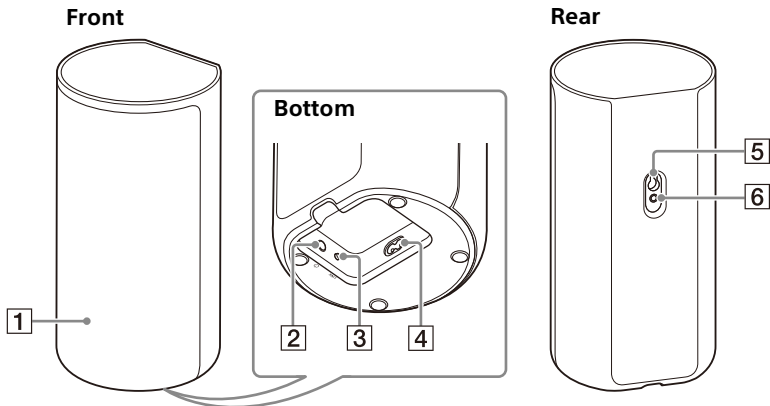

1 Power indicator

Displays the connecting status between the control box and speaker as well as the power condition of the speaker.

Red

– Lights up: The speaker is in standby mode.

Green

– Lights up: The speaker is connected to the control box.

– Flashes slowly: The speaker is attempting to connect to the control box.

– Flashes twice repeatedly: The speaker is in the pairing standby status via manual connection.

Turns off

– The speaker is turned off.

2 (power) button

Turns on/off the speaker.

3 LINK button (page 22)

4 AC inlet

5 Wall mounting hole

6 Mounting hole for the general speaker stand

Note

When using the wall mounting hole (5) or mounting hole for the general speaker stand (6), peel off the cover on them with a safety-pin, etc. (page 15).

Remote Control

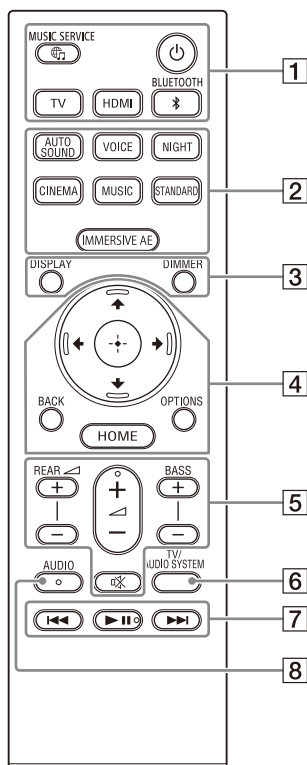

1 (power)

Turns on the speaker system or sets it to standby mode.

(MUSIC SERVICE) button

If you have previously played music on Spotify on the speaker system, you can resume playback by pressing this button.

This button may not be available in some countries/regions.

BLUETOOTH (page 28)

TV (page 24)

HDMI (page 24)

2 AUTO SOUND (page 36)

VOICE (page 37)

NIGHT (page 37)

CINEMA (page 36)

MUSIC (page 36)

STANDARD (page 36)

IMMERSIVE AE (page 35)

3 DIMMER (page 43)

DISPLAY

Displays playback information on the TV screen.

Playback information is displayed in the front panel display for TV input.

4 (page 14)

(enter) (page 14)

BACK (page 14)

OPTIONS (page 39)

Displays the options menu on the TV screen.

The options menu is displayed in the front panel display for TV input.

HOME (page 14)

5 REAR  (rear speakers volume) +/-

Adjusts the volume of the rear speakers.

 **(volume) +/-**

Adjusts the volume.

BASS (bass sound volume) +/-

Adjusts the volume of the bass sound or optional subwoofer when connecting it.

 **(muting)**

Turns off the sound temporarily.

6 TV/AUDIO SYSTEM

Switches the output for the connected TV sound between the TV and speaker system.

Note

This button works in the following conditions.

- The connected TV is compatible with the System Audio Control function.
- The Control for HDMI function of the speaker system is set to on (page 40).

7 Playback operation buttons

  **(previous/next)**



Selects the previous/next track or file.

Pressing and holding it searches backward or forward (rewind/fast forward) during playback.

 **(play/pause)***

Starts, pauses, or re-starts playback (resume play).

8 AUDIO* (page 38)

* The AUDIO,  **(play/pause)**, and  **(volume) +** buttons have a tactile dot. Use it as a guide during operation.

About the replacement of batteries for the remote control

When the speaker system does not respond by operating with the remote control, replace two batteries with new batteries.

Use R03 (size AAA) manganese batteries for replacement.

Using the Home Menu

You can display the home menu on the TV screen by connecting the speaker system and TV with an HDMI cable.

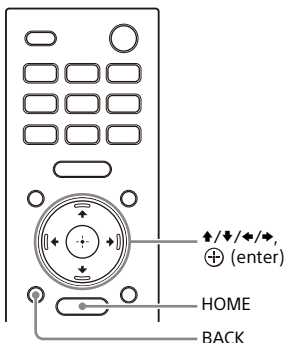

- 3 Press **↕/↔/↔/↕** to select the item that you want, then press **⊕ (enter)**.



The selected input or setting display appears on the TV screen. To return to the previous screen, press **BACK**.

- 1 Press **HOME**.

The home menu appears on the TV screen.

- 2 Press **↕/↔/↔/↕** to select the category that you want, then press **↕** or **⊕ (enter)**.

The items for the selected category appear under the category list on the TV screen.

Category	Explanation
 [Watch]	Selects the input of the TV or AV device that is connected to the speaker system.
 [Listen]	Selects the input of the audio device that is connected to the speaker system or music service for playing back on the speaker system.
 [Setup]	Performs the basic initial settings by using [Easy Setup] or various advanced settings of the speaker system.

Setting Up

Installing the Speaker System

Installing the Control Box and Speakers

For the installation, refer to Startup Guide (separate document).

Mounting the Speakers on a Wall

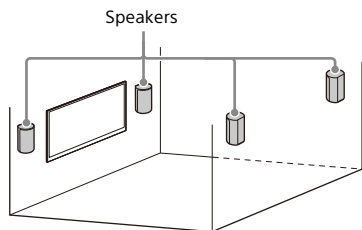

Notes

- Prepare screws (not supplied) that are suitable for the wall material and stability. Depending on the wall material, the wall may be damaged.
- Fasten the screws securely in the wall beam.
- Hang the speakers horizontally on the reinforced wall.
- Have the installation done by a Sony dealer or licensed contractor and pay special attention to safety during the installation.
- Sony shall not be held responsible for accidents or damage caused by improper installation, insufficient wall stability, improper screw installation, natural disasters, etc.

- 1 Prepare screws (not supplied) that are suitable for the wall mounting hole on the rear of the speaker.**

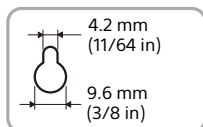
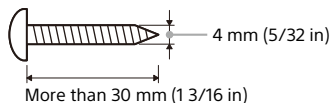

Hole on the rear of the speaker

- 2 Fasten the screw in the wall.**

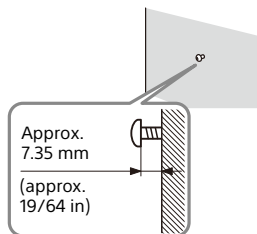

- 3 Peel off the cover on the rear of the speaker with a safety-pin, etc.**

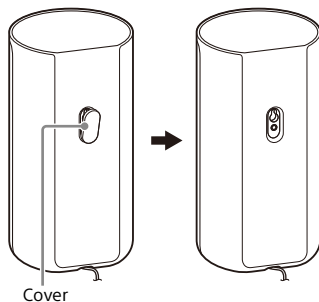

4 Hang the speakers by confirming the type of the speakers.

Check the label on the bottom of the speaker.

- "FL": Front left
- "FR": Front right
- "RL": Rear left
- "RR": Rear right.

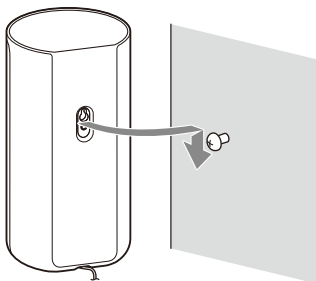

Note

Keep the cover that is peeled off in step 3 for use when you do not mount the speaker on a wall.

Installing the Optional Speakers

Refer to the operating instructions of the optional speakers.

Connecting to a TV

Connecting a TV Compatible with ARC/eARC

- 1 Connect the HDMI IN jack compatible with ARC/eARC on the TV and HDMI OUT (TV ARC/eARC) jack on the speaker system with the HDMI cable (supplied).

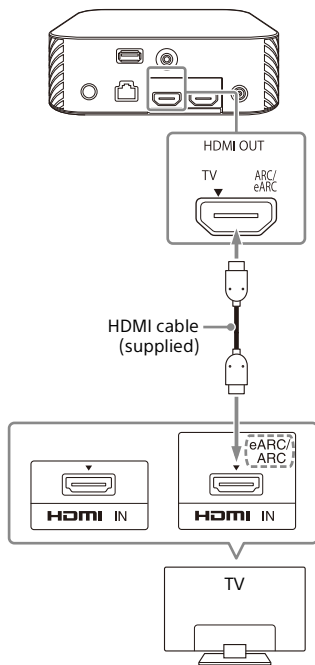

Note

Make sure that the connectors are firmly inserted.

When Your TV Has the S-CENTER SPEAKER IN Jack

You can output the center part of the speaker system sound from the TV by connecting the TV with the following method.

- 1 Connect the speaker system and TV with the HDMI cable (supplied) (page 16).**
- 2 Connect the S-CENTER SPEAKER IN jack on the TV and the S-CENTER OUT jack on the speaker system with the TV center speaker mode cable (supplied).**

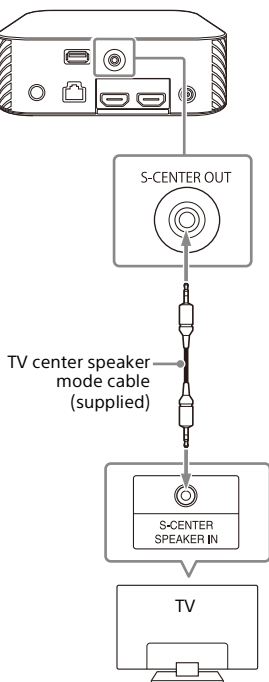

Note

Make sure that the connectors are firmly inserted.

Tip

If the length of the TV center speaker mode cable is not sufficient, use a commercially available stereo mini cable.

Connecting an AV Device

Connecting an AV Device Compatible with the 2K/4K Video Format

You can output sound such as Dolby Atmos, Dolby TrueHD, and DTS:X in high quality by connecting an AV device to the speaker system.

- 1 **Connect the HDMI OUT jack on the AV device and HDMI IN jack on the speaker system with an HDMI cable (not supplied).**

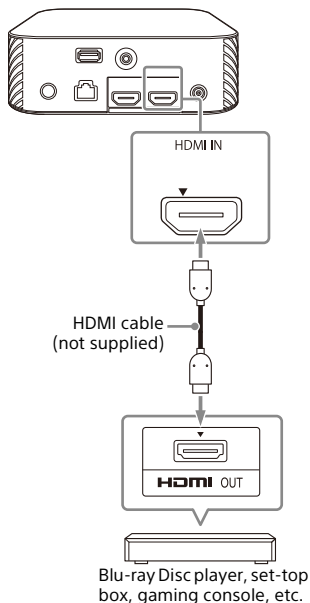

Note

Make sure that the connectors are firmly inserted.

Tips

- If a TV is compatible with eARC, you can also output the high quality sound by connecting an AV device to the HDMI IN jack on the TV. In this case, enable the eARC function of the TV.
- Select the appropriate HDMI cable and [HDMI Signal Format] setting according to the video formats output from the device connected to the speaker system. For details, refer to Help Guide.

Connecting an AV Device Compatible with the 8K Video Format

When you connect an AV device with the following methods, you can play 8K video and high quality sound such as Dolby Atmos, Dolby TrueHD, or DTS:X.

- 1 **Connect the speaker system and TV with the HDMI cable (supplied) (page 16).**
- 2 **Check that the eARC compatible HDMI IN jack on the TV is compatible with the 8K video input.**
Refer to the operating instructions of the TV.
- 3 **Connect an AV device with one of the following methods.**

When the eARC compatible HDMI IN jack on the TV supports the 8K video input:

Connect the HDMI IN jack on the speaker system and HDMI OUT jack on an AV device with an HDMI cable (not supplied).

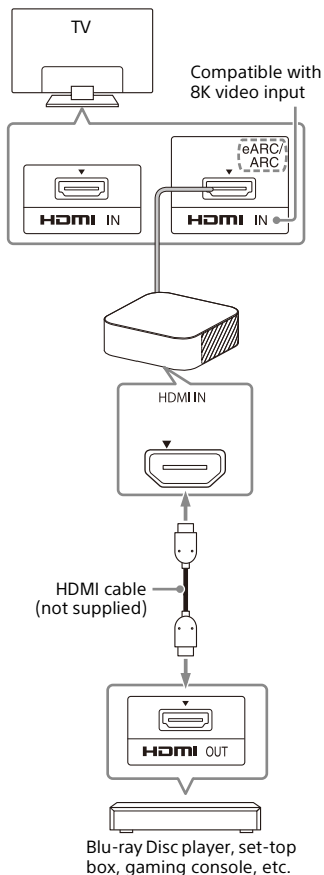

When the eARC compatible HDMI IN jack on the TV does not support the 8K video input:

Connect the HDMI OUT jack on an AV device to the HDMI IN jack compatible with the 8K video input on a TV with an HDMI cable (not supplied).

Make sure that the eARC function of the TV is on.

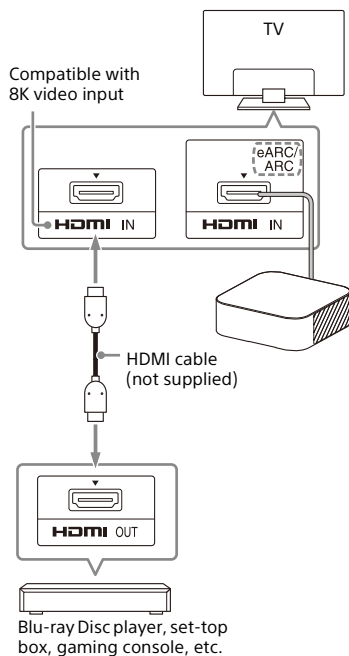

Note

Make sure that the connectors are firmly inserted.

Tip

Select the appropriate HDMI cable and [HDMI Signal Format] setting according to the video formats output from the device connected to the speaker system. For details, refer to Help Guide.

Connecting to the AC Outlet (mains)

- 1 Connect the AC adaptor (supplied) and AC power cord (mains lead) (supplied)* to the DC IN terminal of the control box, then connect to the AC outlet (mains).

*Except for North American models

For North American models

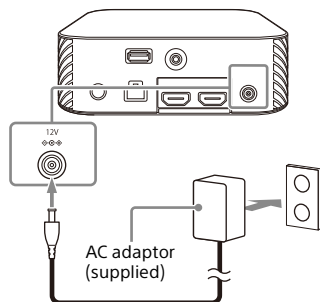

For other models

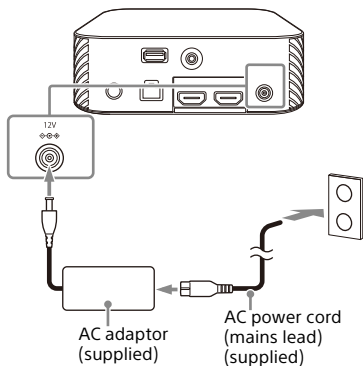

- 2 Connect the AC power cords (mains leads) (supplied) to the AC inlets on four speakers, then connect to the AC outlets (mains).

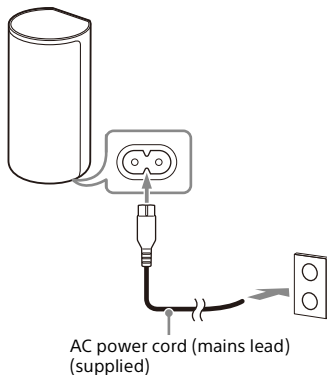

Performing Initial Settings

- 1 Press  (power) on the remote control supplied with the speaker system to turn on the speaker system.

Operate the remote control by pointing it toward the front of the control box.

When the speaker system turns on, [SETUP] appears in the front panel display.

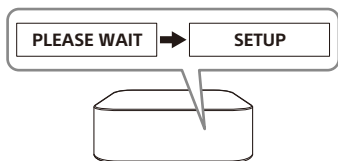
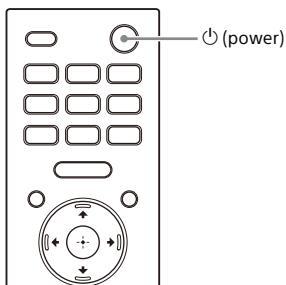

- 2 Turn on the TV.
If the [Speaker connection check] screen does not appear on the TV screen, change the TV input setting to the input that the speaker system is connected.
- 3 Check that the connection between the control box and four speakers is completed on the TV screen.
The control box and speakers are connected automatically.

The sound for connection completion is output after the check marks appear on all the speakers. The power indicator of the speaker lights in green when connecting to the control box.

[ Speaker connection check]



- 4 Perform initial settings by following the on-screen instructions.

[ Language]



[ Sound Field Optimization]



[ Easy Network Setup - Start]

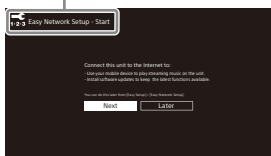

Once [Setup is complete.] appears, select [Finish].

Notes

- Depending on the order in which you turn on the TV and the speaker system, the speaker system may be muted and [MUTING] is displayed on the front panel display of the speaker system. If this happens, turn all devices off, then turn on the speaker system after turning on the TV.
- During [Sound Field Optimization], a measuring sound is output for about 1 minute.
- The speaker system does not output sound until completing the wireless connection between the control box and four speakers.
- If the control box and speakers are not connected automatically in step 3, reset the speakers (page 56).

If the Speakers Are not Connected Correctly

The speakers are connected to the control box automatically when they are turned on.

If you use multiple speaker systems and want to specify the control box that is connected wirelessly to the speakers, perform the manual connection by following the steps below.

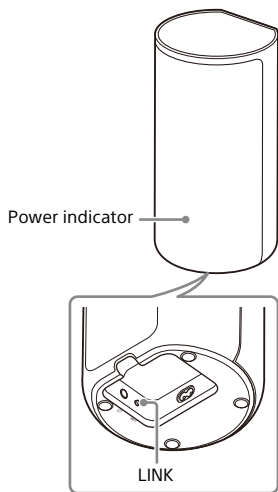

- 1 Press HOME.**
The home menu appears on the TV screen.
- 2 Select  [Setup] - [Advanced Settings] on the home menu.**
- 3 Select [Speaker Settings] - [Wireless Speaker Settings] - [Start manual linking].**
The [Start manual linking] screen appears on the TV screen.

4 Press LINK on all the speakers.

The power indicators of the speakers flash twice repeatedly in green.

5 Select [Start].

The manual connection starts.
The connecting process appears on the TV screen.
To cancel the manual connection, select [Cancel].

6 When all the speakers display [Connected], select [Finish].

7 Press ⊕ (enter).

The manual connection is established and the power indicators of the speakers light in green.

Notes

- If you perform [Start manual linking],  [Setup] - [Advanced Settings] - [Speaker Settings] - [Wireless Speaker Settings] - [Link mode] is set to [Manual] automatically.
- Only the speakers for which [Connected] has been displayed in step 6 connect to the control box. If the connection of the speakers cannot be established, perform the operation again from step 1.

Watching TV

- 1 Press HOME.**
The home menu appears on the TV screen.
- 2 Select  [Watch] - [TV] on the home menu.**
- 3 Select the program using the TV remote control.**
The selected TV program appears on the TV screen and the TV sound is output from the speaker system.
- 4 Adjust the volume (page 34).**

Tip

You can select [TV] directly by pressing TV on the remote control.

Playing the Connected AV Device

- 1 Press HOME.**
The home menu appears on the TV screen.
- 2 Select  [Watch] - [HDMI] on the home menu.**
The image of the selected device appears on the TV screen and the sound is output from the speaker system.
- 3 Adjust the volume (page 34).**

Tip

You can select [HDMI] directly by pressing HDMI on the remote control.

Listening to Sony TV Sound with the BLUETOOTH® Function

What You Can Do by Connecting a TV with the BLUETOOTH Function

When using Sony TV* with the BLUETOOTH function, you can listen to sound of the TV or device that is connected to the TV by connecting the speaker system and TV wirelessly.

* The TV needs to be compatible with A2DP (Advanced Audio Distribution Profile) of the BLUETOOTH profile.

Sony TV

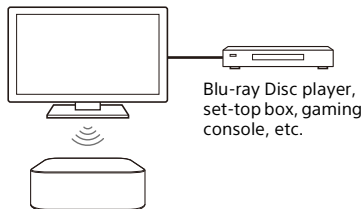

Note

If connecting the speaker system and TV by using the BLUETOOTH function, you cannot display the operation screen for the speaker system such as the home menu on the TV screen, and use functions of the speaker system other than the listening function for the sound of the TV or device that is connected to the TV.

To use all the functions of the speaker system, connect the speaker system and TV with the HDMI cable (supplied) (page 16).

Listening to TV Sound by Connecting the Speaker System and TV Wirelessly

You need to perform pairing of the speaker system and TV by using the BLUETOOTH function.

Pairing is the process required to mutually register the information on BLUETOOTH devices to be connected wirelessly in advance.

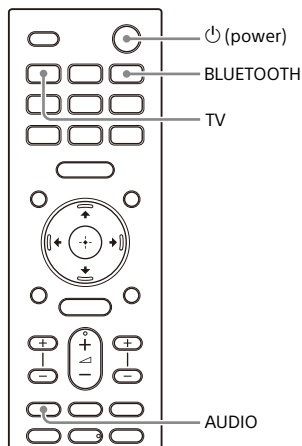

- 1 Turn on the TV.
- 2 Press **power** to turn on the speaker system.
- 3 Press **TV**, **AUDIO**, then **BLUETOOTH** on the remote control in sequence.
- 4 Make sure that **[PAIRING]** appears in the front panel display.

The speaker system enters the BLUETOOTH pairing mode.

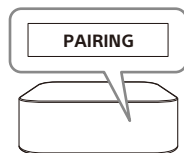

5 On the TV, search the speaker system by performing the pairing operation.

The list of the BLUETOOTH devices that are detected appears on the TV screen.

For the operation method to pair the BLUETOOTH device to the TV, refer to the operating instructions of the TV.

6 Pair the speaker system and TV by selecting "HT-A9" from the list on the TV screen.

7 Make sure that [TV (BT)] appears in the front panel display.

A connection between the speaker system and TV has been established.

8 Select the program or input of the device by using the TV remote control.

The sound of the displayed image on the TV screen is output from the speaker system.

9 Adjust the volume of the speaker system by using the TV remote control.

When pressing the muting button on the TV remote control, the sound is muted temporarily.

Notes

- If the TV sound is not output from the speaker system, press TV and check the status of the front panel display.
 - [TV (BT)] appears in the front panel display: The speaker system and TV are connected, and TV sound is output from the speaker system.
 - [PAIRING] appears in the front panel display: Perform pairing on the TV.
 - [TV] appears in the front panel display: Perform steps from the start.
- When you connect the speaker system and TV with an HDMI cable, the BLUETOOTH connection is canceled. To connect the speaker system and TV with

the BLUETOOTH function again, disconnect the HDMI cable, then perform the connecting operation from the start.

Listening to Sound of the Paired TV

1 Turn on the TV with the TV remote control.

The speaker system is turned on by interlocking with the TV power and TV sound is output from the speaker system.

2 Select the program or input of the device by using the TV remote control.

The sound of the displayed image on the TV screen is output from the speaker system.

3 Adjust the volume of the speaker system by using the TV remote control.

When pressing the muting button on the TV remote control, the sound is muted temporarily.

Tip

When the TV is turned off, the speaker system is also turned off by interlocking with the TV power.

About operations with the remote control that is supplied with the speaker system

You can use the following buttons.

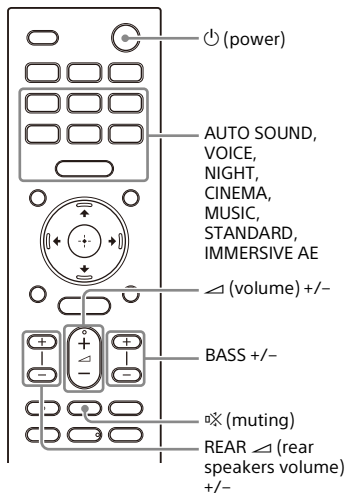

Notes

- If you select the input other than TV on the remote control supplied with the speaker system, the TV sound is not output from the speaker system. To output the TV sound, press TV on the remote control to change to the TV input.
- While the TV is connected with the BLUETOOTH function, the following remote control buttons do not work.
⏪/⏩/⏪/⏩, ⊕ (enter), BACK, HOME, DISPLAY, OPTIONS, ▶|| (play/pause), ⏪/⏩ (previous/next)

Listening to Music/Sound with the BLUETOOTH Function

Listening to Music by Pairing the Mobile Device That Is Connected for the First Time

To use the BLUETOOTH function, you need to perform pairing of the speaker system and mobile device in advance.

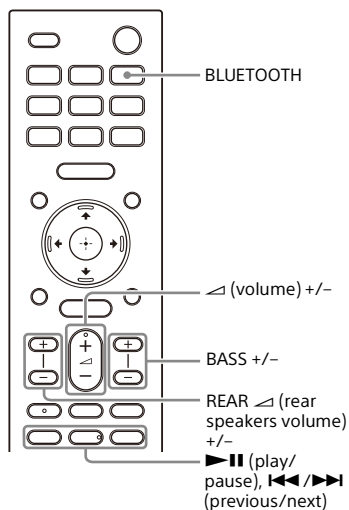

- 1 Press and hold the **BLUETOOTH** button for 2 seconds.

2 Make sure that [PAIRING] appears in the front panel display.

The speaker system enters the pairing mode.



3 On the mobile device, search the speaker system by performing the pairing operation.

The list of the BLUETOOTH devices that are detected appears on the screen of the mobile device. For the operation method to pair the BLUETOOTH device to the mobile device, refer to the operating instructions of the mobile device.

4 Pair the speaker system and mobile device by selecting "HT-A9" from the list on the screen of the mobile device.

If a passkey is requested, enter "0000."

5 Make sure that [BT] appears in the front panel display.

A connection between the speaker system and mobile device has been established.

6 Start audio playback with the music app on the connected mobile device.

Sound is output from the speaker system.

7 Adjust the volume (page 34).

You can play or pause the content by using the playback operation buttons on the remote control.

Tips

- If there is no mobile device that has been paired (ex. immediately after the purchase of the speaker system), the speaker

system goes into pairing mode simply by changing the input to the BLUETOOTH input.

- Perform pairing for the second and subsequent mobile devices.

Listening to Music from the Paired Device

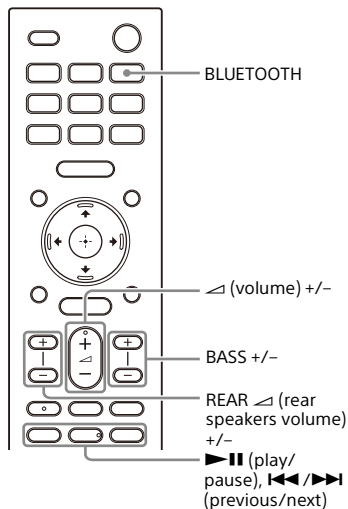

1 Turn the BLUETOOTH function of the mobile device to on.

2 Press the BLUETOOTH button.

The speaker system automatically reconnects to the mobile device it was most recently connected to.

3 Make sure that [BT] appears in the front panel display.

A connection between the speaker system and mobile device has been established.

4 Start audio playback with the music app on the connected mobile device.

Sound is output from the speaker system.

5 Adjust the volume (page 34).

You can play or pause the content by using the playback operation buttons on the remote control.

Note

If sound delay occurs, it may be improved by setting  [Setup] - [Advanced Settings] - [Bluetooth Settings] - [Bluetooth Connection Quality] to [Priority on Stable Connection].

Tip

When the connection is not established, select "HT-A9" on the mobile device.



To disconnect the mobile device

Perform any of the following items.

- Disable the BLUETOOTH function on the mobile device.
- Press the BLUETOOTH button while the [Bluetooth Audio] screen appears on the TV screen.
- Set  [Setup] - [Advanced Settings] - [Bluetooth Settings] - [Bluetooth Mode] to [Transmitter] or [Off].
- Turn off the speaker system or mobile device.

Listening to Sound of the Connected TV or Device Using Headphones

Listening to Sound by Pairing with Headphones

- 1 Set the BLUETOOTH compatible headphones to pairing mode.**
Refer to the operating instructions of the headphones for the pairing method.
- 2 Press HOME.**
The home menu appears on the TV screen.
- 3 Select  [Setup] - [Advanced Settings] on the home menu.**
- 4 Select [Bluetooth Settings] - [Bluetooth Mode] - [Transmitter].**
The speaker system enters BLUETOOTH transmission mode.
- 5 Select the name of the headphones from the [Device List] in [Bluetooth Settings].**
When the BLUETOOTH connection is established, [Connected] appears. If you cannot find the name of your headphones in [Device List], select [Scan].
- 6 Return to the home menu, select  [Watch] or  [Listen], and select the input.**

The image of the selected input appears on the TV screen, [BT TX] appears in the front panel display, then the sound is output from the headphones.

Sound from the speaker system is muted at the same time.

7 Adjust the volume.

Adjust the volume level of the headphones first. Then, adjust the volume level of the headphones with \triangleleft (volume) +/- on the remote control.



To remove the paired headphones from the device list

- 1 Press HOME.
The home menu appears on the TV screen.
- 2 Select  [Setup] - [Advanced Settings] on the home menu.
- 3 Select [Bluetooth Settings] - [Device List].
- 4 Move the cursor to the name of the headphones that you want to remove, and then press DISPLAY.
To remove all the paired headphones from the device list, press AUDIO.
- 5 Follow the on-screen instructions to remove the desired headphones from the device list.

Note



To display the paired headphones on the device list, Set  [Setup] - [Advanced Settings] - [Bluetooth Settings] - [Bluetooth Mode] to [Transmitter].

Listening to Sound with Paired Headphones

- 1 Set the BLUETOOTH function of the headphones to on.
- 2 Press HOME.
The home menu appears on the TV screen.
- 3 Select  [Setup] - [Advanced Settings] on the home menu.
- 4 Select [Bluetooth Settings] - [Bluetooth Mode] - [Transmitter].
The speaker system enters BLUETOOTH transmission mode and the speaker system automatically reconnects to the headphones that was most recently connected to.
- 5 Return to the home menu, select  [Watch] or  [Listen], and select the input.
The image of the selected input appears on the TV screen, [BT TX] appears in the front panel display, then the sound is output from the headphones.
Sound from the speaker system is muted at the same time.
- 6 Adjust the volume.
Adjust the volume level of the headphones first. Then, adjust the volume level of the headphones with \triangleleft (volume) +/- on the remote control.

To disconnect the paired headphones

Perform any of the following items.

- Disable the BLUETOOTH function on the headphones.
- Set  [Setup] - [Advanced Settings] - [Bluetooth Settings] - [Bluetooth Mode] to [Receiver] or [Off].
- Turn off the speaker system or headphones.
- Select the device name of the connected headphones from  [Setup] - [Advanced Settings] - [Bluetooth Settings] - [Device List]. [Connected] of the device name disappears.

About the Connection of the Headphones

- You may not be able to adjust the volume level depending on the BLUETOOTH compatible headphones.
- Input of BLUETOOTH is disabled when  [Setup] - [Advanced Settings] - [Bluetooth Settings] - [Bluetooth Mode] is set to [Off] or [Transmitter].
- You can register up to 9 BLUETOOTH devices. If a 10th BLUETOOTH device is registered, the oldest connected BLUETOOTH device will be overwritten by the new one.
- The speaker system can display up to 15 detected BLUETOOTH devices in the [Device List] (page 30).
- You cannot change the sound effect or settings while transmitting sound to the BLUETOOTH compatible headphones.
- Playback of audio/music on the BLUETOOTH device is delayed compared to that on the speaker system due to the characteristics of BLUETOOTH wireless technology.
- You can enable or disable the reception of LDAC audio from the BLUETOOTH device in [Bluetooth Settings].

What You Can Do by Connecting the Speaker System to a Network

You can perform streaming playback of music content via the speaker system by operating a smartphone, tablet, or iOS device, or play music stored on a computer via the speaker system by connecting to the network.

For details of functions and operations, refer to Help Guide.

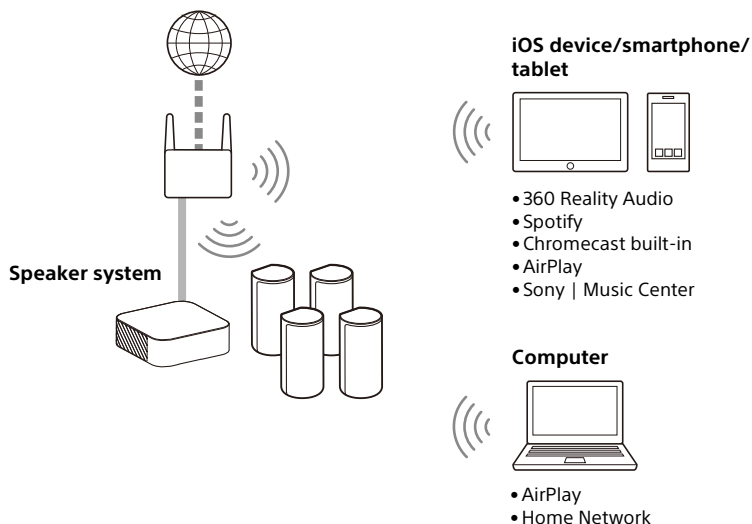

360 Reality Audio

You can play 360 Reality Audio contents on the speaker system by selecting it on the streaming service app compatible with 360 Reality Audio.

Spotify

You can select music on the Spotify app and play it on the speaker system. Use your phone, tablet or computer as a remote control for Spotify. Go to spotify.com/connect to learn how.

Chromecast built-in™

You can select music on the Chromecast-enabled app and play it on the speaker system.

AirPlay

The speaker system supports AirPlay. You can play music on the speaker system by operating an iOS device or a computer.

Sony | Music Center

You can control the speaker system wirelessly by installing the “Sony | Music Center” app on your smartphone or tablet device.

Home Network

You can play music files stored on your computer on a network location via your home network.

Adjusting the Volume and Sound Quality

created from the 2-channel sound using virtual processing. When the input source does not contain much surround sound, the surround sound from the rear speakers may be difficult to hear.

Adjusting the Volume

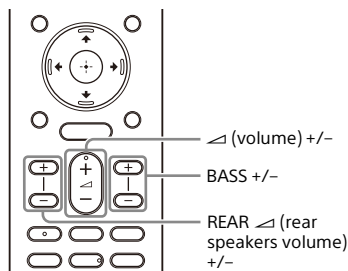

To adjust the speaker system volume

Press \triangle (volume) +/-.
The volume level appears in the front panel display.

To adjust the bass sound volume

Press BASS (bass sound volume) +/-.
The volume level appears in the front panel display.

Note

The subwoofer is designed for playback of bass or low frequency sound. When the input source, such as in TV programs, does not contain much bass sound, the bass sound from the subwoofer may be difficult to hear.

To adjust the rear speaker volume

Press REAR \triangle (rear speakers volume) +/-.
The volume level appears in the front panel display.

Note

The rear speakers are designed for playback of the surround part of the multi-channel sound and surround sound that is

Enjoying Immersive Surround Experience (IMMERSIVE AE)

You can feel immersed by the sound from not only the horizontal direction, but also from the upward direction by working sound modes effectively (page 36). This function also works for the 2.0 channel signal such as TV programs.

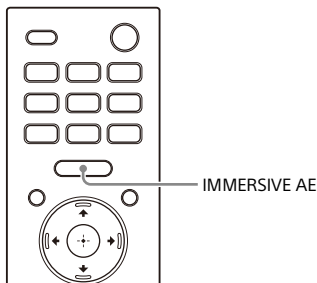

1 Press IMMERSIVE AE to set the function on or off.

The Immersive Audio Enhancement setting appears on the TV screen.

Mode	Explanation
[Immersive Audio Enhancement: On]	Activates the Immersive Audio Enhancement function.
[Immersive Audio Enhancement: Off]	Deactivates the Immersive Audio Enhancement function.

Notes

- The Immersive Audio Enhancement function is available only when  [Setup] - [Advanced Settings] - [Audio Settings] - [Sound Effect] is set to [Sound Mode On].
- The surround effect from all directions differs depending on the sound source.

- The Immersive Audio Enhancement setting does not appear on the TV screen while the TV input is selected. In this case, you can check the Immersive Audio Enhancement setting in the front panel display.
- Depending on the source, this setting is fixed and cannot be changed.

Setting the Sound Effect That Is Tailored to Sound Sources (Sound Mode)

You can easily enjoy pre-programmed sound effects that are tailored to different kinds of sound sources. This function works when  [Setup] - [Advanced Settings] - [Audio Settings] - [Sound Effect] is set to [Sound Mode On].

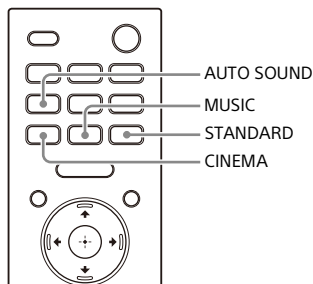

1 Press **AUTO SOUND**, **CINEMA**, **MUSIC**, or **STANDARD** to select the sound mode.

The selected sound mode appears on the TV screen.

Sound mode	Explanation
[Auto Sound]	The appropriate sound setting is automatically selected for the sound source.
[Cinema]	You feel immersed by the sound that travels behind you and surrounds your entire body. This mode is suitable for watching movies.

Sound mode	Explanation
[Music]	Vividness and glossiness of the sound are expressed in detail. This mode is suitable for enjoying music in a way that moves you.
[Standard Surround]	The sound of a TV program can be heard clearly.

Notes

- The sound mode function is disabled in the following conditions.
 - Chromecast built-in is used.
 - AirPlay is used.
 - The BLUETOOTH device is connected in BLUETOOTH transmission mode (page 29).
 - A test tone is emitted.
- The sound mode does not appear on the TV screen while the TV input is selected. In this case, you can check the sound mode in the front panel display.
- Depending on the combination of the sound mode setting and sound source, the effect of [Sound Field Optimization] may not be applied.

Making Dialogs Clearer (VOICE)

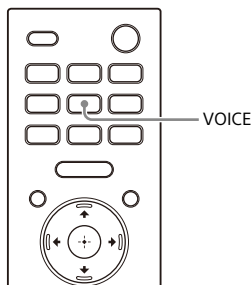

1 Press VOICE to set the function on or off.

The voice mode setting appears on the TV screen.

Mode	Explanation
[Voice: On]	Dialog is easily heard by enhancing dialog range.
[Voice: Off]	Deactivates the voice mode function.

Notes

- The voice mode setting does not appear on the TV screen while the TV input is selected. In this case, you can check the voice mode setting in the front panel display.
- When the BLUETOOTH device is connected in BLUETOOTH transmission mode (page 29), the voice mode is disabled.

Enjoying Clear Sound with Low Volume at Midnight (NIGHT)

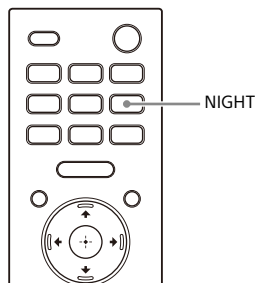

1 Press NIGHT to set the function on or off.

The night mode setting appears on the TV screen.

Mode	Explanation
[Night: On]	Sound is output at low volume with minimum loss of fidelity and clarity of dialog.
[Night: Off]	Deactivates the night mode function.

Notes

- When you turn the speaker system off, this setting is set to [Night: Off] automatically.
- The night mode setting does not appear on the TV screen while the TV input is selected. In this case, you can check the night mode setting in the front panel display.
- When the BLUETOOTH device is connected in BLUETOOTH transmission mode (page 29), the night mode is disabled.

Adjusting the Delay Between the Picture and Sound

When the sound does not match the pictures on the TV screen, you can adjust the delay between the picture and sound.

The setting method differs depending on the input.

For details, refer to Help Guide.

Enjoying Multiplex Broadcast Sound (AUDIO)

You can enjoy multiplex broadcast sound when the speaker system receives a Dolby Digital multiplex broadcast signal.

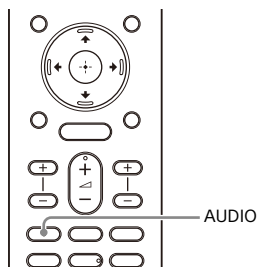

- 1 Press **AUDIO** repeatedly to select the desired audio signal.

The audio signal appears on the TV screen.

Audio signal	Explanation
[Audio: Main]	Sound of the main language is output.
[Audio: Sub]	Sound of the sub language is output.
[Audio: Main/Sub]	Main sound is output from the left speaker and sub sound is output from the right speaker.

Notes

- To output Dolby Digital sound, you need to connect a TV that is compatible with eARC or ARC (page 16) to the HDMI OUT (TV ARC/eARC) jack with the HDMI cable (supplied), or other devices to the HDMI IN jack with an HDMI cable (not supplied).
- The audio signal does not appear on the TV screen while the TV input is selected. In this case, you can check the audio signal in the front panel display.

Adjusting the Dialog Volume While the DTS:X Content is Played Back

By adjusting the dialog volume, you can easily listen to dialog since it stands out from the ambient noise. This function works while playing content that is compatible with the DTS:X dialog control function.

The setting method differs depending on the input.

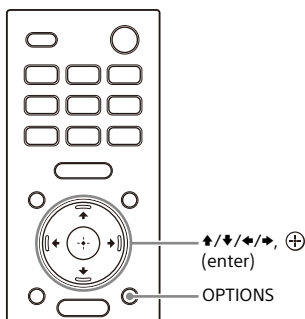

When Playing Content on an AV Device

- 1 Press OPTIONS.**
The options menu appears on the TV screen.
- 2 Select [DTS Dialog Control].**
- 3 Adjust the dialog volume using ↑/↓, then press ⊕ (enter).**
You can adjust from 0.0 dB to 6.0 dB in 1.0 dB increments.

When Watching the TV

- 1 Press OPTIONS, display [DIALOG] in the front panel display using ↑/↓, then press ⊕ (enter).**
- 2 Adjust the dialog volume using ↑/↓, then press ⊕ (enter).**
You can adjust from 0.0 dB to 6.0 dB in 1.0 dB increments.
- 3 Press OPTIONS.**
The options menu in the front panel display turns off.

Using the Speaker System by Interlocking with a TV

Operating the Speaker System by Interlocking with a TV (Control for HDMI Function)

Connecting a TV compatible with the Control for HDMI function using an HDMI cable enables you to interlock the speaker system operation such as power on/off or volume adjustment with a TV.

About the Control for HDMI function

The Control for HDMI function is a function that enables operation of devices connected with an HDMI (High-Definition Multimedia Interface) cable by interlocking them.

Although this function works for devices compatible with the Control for HDMI function, it may not work if connecting devices other than those manufactured by Sony.

Preparing to Operate by Interlocking with a TV

Enable the Control for HDMI function settings of the TV connected to the speaker system with an HDMI cable. The default setting of the Control for HDMI function of the speaker system is [On].

Tips

- When connecting a device such as a Blu-ray Disc player to a TV with an HDMI cable, enable its Control for HDMI function.
- To enable the Control for HDMI function of a TV or Blu-ray Disc player, refer to their operating instructions.

- If you enable the Control for HDMI ("BRAVIA" sync) function when using a TV manufactured by Sony, the Control for HDMI function of the speaker system is also enabled automatically. When the setting is complete, [DONE] appears in the front panel display.

Performing Power Operation or Volume Adjustment by a TV Remote Control

When turning the TV on/off or adjusting the volume using the TV remote control, the speaker system power operation or volume adjustment is interlocked.

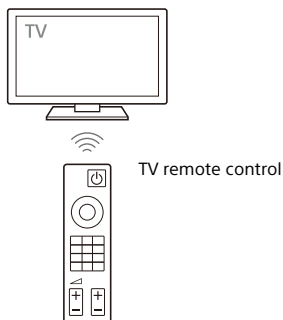

Power interlocking

When you turn on or off the TV, the speaker system will turn on or off automatically.

Note

If you turn off the speaker system before turning off the TV, the speaker system may not turn on automatically even though you turn on the TV next time. In this case, perform the following operation.

- Select the speaker system for the sound output device in the TV menu.
- When using Sony TV, turn on the speaker system while the TV is turned on.

Volume adjustment

The sound of the TV you are watching is output from the speaker system automatically. You can adjust the speaker system volume by the TV remote control.

Other Interlocking Functions

Menu Operation by TV Remote Control

You can operate the menu of the speaker system by selecting the name of the speaker system when changing input or operating the Sync Menu on the TV.

Note

Some Sony TVs support the Sync Menu. Refer to the operating instructions of your TV to see if your TV supports the Sync Menu.

Language Follow

When you change the language for the on-screen display of the TV, the speaker system's on-screen display language is also changed.

One-Touch Play Function

When you play content on a Blu-ray Disc player or "PlayStation®4," etc. connected to the TV, the speaker system and TV are turned on automatically.

Tip

You can change the Control for HDMI settings by selecting  [Setup] - [Advanced Settings] - [HDMI Settings] on the home menu.

Operating the Speaker System by Interlocking with a TV Compatible with the "BRAVIA" Sync Function

"BRAVIA" Sync is an extended function developed by Sony based on the Control for HDMI function. By connecting "BRAVIA" Sync-compatible devices such as a TV or a Blu-ray Disc player using an HDMI cable, you can control the devices by interlocking them with each other.

To use "BRAVIA" Sync

"BRAVIA" Sync is enabled by enabling the Control for HDMI function of the Sony device. For the operation to enable the Control for HDMI function, see "Preparing to Operate by Interlocking with a TV" (page 40).

What You Can Do with "BRAVIA" Sync

Control for HDMI function

- Power interlocking (page 40)
- Volume adjustment (page 41)
- Menu Operation by TV Remote Control (page 41)
- Language Follow (page 41)
- One-Touch Play Function (page 41)

Sound mode/Scene Select Function

The sound mode of the speaker system is automatically switched according to the setting of the TV's Scene Select function or sound mode. To use this function, you need to set the sound mode to [Auto Sound] (page 36).

Home Theatre Control Function

Setting the speaker system, setting the sound mode settings, input switching, etc. can be done without switching the TV input.

Changing the Settings

Changing the Brightness of the Front Panel Display and Indicators (DIMMER)

You can change the brightness of the front panel display and power indicator of the speaker. The brightness of the power indicator for the optional subwoofer also changes.

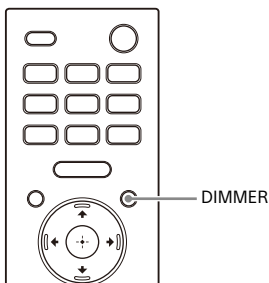

1 Press DIMMER repeatedly to select the desired display mode.

The display mode appears on the TV screen.

Mode	Explanation
[Dimmer: Bright]	The front panel display and indicators light brightly.
[Dimmer: Dark]	The front panel display and indicators light darkly.
[Dimmer: Off]	The front panel display and indicators are turned off.

Notes



- The front panel display and indicators are turned off when [Dimmer: Off] is selected. They turn on automatically when you press any button, then turn off again if you do not operate the speaker system for

about 10 seconds. However, in some cases, the front panel display and indicators may not turn off. In this case, the brightness of the front panel display and indicators are the same as [Dimmer: Dark].

- The display mode does not appear on the TV screen while the TV input is selected. In this case, you can check the display mode in the front panel display.

Saving Power in Standby Mode

Check that you have made the following settings:

-  [Setup] - [Advanced Settings] - [HDMI Settings] - [Standby Through] is set to [Off].
-  [Setup] - [Advanced Settings] - [System Settings] - [Network/Bluetooth Standby] is set to [Off].

Performing Easy Setup

You can make basic initial settings, speaker settings, and network settings for the speaker system easily by performing Easy Setup.

1 Press HOME.

The home menu appears on the TV screen.

2 Select [Setup] - [Easy Setup] on the home menu.

The [Easy Setup] screen appears on the TV screen.

3 Select the desired setting.

- [Easy Initial Setup]: Performs the basic initial settings including the speaker settings and network settings.
- [Easy Sound Setup]: Performs the basic speaker settings for optimizing the surround sound for your environment.
- [Easy Network Setup]: Performs the basic network settings.

4 Perform settings by following the on-screen instructions.

Performing Advanced Settings

Using the [Advanced Settings] Menu

You can make various adjustments to items such as picture and sound on the [Advanced Settings] menu.

1 Press HOME.









The home menu appears on the TV screen.

2 Select [Setup] - [Advanced Settings] on the home menu.

The [Advanced Settings] screen appears on the TV screen.

3 Select the setting item.

For details about the setting items, refer to Help Guide.

Setting item	Explanation
 [Speaker Settings]	Makes the speakers settings for installing and connections.
 [Audio Settings]	Makes the audio output settings.
 [HDMI Settings]	Makes the HDMI settings.
 [Bluetooth Settings]	Makes detailed settings for the BLUETOOTH function.
 [System Settings]	Makes the speaker system-related settings.
 [Network Settings]	Makes detailed settings for the Internet.
 [Resetting]	Resets the speaker system to the factory default settings.
 [Software Update]	Updates the software of the speaker system or optional subwoofer.

Updating the Software

By updating your software to the latest version, you can take advantage of the newest functions.

For information about update functions, visit the following website:

- For customers in Americas
<https://www.sony.com/am/support>
- For customers in Europe
<https://www.sony.eu/support>
- For customers in Asia-Pacific, Oceania, Middle East, and Africa
<https://www.sony-asia.com/support>

Notes

- It may take up to 20 minutes for the update to be completed.
- An Internet environment is necessary to perform updates via the Internet.
- While the updating operation is in progress, do not turn on or off the speaker system, disconnect the AC power cord (mains lead), disconnect/connect an HDMI cable, or operate the speaker system or TV. Wait for the software update to complete.
- Set  [Setup] - [Advanced Settings] - [Network Settings] - [Auto Update Settings] - [Auto Update] to [On] when you want to perform software updates automatically. Software update may be performed even if you select [Off] in [Auto Update] depending on the details of the updates. For details, refer to Help Guide.

- 1 Make sure that the speakers are turned on and connected to the speaker system. When using the optional subwoofer, make sure that it is turned on and connected to the speaker system.**

The power indicators of the speakers and optional subwoofer light in green.

- 2 Press HOME.**

The home menu appears on the TV screen.



- 3 Select  [Setup] - [Advanced Settings] on the home menu.**

If the speaker system detects update information for the speaker system on the network, the update notification and [Software Update] appear on the home menu. In this case, select [Software Update] and follow the on-screen instructions.

- 4 Select [Software Update].**

The [Software Update] screen appears on the TV screen.

- 5 Select the item for updating.**

Select the updating item from the following items by pressing / and , then update the software by following the on-screen instructions.

When a software update starts, the speaker system automatically reboots.

During a software update, [UPDATE] appears in the front panel display. After the update is complete, the speaker system automatically reboots.

[Network Update]

Updates the software using the available network. Make sure that the network is connected to the Internet.

[USB Update]

Updates the software using a USB memory. For details on updating, refer to the instructions that are displayed when downloading the update file.

[Wireless Speakers Update]

Updates the software of the speakers or optional subwoofer when the software of the speaker system is the latest version.

Note

If updating of the speakers or optional subwoofer does not work, move them to a location near the control box and update.

Troubleshooting

If the speaker system does not work properly, handle it in the following order.

1 Search for the cause and solution of the issue by referring to these Operating Instructions or Help Guide.

The troubleshooting method is listed in "Troubleshooting." For the functions that are not mentioned in Operating Instructions, refer to Help Guide.

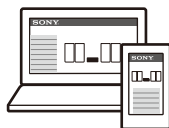

- For customers in Americas

https://rd1.sony.net/help/ht/a9/h_uc/



- For customers in other countries/regions

https://rd1.sony.net/help/ht/a9/h_zz/



2 Search for the cause and solution of the issue on the Sony support site.

Sony support site provides latest support information and Frequently Asked Questions.

- For customers in Americas
<https://www.sony.com/am/support>
- For customers in Europe
<https://www.sony.eu/support>
- For customers in Asia-Pacific, Oceania, Middle East, and Africa
<https://www.sony-asia.com/support>



3 Reset the speaker system.

All the settings of the speaker system return to their initial status.



4 Should any problems persist, consult your nearest Sony dealer.

Be sure to bring your control box and speakers, even if it seems as though only one has a problem, when you request to repair.



Power

The speaker system does not power up.

- Check that the AC power cord (mains lead) is connected securely.
- Disconnect the AC power cord (mains lead) from the wall outlet (mains), and then reconnect after several minutes.

The speaker system does not turn on even when the TV is turned on.

- Set  [Setup] - [Advanced Settings] - [HDMI Settings] - [Control for HDMI] to [On]. The TV must support the Control for HDMI function (page 40). For details, refer to the operating instructions of your TV.
- Check the speaker settings of the TV. The speaker system power syncs with the speaker settings of the TV. For details, refer to the operating instructions of your TV.
- Depending on the TV, if the sound was output from the speakers of the TV the previous time, the speaker system may not turn on by interlocking with the TV power even when the TV is turned on.

The speaker system turns off when the TV is turned off.

- Check the setting of  [Setup] - [Advanced Settings] - [HDMI Settings] - [Standby Linked to TV]. When [Standby Linked to TV] is set to [On] or [Auto], the speaker system turns off automatically when you turn off the TV.

The speaker system does not turn off even when the TV is turned off.

- Check the setting of  [Setup] - [Advanced Settings] - [HDMI Settings] - [Standby Linked to TV]. To turn the speaker system off automatically, regardless of the input when you turn off the TV, set [Standby Linked to TV] to [On]. The TV must support the Control for HDMI function (page 40).

For details, refer to the operating instructions of your TV.

The speaker system cannot be turned off.

- The speaker system may be in demo mode. To cancel demo mode, reset the speaker system. Press and hold  (power) on the control box for more than 10 seconds (page 55).

Picture

There is no picture or the picture is not output correctly.

- Select the appropriate input (page 24).
- When there is no picture while the TV input is selected, select the TV channel that you want using the TV remote control.
- When there is no picture while the HDMI input is selected, press the playback button of the connected device.
- Disconnect an HDMI cable, then connect it again. Make sure that the cable is firmly inserted.
- When there is no picture from the connected device or the picture from the connected device is not output correctly, change the setting of  [Setup] - [Advanced Settings] - [HDMI Settings] - [HDMI Signal Format] - [HDMI IN]. For details, refer to Help Guide.
- The speaker system is connected to an input device that is not HDCP (High-bandwidth Digital Content Protection) compliant. In this case, check the specifications of the connected device.

The picture on the TV screen is distorted.

- Interference of the wireless function between the TV/other wireless devices and the control box may have occurred. Move the control box, change the direction of the control

box, or install the control box far away from the TV/other wireless devices.

- There is an interference of the frequency band between the wireless LAN and the wireless connection of the speakers. Switch the band of the wireless LAN connection of the TV or device that is playing an image to 2.4 GHz.

3D content from the HDMI IN jack does not appear on the TV screen.

- Depending on the TV or video device, 3D content may not appear. Check the supported HDMI video format. For details, refer to Help Guide.

High definition video signal (4K/60p 4:4:4, 4:2:2 and 4K/60p 4:2:0 10 bit, etc.) from the HDMI IN jack does not appear on the TV screen.

- Depending on the TV or the video device, high definition video signals such as 4K may not appear. Check the video capability and settings of your TV and video device.
- Change the setting of  [Setup] - [Advanced Settings] - [HDMI Settings] - [HDMI Signal Format] - [HDMI IN] according to the video signal that is supported by a connected TV or device. For details, refer to Help Guide.
- When you play high definition video signals such as 4K video content that is protected by copyright, connect the speaker system to the HDMI input jack that supports HDCP2.2 or HDCP2.3 on the TV. For details, refer to the operating instructions of your TV.

An image is not displayed on the entire TV screen.

- The aspect ratio on the media is fixed.

Picture and sound of the device that is connected to the speaker system are not output from the TV when the speaker system is not turned on.

- Set  [Setup] - [Advanced Settings] - [HDMI Settings] - [Control for HDMI]

to [On] on the speaker system, and then set [Standby Through] to [Auto] or [On].

- Turn on the speaker system, and then switch the input for the device playing.
- If connected to devices other than those manufactured by Sony that support the Control for HDMI function, set  [Setup] - [Advanced Settings] - [HDMI Settings] - [Standby Through] to [On].

HDR contents cannot be shown in high-dynamic range.



- Check the settings of the TV and connected device. For details, refer to the operating instructions of your TV and the connected device.
- Depending on the [HDMI Signal Format] setting, an AV device may not be able to output HDR contents in HDR format. Change the setting of  [Setup] - [Advanced Settings] - [HDMI Settings] - [HDMI Signal Format] - [HDMI IN] according to the video format that is supported by the AV device. For details, refer to Help Guide.

Sound

No sound is output from the speaker system.

- Check that the AC power cords (mains leads) of the control box and speakers are connected securely.
- If the power indicator of the speaker is turned off, try the following.
 - Check that the AC power cord (mains lead) of the speaker is connected securely.
 - Press  (power) on the bottom of the speaker to turn on the speaker.
- If the power indicator on the speaker flashes slowly in green or lights in red, try the following.
 - Move the speaker to a location near the control box so that the power

indicator on the speaker lights in green.

- Connect the speaker and control box manually (page 22).
- Check the status of the wireless connection in  [Setup] - [Advanced Settings] - [Speaker Settings] - [Wireless Speaker Settings] - [Check wireless connection].
- It may take about 1 minute until the sound is output if  [Setup] - [Advanced Settings] - [Speaker Settings] - [Wireless Speaker Settings] - [RF Channel] is switched from [Off] to [On].
- Press  (volume) + on the remote control to increase the volume or cancel muting (page 12).
- The speakers may be connected to another compatible device. Try manual connection (page 22).

The speaker system cannot connect to a TV with the BLUETOOTH function.

- When you connect the speaker system and TV with an HDMI cable, the BLUETOOTH connection is canceled.

No TV sound is output from the speaker system.

- Check the type and connection of an HDMI cable or TV center speaker mode cable that is connected to the speaker system and the TV (page 16).
- Disconnect the cables that are connected to the TV and the speaker system, then connect them firmly again. Disconnect the AC power cords (mains leads) of the TV and the speaker system from the AC outlets (mains), then connect them again.
- When the speaker system and TV are connected with an HDMI cable, check the following.
 - The HDMI jack of the connected TV is labeled with "eARC" or "ARC."



- The Control for HDMI function of the TV is set to on.
- The eARC or ARC function of the TV is enabled.
- On the speaker system,  [Setup] - [Advanced Settings] - [HDMI Settings] - [Control for HDMI] is set to [On].

- If your TV is not compatible with eARC, set  [Setup] - [Advanced Settings] - [HDMI Settings] - [eARC] to [Off].
- Switch the input of the speaker system to the TV input.
- Increase the volume on the speaker system or cancel muting.
- If sound of a Blu-ray Disc player, set-top box, gaming console, etc. connected to the TV is not output, connect the device to the HDMI IN jack of the speaker system and switch input of the speaker system to the input for the connected device ([HDMI]) (page 18).
- Depending on the order in which you turn on the TV and the speaker system, the speaker system may be muted and [MUTING] is displayed on the front panel display of the speaker system. If this happens, turn on the TV first, then the speaker system.
- Press TV/AUDIO SYSTEM on the remote control to switch the output for the connected TV sound or set the speakers setting of your TV to Audio System. Refer to the operating instructions of your TV regarding how to set the TV.



The sound skips or noise is generated.

- If a device that generates electromagnetic radiation, such as a wireless LAN device or a microwave oven is nearby, move the speaker system away from the device.
- Interference may occur by a wireless LAN connection of a peripheral device. Change the network

connection of the peripheral device to the wired LAN.

- The control box and speakers are installed too far away from each other. Bring them closer together.
- If there is any obstacle between the control box and speakers, remove it or move the control box and speakers away from the obstacle.
- Do not install the control box in the inner position of a shelf. Install the control box in or on a shelf so that the front panel display is not hidden.
- Move the control box, change the direction of the control box, or install the control box far away from a TV.
- Set  [Setup] - [Advanced Settings] - [Speaker Settings] - [Wireless Speaker Settings] - [Wireless Playback Quality] to [Connection].
- Set  [Setup] - [Advanced Settings] - [Speaker Settings] - [Wireless Speaker Settings] - [RF Channel] to [Off], then set to [On].
- Interference of wireless bandwidth between the network connection and speaker connection may occur. Change the wireless LAN connection of the speaker system to the wired LAN connection, or switch the band of the wireless LAN connection to 2.4 GHz.

Picture and sound of the device that is connected to the speaker system are not output from the TV when the speaker system is not turned on.

- Set  [Setup] - [Advanced Settings] - [HDMI Settings] - [Control for HDMI] to [On] on the speaker system, and then set [Standby Through] to [Auto] or [On].
- Turn on the speaker system, and then switch the input for the device playing.
- If connected to devices other than those manufactured by Sony that support the Control for HDMI function, set  [Setup] - [Advanced Settings]

- [HDMI Settings] - [Standby Through] to [On].

The sound is output from both the speaker system and TV.

- Mute the sound of the speaker system or TV.
- When you connect the speaker system and TV with the TV center speaker mode cable and set  [Setup] - [Advanced Settings] - [Speaker Settings] - [TV Center Speaker Mode] to [On], the center part of the speaker system sound is output from the TV. For detail, refer to Help Guide.

The sound is interrupted while watching a TV program or content on a Blu-ray Disc, etc.



- Check the sound mode setting (page 36). If the sound mode is set to [Auto Sound], the sound may be interrupted when the sound mode is changed automatically according to the information of the program that is being played. If you do not want to change the sound mode automatically, set the sound mode to a setting other than [Auto Sound].

The TV sound from this speaker system lags behind the image.

- Set the adjustment value of the delay between the picture and sound to 0 msec if it is set to the range between 25 msec and 300 msec. For details, refer to Help Guide.
- A time gap between the sound and picture may occur depending on the sound source. If your TV has a function that delays the image, use it for adjustment. For details, refer to the operating instructions of your TV.

No sound or only a very low-level sound of the device connected to the speaker system is heard.

- Press  (volume) + on the remote control and check the volume level (page 12).

- Press  or  (volume) + on the remote control to cancel the muting function (page 12).
- Make sure the input source is selected correctly. You should try other input sources by pressing the input select button on the remote control (TV/HDMI/BLUETOOTH).
- Make sure that the connectors are firmly inserted.
- When you play content compatible with copyright protection technology (HDCP), sound may not be output from the speaker system.
- Change the setting of  [Setup] - [Advanced Settings] - [HDMI Settings] - [HDMI Signal Format] - [HDMI IN]. For details, refer to Help Guide.

The surround effect cannot be obtained.

- Depending on the input signal and the sound mode setting, surround sound processing may not work effectively. The surround effect may be subtle, depending on the program or disc.
- To play multi-channel audio, check the digital audio output setting on the device connected to the speaker system. For details, refer to the operating instructions of the connected device.

No sound is output from the optional subwoofer.

- It may be improved by setting  [Setup] - [Advanced Settings] - [Speakers] - [Wireless Speaker Settings] - [Wireless Playback Quality] to [Connection].
- Refer to the operating instructions of the optional subwoofer.

Sound is not output from some speakers.

- Some speakers may not output sound depending on the contents or sound mode.

Sound Field Optimization

Sound Field Optimization failed.

- Speakers may not be correctly located. Check the installation location on the labels on the bottom of the four speakers and install them in the correct location.
- Install the speakers upright so that the labels on the bottom of the speakers are directed downwards.
 - If the speaker is installed sideways, Sound Field Optimization cannot be performed properly.
 - If the speaker is installed in an inclined state, the microphone for measurement of the speaker is also inclined and the sound for measurement ceiling distance is output in an inclined state. These may be the cause that the Sound Field Optimization failed.
- Perform Sound Field Optimization again in a situation where the surrounding is quiet.
- Install the speakers with a distance of more than 50 cm (19 3/4 in). If the distance between speakers is too close, Sound Field Optimization cannot be performed properly.
- Bring the speakers closer if the speakers are installed at a distance far away from each other.
- If there is any obstacle between speakers or the microphone for measurement of the speaker is blocked by an obstacle, Sound Field Optimization cannot be performed properly. Remove it if there is any obstacle between speakers or in front of speakers.

Mobile Device Connection

Pairing cannot be achieved.

- Bring this speaker system and the BLUETOOTH device closer together.

- Make sure this speaker system is not receiving interference from a wireless LAN device, other 2.4 GHz wireless devices, or a microwave oven. If a device that generates electromagnetic radiation is nearby, move the device away from this speaker system.

BLUETOOTH connection cannot be completed.

- Make sure that [BT] appears in the front panel display (page 27).
- Make sure the BLUETOOTH device to be connected with is turned on and the BLUETOOTH function is enabled.
- Bring this speaker system and the BLUETOOTH device closer together.
- Pair this speaker system and the BLUETOOTH device again. You may need to cancel the pairing with this speaker system using your BLUETOOTH device first.
- Pairing information may be deleted. Perform the pairing operation again (page 27).

Sound of the connected BLUETOOTH mobile device is not output from the speaker system.

- Make sure that [BT] appears in the front panel display (page 27).
- Bring this speaker system and the BLUETOOTH device closer together.
- If a device that generates electromagnetic radiation, such as a wireless LAN device, other BLUETOOTH devices, or a microwave oven is nearby, move the device away from this speaker system.
- Remove any obstacle between this speaker system and the BLUETOOTH device or move this speaker system away from the obstacle.
- Reposition the connected BLUETOOTH device.
- Switch the wireless LAN frequency of any nearby wireless LAN router or PC to the 5 GHz range.
- Increase the volume on the connected BLUETOOTH device.

Headphones Connection with the BLUETOOTH Function

Pairing cannot be achieved.

- Bring this speaker system and the BLUETOOTH headphones closer together.
- Make sure this speaker system is not receiving interference from a wireless LAN device, other 2.4 GHz wireless devices, or a microwave oven. If a device that generates electromagnetic radiation is nearby, move the device away from this speaker system.

BLUETOOTH connection cannot be completed.

- Make sure that [BT TX] appears in the front panel display (page 29).
- Make sure the BLUETOOTH headphones to be connected with is turned on and the BLUETOOTH function is enabled.
- Bring this speaker system and the BLUETOOTH headphones closer together.
- Pair this speaker system and the BLUETOOTH headphones again. You may need to cancel the pairing for the BLUETOOTH headphones with this speaker system first. See "To remove the paired headphones from the device list" (page 30).
- Pairing information may be deleted. Perform the pairing operation again (page 29).

No sound is output from the connected BLUETOOTH headphones.

- Make sure that [BT TX] appears in the front panel display (page 29).
- Bring this speaker system and the BLUETOOTH headphones closer together.
- If a device that generates electromagnetic radiation, such as a

- wireless LAN device, other BLUETOOTH devices, or a microwave oven is nearby, move the device away from this speaker system.
- Remove any obstacle between this speaker system and the BLUETOOTH headphones, or move this speaker system away from the obstacle.
- Reposition the connected BLUETOOTH headphones.
- Switch the wireless LAN frequency of any nearby wireless LAN router or PC to the 5 GHz range.
- Increase the volume on the connected BLUETOOTH headphones.
- Set  [Setup] - [Advanced Settings] - [Bluetooth Settings] - [Wireless Playback Quality] to [LDAC Stable Connection (Auto)] or [SBC Stable Connection (Auto)].
- Some content may not be output due to content protection.

Remote Control

The remote control of this speaker system does not function.

- Point the remote control at the remote control sensor on the control box (page 10).
- Remove any obstacles in the path between the remote control and the speaker system.
- Replace both batteries in the remote control with new ones if they are weak.
- Make sure you are pressing the correct button on the remote control.

Others

The Control for HDMI function does not work properly.

- Check the connection with the speaker system (page 16).
- Enable the Control for HDMI function on the TV. For details, refer to the operating instructions of your TV.

- Wait a while, and then try again. If you unplug the speaker system, it will take a while before operations can be made. Wait for 15 seconds or longer, and then try again.
- Make sure the devices connected to the speaker system support the Control for HDMI function.
- Enable the Control for HDMI function on the devices connected to the speaker system. For details, refer to the operating instructions of your device.
- The type and number of devices that can be controlled by the Control for HDMI function are restricted by the HDMI CEC standard as follows:
 - Recording devices (Blu-ray Disc recorder, DVD recorder, etc.): up to 3 devices
 - Playback devices (Blu-ray Disc player, DVD player, etc.): up to 3 devices (this speaker system uses one of them)
 - Tuner-related devices: up to 4 devices
 - Audio system (receiver/headphones): up to 1 device (used by this speaker system)

[PRTC], [PUSH], speaker name ([FL], [FR], [RL], [RR], or [SUB]), and [POWER] flash alternately in the front panel display.

- Press  (power) on the corresponding speaker ([FL]: left front speaker, [FR]: right front speaker, [RL]: left rear speaker, [RR]: right rear speaker, [SUB]: optional subwoofer) to turn each off. For the speaker, disconnect the AC power cord (mains lead), then restart the speaker system. For the optional subwoofer, disconnect the AC power cord (mains lead) and make sure nothing is obstructing the ventilation holes of the optional subwoofer, then restart the speaker system. If they are reconnected properly, the display in the front panel display returns to the normal display.

[HIGH], [TEMP], and [ERROR] appear alternately for 2 seconds each in the front panel display, [STANDBY] appears in the front panel display, then the speaker system is turned off.

→ High-temperature is detected in the speaker system. Press  (power) to restart the speaker system.

[BT TX] appears in the front panel display.

→ Set  [Setup] - [Advanced Settings] - [Bluetooth Settings] - [Bluetooth Mode] to [Receiver]. [BT TX] appears in the front panel display if [Bluetooth Mode] is set to [Transmitter].

Wireless functions (wireless LAN, the BLUETOOTH function, speakers, or optional subwoofer) are unstable.

→ Do not place metal objects other than a TV around the speaker system.

The speaker system restarts.

→ When connecting to a TV with a resolution that is different from that of the speaker system, the speaker system may restart to reset the picture output setting.

Resetting the Speaker System

If the speaker system still does not operate properly, reset the speaker system as follows.

- 1 Press HOME.**
The home menu appears on the TV screen.
- 2 Select  [Setup] - [Advanced Settings] on the home menu.**
- 3 Select [Resetting].**
- 4 Select the menu item you want to reset.**
- 5 Select [Start].**

To cancel resetting

Select [Cancel] in step 5.

If You Cannot Perform Resetting Using the Home Menu

- 1 Press and hold  (power) on the control box for more than 10 seconds.**

The settings return to their initial status.

Note

By resetting, the link with the speakers and optional subwoofer may be lost. In this case, reconnect the speakers (page 22) and optional subwoofer by referring to its operating instructions.

Resetting the Speakers

- 1 Press and hold  (power) on the bottom of the speaker for more than 10 seconds.**

The power indicator of the speaker flashes slowly in red and resetting starts.

The power indicator of the speaker flashes in green and orange alternately when resetting is completed.

When resetting is completed, disconnect the AC power cord (mains lead), then connect the AC power cord (mains lead) after the power indicator turns off.

Additional Information

Specifications

Speakers (SA-FLA9/SA-FRA9/SA-RLA9/SA-RAA9)

The following descriptions are the specifications per speaker.

Amplifier section

POWER OUTPUT (rated)

Top speaker: 35 W (at 6 ohms, 1 kHz, 1% THD)

Tweeter: 25 W (at 6 ohms, 10 kHz, 1% THD)

Woofer: 35 W (at 6 ohms, 100 Hz, 1% THD)

POWER OUTPUT (reference)

Top speaker: 42 W (at 6 ohms, 1 kHz)

Tweeter: 42 W (at 6 ohms, 10 kHz)

Woofer: 42 W (at 6 ohms, 100 Hz)

Front speaker section

Speaker system

2way speaker system bass reflex type

Woofer

70 mm × 82 mm cone type

Tweeter

19 mm soft dome type

Top speaker section

Speaker system

Full range speaker system acoustic suspension type

Speaker

46 mm × 54 mm cone type

General

Power requirements

220 V - 240 V AC, 50 Hz/60 Hz

Power consumption

On: 22 W

Stand by mode: 1 W or less

Turned off: 0.5 W or less

Dimensions* (approx.) (w/h/d)

160 mm × 313 mm × 147 mm

* Not including projection portion

Mass (approx.)

2.7 kg

Control Box (TMR-A9WT)

Inputs

HDMI IN*

Outputs

HDMI OUT (TV ARC/eARC)*

S-CENTER OUT

* HDMI IN and HDMI OUT (TV ARC/eARC) jacks support HDCP2.2 and HDCP2.3 protocols. HDCP2.2 and HDCP2.3 are newly enhanced copyright protection technology that is used to protect content such as 4K movies.

HDMI Section

Connector

Type A (19pin)

USB section (For update use only)

⚡ (USB) port: Type A (For connecting USB memory)

LAN section

LAN(100) terminal

100BASE-TX Terminal

Wireless LAN section

Communication system

IEEE 802.11 a/b/g/n/ac

Frequency band

2.4 GHz, 5 GHz

BLUETOOTH section

Communication system

BLUETOOTH Specification version 5.0

Output

BLUETOOTH Specification Power Class 1

Maximum communication range

Line of sight approx. 30 m¹⁾

Maximum number of devices to be registered

9 devices

Frequency band

2.4 GHz band (2.4000 GHz - 2.4835 GHz)

Modulation method

FHSS (Freq Hopping Spread Spectrum)

Compatible BLUETOOTH profiles²⁾

A2DP (Advanced Audio Distribution Profile)

AVRCP (Audio Video Remote Control Profile)

Supported Codecs³⁾

SBC⁴⁾, AAC⁵⁾, LDAC

Transmission range (A2DP)

20 Hz - 40,000 Hz (LDAC sampling frequency 96 kHz with 990 kbps transmission)

20 Hz - 20,000 Hz (Sampling frequency 44.1 kHz)

- 1) The actual range will vary depending on factors such as obstacles between devices, magnetic fields around a microwave oven, static electricity, cordless phone use, reception sensitivity, the operating system, software applications, etc.
- 2) BLUETOOTH standard profiles indicate the purpose of BLUETOOTH communication between devices.
- 3) Codec: Audio signal compression and conversion format
- 4) Abbreviation for Subband Codec
- 5) Abbreviation for Advanced Audio Coding

General

Power requirements

DC 12 V (using the supplied AC adaptor connected to AC 100 V - 240 V, 50 Hz/60 Hz power supply)

Power consumption

On: 15 W

[Network/Bluetooth Standby] - [On]:

Less than 2.4 W

[Network/Bluetooth Standby] - [Off]:

Less than 0.5 W*

* When [Standby Through] is set to [Off], or [Standby Through] is set to [Auto] while the connected TV is turned off.

Dimensions* (approx.) (w/h/d)

150 mm × 52 mm × 150 mm

* Not including projection portion

Mass (approx.)

730 g

Devices you can stream audio from

- iPhone, iPad, or iPod touch with iOS 11.4 or later

- Apple TV 4K or Apple TV HD with tvOS11.4 or later
- HomePod with iOS 11.4 or later
- Mac with either iTunes 12.8 or later or macOS Catalina
- PC with iTunes 12.8 or later

Wireless Transmitter/Receiver Section

Communication system

Wireless Sound Specification version 4.0

Frequency band

5 GHz

Modulation method

OFDM

Supplied Accessories

- Remote control (1)
- R03 (size AAA) battery (2)
- HDMI cable (4K, 8K transmission supported) (1)
- TV center speaker mode cable (1)
- AC adaptor (1), AC power cord (mains lead) (1)
- AC power cord (mains lead) for the speaker (4)
- Startup Guide
- Operating Instructions (this document)

Design and specifications are subject to change without notice.

Supported Input Audio Formats

Supported audio formats differ depending on the input setting of the speaker system. "O" indicates the supported audio format and "-" indicates the unsupported audio format in the table below.

Format	HDMI input	TV input (eARC)	TV input (ARC)
LPCM 2ch	O	O	O
LPCM 5.1ch	O	O	-
LPCM 7.1ch	O	O	-
Dolby Digital	O	O	O
Dolby TrueHD	O	O	-
Dolby Digital Plus	O	O	O
Dolby Atmos	O	O	-
Dolby Atmos - Dolby TrueHD	O	O	-
Dolby Atmos - Dolby Digital Plus	O	O	O
DTS	O	O	O
DTS-ES Discrete 6.1, DTS-ES Matrix 6.1	O	O	O
DTS 96/24	O	O	O
DTS-HD High Resolution Audio	O	O	-
DTS-HD Master Audio	O	O	-
DTS:X	O	O	-

Note

The HDMI IN jack does not support audio formats that contain copy protections, such as Super Audio CD or DVD-Audio.

On BLUETOOTH Communication

- BLUETOOTH devices should be used within approximately 10 meters (33 feet) (unobstructed distance) of each other. The effective communication range may become shorter under the following conditions.
 - When a person, metal object, wall or other obstruction is between the devices with a BLUETOOTH connection
 - Locations where a wireless LAN is installed
 - Around microwave ovens that are in use
 - Locations where other electromagnetic waves occur
- BLUETOOTH devices and wireless LAN (IEEE 802.11 b/g/n) use the same frequency band (2.4 GHz). When using your BLUETOOTH device near a device with wireless LAN capability, electromagnetic interference may occur. This could result in lower data transfer rates, noise, or inability to connect. If this happens, try the following remedies:
 - Use this speaker system at least 10 meters (33 feet) away from the wireless LAN device.
 - Turn off the power to the wireless LAN device when using your BLUETOOTH device within 10 meters (33 feet).
 - Install this speaker system and BLUETOOTH device as close to each other as possible.
- The radio waves broadcast by this speaker system may interfere with the operation of some medical devices. Since this interference may result in malfunction, always turn off the power on this speaker system and BLUETOOTH device in the following locations:
 - In hospitals, on trains, in airplanes, at gas stations, and any place where flammable gasses may be present
 - Near automatic doors or fire alarms
- This speaker system supports security functions that comply with the BLUETOOTH specification to ensure secure connection during communication using BLUETOOTH technology. However,

this security may be insufficient depending on the setting content and other factors, so always be careful when performing communication using BLUETOOTH technology.

- Sony cannot be held liable in any way for damages or other loss resulting from information leaks during communication using BLUETOOTH technology.
- BLUETOOTH communication is not necessarily guaranteed with all BLUETOOTH devices that have the same profile as this speaker system.
- BLUETOOTH devices connected with this speaker system must comply with the BLUETOOTH specification prescribed by the Bluetooth SIG, Inc., and must be certified to comply. However, even when a device complies with the BLUETOOTH specification, there may be cases where the characteristics or specifications of the BLUETOOTH device make it impossible to connect, or may result in different control methods, display or operation.
- Noise may occur or the audio may cut off depending on the BLUETOOTH device connected with this speaker system, the communications environment, or surrounding conditions.

If you have any questions or problems concerning your speaker system, please consult your nearest Sony dealer.

Precautions

On safety

- Should any solid object or liquid fall into the speaker system, unplug the speaker system and have it checked by qualified personnel before operating it any further.
- Do not climb on the speaker system, as you may fall down and injure yourself, or speaker system damage may result.

On power sources

- Before operating the speaker system, check that the operating voltage is identical to your local power supply. The operating voltage is indicated on the nameplate on the bottom of the control box.
- If you are not going to use the speaker system for a long time, be sure to disconnect the speaker system from the wall outlet (mains). To disconnect the AC power cord (mains lead), grasp the plug itself; never pull the cord.
- One blade of the plug is wider than the other for the purpose of safety and will fit into the wall outlet (mains) only one way. If you are unable to insert the plug fully into the outlet, contact your dealer.
- AC power cord (mains lead) must be changed only at a qualified service shop.

On heat buildup

Although the speaker system heats up during operation, this is not a malfunction. If you continuously use this speaker system at high volume, the speaker system temperature at the rear and bottom rises considerably. To avoid burning yourself, do not touch the speaker system.

On placement

- Do not place the speaker system near heat sources or in a place subject to direct sunlight, excessive dust, or mechanical shock.
- Do not place anything at the side of the control box that might block the ventilation holes and cause malfunctions.

- Do not place metal objects other than a TV around the speaker system. Wireless functions may be unstable.
- If the speaker system is being used in combination with a TV, VCR, or tape deck, noise may result and picture quality may suffer. In such a case, place the speaker system away from the TV, VCR, or tape deck.
- Use caution when placing the speaker system on a surface that has been specially treated (with wax, oil, polish, etc.), as staining or discoloration of the surface may result.
- Take care to avoid any possible injury from the corners of the speaker system.
- Keep 3 cm (1 3/16 in) or more space under the speaker system when you hang it on a wall.
- The speakers of this speaker system are not of magnetically shielded type. Do not place magnetic cards on the speaker system or near it.

On operation

Before connecting other devices, be sure to turn off and unplug the speaker system.

If you encounter color irregularity on a nearby TV screen

Color irregularities may be observed on certain types of TV sets.

If color irregularity is observed...

Turn off the TV set, then turn it on again after 15 to 30 minutes.

If color irregularity is observed again...

Place the speaker system further away from the TV set.

On cleaning

Clean the speaker system with a soft, dry cloth. Do not use any type of abrasive pad, scouring powder, or solvent such as alcohol or benzine.

If you have any question or problem concerning your speaker system, please consult your nearest Sony dealer.

Disclaimer regarding services offered by third parties

Network services, content and the (operating system and) software of this product may be subject to individual terms and conditions and changed, interrupted or discontinued at any time and may require fees, registration and credit card information.

Notes on updating

This speaker system allows you to update the software automatically when connected to the Internet via a wireless or wired network.

You can add new features and use the speaker system with more convenience and safety by updating the speaker system. If you do not want to update automatically, you can disable the function by using Sony | Music Center installed on your smartphone or tablet. However, the speaker system may update the software automatically for reasons such as safety, even if this function is disabled. You can also update the software using the settings menu when this function is disabled. For details, refer to Help Guide. You may not use the speaker system while the software is being updated.

Copyrights and Trademarks

This speaker system incorporates Dolby* Digital and the DTS** Digital Surround System.

* Manufactured under license from Dolby Laboratories. Dolby, Dolby Vision, Dolby Atmos, and the double-D symbol are registered trademarks of Dolby Laboratories Licensing Corporation. Confidential unpublished works. Copyright © 2012–2020 Dolby Laboratories. All rights reserved.

**For DTS patents, see <http://patents.dts.com>. Manufactured under license from DTS, Inc. DTS, DTS:X, and the DTS:X logo are registered trademarks or trademarks of DTS, Inc. in the United States and other countries. © 2020 DTS, Inc. ALL RIGHTS RESERVED.

The BLUETOOTH® word mark and logos are registered trademarks owned by Bluetooth SIG, Inc. and any use of such marks by Sony Corporation is under license. Other trademarks and trade names are those of their respective owners.

The terms HDMI, HDMI High-Definition Multimedia Interface, and the HDMI Logo are trademarks or registered trademarks of HDMI Licensing Administrator, Inc.

Google, Google Play, Google Home and Chromecast built-in are trademarks of Google LLC. Google Assistant is not available in certain languages and countries.

Apple, AirPlay, iPad, iPhone and iPod touch are trademarks of Apple Inc., registered in the U.S. and other countries.

Use of the Works with Apple badge means that an accessory has been designed to work specifically with the technology identified in the badge and has been certified by the developer to meet Apple performance standards.

"BRAVIA" logo is a trademark of Sony Corporation.

WALKMAN® and WALKMAN® logo are registered trademarks of Sony Corporation.

"PlayStation" is a registered trademark or trademark of Sony Interactive Entertainment Inc.

MPEG Layer-3 audio coding technology and patents licensed from Fraunhofer IIS and Thomson.

Windows Media is either a registered trademark or trademark of Microsoft Corporation in the United States and/or other countries.

This product is protected by certain intellectual property rights of Microsoft Corporation. Use or distribution of such technology outside of this product is prohibited without a license from Microsoft or an authorized Microsoft subsidiary.

Wi-Fi®, Wi-Fi Protected Access® and Wi-Fi Alliance® are registered trademarks of Wi-Fi Alliance.

Wi-Fi CERTIFIED™, WPA™, and WPA2™ are trademarks of Wi-Fi Alliance.

LDAC™ and LDAC logo are trademarks of Sony Corporation.

LDAC is an audio coding technology developed by Sony that enables the transmission of High-Resolution (Hi-Res) Audio content, even over a Bluetooth connection. Unlike other Bluetooth compatible coding technologies such as SBC, it operates without any down-conversion of the Hi-Res Audio content*, and allows approximately three times more data** than those other technologies to be transmitted over a Bluetooth wireless network with unprecedented sound quality, by means of efficient coding and optimized packetization.

* excluding DSD format contents

**in comparison with SBC (Subband Coding) when the bitrate of 990 kbps (96/

48 kHz) or 909 kbps (88.2/44.1 kHz) is selected

This product contains software that is subject to the GNU General Public License ("GPL") or GNU Lesser General Public License ("LGPL"). These establish that customers have the right to acquire, modify, and redistribute the source code of said software in accordance with the terms of the GPL or the LGPL.

For details of the GPL, LGPL and other software licenses, please refer to [Software License Information] under  [Setup] - [Advanced Settings] - [System Settings] on the product.

The software included in this product contains copyrighted software that is licensed under the GPLv2 and other licenses which may require access to source code. You may find a copy of the relevant source code as required under the GPLv2 (and other licenses) at <http://www.sony.net/Products/Linux/>.

You may obtain the source code as required by the GPLv2 on a physical medium from us for a period of three years after our last shipment of this product by applying through the form at <http://www.sony.net/Products/Linux/>. This offer is valid to anyone in receipt of this information.

Please note that Sony cannot answer or respond to any inquiries regarding the content of this source code.

"TRILUMINOS" and "TRILUMINOS" logo are a registered trademark of Sony Corporation.

The Spotify Software is subject to third party licenses found here: <https://www.spotify.com/connect/third-party-licenses>.

Spotify and Spotify logos are trademarks of the Spotify Group.*

* Depending on the country and region, this function may not be available.

All other trademarks are trademarks of their respective owners.

Index

Buttons

AUDIO 38
BLUETOOTH 27
DIMMER 43
IMMERSIVE AE 35
NIGHT 37
VOICE 37

A

ARC 10
Audio format 59
Audio Return Channel 10

B

BLUETOOTH
 Function 27
 Pairing 27
"BRAVIA" Sync 41

C

Connection (See "Wired connection"
or "Wireless connection" in "Index")
Control for HDMI 40

D

DTS Dialog control 39

E

eARC 10
Easy Setup 44
Enhanced Audio Return Channel 10

I

Immersive Audio Enhancement 35
Initial settings 44
Installation 15

M

Multiplex broadcast sound 38

N

Night mode 37

P

PRTCT 54

R

Remote control 12
Resetting 55

S

Settings
 Resetting 55
 Setting item 45
Software update 46
Sound Mode 36

V

Voice mode 37
Volume 34

W

Wall mount 15
Wired connection
 AV devices 18
 TV 16
Wireless connection
 BLUETOOTH devices 27
 Headphones 29
 TV 25

The software of this system may be updated in the future. To find out details on any available updates, please visit the following URL.
<https://www.sony-asia.com/support>

dts x

LDAC

HDMI

 Chromecast built-in

COMPATIBLE WITH

 **Dolby Vision**

 **Dolby Atmos**



Works with

Apple AirPlay



* 5 0 2 5 2 2 9 2 1 * (1)