



## Television

Reference Guide

GB

參考指南

CT

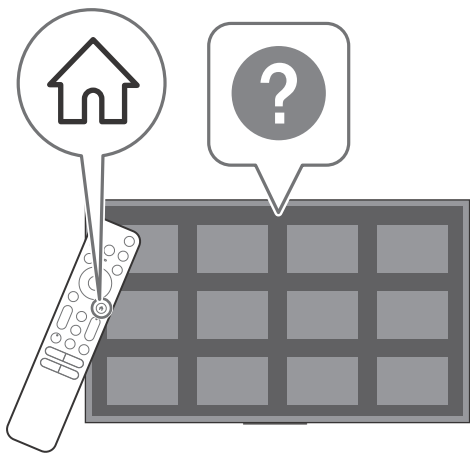

## BRAVIA XR

# About Manuals

This TV comes with the following manuals. Please retain the manuals for future reference.

## Setup Guide

- TV installation and setup.

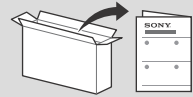

## Reference Guide (this manual) / Safety Documentation

- Safety information, remote control, troubleshooting, wall-mount installation, specification, etc.



## Help Guide (On screen Manual)

- Settings, functions, Internet connection, troubleshooting, etc.
- To open it, press  (Input select) on the remote control and select [Help]. If [Help] does not exist, select [Edit] and add [Help].

- You can refer to the Help Guide with your smartphone.



[https://rd1.sony.net/help/tv/jga1/h\\_ga/](https://rd1.sony.net/help/tv/jga1/h_ga/)

**IMPORTANT – Read the End User Software Licence Agreement before using your Sony product.** Using your product indicates your acceptance of the End User Software Licence Agreement. The software licence agreement between you and Sony is available online at Sony website (<https://www.sony.net/tv-software-licenses/>) or on your product screen. Press  (Quick Settings) on the remote control and select [Settings] → [System] → [About] → [Legal information] → [Notices and licences].

## Note

- Before operating the TV, please read the “Safety Information”.
- Read the supplied safety documentation for additional safety information.
- Instructions about “Installing the TV to the Wall” are included within this TV’s instruction manual.
- Images and illustrations used in the Setup Guide and this manual are for reference only and may differ from the actual product.
- Setting menus are subject to change without notice due to software updates.  
For latest information, visit Sony support website.

## Location of the identification label

Labels for the TV Model No. and Power Supply rating are located on the rear of the TV. They can be found by removing the terminal cover.

This television is designed for use in Hong Kong and ensured the usage in Hong Kong only.

## Safety Information

### Installation/Set-up

Install and use the TV set in accordance with the instructions below in order to avoid any risk of fire, electric shock or damage and/or injuries.

### Installation

- The TV set should be installed near an easily accessible AC power outlet (mains socket).
- Place the TV set on a stable, level surface to prevent it from falling over and causing personal injury or property damage.
- Install the TV where it cannot be pulled, pushed, or knocked over.
- Install the TV so that the TV’s Table-Top Stand does not protrude out from the TV stand (not supplied). If the Table-Top Stand protrudes out from the TV stand, it may cause TV set to topple over, fall down, and cause personal injury or damage to the TV.

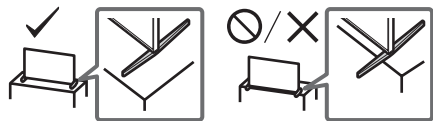

### Transporting

- Before transporting the TV set, disconnect all cables.
- Before transporting the TV set, remove the terminal covers.
- Two or more persons are needed to transport a large TV set.
- When transporting the TV set by hand, hold it as shown below.  
Do not put stress on the panel and the frame around the screen.

- When lifting or moving the TV set, hold it firmly from the bottom.

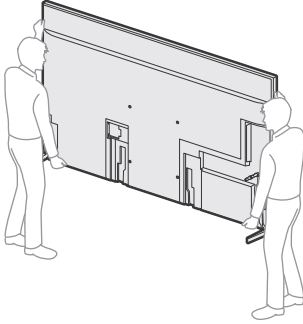

- When transporting the TV set, do not subject it to jolts or excessive vibration.
- When transporting the TV set for repairs or when moving, pack it using the original carton and packing material.

### Topple prevention

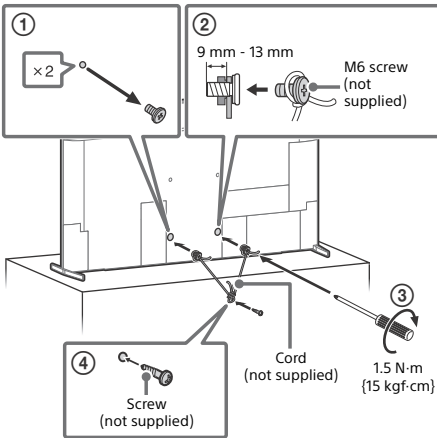

## Using TV as Part of Audio System

### Note

- Before connecting cables, disconnect the AC power cord (mains lead) of both TV and AV receiver.
- Refer to the instruction manual of the Audio system with S-CENTER OUT terminal for detail.

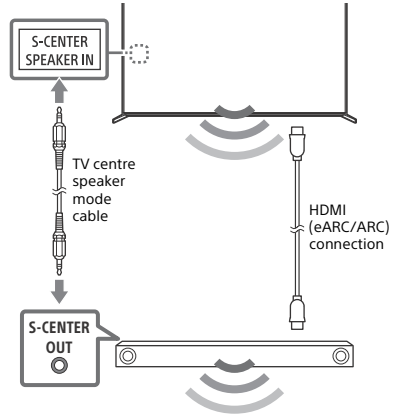

GB

# Remote Control and TV

The remote control shape, layout, and function of remote control buttons may vary depending on your region/country/TV model/TV settings\*1.

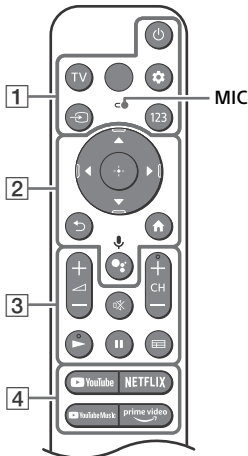

## 1 ⏻ (Power)

**TV:** Display TV channel list or switch to input.

**⚙️ (Quick settings):** Display Quick Settings.

**↶ (Input select):** Display and select the input source, etc.

**123 (Control menu):** Display the Control menu.

## 2 ▲ / ▼ / ◀ / ▶ / ⊕: On screen menu navigation and selection.

↶ (Back)

🏠 (Home)

🗣️ (Google Assistant) / 🎤 (Microphone): Use Google Assistant\*2\*3 or voice search\*3.

## 3 🔊 + / - (Volume)

🔇 (Mute)\*4

CH + / - (Channel)

▶ / ⏸

📺 (Guide): Display the digital programme guide.

## 4 App buttons

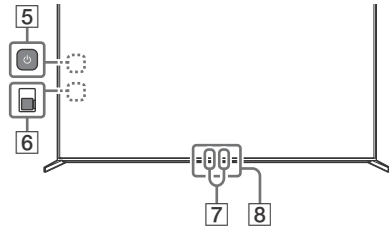

5 ⏻ (**Power**): (It can be found by removing the side cover)

6 **BUILT-IN MIC SWITCH:** Turn on/off the built-in MIC. (It can be found by removing the side cover)

7 **Built-in MIC\*2\*3\*5:** To enable the built-in MIC, press the Google Assistant/microphone button on the remote control and follow the on-screen instructions.

8 **Remote Control sensor / Ambient light sensor / LED**

\*1 For other remote control models, refer to the online Help Guide for details.

\*2 Only for limited region/country/model/language.

\*3 Google Assistant or voice search requires an Internet connection.

\*4 Accessibility shortcut is available by pressing and holding 🔇 (Mute).

\*5 Power consumption will increase when the built-in MIC is enabled as it is always listening.



For more information, refer to the Help Guide.

Press ↶ (Input select) on the remote control and select [Help]. If [Help] does not exist, select [Edit] and add [Help].

## Installing the TV to the Wall

### Using the optional Wall-Mount Bracket (SU-WL850 or SU-WL450)\* (not supplied)

#### To Customers:

For product protection and safety reasons, Sony strongly recommends that installation of your TV be performed by Sony dealers or licensed contractors. Do not attempt to install it yourself.

#### To Sony Dealers and Contractors:

Provide full attention to safety during the installation, periodic maintenance and examination of this product.

#### Wall-Mount Bracket Installation Information

For instructions on Wall-Mount Bracket installation, see the Installation Information (Wall-Mount Bracket) on the product page for your TV model.

<https://www.sony-asia.com/support>

- Follow the instruction guide provided with the Wall-Mount Bracket for your model. Sufficient expertise is required in installing this TV, especially to determine the strength of the wall for withstanding the TV's weight.
- Sony is not liable for any damage or injury caused by mishandling or improper installation.
- Only qualified service personnel should carry out wall-mount installations.
- For safety reasons, it is strongly recommended that you use Sony accessories, including:
  - Wall-Mount Bracket SU-WL850
  - Wall-Mount Bracket SU-WL450
- Be sure to use the screws supplied with the Wall-Mount Bracket when attaching the Wall-Mount Bracket to the TV set. The supplied screws are designed as indicated by illustration when measured from the attaching surface of the Wall-Mount Bracket. The diameter and length of the screws differ depending on the Wall-Mount Bracket model. Use of screws other than those supplied may result in internal damage to the TV set or cause it to fall, etc.

9 mm - 13 mm

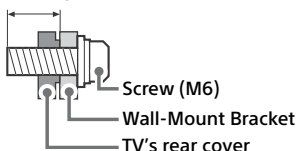

- Be sure to store the unused screws and Table-Top Stand in a safe place until you are ready to attach the Table-Top Stand. Keep the screws away from small children.

\* Only for limited region/country/model.

## Optional Camera and Microphone Unit (not supplied) Cable Management

GB

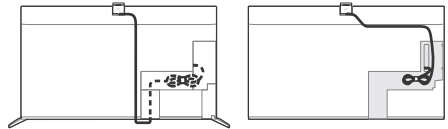

Table-Top Stand position

Wall-mount position

## Troubleshooting

General troubleshooting for issues like: black screen, no sound, frozen picture, TV does not respond, or network is lost, do the following steps.

- 1 Restart your TV by pressing the power button on the remote control for about five seconds. The TV will restart. If the TV does not recover, try unplugging the AC power cord (mains lead) then press the power button on the TV and release it. Wait for two minutes, and plug in the AC power cord (mains lead).  
Or, press the power button on the TV for about 40 seconds until the TV turns off.
- 2 Refer to the Help menu shown below.
- 3 Connect your TV to the Internet and perform a software update. Sony recommends you to keep your TV software updated. Software updates provide new features and performance improvements.
- 4 Visit Sony support website (information provided at the end of this manual).

**When you plug in the TV, the TV may not be able to turn on for a while even if you press the power button on the remote control or the TV.**

It takes time to initialize the system. Wait for about one minute, then operate it again.

**The remote control does not function.**

- Replace the batteries.

**The parental lock password has been forgotten.**

- Enter 9999 for the PIN and enter the new PIN.



For more information on troubleshooting, refer to the Help Guide.  
Press  (Input select) on the remote control and select [Help].  
If [Help] does not exist, select [Edit] and add [Help].

## Specifications

### System

Panel system: LCD (Liquid Crystal Display) Panel, LED Backlight

TV system:

Analogue: I, D/K, B/G, M

Digital: DTMB

Colour system: PAL/SECAM/NTSC3.58/NTSC4.43

Channel coverage:

Analogue: UHF/VHF/Cable

Digital: UHF

Sound output: 10 W + 10 W + 10 W + 10 W + 10 W + 10 W

Wireless technology



Protocol IEEE 802.11a/b/g/n/ac

Bluetooth® Version 4.2

### Input/Output jacks

Antenna (aerial)/cable

75 ohm external terminal for VHF/UHF

 /  VIDEO IN / S-CENTER SPEAKER IN

Video/Audio input (mini jack)

S-centre speaker input (mini jack)

HDMI IN 1/2/3/4 (HDCP 2.3-compatible)

Video:

4096 × 2160p (50, 60 Hz)\*1\*2, 4096 × 2160p (24 Hz)\*1, 3840 × 2160p (50, 60 Hz)\*2, 3840 × 2160p (24, 25, 30 Hz), 1080p (30, 50, 60, 100, 120 Hz), 1080/24p, 1080i (50, 60 Hz), 720p (30, 50, 60 Hz), 720/24p, 576p, 480p, PC Formats\*3  
3840 × 2160p (100, 120 Hz)\*2\*4

Audio:

In eARC (Enhanced Audio Return Channel) mode

Refer to the online Help Guide for details.

Except eARC mode

5.1 channel linear PCM: 32/44.1/48/88.2/96/176.4/192 kHz 16/20/24 bits, Dolby Audio, Dolby Atmos, DTS

eARC/ARC (Enhanced Audio Return Channel/Audio Return Channel) (HDMI IN 3 only)\*5

In eARC mode

Refer to the online Help Guide for details.

In ARC mode



Two channel linear PCM: 48 kHz 16 bits, Dolby Audio, Dolby Atmos, DTS

 DIGITAL AUDIO OUT (OPTICAL)

Digital optical jack (Two channel linear PCM: 48 kHz 16 bits, Dolby Audio, DTS)

 (Stereo mini jack)

Headphone

 1,  2

USB port 1 supports High Speed USB (USB 2.0)

USB port 2 supports Super Speed USB (USB 3.2 Gen 1)

 LAN

10BASE-T/100BASE-TX connector (Depending on the operating environment of the network, connection speed may differ. The communication rate and quality are not guaranteed.)

### Power and others

Power requirements

220 V - 240 V AC, 50 Hz

Screen size (measured diagonally) (Approx.)

65 inches / 163.9 cm

Power consumption

Indicated on the rear of the TV

Standby power consumption\*6\*7

0.5 W

Display resolution (horizontal × vertical) (pixels)

3840 × 2160

Output rating

500 mA (for USB 1), 900 mA (for USB 2)

## Dimensions (Approx.) (w × h × d) (mm)

with Table-Top Stand

Standard position: 1443 × 846 × 343

Narrow position: 1443 × 859 × 343

Soundbar position: 1443 × 907 × 343

without Table-Top Stand

1443 × 835 × 60

## Stand width (Approx.) (mm)

Standard position: 1442

Narrow position: 514

Soundbar position: 1442

## Mass (Approx.) (kg)

with Table-Top Stand

33

without Table-Top Stand

32.1

## Others

Optional accessories

Wall-Mount Bracket: SU-WL850 / SU-WL450

Camera and Microphone Unit: CMU-BC1

Operating temperature: 0 °C - 40 °C

Operating humidity: 10% - 80% RH (non-condensing)

\*1 When 4096 × 2160p is input and [Wide mode] is set to [Normal], the resolution is displayed as 3840 × 2160p. To display 4096 × 2160p, set [Wide mode] setting to [Full 1] or [Full 2].

\*2 Refer to the on screen menu to set [HDMI signal format].

\*3 Refer to the online Help Guide for details.

\*4 HDMI IN 3 & 4 only. Use the Ultra High Speed HDMI Cable to connect.

\*5 Connect your audio system to the HDMI IN 3 to route TV audio to your audio system.

\*6 Specified standby power is reached after the TV finishes necessary internal processes.

\*7 Standby power consumption will increase when your TV is connected to the network.

## Note

- Optional accessories availability depends on countries/region/TV model/stock.
- Design and specifications are subject to change without notice.
- Subscriptions for services and applications may be required and additional terms, conditions and/or charges may apply when using Google Assistant.

## Trademark Information

- The terms HDMI, HDMI High-Definition Multimedia Interface, and the HDMI Logo are trademarks or registered trademarks of HDMI Licensing Administrator, Inc.
- Dolby, Dolby Vision, Dolby Atmos, Dolby Audio, and the double-D symbol are trademarks of Dolby Laboratories Licensing Corporation. Manufactured under license from Dolby Laboratories. Confidential unpublished works. Copyright © 1992-2021 Dolby Laboratories. All rights reserved.
- Gracenote, the Gracenote logo and logotype, "Powered by Gracenote" logo are either registered trademarks or trademarks of Gracenote, Inc. in the United States and/or other countries.
- Google TV is the name of this device's software experience and a trademark of Google LLC. Google, YouTube and other marks are trademarks of Google LLC.
- For DTS patents, see <http://patents.dts.com>. Manufactured under license from DTS, Inc. DTS, Digital Surround, and the DTS logo are registered trademarks or trademarks of DTS, Inc. in the United States and other countries. © 2020 DTS, Inc. ALL RIGHTS RESERVED.
- Netflix is a registered trademark of Netflix, Inc.
- TUXERA is a registered trademark of Tuxera Inc. in the US and other countries.
- All other trademarks are the property of their respective owners.

# 關於說明書

本電視機附帶以下說明書。請保管好這些說明書，以供日後參考。

## 安裝指南

- 電視機安裝和設定。

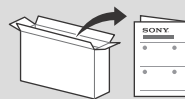

## 參考指南（本說明書） / 安全檔案

- 安全資訊、遙控器、故障排除、壁掛式安裝、規格等。



## 說明指南（電子說明書）

- 設定、功能、網際網路連線、故障排除等。
- 想要打開說明，請按遙控器上的 （輸入選擇），選擇 [ 說明 ]。如果 [ 說明 ] 不存在，請選擇 [ 編輯 ] 並添加 [ 說明 ]。

- 您可以使用您的智能手機來查閱說明指南。



[https://rd1.sony.net/help/tv/jga1/h\\_ga/](https://rd1.sony.net/help/tv/jga1/h_ga/)

**重要 - 在使用 Sony 產品之前，請先閱讀終端使用者軟體授權合約。**若使用您的產品，則表示您接受終端使用者軟體授權合約。您與 Sony 之間的軟體授權合約可在 Sony 網站 (<https://www.sony.net/tv-software-licenses/>) 上線上獲取，也可在您的螢幕上獲取。按遙控器上的 （快速設定），選擇 [ 設定 ] → [ 系統 ] → [ 關於 ] → [ 法律資訊 ] → [ 注意事項和授權 ]。

## 註

- 使用電視機之前，請詳讀“安全資訊”。
- 有關其他安全資訊，請閱讀隨附的安全檔案。
- 有關“將電視機安裝在牆上”的指示已包含在這台電視機的使用說明書。
- 安裝指南和本說明書中使用的影像和插圖僅作參考並可能與實際產品不同。
- 由於軟件更新，設定選單可能變更恕不另行通知。有關最新資訊，請造訪 Sony 支援網站。

## 識別標籤的位置

電視機型號和電源等級的標籤位於電視機背面。拆除端子蓋即可找到這些標籤。

本電視設計在香港使用，只保證能在香港使用。

## 安全資訊

### 安裝 / 設定

為了避免火災、觸電或損壞及 / 或受傷等危險，請遵照下列指示來安裝和使用電視機。

### 安裝

- 應將電視機安裝在易於插拔的 AC 電源插座附近。
- 將電視機放在一個穩定的平面，以防止墜落和引起個人傷害或財產損壞。
- 應將電視機安裝在不容易被拉、推或碰倒之處。

- 安裝電視機，使電視機的桌面底座不會從電視機櫃（非附帶）凸出。如果桌面底座從電視機櫃凸出，可能導致電視機翻倒、掉落及人身傷害或對電視機造成損壞。

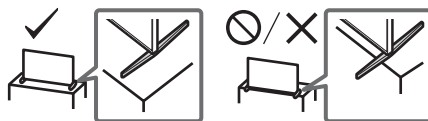

### 搬動

- 搬動電視機之前，請斷開所有纜線的連接。
- 搬動電視機之前，請先拆除端子蓋。
- 大尺寸電視機需要兩人或更多人搬動。
- 用手搬動電視機時，請如下圖所示抓握。請勿對面板以及螢幕周圍的框邊施加壓力。
- 當抬起或搬動電視機時，從底部抱架。

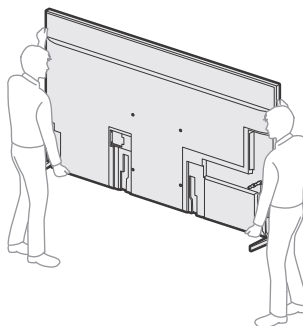

- 搬動電視機時，請勿使其受到搖晃或過度震動。
- 搬動電視機以進行維修或移動時，請使用原有的紙箱和包裝材料進行包裝。



## 防止傾倒

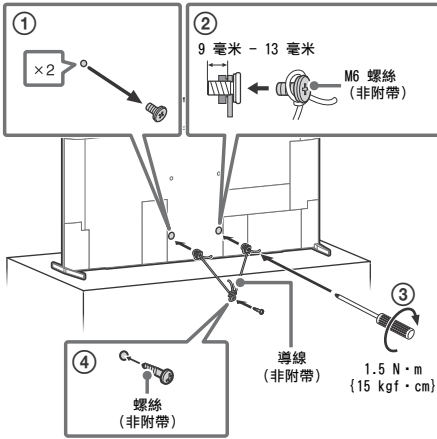

## 將電視機當作音訊系統的一部分使用

### 註

- 連接纜線前，請先斷開電視機與 AV 接收器的 AC 電源線。
- 有關音訊系統 S-CENTER OUT 端子的詳細信息，請參閱使用說明書。

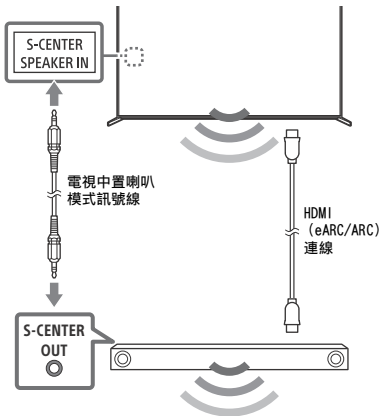

## 遙控器和電視機

遙控器外形、按鈕的佈局、可用性與功能視您的國家 / 區域 / 電視機型號或設定而可能略有不同\*1。

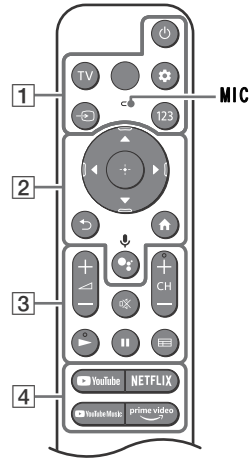

### 1 (電源)

**TV**：顯示電視機頻道清單或切換為輸入。

**⚙ (快速設定)**：顯示快速設定。

**↶ (輸入選擇)**：顯示並選擇輸入來源等。

**123 (控制選單)**：顯示控制選單。

### 2 ▲ / ▼ / ◀ / ▶ / ⊕：在螢幕選單導航和選擇上。

**↶ (返回)**

**⬆ (主選單)**

**🗣 (Google 助理) / 🎤 (麥克風)**：使用 Google 助理\*2\*3 或語音搜尋\*3。

### 3 🔊 + / - (音量)

**🔇 (靜音)\*4**

**CH + / - (頻道)**

**▶ / ⏸**

**📺 (指南)**：顯示數位節目指南。

### 4 應用按鈕

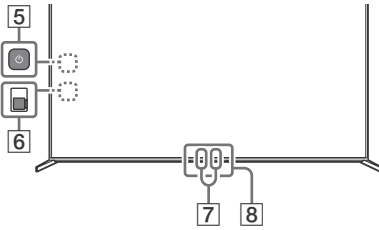

5 ㊦ (電源)：(只要移除側蓋板就能找到)

6 BUILT-IN MIC SWITCH (內建麥克風開關)：開啟 / 關閉內建麥克風。(只要移除側蓋板就能找到)

7 內建麥克風 \*2\*3\*4：若要啟用內建麥克風，請按下遙控器上的 Google 助理 / 麥克風按鈕，並依螢幕上的指示操作。

8 遙控器感應器 / 周遭環境光感應器 / LED

\*1 有關其他遙控器型號，請參閱線上說明指南以獲取詳情。

\*2 僅限用於有限區域 / 國家 / 型號 / 語言。

\*3 使用 Google 助理或語音搜尋需要網際網路連線。

\*4 按住 (靜音) 可使用輔助使用快捷鍵。

\*5 內建麥克風啟用，一直在聆聽時，耗電量會增加。



有關更多资讯，請參閱說明指南。按遙控器上的 (輸入選擇)，選擇 [說明]。如果 [說明] 不存在，請選擇 [編輯] 並添加 [說明]。

- 請遵循適合您的型號的壁掛式支架隨附的使用說明手冊。安裝本電視機須具備充足的專業知識，確定牆壁是否能夠承受電視重量時尤為如此。
- 對於因錯誤操作或安裝不當引致的任何損害，Sony 概不負責。
- 僅可由合格的維修人員執行掛壁安裝。
- 為了安全起見，強烈建議您使用 Sony 配件，包括：

—壁掛式支架 SU-WL850

—壁掛式支架 SU-WL450

- 將壁掛式支架安裝於電視機上時，務必要使用隨附於壁掛式支架的螺絲。隨附螺絲如插圖所示設計從壁掛式支架安裝表面量起。螺絲的直徑和長度會因為壁掛式支架的型號而有所不同。

使用隨附螺絲以外的螺絲可能會造成電視機內部損壞或者掉落等等。

9 毫米 - 13 毫米

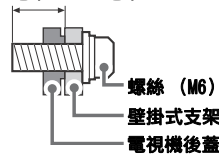

- 務必將未使用的螺絲及桌面底座存放於安全位置，直到您已準備好連接桌面底座。請將螺絲存放在兒童接觸不到的位置。

\* 僅限用於有限區域 / 國家 / 型號。

## 選購的攝影機與麥克風組件 (無附帶) 線材管理

### 將電視機安裝在牆上

使用選購的壁掛式支架 (SU-WL850 或 SU-WL450)\* (非附帶)

致客戶：

出於產品保護及安全原因，Sony 強烈建議由 Sony 經銷商或授權的承包商安裝電視機。請勿嘗試自行安裝電視機。

致 Sony 經銷商和承包商：

安裝、定期維護及檢查本產品時，請充分注意安全。

壁掛式支架安裝資訊

有關壁掛式支架安裝的說明，請參閱您的電視機型號的產品頁上的安裝訊息 (壁掛式支架)。

<https://www.sony-asia.com/support>

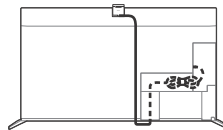

桌面底座位置

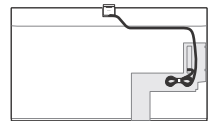

壁掛位置

## 故障排除

以下問題的一般故障排除：黑螢幕、沒有聲音、凍結畫面、電視機沒有反應或網絡丟失，請依照以下步驟操作。

- 1 按遙控器上的電源按鈕大約五秒重新啟動電視機。電視機將重新啟動。如果電視機未恢復正常，請嘗試拔下 AC 電源線，然後按電視機上的電源按鈕再鬆開此按鈕。等候兩分鐘，隨後插入 AC 電源線。  
或者按電視機上的電源按鈕約四十秒，直到電視機關閉。
- 2 請參閱如下所示的說明選單。
- 3 將電視機連接至網路，然後執行軟件更新。  
Sony 建議您不斷更新您的電視機軟件。軟件更新將提供新功能和效能改善。
- 4 造訪 Sony 支持網站（本說明書末尾提供的資訊）。

**在插入電視機時，即使按遙控器或電視機上的電源按鈕，電視機也可能在一定時間不能開啟。**

系統初始化需要一定時間。等待大約一分鐘，然後再次操作。

**遙控器無效。**

- 更換電池。
- 忘記家長鎖定的密碼。
- PIN 碼輸入 9999，然後輸入新的 PIN 碼。



有關故障排除的更多資訊，請參閱說明指南。  
按遙控器上的  (輸入選擇)，選擇 [說明]。如果 [說明] 不存在，請選擇 [編輯] 並添加 [說明]。

## 規格

### 系統

面板系統：LCD（液晶顯示）面板，LED 背光源

電視系統：

模擬：I, D/K, B/G, M

數位：DTMB

彩色系統：PAL/SECAM/NTSC3.58/NTSC4.43

頻道涵蓋範圍：

模擬：UHF/VHF/纜線

數位：UHF

聲音輸出：10 瓦 + 10 瓦 + 10 瓦 + 10 瓦 + 10 瓦 + 10 瓦

無線技術



IEEE 802.11a/b/g/n/ac 協議

藍牙® 版本 4.2

### 輸入 / 輸出插孔

天線 / 纜線

VHF/UHF 的 75 歐姆外接端子

 /  VIDEO IN / S-CENTER SPEAKER IN

視訊 / 音訊輸入（迷你插孔）

S-centre 喇叭輸入（迷你插孔）

HDMI IN 1/2/3/4 (HDCP 2.3 相容)

視訊：

4096 × 2160p (50, 60 Hz)<sup>\*1\*2</sup>, 4096 × 2160p (24 Hz)<sup>\*1</sup>, 3840 × 2160p (50, 60 Hz)<sup>\*2</sup>, 3840 × 2160p (24, 25, 30 Hz), 1080p (30, 50, 60, 100, 120 Hz), 1080/24p, 1080i (50, 60 Hz), 720p (30, 50, 60 Hz), 720/24p, 576p, 480p, PC 格式<sup>\*3</sup>  
3840 × 2160p (100, 120 Hz)<sup>\*2\*4</sup>

音訊：

在 eARC (Enhanced Audio Return Channel) 模式下

有關詳情，請參閱線上說明指南。

eARC 模式除外

5.1 聲道線性 PCM: 32/44.1/48/88.2/96/176.4/192 kHz 16/20/24 位元, Dolby Audio, Dolby Atmos, DTS

eARC/ARC (Enhanced Audio Return Channel / Audio Return Channel) (僅限 HDMI IN 3)<sup>\*5</sup>

在 eARC 模式下

有關詳情，請參閱線上說明指南。

在 ARC 模式下

兩聲道線性 PCM: 48 kHz 16 位元, Dolby Audio, Dolby Atmos, DTS

 DIGITAL AUDIO OUT (OPTICAL)

數位光纖插孔（兩聲道線性 PCM: 48 kHz 16 位元, Dolby Audio, DTS)

 (立體聲迷你插孔)

耳機

## 1、2

USB 連接埠 1 支援高速 USB (USB 2.0)  
USB 連接埠 2 支援超快速 USB (USB 3.2 Gen 1)

## LAN

10BASE-T/100BASE-TX 接頭 (視網絡的作業環境而定, 連線速度可能不同。不保證通訊率和通訊品質。)

## 電源和其他規格

### 電源需求

220 V - 240 V AC, 50 Hz

螢幕尺寸 (對角測量) (大約)

65 英寸 / 163.9 厘米

### 耗電量

見電視機背面

待機耗電量 \*6\*7

0.5 瓦

顯示解析度 (水平 × 垂直) (畫素)

3840 × 2160

### 輸出率

500 mA (對於 USB 1), 900 mA (對於 USB 2)

## 尺寸 (大約) (寬 × 高 × 深) (毫米)

包含桌面底座

標準位置: 1443 × 846 × 343

狹窄位置: 1443 × 859 × 343

條形音箱的位置: 1443 × 907 × 343

不含桌面底座

1443 × 835 × 60

## 底座寬度 (大約) (毫米)

標準位置: 1442

狹窄位置: 514

條形音箱的位置: 1442

## 重量 (大約) (千克)

包含桌面底座

33

不含桌面底座

32.1

## 其他

選用的配件

壁掛式支架: SU-WL850 / SU-WL450

攝影機與麥克風組件: CMU-BC1

作業溫度: 0 °C - 40 °C

操作濕度: 10 % - 80 % 相對濕度 (非冷凝)

- \*1 當輸入 4096 × 2160p 且 [寬螢幕模式] 設為 [正常模式] 時, 解析度將顯示為 3840 × 2160p。要顯示 4096 × 2160p, 請將 [寬螢幕模式] 設定設為 [全螢幕模式 1] 或 [全螢幕模式 2]。
- \*2 請參閱螢幕選單設定 [HDMI 訊號格式]。
- \*3 有關詳情, 請參閱線上說明指南。
- \*4 僅限 HDMI IN 3 & 4。使用 Ultra High Speed HDMI Cable 連接。
- \*5 將音訊系統連接至 HDMI IN 3 以傳送電視機音訊至音訊系統。
- \*6 電視機完成所需的內部處理後, 達到規定的待機功率。
- \*7 當您的電視機連接至網絡時, 待機耗電量將有所增加。

## 註

- 選購配件的供應視國家/區域/電視機型號/存貨而定。
- 設計與規格可能變更而不事先通知。
- 使用 Google 助理時, 可能需要訂購服務和應用程式, 並可能新增適用的條款、條件和/或費用。

## 商標資訊

- HDMI、HDMI 高畫質多媒體介面及 HDMI 標誌為 HDMI Licensing Administrator, Inc. 在美國及其他國家的商標或註冊商標。
- Dolby、杜比、Dolby Vision、Dolby Atmos、Dolby Audio、和雙 D 符號是杜比實驗室特許公司的商標。本產品經過杜比實驗室的許可而製造。未公佈的機密作品。版權所有 © 1992-2021 杜比實驗室。保留所有權利。
- Gracenote、Gracenote 標誌和標誌字型以及 “Powered by Gracenote” 標誌是 Gracenote, Inc. 在美國和/或其他國家的註冊商標或商標。
- Google TV 是該裝置軟件體驗的名稱, 也是 Google LLC 的商標。Google、YouTube 和其他標記是 Google LLC 的商標。
- 有關 DTS 專利, 請參閱 <http://patents.dts.com>。由 DTS, Inc. 授權製造。DTS、Digital Surround、以及 DTS 標誌是 DTS, Inc. 在美國和其他國家的註冊商標或商標。© 2020 DTS, Inc. 保留所有權利。
- Netflix 是 Netflix, Inc. 的註冊商標。
- TUXERA 是 Tuxera Inc. 在美國及其他國家/地區的註冊商標。
- 所有其他商標屬於其各自的所有者。







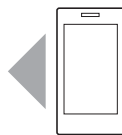

Support  
支援

<https://www.sony-asia.com/support>