

SONY®

# User guide

Xperia Ear Duo  
XEA20

# Contents

<b>Introduction.....</b>	<b>3</b>
General overview.....	3
<b>Hardware overview.....</b>	<b>4</b>
Main units.....	4
Charging case.....	4
<b>LED indicators.....</b>	<b>7</b>
LED indicator for the main units - during use.....	7
LED indicator for the main units - during charging.....	7
Charging case battery level LED - during charging.....	7
Charging case battery level LED - when not connected to a power source.....	7
<b>Getting started.....</b>	<b>8</b>
Charging.....	8
Turning on or off.....	9
Pairing with an Android or iOS device.....	9
Wearing instructions.....	10
<b>Using your Xperia Ear Duo.....</b>	<b>13</b>
Using the touchpad.....	13
Using head gestures.....	14
Calling.....	15
Listening to music.....	16
Adjusting the volume.....	16
Using voice control.....	16
Anytime Talk .....	16
<b>Settings.....</b>	<b>18</b>
Changing the key behaviour.....	18
Setting the sound.....	18
Setting the Assistant.....	18
Resetting the Xperia Ear Duo.....	19
<b>Legal information.....</b>	<b>21</b>
Declaration of Conformity for XEA20.....	22

# Introduction

## General overview

The Xperia Ear Duo offers a new listening experience while letting you stay connected to the world. You can enjoy music, make calls, listen to your schedule, forecasts and more, all while being able to hear your surroundings.

Set up the Xperia Ear Duo with the Xperia Ear Duo host app on an Android™ or iOS device.

# Hardware overview

## Main units

The main unit (R) is symmetrical to the main unit (L). Only the main unit (R) is illustrated here.

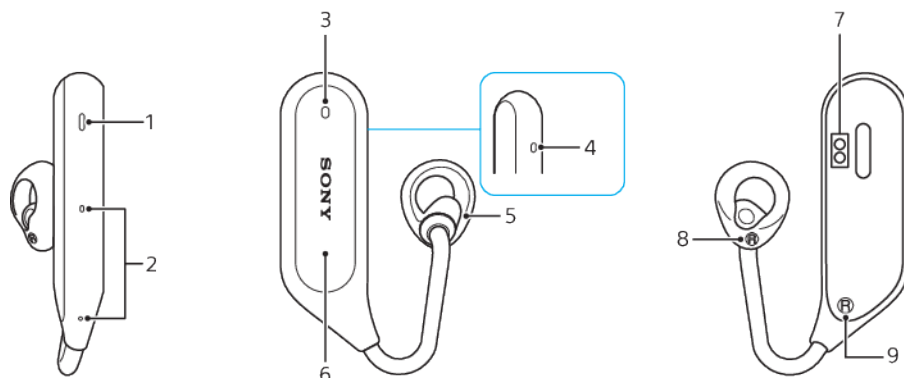

- 1 Sound hole
- 2 Microphone
- 3 LED indicator
- 4 Proximity sensor
- 5 Ring supporter
- 6 Touchpad
- 7 Charging case connector
- 8 Right/left marker for ring supporter
- 9 Right/left marker for main units

! Do not insert foreign objects such as pins and clips into the sound hole.

## Charging case

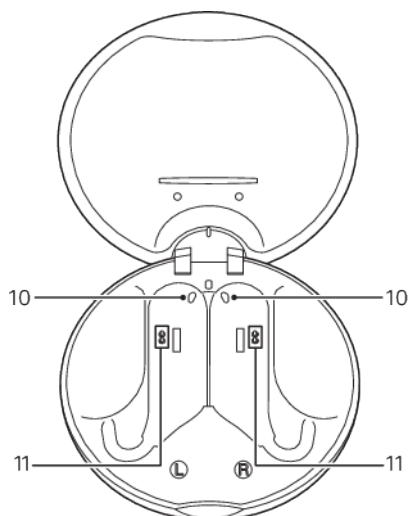

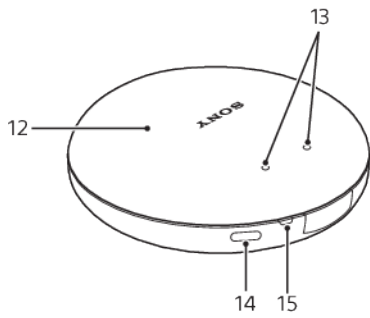

- 10 Device detection switch
- 11 Charging case connector
- 12 Lid
- 13 Window to Xperia Ear Duo battery level LED
- 14 USB Type-C™ port
- 15 Charging case battery level LED

**To attach the lid to the charging case**

! Make sure not to apply too much force when opening the lid of the charging case, so the lid does not become detached. If necessary, reattach the lid as described.

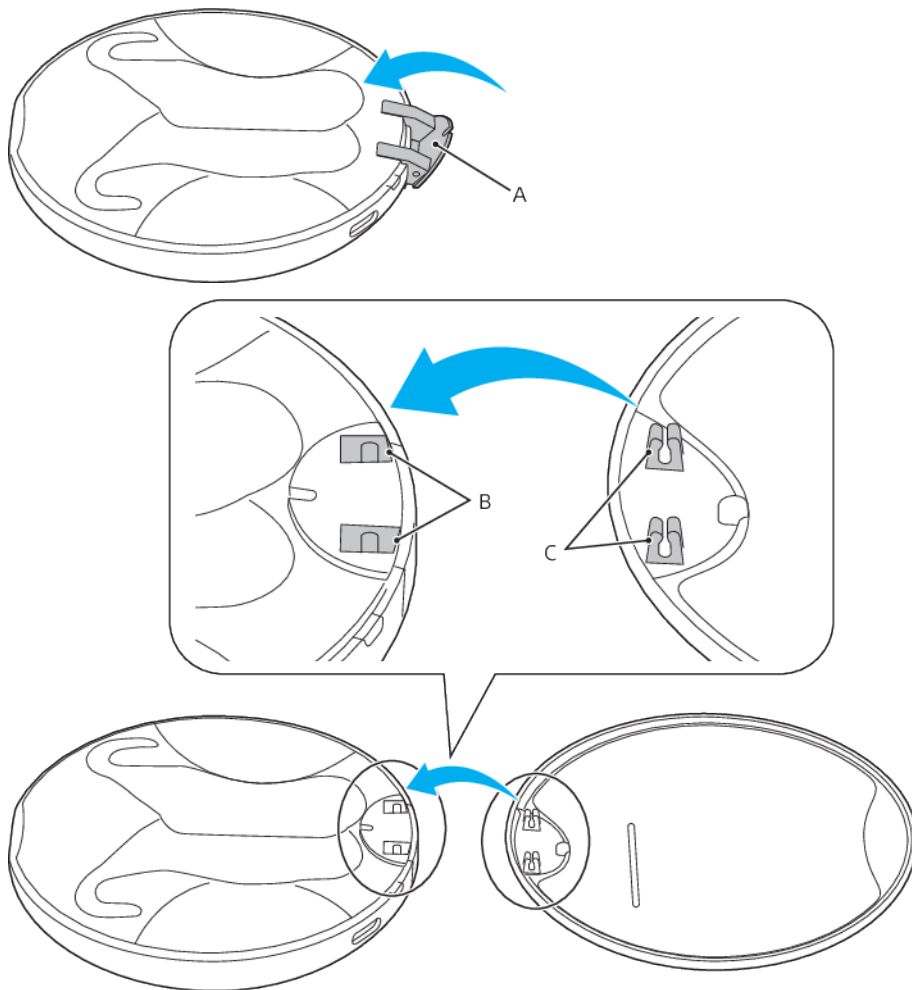

- 1 Push the connection part A on the charging case inward, as shown in the illustration.
- 2 Align connection part B of the charging case with connection part C of the lid, as shown in the illustration.
- 3 Push the connection parts together to attach.
- 4 Press lightly on the connection part while closing the lid, so no gap is formed.

# LED indicators

## LED indicator for the main units - during use

Quick white flashes	Incoming call
One white flash	Pairing completed
Two white flashes	Power on/Restart completed
Quick blue flashes	Pairing mode
Slow blue flashes	Standby mode for Bluetooth® device
Quick red flashes	Low battery, 15% or less

## LED indicator for the main units - during charging

Red	15% or less
Orange	15% – 80%
Green	80% or more
Green flashes	Updating software
No light	Charging complete

-  When the charging case lid is closed, you can check the charging status of the main units through the window to the Xperia Ear Duo battery level LED.

## Charging case battery level LED - during charging

When the charging case is connected to a power source, the LED indicator near the USB port shows the case's battery level.

Red	15% or less
Orange	15% – 80%
Green	80% or more
No light	Charging complete, or no battery left

## Charging case battery level LED - when not connected to a power source

When you place the main units in the charging case, the case's LED shows the battery level of the case even when not connected to a power source.

Three red flashes	15% or less
Three orange flashes	15% – 80%
Three green flashes	80% or more

# Getting started

## Charging

Your Xperia Ear Duo comes with a portable charging case, which itself can be charged by a power outlet. Before using the main units for the first time, you must charge them. The LED indicator turns green when the battery level is above 80%. Drained main units need to charge for approximately 1.5 hours to be fully charged.

The main units and their charging case can be charged together or separately. A fully charged case can charge the main units up to three times.

For the LED indicator status during charging, see *LED indicators* on page 7.

- ! The main units turn off automatically when placed inside the charging case.

### To charge your Xperia Ear Duo

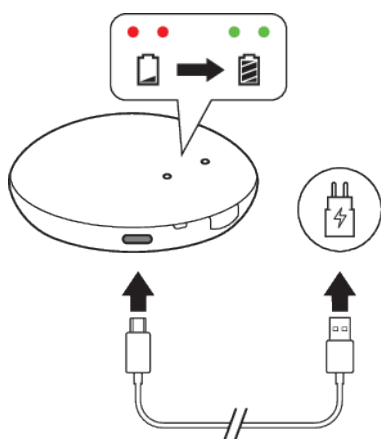

- 1 Place the main units in the charging case.
  - 2 Connect the USB Type-C cable connector to the USB Type-C port of the charging case.
  - 3 Connect the other end of the USB Type-C cable to the charger.
- ! Make sure to place the main units in the charging case with the logo facing up. Placing them in the case at an angle may damage the charging case connector. Placing them in the case upside down may damage the touchpad.

Use a USB Type-C cable (provided) to charge your device. For the recommended charger, see <http://www.sonymobile.com/products/accessories/>.

### To charge the main units only

- Place the main units in the charging case.

### To charge the charging case only

- 1 Without placing the main units into the charging case, connect the USB Type-C cable connector to the USB Type-C port of the charging case.
- 2 Connect the other end of the USB Type-C cable to the charger.

### To check the battery level of your Xperia Ear Duo

- Open the **Xperia Ear Duo** app installed on your Android or iOS device. The battery level is displayed.



## Turning on or off

### To turn on the main units

- Remove the main units from the charging case. The LED on the main unit flashes twice in white.
- 💡 If the main units are turned off but not in the charging case, you can still turn them back on. Touch and hold the touchpad on each unit for at least one second.

### To turn off the main units

- Place the main units in the charging case. When charging is complete, the main units turn off automatically.
- 💡 When the main units are not in the charging case, they turn off automatically after 15-30 minutes when:
  - They are disconnected by turning off Bluetooth in the Setting screen of the paired device.
  - They are too far from the paired device and the Bluetooth connection drops.

## Pairing with an Android or iOS device

For your Xperia Ear Duo to work properly, you must install the latest version of the Xperia Ear Duo app on an Android or iOS device, and then pair it. The Xperia Ear Duo app is available on Google Play™ or the App Store.

Make sure not to cover the proximity sensor with your finger, as this can prevent the main unit from entering pairing mode.

### To pair with an Android device

- ! Xperia Ear Duo can only be paired with Android version 5.0 or later.

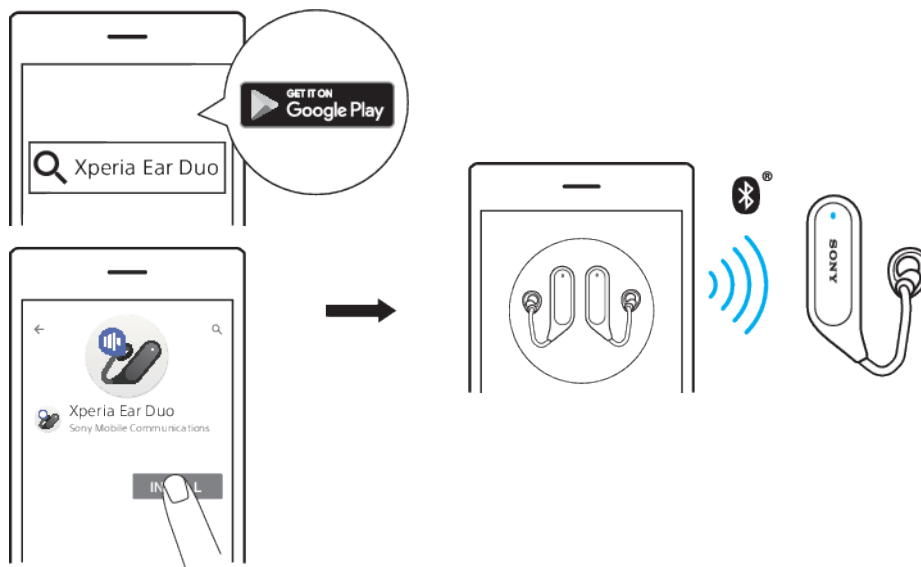

- 1 Android device: Make sure you have the latest version of the **Xperia Ear Duo** app.
- 2 Launch the **Xperia Ear Duo** app and follow the on-screen instructions.
- 3 Xperia Ear Duo: When pairing is complete, the LED indicator on the main unit flashes once in white.

### To pair with an iOS device

- ! Xperia Ear Duo can only be paired with iOS version 10 or later.

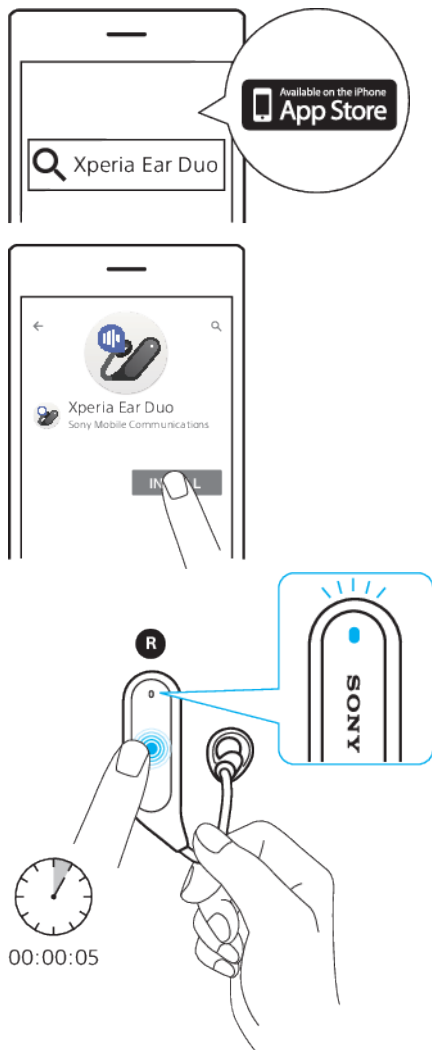

- 1 iOS device: Make sure you have the latest version of the **Xperia Ear Duo** app.
- 2 Turn on Bluetooth.
- 3 Xperia Ear Duo: Touch and hold the touchpad of the main unit (R) for 5 seconds. The LED indicator flashes quickly in blue.
- 4 Bring the main unit (R) and iOS device close to each other.
- 5 iOS device: Scan for Bluetooth devices and select **XEA20** from the list.
- 6 Xperia Ear Duo: When pairing is complete, the LED indicator on the main unit flashes once in white.
- 7 Launch the **Xperia Ear Duo** app and follow the on-screen instructions.

#### To pair with devices other than Android or iOS

- 1 Touch and hold the touchpad of the main unit (R) for 5 seconds. The LED indicator flashes quickly in blue.
- 2 Follow the instructions provided by the device to which you're pairing.
- 3 When pairing is complete, the LED indicator on the main unit flashes once in white.

## Wearing instructions

- ! Check relevant laws and regulations on the use of mobile phones, transmitting devices and earphones before using this device while operating a vehicle or riding a bicycle. Always give your full attention to operating your vehicle or bicycle and the surroundings.

To wear the main units for the first time, follow these steps.

## To wear your Xperia Ear Duo

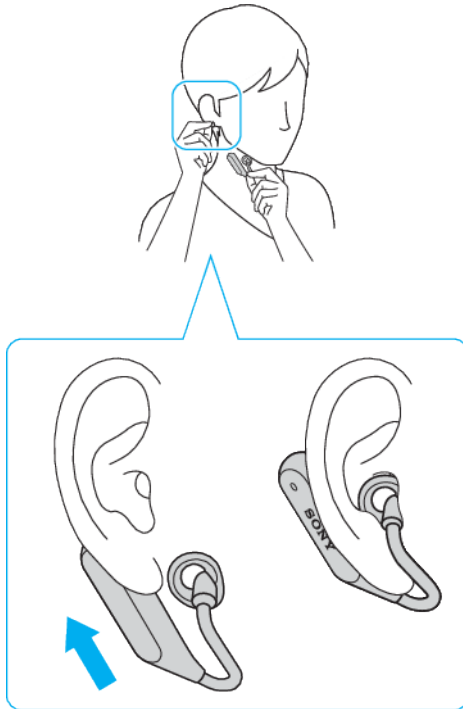

- 1 Hold the main unit (R) with your left hand.
  - 2 Gently pull down your right earlobe with your right hand.
  - 3 Sliding the main unit behind your ear, insert the ring supporter into your ear as shown in the illustration. Adjust the ring supporter so it fits comfortably in your ear.
  - 4 Insert the main unit (L) in the left ear in the same procedure.
- ! Make sure no hair is caught between the proximity sensor window and your ear. If the proximity sensor is covered, it cannot function properly.

## To change the ring supporter

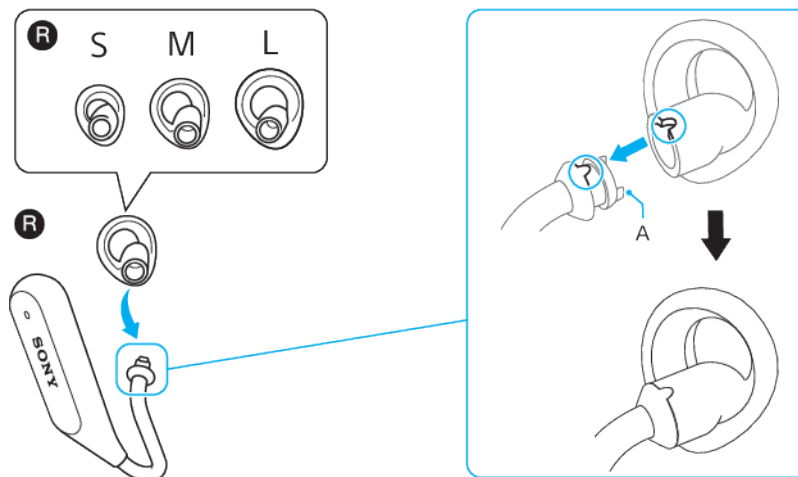

- 1 Choose the ring supporter size that fits stably and comfortably in your ear.
  - 2 To remove the ring supporter, hold the main unit tightly and push the ring supporter straight backward.
  - 3 To attach the ring supporter, align the convex part of the main unit with the concave part of the ring supporter.
  - 4 When attaching, cover the hook A with the rubber of the ring supporter as shown in the illustration. Make sure not to tear the ring supporter.
- ! When removing, do not forcibly pull or twist the ring supporter, as this can damage or tear it. When attaching, check the right/left markers on the ring supporters and main units to be sure they are matched correctly.

### **Caring for your Xperia Ear Duo and your skin**

To help avoid skin irritation, clean your Xperia Ear Duo regularly. Remove and rub the ring supporter with a dry cloth.

- ⚠ If you start to experience skin irritation or an allergic reaction, stop wearing your Xperia Ear Duo. Contact your physician if symptoms persist.

# Using your Xperia Ear Duo

## Using the touchpad

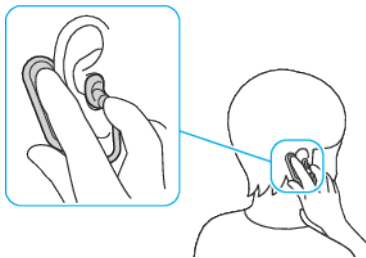

When wearing your Xperia Ear Duo, use the touchpad for various actions.

- ! Steady the main unit with your fingers if it moves during use.

### Tapping

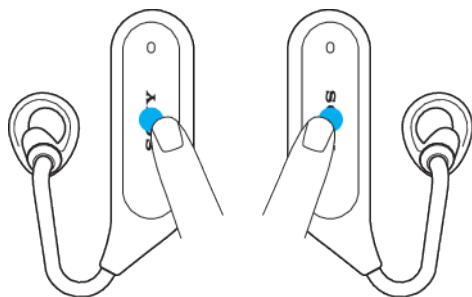

- Tap the touchpad with your finger.
- 💡 If the main unit doesn't respond when you double-tap or triple-tap, try tapping at a different speed.

### Touching and holding

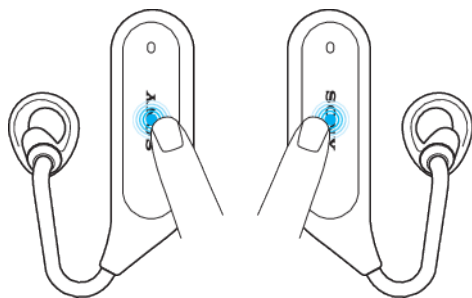

- Touch and hold the touchpad with your finger.

### Sliding

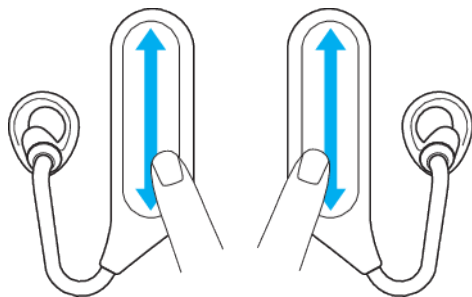

- Slide your finger firmly up or down on the touchpad, then release it.

## Using head gestures

Use supported head gestures to communicate with your Xperia Ear Duo.

- ! In order to use head gestures, you must enable this feature with the host app. Some features may not be available in all regions.

### To enable or disable head gestures

- 1 Open the **Xperia Ear Duo** app on the paired device.
- 2 Find and tap **Device Settings > Head gesture**.
- 3 Tap the checkboxes to enable or disable each function.

### To answer or decline a call

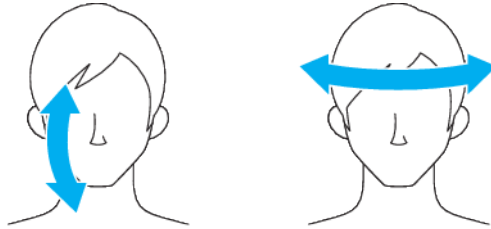

- Nod your head to answer a call.
- Shake your head to decline a call.

### To skip to the previous or the next music track



- Turn your head to the left then back to skip to the previous music track.
- Turn your head to the right then back to skip to the next music track.

### To respond to the Assistant

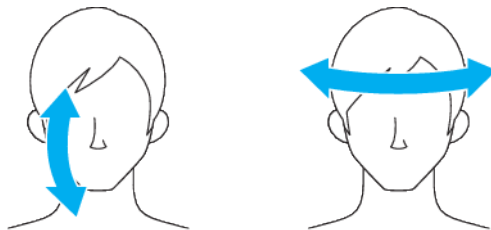

- Nod your head to give positive feedback.
- Shake your head to give negative feedback.
- ! This function is not available on iOS devices.

### To cancel notification and start-up message readouts

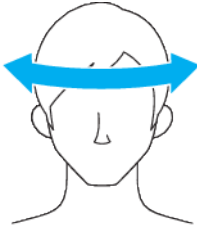

- Shake your head.
- ! This function is not available on iOS devices.

## Calling

Use your Xperia Ear Duo to make, answer and reject calls. For these functions to work, you must use an Android or iOS device that supports the relevant functions, for example, call handling and messaging. You must also have the host app installed on the Android or iOS device.

### To answer an incoming call

- When wearing your Xperia Ear Duo, tap the touchpad of either main unit to answer a call.
- You can also use head gestures to answer a call.

### To read out the caller name of an incoming call

- When using the host app, tap Assistant then tap the Caller name read-out switch to enable this function.
- 💡 For iOS devices, you can enable this function in the phone's settings menu.

### To end a call

- When wearing your Xperia Ear Duo, touch and hold the touchpad of either main unit to end a call.

### To reject an incoming call

- When wearing your Xperia Ear Duo, touch and hold the touchpad of either main unit to reject a call.
- You can also use head gestures to reject a call.

### To mute the microphone during a call

- During a call, double-tap the touchpad of the main unit (R) or (L).

### To unmute the microphone during a call

- During a call, double-tap the touchpad of the main unit (R) or (L) again.

### To answer a call waiting

- During a call, tap the touchpad of the main unit (R) or (L). The ongoing call is put on hold.

### To switch between multiple calls

- Triple-tap the touchpad of the main unit (R) or (L).

## Listening to music

Control music playback by tapping the touchpad of the main unit (L), or ask the Assistant while music is playing. You can listen to music with both main units or just the main unit (R) in your ear.

### To play or pause a music track

- Tap the touchpad of the main unit (L).

### To skip to the next music track

- Double-tap the touchpad of the main unit (L).

### To skip to the previous music track or return to the beginning of the current track

- Triple-tap the touchpad of the main unit (L).
-  To use head gestures to skip music tracks, see *To skip to the previous or the next music track* on page 14.

## Adjusting the volume

### To adjust the volume

- Slide up or down on the touchpad of either main unit to adjust the volume.
-  When using the Adaptive volume control function, the volume is adjusted automatically depending on the surrounding environment.

## Using voice control

### To use voice control

- Touch and hold the touchpad of the main unit (R) to activate voice command.

## Anytime Talk

-  This application is the beta version. Anytime Talk is a service that requires a stable internet connection. Depending on the network status, you may not be able to chat using Anytime Talk. (4G network is recommended.)

Anytime Talk is an app that lets you use your Xperia Ear Duo for instant voice chat with up to four other users in a chat group. You can also use head gestures to reply with pre-recorded sounds. Hear an Online/Offline sound when participants join or leave the chat group.

Since Anytime Talk works through the internet, there is no limit to the communication range.

All participants in the chat group must use an Xperia Ear or Xperia Ear Duo unit, and complete the Anytime Talk setup using the host application on a paired Android device. This function is not available on iOS.



## Using Anytime Talk

### To create a new chat group for the first time

- 1 Open the **Xperia Ear Duo** app on the paired device.
  - 2 Find and tap **Anytime Talk**.
  - 3 Follow the on-screen instructions to sign up with your Google account.
  - 4 Tap **CREATE GROUP** to create a group as a host.
  - 5 Ask all guests to scan the QR code shown on your device, or tap **Invite** to send an invitation to the guests via email or social media. You can invite up to four guests.
  - 6 After all guests have scanned the QR code, or accepted the invitation via email or social media, tap **Next**.
  - 7 Follow the on-screen instructions to record an **Online/Offline sound** and tap **FINISH** to complete setup.
- ! Ensure that all participants have joined before tapping Next.

### To join a chat group for the first time

- 1 Open the **Xperia Ear Duo** app on the paired device.
- 2 Find and tap **Anytime Talk**.
- 3 Follow the on-screen instructions to sign up with your Google account.
- 4 Tap **JOIN GROUP** to join a group as a guest.
- 5 Scan the QR code shown on the host's device, or accept the invitation via email or social media, then tap **Next**.
- 6 Follow the on-screen instructions to record an **Online/Offline sound** and tap **FINISH** to complete the setup.

### To add a guest to a chat group

- 1 When using the host app, find and tap **Anytime Talk**.
  - 2 Tap **Add guests**.
- ! Only the host can add or remove guests from the group.

### To remove a guest from a chat group

- 1 When using the host app, find and tap **Anytime Talk**.
  - 2 Tap **⋮** > **Delete chat group member(s)**.
  - 3 Select the guest you want to remove.
- ! Only the host can add or remove guests from the group.

### To create or join another chat group

- 1 When using the host app, find and tap **Anytime Talk**.
  - 2 Select **Create new chat group** or **Join new chat group**.
  - 3 Follow the on-screen instructions.
- ! You can only be in one chat group at a time.

### To chat with Anytime Talk

- 1 To enter a chat group, remove the Xperia Ear Duo from the charging case. Other participants will hear your online sound.
- 2 Touch and hold the touchpad of the main unit (L) to talk when you hear the online sound of another participant.
- 3 To leave the chat group, place the Xperia Ear Duo in the charging case. Your offline sound lets other participants know that you left the group.

### To record a gesture sound

- 1 When using the host app, find and tap **Anytime Talk**.
- 2 Tap **Head gesture sound**.
- 3 Tap **Custom sound (nodding)** or **Custom sound (head shake)**.
- 4 Follow the on-screen instructions.

# Settings

## Changing the key behaviour

You can change the touchpad settings. Use the host app to customise the key behaviour for the main units.

### To change the key behaviour

- 1 Open the **Xperia Ear Duo** app.
- 2 Find and tap **Device settings > Touchpad settings**.
- 3 Tap **Right** or **Left**.
- 4 Tap , then select an item.

! This function is not available on iOS devices.

## Setting the sound

Adaptive volume control adjusts the volume of your Xperia Ear Duo according to the sounds of your environment. The Clear Phase™ function lets you enjoy more natural and clear sound quality. The Dynamic normaliser lets you hear the sound more clearly in a noisy background. You can also select whether to prioritise sound quality or playback duration, under Sound quality.

You can change the sound settings in the Device Settings menu of the host app.

- 💡 The Prioritise playback duration option consumes less battery and allows for longer playback (SBC). The Prioritise sound quality option enhances sound quality, but shortens the playback duration since it consumes more battery (AAC).

## Setting the Assistant

You can specify what information you would like the Assistant to read out to you, and when.

- ! The Assistant only supports a limited number of languages. Some features may not be available depending on the region. For iOS devices, only voice notifications are supported.

## Setting up Daily Assist

You can personalise the information the Assistant provides you with. The information is customised based on your location.

### To set up Daily Assist

- 1 Open the **Xperia Ear Duo** app.
- 2 Tap **Assistant > Daily Assist**.
- 3 Select the readout timing and the information you want to receive. You can select to have information read out when you place the main unit in your ear, or based on your location, action or the time.
- 4 Select **When you put on the device** and **Based on your location** to customise according to your settings.

! You can cancel start-up message readouts by tapping the touchpad or using head gestures. The Assistant may not read out all messages and notifications, depending on when they were received.

- 💡 Registering your home address, company address and birthday lets you receive information more relevant to you.

## Managing notifications

You can select the applications and services you want to receive voice notifications for.

### To manage voice notifications

- 1 Open the **Xperia Ear Duo** app.
  - 2 Tap **Assistant > Voice notifications**.
  - 3 Select the applications you want to receive voice notifications for.
  - 4 Tap the switch to disable voice notifications.
- 💡 For Android devices, you can filter email readouts by sender or subject using the Email filter settings.

### To check the dialogue history

- When using the host app, find and tap  to check the dialogue history.

## Changing the voice interaction language

You can interact with the Assistant using one of the supported languages.

### To change the voice interaction language

- 1 Open the **Xperia Ear Duo** app.
- 2 Tap **Assistant > Voice interaction language**.
- 3 Select an option.
- 4 If the download message of voice data is displayed, follow the on-screen instructions to download the data.
- 5 Tap **OK**.

## Resetting the Xperia Ear Duo

Restart your Xperia Ear Duo if it behaves unexpectedly. If restarting does not solve the issue, you can perform a factory data reset.

- ! Make sure the main unit has enough battery by placing it in the charging case. Wait for the LED indicator to turn orange or green. Then, remove the main unit from the charging case before performing a reset.

### To restart your Xperia Ear Duo

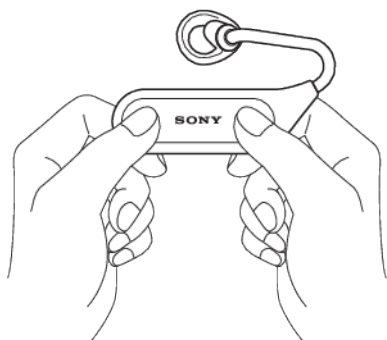

- 1 Remove the main unit (R) from the charging case. When the main unit turns on, the LED indicator flashes twice in white.
- 2 Using both thumbs, touch and hold the touchpad of the main unit (R) for 10 seconds. Make sure to place your thumbs on either side of the Sony logo.
- 3 The LED indicator on the main unit flashes twice in white. The main unit restarts and makes a start-up sound.
- 4 Repeat the procedure with the main unit (L).

## To perform a factory data reset

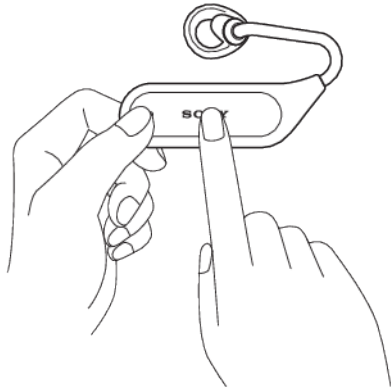

- 1 Remove the main unit (R) from the charging case. The LED indicator of the main unit flashes twice in white when it turns on.
  - 2 Quickly tap the touchpad three times, touching and holding firmly on the third tap.
  - 3 Continue touching and holding the touchpad until the LED indicator flashes four times in green. This indicates that the factory data reset is complete.
  - 4 When the main unit turns on automatically, the LED indicator flashes twice in white and it makes a start-up sound. It then flashes quickly in blue to indicate that the main unit is ready to be paired.
- ! Resetting your Xperia Ear Duo deletes all information about paired devices and reverts various settings to default.

# Legal information

## General

Prior to use, please read the *Important information* leaflet separately provided.

This User guide is published by Sony Mobile Communications Inc. or its local affiliated company, without any warranty. Improvements and changes to this User guide necessitated by typographical errors, inaccuracies of current information, or improvements to programs and/or equipment, may be made by Sony Mobile Communications Inc. at any time and without notice. Such changes will, however, be incorporated into new editions of this User guide.

Some functions described in this User guide may not be available for all regions.

All rights reserved.

©2018 Sony Mobile Communications Inc.

4-12-3 Higashi-Shinagawa, Shinagawa-ku, Tokyo, 140-0002 Japan

Sony Belgium, bijkantoor van Sony Europe Limited, Da Vincilaan 7-D1, 1935 Zaventem, Belgium

Sony is the trademark or registered trademark of Sony Corporation.

All product and company names mentioned herein are the trademarks or registered trademarks of their respective owners. Any rights not expressly granted herein are reserved. All other trademarks are property of their respective owners.

Visit [www.sonymobile.com](http://www.sonymobile.com) for more information.

All illustrations are for illustration only and may not accurately depict the actual accessory.

## Declaration of Conformity for XEA20



Hereby, Sony Mobile declares that the equipment type **RD-0222** is in compliance with Directive: **2014/53/EU**. The full text of the EU declaration of conformity is available at the following internet address: <http://www.compliance.sony.de/>

С настоящото Sony Mobile декларира, че радиосъоръжение тип **RD-0222** е в съответствие с Директива; **2014/53/ЕС**. Цялостният текст на ЕС декларацията за съответствие може да се намери на следния интернет адрес: <http://www.compliance.sony.de/>

Sony Mobile ovime izjavljuje da je radijska oprema tipa **RD-0222** u skladu s Direktivom; **2014/53/EU**. Cjeloviti tekst EU izjave o sukladnosti dostupan je na sljedećoj internetskoj adresi: <http://www.compliance.sony.de/>

Sony Mobile tímto prohlašuje, že radiové zařizení typ **RD-0222** je v souladu se směrnicí; **2014/53/EU**. Úplné znění EU prohlášení o shodě je k dispozici na této internetové adrese: <http://www.compliance.sony.de/>

Hermed erklarer Sony Mobile, at radioudstyrstypen **RD-0222** er i overensstemmelse med direktiv; **2014/53/EU**. EU-overensstemmelseserklaringens fulde tekst kan findes på følgende internetadresse: <http://www.compliance.sony.de/>

Hierbij verklaart Sony Mobile dat het type radioapparatuur **RD-0222** conform is met Richtlijn; **2014/53/EU**. De volledige tekst van de EU-conformiteitsverklaring kan worden geraadpleegd op het volgende internetadres: <http://www.compliance.sony.de/>

Käesolevaga deklareerib Sony Mobile, et käesolev raadioseadme tüüp **RD-0222** vastab direktiivi; **2014/53/EL** nouetele. ELi vastavusdeklaratsiooni täielik tekst on kättesaadav järgmisel internetiaadressil: <http://www.compliance.sony.de/>

Sony Mobile vakuuttaa, että radiolaitetyypin **RD-0222** on direktiivin; **2014/53/EU** mukainen. EU-vaatimustenmukaisuusvakuutuksen täysimittainen teksti on saatavilla seuraavassa internetosoitteessa: <http://www.compliance.sony.de/>

Le soussigné, Sony Mobile, déclare que l'équipement radioélectrique du type **RD-0222** est conforme à la directive; **2014/53/UE**. Le texte complet de la déclaration UE de conformité est disponible à l'adresse internet suivante: <http://www.compliance.sony.de/>

Hiermit erklärt Sony Mobile, dass der Funkanlagentyp **RD-0222** der Richtlinie; **2014/53/EU** entspricht. Der vollständige Text der EU-Konformitätserklärung ist unter der folgenden Internetadresse verfügbar: <http://www.compliance.sony.de/>

Με την παρούσα η Sony Mobile, δηλώνει ότι ο ραδιοεξοπλισμός **RD-0222** πληροί τους όρους της οδηγίας; **2014/53/ΕΕ**. Το πλήρες κείμενο της δήλωσης συμμόρφωσης ΕΕ διατίθεται στην ακόλουθη ιστοσελίδα στο διαδίκτυο: <http://www.compliance.sony.de/>

Sony Mobile igazolja, hogy a **RD-0222** típusú rádióberendezés megfelel a; **2014/53/EU** irányelvnek. Az EU-megfelelőségi nyilatkozat teljes szövege elérhető a következő internetes címen: <http://www.compliance.sony.de/>

Il fabbricante, Sony Mobile, dichiara che il tipo di apparecchiatura radio **RD-0222** e conforme alla direttiva; **2014/53/EU**. Il testo completo della dichiarazione di conformità UE e disponibile al seguente indirizzo Internet: <http://www.compliance.sony.de/>

Ar šo Sony Mobile deklarē, ka radioiekārta **RD-0222** atbilst Direktīvai; **2014/53/ES**. Pilns ES atbilstības deklarācijas teksts ir pieejams šādā interneta vietnē: <http://www.compliance.sony.de/>

Mes, Sony Mobile, patvirtiname, kad radijo įrenginių tipas **RD-0222** atitinka Direktyvą; **2014/53/ES**. Visas ES atitikties deklaracijos tekstas prieinamas šiuo interneto adresu: <http://www.compliance.sony.de/>

Il-Kumpanija Sony Mobile tiddikjara li t-tagħmir tar-radju tat tip **RD-0222** huwa konformi mad-Direttiva; **2014/53/EU**. It-test sħiħ tad-dikjarazzjoni ta' konformita tal-UE huwa disponibbli f'dan l-indirizz tal-Internet li ġej: <http://www.compliance.sony.de/>

Herved erklarer Sony Mobile at radioutstyr typen **RD-0222** er i samsvar med direktiv; **2014/53/EU**. EU-erklaring fulltekst finner du pa Internett under: <http://www.compliance.sony.de/>

Sony Mobile niniejszym oświadcza, że typ urządzenia radiowego **RD-0222** jest zgodny z dyrektywą; **2014/53/UE**. Pełny tekst deklaracji zgodności UE jest dostępny pod następującym adresem internetowym: <http://www.compliance.sony.de/>

O(a) abaixo assinado(a) Sony Mobile declara que o presente tipo de equipamento de rádio **RD-0222** está em conformidade com a Diretiva; **2014/53/UE**. O texto integral da declaração de conformidade está disponível no seguinte endereço de Internet: <http://www.compliance.sony.de/>

Prin prezenta, Sony Mobile declară că tipul de echipament radio **RD-0222** este în conformitate cu Directiva; **2014/53/UE**. Textul integral al declarației UE de conformitate este disponibil la următoarea adresă internet: <http://www.compliance.sony.de/>

Sony Mobile potrjuje, da je tip radijske opreme **RD-0222** skladen z Direktivo; **2014/53/EU**. Celotno besedilo izjave EU o skladnosti je na voljo na naslednjem spletnem naslovu: <http://www.compliance.sony.de/>

Sony Mobile týmto vyhlasuje, že rádiové zariadenie typu **RD-0222** je v súlade so smernicou; **2014/53/EU**. Úplné EÚ vyhlásenie o zhode je k dispozícii na tejto internetovej adrese: <http://www.compliance.sony.de/>

Por la presente, Sony Mobile declara que el tipo de equipo radioeléctrico **RD-0222** es conforme con la Directiva; **2014/53/UE**. El texto completo de la declaración UE de conformidad está disponible en la dirección Internet siguiente: <http://www.compliance.sony.de/>

Härmed försäkrar Sony Mobile att denna typ av radioutrustning **RD-0222** överensstämmer med direktiv; **2014/53/EU**. Den fullständiga texten till EU-försäkran om överensstämmelse finns på följande webbadress: <http://www.compliance.sony.de/>

Bu belgeyle, Sony Mobile Communications Inc., **RD-0222** tipi telsiz cihazının **2014/53/EU** sayılı Direktife uygun olduğunu beyan etmektedir. AB Uygunluk beyanının tüm metnine şu internet adresinden ulaşılabilir: <http://www.compliance.sony.de/>

## FCC Statement

This device complies with Part 15 of the FCC rules. Operation is subject to the following two conditions: (1) This device may not cause harmful interference, and (2) This device must accept any interference received, including interference that may cause undesired operation.

Any change or modification not expressly approved by Sony may void the user's authority to operate the equipment.

This equipment has been tested and found to comply with the limits for a Class B digital device, pursuant to Part 15 of the FCC Rules. These limits are designed to provide reasonable protection against harmful interference in a residential installation. This equipment generates, uses and can radiate radio frequency energy and, if not installed and used in accordance with the instructions, may cause harmful interference to radio communications. However, there is no guarantee that interference will not occur in a particular installation.

If this equipment does cause harmful interference to radio or television reception, which can be determined by turning the equipment off and on, the user is encouraged to try to correct the interference by one or more of the following measures:

- Reorient or relocate the receiving antenna.
- Increase the separation between the equipment and receiver.
- Connect the equipment into an outlet on a circuit different from that to which the receiver is connected.
- Consult the dealer or an experienced radio/TV technician for help.

## AVISO IMPORTANTE PARA MÉXICO

La operación de este equipo está sujeta a las siguientes dos condiciones: (1) es posible que este equipo o dispositivo no cause interferencia perjudicial y (2) este equipo o dispositivo debe aceptar cualquier interferencia, incluyendo la que pueda causar su operación no deseada.

Para consultar la información relacionada al número del certificado, refiérase a la etiqueta del empaque y/o del producto.

Alimentación: 3,8 Vcc

## **Industry Canada Statement**

This device complies with Industry Canada's licence-exempt RSSs. Operation is subject to the following two conditions: (1) This device may not cause interference; and (2) This device must accept any interference, including interference that may cause undesired operation of the device.

## **Avis d'industrie Canada**

Le présent appareil est conforme aux CNR d'Industrie Canada applicables aux appareils radio exempts de licence. L'exploitation est autorisée aux deux conditions suivantes: (1) l'appareil ne doit pas produire de brouillage; (2) l'utilisateur de l'appareil doit accepter tout brouillage radioélectrique subi, même si le brouillage est susceptible d'en compromettre le fonctionnement.