

Compact Disc Player

Operating Instructions



CDP-CE105

WARNING

To prevent fire or shock hazard, do not expose the unit to rain or moisture.

To avoid electrical shock, do not open the cabinet. Refer servicing to qualified personnel only.

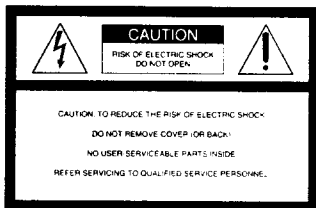

This symbol is intended to alert the user to the presence of uninsulated "dangerous voltage" within the product's enclosure that may be of sufficient magnitude to constitute a risk of electric shock to persons.



This symbol is intended to alert the user to the presence of important operating and maintenance (servicing) instructions in the literature accompanying the appliance.

INFORMATION

This equipment has been tested and found to comply with the limits for a Class B digital device, pursuant to Part 15 of the FCC Rules. These limits are designed to provide reasonable protection against harmful interference in a residential installation. This equipment generates, uses, and can radiate radio frequency energy and, if not installed and used in accordance with the instructions, may cause harmful interference to radio communications. However, there is no guarantee that interference will not occur in a particular installation. If this equipment does cause harmful interference to radio or television reception, which can be determined by turning the equipment off and on, the user is encouraged to try to correct the interference by one or more of the following measures:

- Reorient or relocate the receiving antenna.
- Increase the separation between the equipment and receiver.
- Connect the equipment into an outlet on a circuit different from that to which the receiver is connected.
- Consult the dealer or an experienced radio/TV technician for help.

CAUTION

You are cautioned that any changes or modification not expressly approved in this manual could void your authority to operate this equipment.

Owner's Record

The model and serial numbers are located on the rear of the unit.

Record the serial number in the space provided below. Refer to them whenever you call upon your Sony dealer regarding this product.

Model No. CDP-CE105

Serial No. _____

For the customers in Australia

The following caution label is located inside the unit.

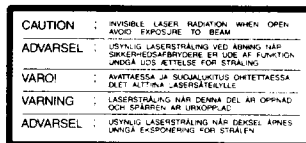

This appliance is classified as a CLASS 1 LASER product.

The CLASS 1 LASER PRODUCT MARKING is located on the rear exterior.

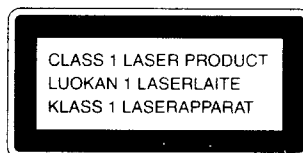

Precautions

On safety

- Caution — The use of optical instruments with this product will increase eye hazard.
- Should any solid object or liquid fall into the cabinet, unplug the player and have it checked by qualified personnel before operating it any further.

On power sources

- Before operating the player, check that the operating voltage of the player is identical with your local power supply. The operating voltage is indicated on the nameplate at the rear of the player.
- The player is not disconnected from the AC power source as long as it is connected to the wall outlet, even if the player itself has been turned off.
- If you are not going to use the player for a long time, be sure to disconnect the player from wall outlet. To disconnect the AC power cord, grasp the plug itself; never pull the cord.
- AC power cord must be changed only at the qualified service shop.

On placement

- Place the player in a location with adequate ventilation to prevent heat build-up in the player.
- Do not place the player on a soft surface such as a rug that might block the ventilation holes on the bottom.
- Do not place the player in a location near heat sources, or in a place subject to direct sunlight, excessive dust or mechanical shock.

On operation

- If the player is brought directly from a cold to a warm location, or is placed in a very damp room, moisture may condense on the lenses inside the player. Should this occur, the player may not operate properly. In this case, remove the disc and leave the player turned on for about an hour until the moisture evaporates.

On cleaning

- Clean the cabinet, panel and controls with a soft cloth slightly moistened with a mild detergent solution. Do not use any type of abrasive pad, scouring powder or solvent such as alcohol or benzene.

If you have any questions or problems concerning your player, please consult your nearest Sony dealer.

Welcome!

Thank you for purchasing the Sony Compact Disc Player. Before operating the unit, please read this manual thoroughly and retain it for future reference.

About This Manual

The instructions in this manual are for model CDP-CE105.

Convention

- The following icon is used in this manual:



Indicates hints and tips for making the task easier.

TABLE OF CONTENTS

Getting Started

Unpacking	4
Hooking Up the System	4

Playing a CD	6
--------------------	---

Playing CDs

Using the Display	8
Exchanging a Disc While Playing a Disc	8
Locating a Specific Disc	8
Locating a Specific Track or a Point in a Track	9
Playing Tracks Repeatedly (Repeat play)	9
Playing in Random Order (Shuffle Play)	9
Creating Your Own Program (Program Play)	10

Additional Information

Notes on CDs	11
Troubleshooting	12
Specifications	12

Index

Index	13
-------------	----

Unpacking

Check that you received the following item:

- Audio cord (1)

Hooking Up the System

Overview

This section describes how to hook up the CD player to an amplifier. Be sure to turn off the power of each component before making the connections.

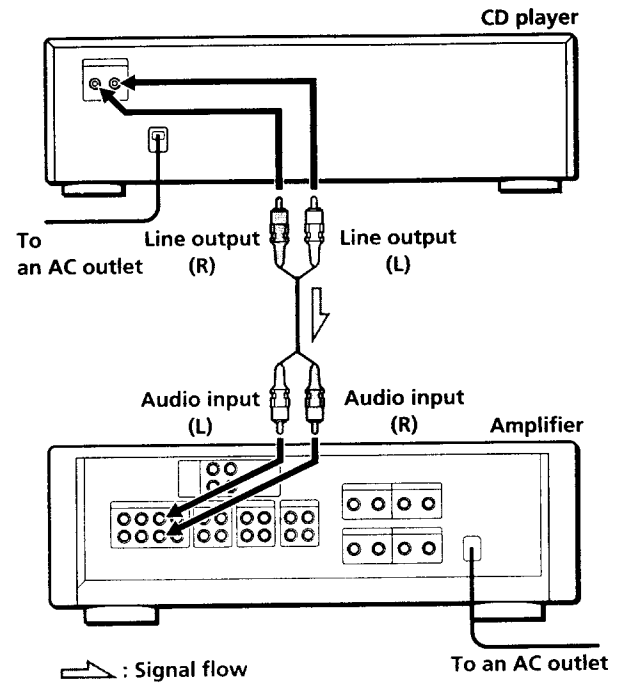

What cords will I need?

Audio cord (supplied) (1)



Hookups

When connecting the audio cord, be sure to match the color-coded cord to the appropriate jacks on the components: Red (right) to Red and White (left) to White. Be sure to make connections firmly to avoid hum and noise.

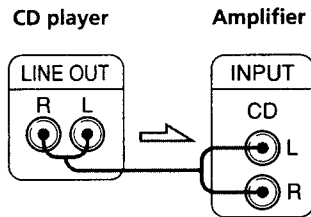

Connecting the AC power cord

Connect the AC power cord to a wall outlet.

Transporting the player

Before transporting the player, follow the procedure below to return the internal mechanisms back to their original position.

- 1 Remove all the discs from the disc tray.
- 2 Close the front cover and wait until "no dISC" appears in the display.
- 3 Press POWER to turn off the player.

Playing a CD

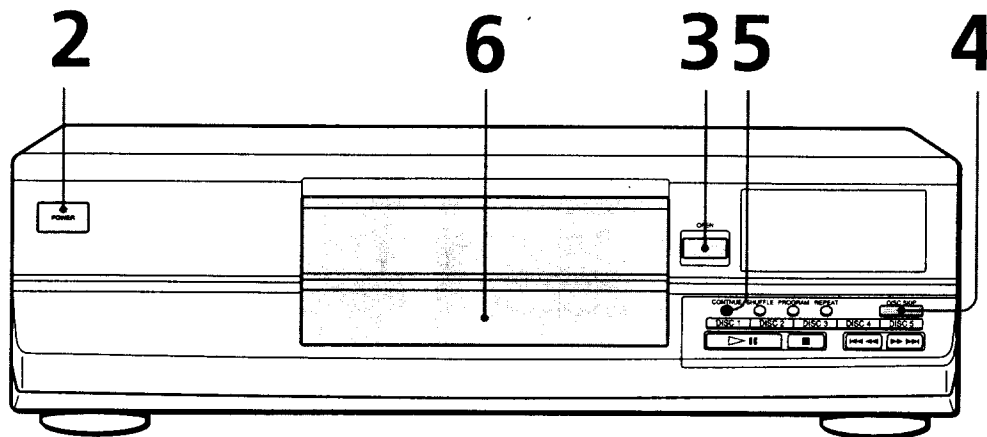

- See pages 4 – 5 for the hookup information.

- 1 Turn on the amplifier and select the CD player position so that you can listen to the sound from this player.
- 2 Press POWER to turn on the player.
- 3 Press OPEN, and place a disc on the disc tray at the loading position.

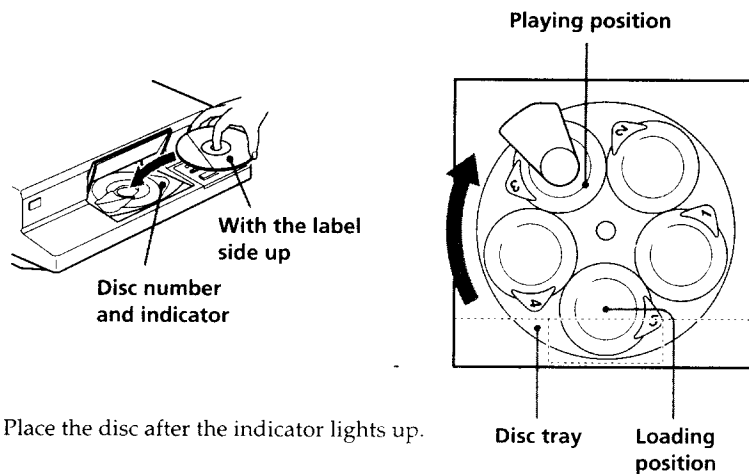

Place the disc after the indicator lights up.

 You can select the disc tray directly
Press one of the DISC 1-5 buttons. The disc tray rotates and you can place a disc in the empty disc compartments (loading position).

- 4 To place other discs, press DISC SKIP and place the discs in the order you want to play.
Each time you press the button, the disc tray rotates and you can place the discs in the empty disc compartments.
The player will play the disc at the loading position.

5 Press CONTINUE to select ALL DISCS or 1 DISC Continuous Play mode.

Each time you press CONTINUE, "ALL DISCS" or "1 DISC" appears in the display.

When you select	The player plays
ALL DISCS	All discs in the player consecutively in the order of disc number
1 DISC	Only one disc at the loading position

You can select the disc you want to play directly

Press one of the DISC 1-5 buttons with the front cover closed.

If there is no disc in the disc number, the disc tray rotates and plays the next disc.

Note

When the front cover is open, if the play of the current disc ends, the player stops playing.

If you want to play other discs, close the front cover and press the DISC 1-5 button.

6 Close the front cover and press ▷|| to play a disc.
Adjust the volume on the amplifier.

To stop playing

Press ■.

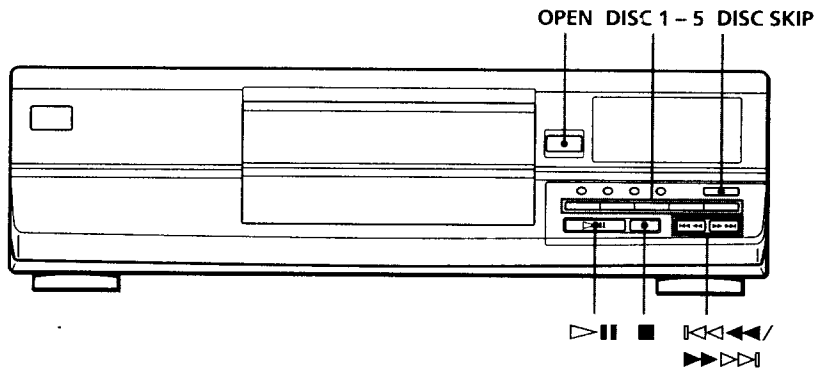

To	Press
Pause	▷
Resume playing after pause	▷
Go to the next track	▶▶▶▶
Go back to the preceding track	◀◀◀◀
Go to the next disc	DISC SKIP
Select a disc directly	DISC 1-5
Remove the CD	OPEN

Using the Display

You can check information about the disc using the display.

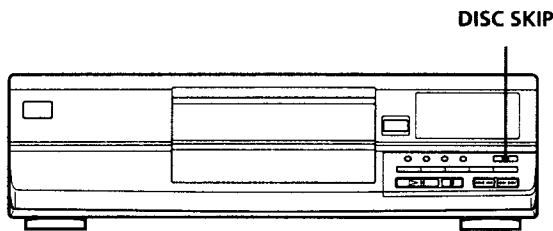

Checking the total number and playing time of the tracks

Close the front cover.

The display shows the current disc number, the total number of tracks and total playing time.

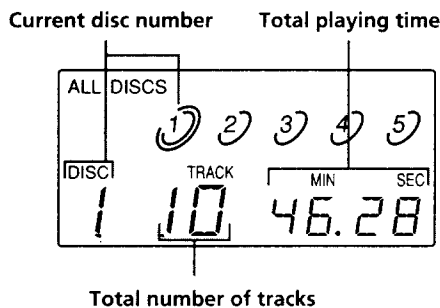

The information also appears when you press DISC SKIP in the stop mode.

Notes on the disc number indications

- The double-circle around a disc number indicates the disc is ready to be played.
- When a disc compartment is recognized as empty, the disc number disappears.

Display information while playing a disc

While playing a disc, the display shows the current disc number, track number, and playing time of the track.

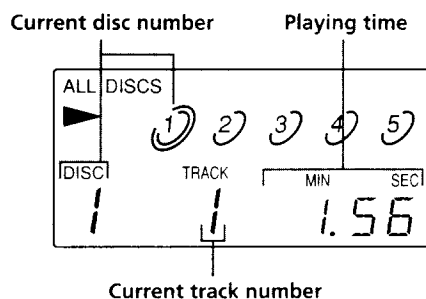

Exchanging a Disc While Playing a Disc

You can open the front cover while playing a disc so that you exchange a disc without interrupting the playing of the current disc.

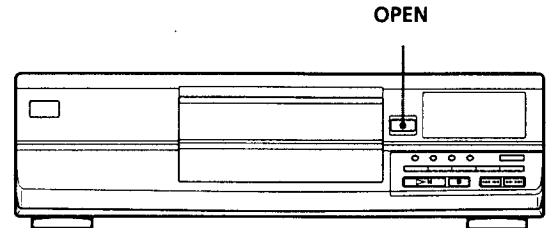

- 1 Press OPEN and exchange the disc at the loading position.
- 2 Close the front cover.
If you select the Continuous Play and ALL DISCS, exchanged disc number starts flashing.
The play of the current disc ends, and the disc whose disc number is flashing starts playing.

Note

While the disc number is flashing, if you press any buttons, the flashing stops and the player returns to the mode before the disc was exchanged.

Locating a Specific Disc

You can locate any disc before or while playing a disc.

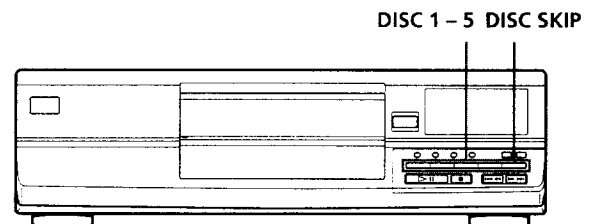

To locate	Press
The next disc	DISC SKIP while playing a disc
A specific disc directly	DISC 1 - 5

Locating a Specific Track or a Point in a Track

You can quickly locate any track while playing a disc using the **⏮⏮⏮/⏭⏭⏭** (AMS: Automatic Music Sensor) buttons. You can also locate a specific point in a track while playing a disc.

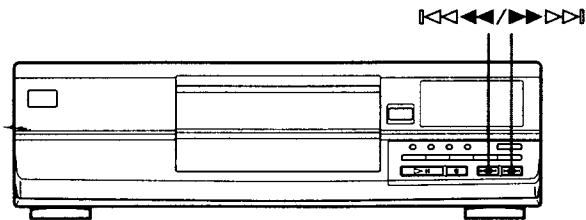

To locate	Press
The next or succeeding tracks	⏭⏭⏭ repeatedly until you find the track
The current or preceding tracks	⏮⏮⏮ repeatedly until you find the track
A point while monitoring the sound	⏭⏭⏭ (forward) or ⏮⏮⏮ (backward) and hold down until you find the point
A point quickly by observing the display during pause	⏭⏭⏭ (forward) or ⏮⏮⏮ (backward) and hold down until you find the point. You will not hear the sound during the operation.

Note

If "7 7" appears in the display, the disc has reached the end while you were pressing and holding **⏭⏭⏭**. Press **⏮⏮⏮** to go back.

Playing Tracks Repeatedly (Repeat Play)

You can play discs/tracks repeatedly in any play mode.

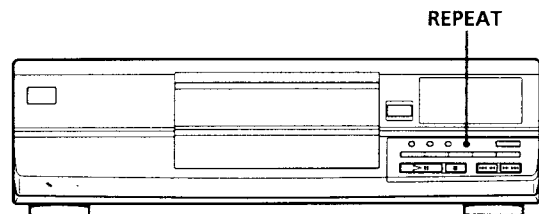

Press REPEAT while playing a disc. "REPEAT" appears in the display. The player repeats the discs/tracks as follows:

When the disc is played in	The player repeats
Continuous Play (ALL DISCS) (page 7)	All the tracks on all discs
Continuous Play (1 DISC) (page 7)	All the tracks on the current disc
Shuffle Play (ALL DISCS) (page 9)	All the tracks on all discs in random order
Shuffle Play (1 DISC) (page 9)	All the tracks on the current disc in random order
Program Play (page 10)	The same program

To cancel Repeat Play

Press REPEAT repeatedly until "REPEAT" disappears from the display.

Repeating the current track

You can repeat the current track.

While the track you want is being played, press REPEAT repeatedly until "REPEAT 1" appears in the display.

Playing in Random Order (Shuffle Play)

You can have the player "shuffle" tracks and play in random order. The player shuffles all the tracks on all discs or on the disc you've specified.

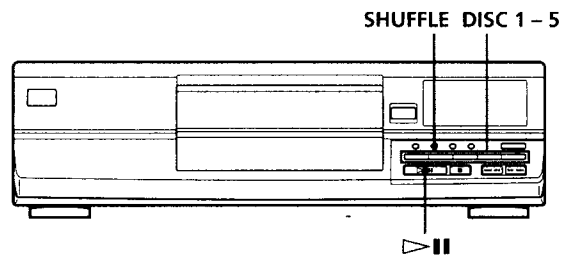

Shuffle Play on all discs

You can play all tracks on all discs in random order.

- 1 Press SHUFFLE repeatedly until "ALL DISCS" appears in the display.
- 2 Press **▶||** to start ALL DISCS Shuffle Play. The **[]** indication appears while the player is "shuffling" the tracks.

To cancel Shuffle Play

Press CONTINUE.

You can start Shuffle Play while playing
 Press SHUFFLE, and Shuffle Play starts from the current track.

You can specify discs during Shuffle Play (Select Shuffle Play)
 You can specify discs during ALL DISCS Shuffle Play mode, and the tracks on the specified discs are played in random order.
 Circles appear only around the specified disc numbers in the display. To cancel the selected discs, press DISC 1 – 5 again. The circles disappear.
 To return to ALL DISCS Shuffle Play, press SHUFFLE twice.

Shuffle Play on one disc

You can play all tracks on a specific disc in random order.

- 1 Press SHUFFLE repeatedly until "1 DISC" appears in the display.
- 2 Press DISC 1 – 5 to start 1 DISC Shuffle Play on the selected disc.
 The [] indication appears while the player is "shuffling" the tracks.

To cancel Shuffle Play
 Press CONTINUE.

You can start Shuffle Play while playing
 Press SHUFFLE, and Shuffle Play starts from the current track.

Creating Your Own Program (Program Play)

You can arrange the order of the tracks on the discs and create your own program. The program can contain up to 32 steps.

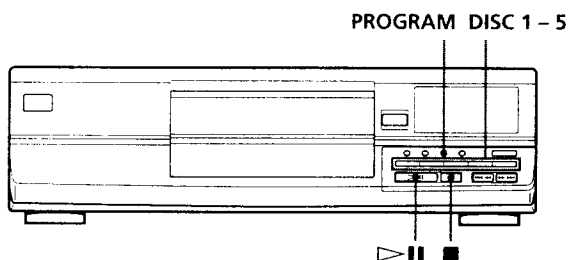

- 1 Press PROGRAM.
 "PROGRAM" appears in the display.
 If a program is already stored, the last step of the program appears in the display. When you want to erase the whole program, hold down ■ until "ALL CLr" appears for about 2 seconds in the display (see page 11).
- 2 Press DISC 1 – 5 to select the disc.

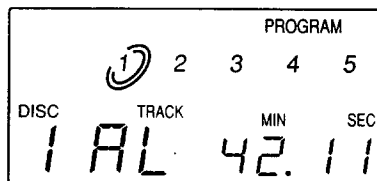

"AL" in the display stands for "all" tracks.
 When you want to program the whole disc as one step, skip Step 3 and 4 and go to Step 5.

- 3 Press ►►►► or ◀◀◀◀ to choose a track.
 The chosen track number and the total playing time flashes in the display.

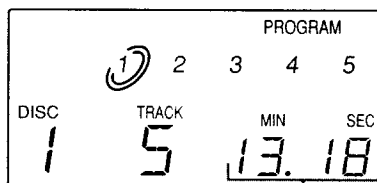

Total playing time

- 4 Press PROGRAM.
 "PROGRAM", track number and play order indications appear for a about 3 seconds in the display and then goes back to the Step 3 display.

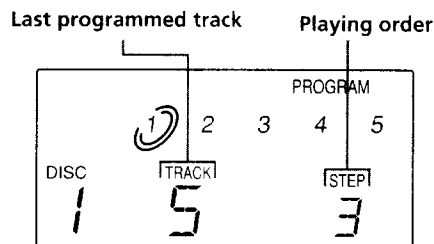

5 To program other discs or tracks, do the following:

To program	Repeat Step(s)
Other discs	2
Other tracks on the same disc	3 and 4
Other tracks on other discs	2, 3 and 4

6 Press ▷|| to start Program Play.

To cancel Program Play

Press CONTINUE.

💡 You can create your program while checking the disc labels

When the front cover is open, follow Steps 1 to 6 while pressing DISC SKIP to check the disc labels. Note that, if the programmed track number isn't found on the disc, that step is automatically erased.

💡 The program remains even after Program Play ends

When you press ▷||, you can play the same program again.

💡 The program remains until you erase it or turn off the player

If you exchange discs, the programmed disc and track numbers remain. So, the player plays only the existing disc and track numbers. However, the disc and track numbers that aren't found in the player or on the disc are deleted from the program, and the rest of the program is played in the programmed order.

Note

- The total playing time doesn't appear when:
 - You have programmed a track whose number exceeds 20.
 - The total playing time of the program exceeds 200 minutes.
 - Front cover is opened.

Changing the track order

You can change your program before you start playing.

To	Press
Erase the last step in the program	■. Each time you press the button, the last step will be cleared.
Change the whole program completely	■ until "ALL CLR" appears in the display. Create a new program following the programming procedure.

Notes on CDs

On handling CDs

- To keep the disc clean, handle the disc by its edge. Do not touch the surface.
- Do not stick paper or tape on the disc.

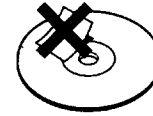

Not this way

- Do not expose the disc to direct sunlight or heat sources such as hot air ducts, nor leave it in a car parked in direct sunlight as there can be considerable rise in temperature inside the car.
- Do not use any commercially available stabilizer. If you do, the disc and the player may be damaged.
- After playing, store the disc in its case.

On cleaning

- Before playing, clean the disc with a cleaning cloth. Wipe the disc from the center out.



- Do not use solvents such as benzene, thinner, commercially available cleaners or anti-static spray intended for vinyl LPs.

Troubleshooting

If you experience any of the following difficulties while using the player, use this troubleshooting guide to help you remedy the problem. Should any problem persist, consult your nearest Sony dealer.

There's no sound.

- ➔ Check that the player is connected securely.
- ➔ Make sure you operate the amplifier correctly.

The CD does not play.

- ➔ There's no CD inside the player ("no DISC" appears). Insert a CD.
- ➔ Place the CD with the label side up on the disc tray correctly.
- ➔ Clean the CD (page 11).
- ➔ Moisture has condensed inside the player.
Remove the disc and leave the player turned on for about an hour (page 2).

The player functions incorrectly.

- ➔ The microcomputer chips may be operating incorrectly. Turn the power off, then turn it back on to reset the player.

Specifications

Compact disc player

Laser	Semiconductor laser ($\lambda = 780 \text{ nm}$) Emission duration: continuous
Laser output	Max 44.6 μW * * This output is the value measured at a distance of 200 mm from the objective lens surface on the Optical Pick-up block with 7 mm aperture.
Frequency response	2 Hz to 20 kHz $\pm 1.0 \text{ dB}$
Signal-to-noise ratio	More than 100dB
Dynamic range	More than 96dB
Harmonic distortion	Less than 0.01%
Channel separation	More than 86dB

Output

	Jack type	Maximum output level	Load impedance
LINE OUT	Phono jacks	2 V (at 50 kilohms)	Over 10 kilohms

General

Power requirements

Where purchased	Power requirements
USA	120 V AC, 60 Hz
Australia	240 V AC, 50/60 Hz

Power consumption	10 W
Dimensions (approx.) (w/h/d)	430 \times 135 \times 400 mm (17 \times 5 3/8 \times 15 3/4 in.) incl. projecting parts
Mass (approx.)	4.5 kg (9 lbs 15 oz)

Supplied accessories

Audio cord (2 phono plugs – 2 phono plugs) (1)

Design and specifications are subject to change without notice.

Index

A, B

- AMS 9
- Automatic Music Sensor. *See* AMS

C, D, E, F, G

- Connecting 4
- Continuous Play 7
- Exchanging a disc while playing a disc 8

H, I, J, K

- Handling CDs 11
- Hookups 4
- overview 4

L, M, N, O

- Locating
 - by monitoring 9
 - by observing the display 9
- using AMS 10

P, Q

- Playing
 - Continuous Play 7
 - Program Play 10
 - Repeat Play 9
 - Shuffle Play 9
- Program 10
- changing 11

R

- Repeating 9

S

- Searching. *See* Locating
- Select Shuffle Play 10
- Shuffle Play 9

T

- Total playing time 8
- Troubleshooting 12

U, V, W, X, Y, Z

- Unpacking 4

Names of controls

Buttons

- CONTINUE 7
- DISC 1-5 6
- DISC SKIP 6
- OPEN 6
- PROGRAM 10
- REPEAT 9
- SHUFFLE 9
- ▷|| 7
- 7
- ◀◀◀◀/▶▶▶▶ 7,9

Switch

- POWER 6

Others

- Disc compartment 6
- Disc tray 6
- Display 8
- Loading position 6
- Playing position 6

