

Trinitron[®] Color Computer Display

Operating Instructions

CPD-E210

Owner's Record

The model and serial numbers are located at the rear of the unit. Record these numbers in the spaces provided below. Refer to them whenever you call upon your dealer regarding this product.
Model No. _____ Serial No. _____

WARNING

To prevent fire or shock hazard, do not expose the unit to rain or moisture.

Dangerously high voltages are present inside the unit. Do not open the cabinet. Refer servicing to qualified personnel only.

FCC Notice

This equipment has been tested and found to comply with the limits for a Class B digital device, pursuant to Part 15 of the FCC Rules. These limits are designed to provide reasonable protection against harmful interference in a residential installation. This equipment generates, uses, and can radiate radio frequency energy and, if not installed and used in accordance with the instructions, may cause harmful interference to radio communications. However, there is no guarantee that interference will not occur in a particular installation. If this equipment does cause harmful interference to radio or television reception, which can be determined by turning the equipment off and on, the user is encouraged to try to correct the interference by one or more of the following measures:

- Reorient or relocate the receiving antenna.
- Increase the separation between the equipment and receiver.
- Connect the equipment into an outlet on a circuit different from that to which the receiver is connected.
- Consult the dealer or an experienced radio/TV technician for help.

You are cautioned that any changes or modifications not expressly approved in this manual could void your authority to operate this equipment.

INFORMATION

This product complies with Swedish National Council for Metrology (MPR) standards issued in December 1990 (MPR II) for very low frequency (VLF) and extremely low frequency (ELF).

NOTICE

This notice is applicable for USA/Canada only. If shipped to USA/Canada, install only a UL LISTED/CSA LABELLED power supply cord meeting the following specifications:

SPECIFICATIONS

Plug Type	Nema-Plug 5-15p
Cord	Type SVT or SJT, minimum 3 × 18 AWG
Length	Maximum 15 feet
Rating	Minimum 7 A, 125 V

NOTICE

Cette notice s'applique aux Etats-Unis et au Canada uniquement.

Si cet appareil est export* aux Etats-Unis ou au Canada, utiliser le cordon d'alimentation portant la mention UL LISTED/CSA LABELLED et remplissant les conditions suivantes:

SPECIFICATIONS

Type de fiche	Fiche Nema 5-15 broches
Cordon	Type SVT ou SJT, minimum 3 × 18 AWG
Longueur	Maximum 15 pieds
Tension	Minimum 7 A, 125 V

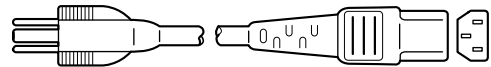

As an ENERGY STAR Partner, Sony Corporation has determined that this product meets the ENERGY STAR guidelines for energy efficiency.

If you have any questions about this product, you may call:

Sony Customer Information Center

1-800-222-SONY (7669)

or write to:

Sony Customer Information Center

1 Sony Drive, Mail Drop #T1-11, Park Ridge, NJ 07656

Declaration of Conformity

Trade Name: Sony
Model No.: CPD-E210
Responsible Party: Sony Electronics Inc.
Address: 1 Sony Drive, Park Ridge, NJ 07656 USA
Telephone No.: 201-930-6970

This device complies with Part 15 of the FCC Rules. Operation is subject to the following two conditions: (1) This device may not cause harmful interference, and (2) this device must accept any interference received, including interference that may cause undesired operation.

Table of Contents

Precautions	4
Identifying parts and controls	5
Setup	6
Step 1: Connect your monitor to your computer	6
Step 2: Connect the power cord	6
Step 3: Turn on the monitor and computer	7
Selecting the on-screen menu language (LANG)	7
Customizing Your Monitor	8
Navigating the menu	8
Adjusting the brightness and contrast	9
Adjusting the centering of the picture (CENTER)	9
Adjusting the size of the picture (SIZE)	9
Enlarging or reducing the picture (ZOOM)	10
Adjusting the shape of the picture (GEOM)	10
Adjusting the color of the picture (COLOR)	10
Adjusting the convergence (CONV)	10
Additional settings (OPTION)	11
Helpful hints and information (HELP)	12
Resetting the adjustments	12
Technical Features	13
Preset and user modes	13
Power saving function	13
Troubleshooting	13
If thin lines appear on your screen (damper wires)	13
On-screen messages	13
Trouble symptoms and remedies	14
Self-diagnosis function	Back cover
Specifications	Back cover

- Trinitron[®] and FD Trinitron[®] is a registered trademark of Sony Corporation.
- Macintosh is a trademark licensed to Apple Computer, Inc., registered in the U.S.A. and other countries.
- Windows[®] and MS-DOS are registered trademarks of Microsoft Corporation in the United States and other countries.
- IBM PC/AT and VGA are registered trademarks of IBM Corporation of the U.S.A.
- VESA and DDC[™] are trademarks of the Video Electronics Standard Association.
- ENERGY STAR is a U.S. registered mark.
- All other product names mentioned herein may be the trademarks or registered trademarks of their respective companies.
- Furthermore, “™” and “®” are not mentioned in each case in this manual.

Precautions

Warning on power connections

- Use the supplied power cord. If you use a different power cord, be sure that it is compatible with your local power supply.

For the customers in the U.S.A.

If you do not use the appropriate cord, this monitor will not conform to mandatory FCC standards.

Example of plug types

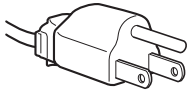

for 100 to 120 V AC

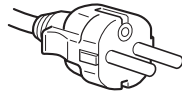

for 200 to 240 V AC

- Before disconnecting the power cord, wait at least 30 seconds after turning off the power to allow the static electricity on the screen's surface to discharge.
- After the power is turned on, the screen is demagnetized (degaussed) for about 5 seconds. This generates a strong magnetic field around the screen which may affect data stored on magnetic tapes and disks placed near the monitor. Be sure to keep magnetic recording equipment, tapes, and disks away from the monitor.

The equipment should be installed near an easily accessible outlet.

Installation

Do not install the monitor in the following places:

- on surfaces (rugs, blankets, etc.) or near materials (curtains, draperies, etc.) that may block the ventilation holes
- near heat sources such as radiators or air ducts, or in a place subject to direct sunlight
- in a place subject to severe temperature changes
- in a place subject to mechanical vibration or shock
- on an unstable surface
- near equipment which generates magnetism, such as a transformer or high voltage power lines
- near or on an electrically charged metal surface

Maintenance

- Clean the screen with a soft cloth. If you use a glass cleaning liquid, do not use any type of cleaner containing an anti-static solution or similar additive as this may scratch the screen's coating.
- Do not rub, touch, or tap the surface of the screen with sharp or abrasive items such as a ballpoint pen or screwdriver. This type of contact may result in a scratched picture tube.
- Clean the cabinet, panel and controls with a soft cloth lightly moistened with a mild detergent solution. Do not use any type of abrasive pad, scouring powder or solvent, such as alcohol or benzene.

Transportation

When you transport this monitor for repair or shipment, use the original carton and packing materials.

Use of the tilt-swivel

This monitor can be adjusted within the angles shown below. To find the center of the monitor's turning radius, align the center of the monitor's screen with the centering dots on the stand.

Hold the monitor at the bottom with both hands when you turn it horizontally or vertically. Be careful not to pinch your fingers at the back of the monitor when you tilt the monitor up vertically.

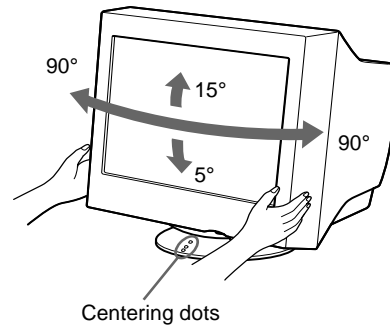

Identifying parts and controls

See the pages in parentheses for further details.

Front

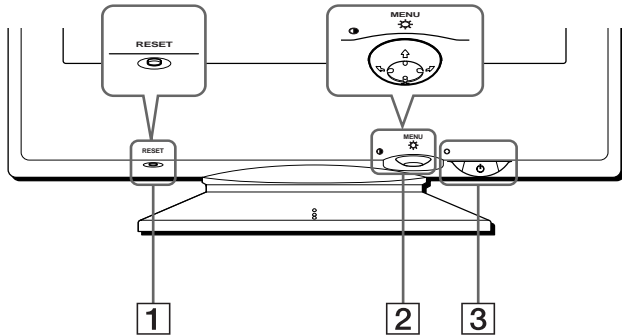

1 RESET button (page 12)

This button resets the adjustments to the factory settings.

2 Control button (page 9)

The control button is used to display the menu and make adjustments to the monitor, including brightness and contrast adjustments.

3  (power) switch and indicator (pages 7, 13 and back cover)

This button turns the monitor on and off. The power indicator lights up in green when the monitor is turned on, and either flashes in green and orange, or lights up in orange when the monitor is in power saving mode.

Rear

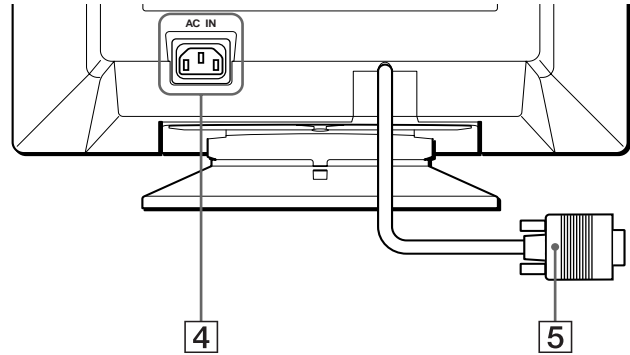

4 AC IN connector (page 6)

This connector provides AC power to the monitor.

5 Video input connector (HD15) (page 6)

This connector inputs RGB video signals (0.700 Vp-p, positive) and sync signals.

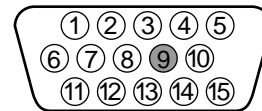

Pin No.	Signal
1	Red
2	Green (Sync on Green)
3	Blue
4	ID (Ground)
5	DDC Ground*
6	Red Ground
7	Green Ground
8	Blue Ground
9	–
10	Ground
11	ID (Ground)
12	Bi-Directional Data (SDA)*
13	H. Sync
14	V. Sync
15	Data Clock (SCL)*

* DDC (Display Data Channel) is a standard of VESA.

Setup

Before using your monitor, check that the following accessories are included in your carton:

- Power cord (1)
- Warranty card (1)
- Notes on cleaning the screen's surface (1)
- This instruction manual (1)
- Information sheet for Macintosh users (1)

Step 1: Connect your monitor to your computer

Turn off the monitor and computer before connecting.

Note

Do not touch the pins of the video cable connector as this might bend the pins.

■ Connecting to an IBM PC/AT or compatible computer

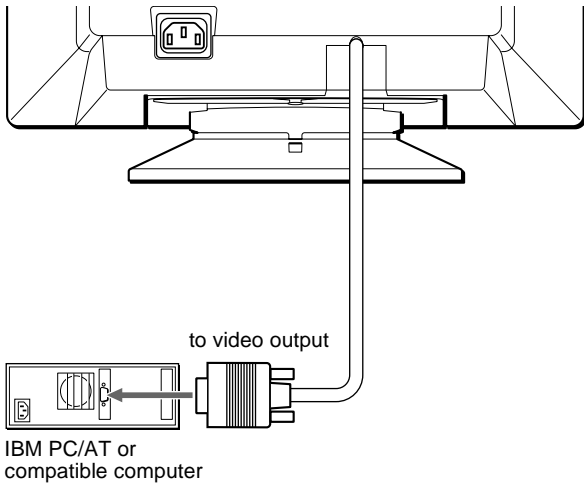

■ Connecting to a Macintosh or compatible computer

You will need a Macintosh adapter (not supplied).

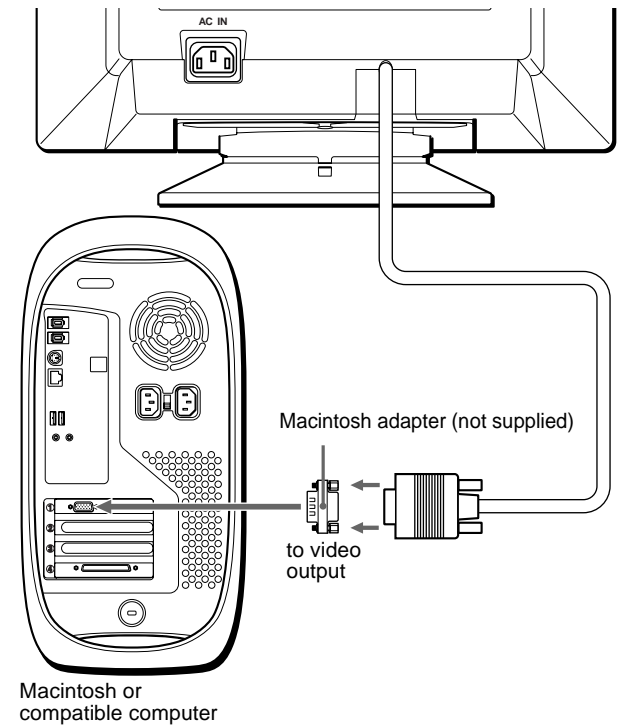

Step 2: Connect the power cord

With the monitor and computer switched off, first connect the power cord to the monitor, then connect it to a power outlet.

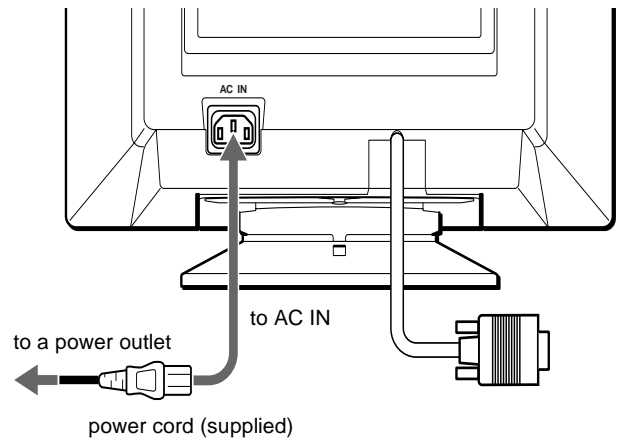

Step 3: Turn on the monitor and computer

First turn on the monitor, then turn on the computer.

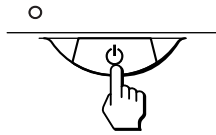

The installation of your monitor is complete.
If necessary, use the monitor's controls to adjust the picture.

If no picture appears on your screen

- Check that the monitor is correctly connected to the computer.
- If NO INPUT SIGNAL appears on the screen, confirm that the video signal cable is properly connected and all plugs are firmly seated in their sockets.
- If MONITOR IS IN POWER SAVE MODE appeared on the screen, try pressing any key on the computer keyboard.
- If you are replacing an old monitor with this model and OUT OF SCAN RANGE appears on the screen, reconnect the old monitor. Then adjust the computer's graphic board so that the horizontal frequency is between 30 – 85 kHz, and the vertical frequency is between 48 – 120 Hz.

For more information about the on-screen messages, see "Trouble symptoms and remedies" on page 14.

For customers using Windows NT4.0

Monitor setup in Windows NT4.0 is different from Windows 95/98 and does not involve the selection of monitor type. Refer to the Windows NT4.0 instruction manual for further details on adjusting the resolution, refresh rate, and number of colors.

Adjusting the monitor's resolution and color number

Adjust the monitor's resolution and color number by referring to your computer's instruction manual. The color number may vary according to your computer or video board. The color palette setting and the actual number of colors are as follows:

- High Color (16 bit) → 65,536 colors
- True Color (24 bit) → about 16.77 million colors

In true color mode (24 bit), speed may be slower.

Selecting the on-screen menu language (LANG)

English, French, German, Spanish, Italian, Dutch, Swedish, Russian and Japanese versions of the on-screen menus are available. The default setting is English.

1 Press the center of the control button.

See page 9 for more information on using the control button.

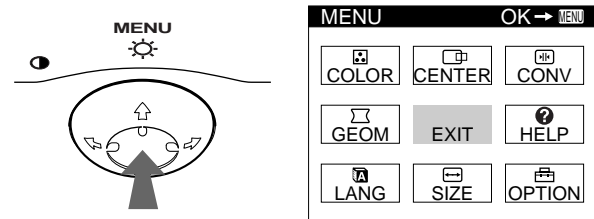

2 Move the control button to highlight LANG and press the center of the control button again.



3 Move the control button ↓/↑ to select a language.

- ENGLISH
- FRANÇAIS: French
- DEUTSCH: German
- ESPAÑOL: Spanish
- ITALIANO: Italian
- NEDERLANDS: Dutch
- SVENSKA: Swedish
- РУССКИЙ: Russian
- 日本語: Japanese

To close the menu

Press the center of the control button once to return to the main MENU, and twice to return to normal viewing. If no buttons are pressed, the menu closes automatically after about 30 seconds.

To reset to English

Press the RESET button while the LANGUAGE menu is displayed on the screen.

Customizing Your Monitor

You can make numerous adjustments to your monitor using the on-screen menu.

Navigating the menu

Press the center of the control button to display the main MENU on your screen. See page 9 for more information on using the control button.

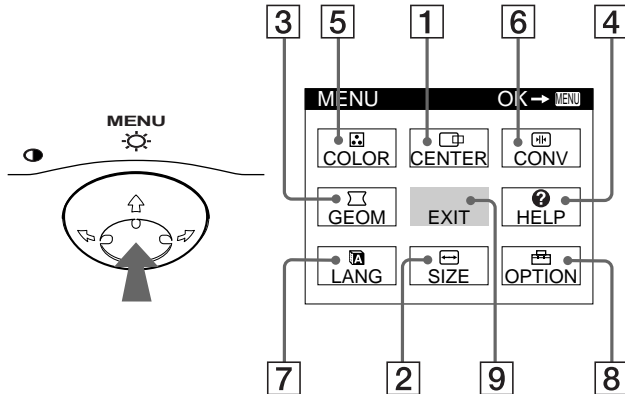

Use the control button to select one of the following menus.

1 CENTER (page 9)

Selects the CENTER menu to adjust the picture's centering, size or zoom.

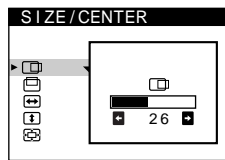

2 SIZE (page 9)

Selects the SIZE menu to adjust the picture's size, centering or zoom.

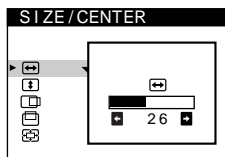

3 GEOM (page 10)

Select the GEOM menu to adjust the picture's rotation and shape.

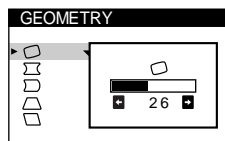

4 HELP (page 12)

Select the HELP menu to display helpful hints and information about this monitor.

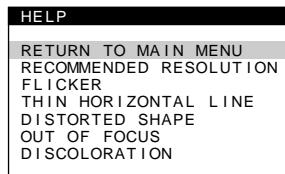

5 COLOR (page 10)

Select the COLOR menu to adjust the picture's color temperature. You can use this to match the monitor's colors to a printed picture's colors.

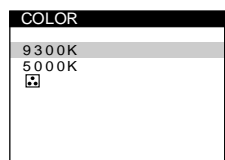

6 CONV (page 10)

Select the CONV menu to adjust the picture's horizontal and vertical convergence.

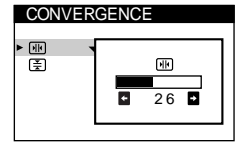

7 LANG (page 7)

Select LANG to choose the on-screen menu's language.



8 OPTION (page 11)

Select OPTION to adjust the monitor's options. The options include:

- degaussing the screen
- adjusting the moire cancellation level
- changing the on-screen menu position
- locking the controls

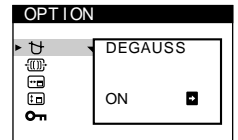

9 EXIT

Select EXIT to close the menu.

■ Displaying the current input signal

The horizontal and vertical frequencies of the current input signal are displayed in the main MENU. If the signal matches one of this monitor's factory preset modes, the resolution is also displayed.

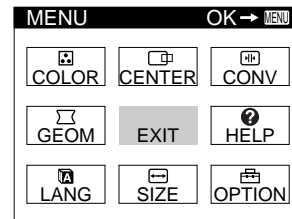

the resolution of the current input signal — 68.7kHz / 85Hz — the horizontal and vertical frequencies of the current input signal

1024x768

■ Using the control button

1 Display the main MENU.

Press the center of the control button to display the main MENU on your screen.

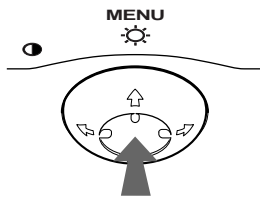

2 Select the menu you want to adjust.

Highlight the desired menu by moving the control button towards the rear to go up (↑), towards the front to go down (↓), and left (←) or right (→) to move sideways.

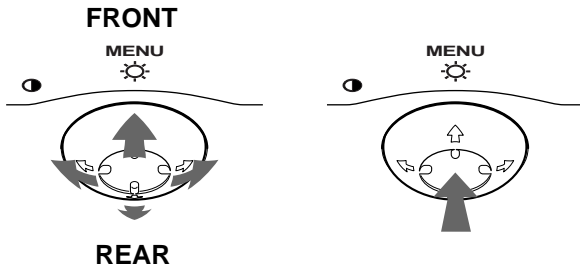

3 Adjust the menu.

Move the control button left (←) or right (→) to make the adjustment.

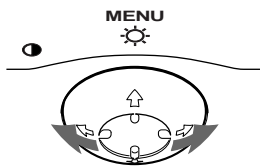

4 Close the menu.

Press the center of the control button once to return to the main MENU, and twice to return to normal viewing. If no buttons are pressed, the menu closes automatically after about 30 seconds.

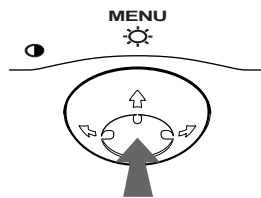

■ Resetting the adjustments

Press the RESET button. See page 12 for more information on resetting the adjustments.

RESET

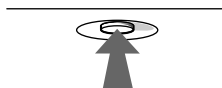

Adjusting the brightness and contrast

Brightness and contrast adjustments are made using a separate BRIGHTNESS/CONTRAST menu.

These settings are stored in memory for all input signals.

1 Move the control button in any direction.

The BRIGHTNESS/CONTRAST menu appears on the screen.



2 Move the control button ↓/↑ to adjust the brightness (☀), and ←/→ to adjust the contrast (⊖).

The menu automatically disappears after about 3 seconds.

Adjusting the centering of the picture (CENTER)

This setting is stored in memory for the current input signal.

1 Press the center of the control button.

The main MENU appears on the screen.

2 Move the control button to highlight CENTER and press the center of the control button again.

The SIZE/CENTER menu appears on the screen.

3 First move the control button ↓/↑ to select for horizontal adjustment, or for vertical adjustment. Then move the control button ←/→ to adjust the centering.

Adjusting the size of the picture (SIZE)

This setting is stored in memory for the current input signal.

1 Press the center of the control button.

The main MENU appears on the screen.



2 Move the control button to highlight SIZE and press the center of the control button again.

The SIZE/CENTER menu appears on the screen.

3 First move the control button ↓/↑ to select for horizontal adjustment, or for vertical adjustment. Then move the control button ←/→ to adjust the size.

Enlarging or reducing the picture (ZOOM)

This setting is stored in memory for the current input signal.

- 1 Press the center of the control button.**
The main MENU appears on the screen.
- 2 Move the control button to highlight  SIZE or CENTER and press the center of the control button again.**
The SIZE/CENTER menu appears on the screen.
- 3 Move the control button \downarrow/\uparrow to select  (zoom), and move \leftarrow/\rightarrow to enlarge or reduce the picture.**

Notes





- Adjustment stops when either the horizontal or vertical size reaches its maximum or minimum value.
- The horizontal adjustment value is not displayed in the menu.

Adjusting the shape of the picture (GEOM)

The GEOM settings allow you to adjust the rotation and shape of the picture.

The  (rotation) setting is stored in memory for all input signals. All other settings are stored in memory for the current input signal.



- 1 Press the center of the control button.**
The main MENU appears on the screen.
- 2 Move the control button to highlight  GEOM and press the center of the control button again.**
The GEOMETRY menu appears on the screen.
- 3 First move the control button \downarrow/\uparrow to select the desired adjustment item. Then move the control button \leftarrow/\rightarrow to make the adjustment.**

Select	To
	rotate the picture
	expand or contract the picture sides
	shift the picture sides to the left or right
	adjust the picture width at the top of the screen
	shift the picture to the left or right at the top of the screen

Adjusting the color of the picture (COLOR)

The COLOR settings allow you to adjust the picture's color temperature by changing the color level of the white color field. Colors appear reddish if the temperature is low, and bluish if the temperature is high. This adjustment is useful for matching the monitor's colors to a printed picture's colors.

This setting is stored in memory for all input signals.

- 1 Press the center of the control button.**
The main MENU appears on the screen.
- 2 Move the control button to highlight  COLOR and press the center of the control button again.**
The COLOR menu appears on the screen.
- 3 Move the control button \downarrow/\uparrow to select a color temperature.**
The preset color temperatures are 5000K and 9300K. Since the default setting is 9300K, the whites will change from a bluish hue to a reddish hue as the temperature is lowered to 5000K.
- 4 If necessary, fine tune the color temperature.**
You can select your own color temperature between 9300K and 5000K.
First move the control button \downarrow/\uparrow to select . Then move the control button \leftarrow/\rightarrow to adjust the color temperature.

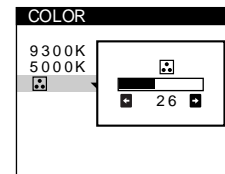



Adjusting the convergence (CONV)

The CONV settings allow you to adjust the quality of the picture by controlling the convergence. The convergence refers to the alignment of the red, green, and blue color signals.

If you see red or blue shadows around letters or lines, adjust the convergence.

These settings are stored in memory for all input signals.

- 1 Press the center of the control button.**
The main MENU appears on the screen.
- 2 Move the control button to highlight  CONV and press the center of the control button again.**
The CONVERGENCE menu appears on the screen.
- 3 First move the control button \downarrow/\uparrow to select  for horizontal adjustment, or  for vertical adjustment. Then move the control button \leftarrow/\rightarrow to adjust the convergence.**

Additional settings (OPTION)

You can manually degauss (demagnetize) the monitor, adjust the moire cancellation level, change the menu position, and lock the controls.

- 1 Press the center of the control button.**
The main MENU appears on the screen.
- 2 Move the control button to highlight  OPTION and press the center of the control button again.**
The OPTION menu appears on the screen.
- 3 Move the control button \downarrow/\uparrow to select the desired adjustment item.**
Adjust the selected item according to the following instructions.

Degaussing the screen

The monitor is automatically demagnetized (degaussed) when the power is turned on.

To manually degauss the monitor, first move the control button \downarrow/\uparrow to select  (DEGAUSS). Then move the control button \rightarrow .

The screen is degaussed for about 5 seconds. If a second degauss cycle is needed, allow a minimum interval of 20 minutes for the best result.

Adjusting the moire*

If elliptical or wavy patterns appear on the screen, adjust the moire cancellation level.

To adjust the amount of moire cancellation, first move the control button \downarrow/\uparrow to select  (MOIRE ADJUST). Then move the control button \leftarrow/\rightarrow until the moire effect is at a minimum.



* Moire is a type of natural interference which produces soft, wavy lines on your screen. It may appear due to interference between the pattern of the picture on the screen and the phosphor pitch pattern of the monitor.

Example of moire







Changing the menu's position

Change the menu's position if it is blocking an image on the screen.

To change the menu's on-screen position, first move the control button \downarrow/\uparrow to select  (OSD H POSITION) for horizontal adjustment, or  (OSD V POSITION) for vertical adjustment. Then move the control button \leftarrow/\rightarrow to shift the on-screen menu.

Locking the controls

To protect adjustment data by locking the controls, first move the control button \downarrow/\uparrow to select  (CONTROL LOCK). Then move the control button \rightarrow , to select ON. Only the  (power) switch, EXIT, and  (CONTROL LOCK) of the  OPTION menu will operate. If any other items are selected, the  mark appears on the screen.

To cancel the control lock

Repeat the procedure above and set  (CONTROL LOCK) to OFF.

Helpful hints and information (HELP)

The HELP menu contains helpful hints and information about this monitor. If your monitor is displaying symptoms that match those listed in the HELP menu, follow the on-screen instructions to resolve the problem. If the symptoms do not match those listed in the HELP menu or if the problem persists, see “Trouble symptoms and remedies” on page 14.

1 Press the center of the control button.

The main MENU appears on the screen.

2 Move the control button to highlight HELP and press the center of the control button again.

The following HELP menu appears on the screen.

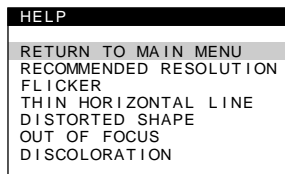

3 Move the control button / to select a HELP menu item and press the center of the control button again.

Instructions or information to resolve the problem appears on the screen. An explanation of each menu item is given below.

RECOMMENDED RESOLUTION

If the picture does not fill the screen to the edges or if the picture appears too large for the screen, adjust the resolution to the figures shown in the menu using your computer. If the input signal matches one of this monitor’s factory preset modes, the resolution and refresh rate of the current input signal are displayed.

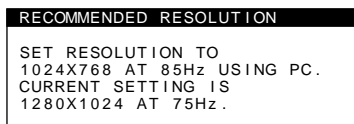

FLICKER

If the picture is flickering, adjust the refresh rate to figures shown in the menu. If the input signal matches one of this monitor’s factory preset modes, the refresh rate of the current input signal is displayed.

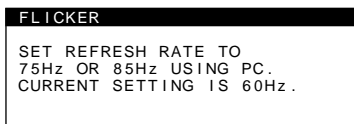

THIN HORIZONTAL LINE

The lines that appear on your screen are damper wires. See page 13 for more information about the damper wires.



DISTORTED SHAPE

If the shape of the picture on the screen seems distorted, try adjusting the picture’s geometry. Move the control button  to jump directly to the GEOMETRY menu.

OUT OF FOCUS

The picture may seem to be out of focus when the red and blue color signals are not aligned properly, causing red or blue shadows to appear around letters and lines. Try adjusting the picture’s convergence to make the shadows disappear. Move the control button  to jump directly to the CONVERGENCE menu. When the CONVERGENCE menu is displayed, the contrast, brightness and moire adjustment settings are automatically reset for all input signals.

DISCOLORATION

If the picture’s color appears abnormal in certain areas of the screen, first check for any loose signal cables. After you have checked the cables, try degaussing (demagnetizing) the screen manually. Move the control button  to jump directly to the OPTION menu, then select  (DEGAUSS).

Resetting the adjustments

This monitor has the following three reset methods. Use the RESET button to reset the adjustments.

RESET



Resetting a single adjustment item

Use the control button to select the adjustment item you want to reset, and press the RESET button.

Resetting all of the adjustment data for the current input signal

Press the RESET button when no menu is displayed on the screen. Note that the following items are not reset by this method:

- on-screen menu language (page 7)
- on-screen menu position (page 11)
- control lock (page 11)

Resetting all of the adjustment data for all input signals

Press and hold the RESET button for more than two seconds.

Note

The RESET button does not function when  (CONTROL LOCK) is set to ON.

Technical Features

Preset and user modes

When the monitor receives an input signal, it automatically matches the signal to one of the factory preset modes stored in the monitor's memory to provide a high quality picture at the center of the screen. (See Appendix for a list of the factory preset modes.) For input signals that do not match one of the factory preset modes, the digital Multiscan technology of this monitor ensures that a clear picture appears on the screen for any timing in the monitor's frequency range (horizontal: 30 – 85 kHz, vertical: 48 – 120 Hz). If the picture is adjusted, the adjustment data is stored as a user mode and automatically recalled whenever the same input signal is received.

Note for Windows users

For Windows users, check your video board manual or the utility program which comes with your graphic board and select the highest available refresh rate to maximize monitor performance.

Power saving function

This monitor meets the power-saving guidelines set by VESA, ENERGY STAR, and NUTEK. If the monitor is connected to a computer or video graphics board that is DPMS (Display Power Management Signaling) compliant, the monitor will automatically reduce power consumption in three stages as shown below.

Power mode	Power consumption	⏻ (power) indicator
normal operation	≤ 120 W	green
1 standby	≤ 15 W	green and orange alternate
2 suspend (sleep)*	≤ 15 W	green and orange alternate
3 active off** (deep sleep)*	≤ 3 W	orange
power off	0 W	off

- * "Sleep" and "deep sleep" are power saving modes defined by the Environmental Protection Agency.
- ** When your computer is in a power saving mode, MONITOR IS IN POWER SAVE MODE appears on the screen if you press any button on the monitor. After a few seconds, the monitor enters the power saving mode again.
- *** Power consumption of 0 W is achievable by disconnecting the power cord from the power outlet.

Troubleshooting

Before contacting technical support, refer to this section.

If thin lines appear on your screen (damper wires)

The lines you are experiencing on your screen are normal for the Trinitron monitor and are not a malfunction. These are shadows from the damper wires used to stabilize the aperture grille and are most noticeable when the screen's background is light (usually white). The aperture grille is the essential element that makes a Trinitron picture tube unique by allowing more light to reach the screen, resulting in a brighter, more detailed picture.

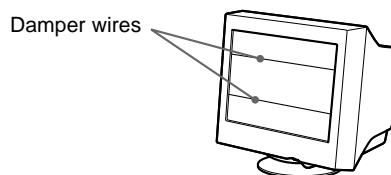

On-screen messages

If no picture appears on the screen, one of the following messages appears on the screen. To solve the problem, see "Trouble symptoms and remedies" on page 14.

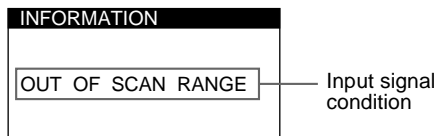

The input signal condition OUT OF SCAN RANGE

indicates that the input signal is not supported by the monitor's specifications.

NO INPUT SIGNAL

indicates that no signal is input.

MONITOR IS IN POWER SAVE MODE

indicates that the computer is in power saving mode. This message is displayed only when your computer is in a power saving mode and you press any one of the buttons on the monitor.

Trouble symptoms and remedies

If the problem is caused by the connected computer or other equipment, please refer to the connected equipment's instruction manual. Use the self-diagnosis function (back cover) if the following recommendations do not resolve the problem.

Symptom	Check these items
No picture	
If the ⏻ (power) indicator is not lit	<ul style="list-style-type: none"> • Check that the power cord is properly connected. • Check that the ⏻ (power) switch is in the "on" position.
If the NO INPUT SIGNAL message appears on the screen, or if the ⏻ (power) indicator is either orange or alternating between green and orange	<ul style="list-style-type: none"> • Check that the video signal cable is properly connected and all plugs are firmly seated in their sockets (page 6). • Check that the HD15 video input connector's pins are not bent or pushed in. <p>■ Problems caused by the connected computer or other equipment</p> <ul style="list-style-type: none"> • Check that the computer's power is "on." • Check that the graphic board is completely seated in the proper bus slot.
If the MONITOR IS IN POWER SAVE MODE message appeared on the screen, or if the ⏻ (power) indicator is either orange or alternating between green and orange	<p>■ Problems caused by the connected computer or other equipment</p> <ul style="list-style-type: none"> • The computer is in power saving mode. Try pressing any key on the computer keyboard. • Check that the computer's power is "on." • Check that the graphic board is completely seated in the proper bus slot.
If the OUT OF SCAN RANGE message appears on the screen	<p>■ Problems caused by the connected computer or other equipment</p> <ul style="list-style-type: none"> • Check that the video frequency range is within that specified for the monitor. If you replaced an old monitor with this monitor, reconnect the old monitor and adjust the frequency range to the following. Horizontal: 30 – 85 kHz Vertical: 48 – 120 Hz
If no message is displayed and the ⏻ (power) indicator is green or flashing orange	<ul style="list-style-type: none"> • Use the Self-diagnosis function (back cover).
If using a Macintosh system	<ul style="list-style-type: none"> • Check that the Macintosh adapter (not supplied) and the video signal cable are properly connected (page 6).
Picture flickers, bounces, oscillates, or is scrambled	<ul style="list-style-type: none"> • Isolate and eliminate any potential sources of electric or magnetic fields such as other monitors, laser printers, electric fans, fluorescent lighting, or televisions. • Move the monitor away from power lines or place a magnetic shield near the monitor. • Try plugging the monitor into a different AC outlet, preferably on a different circuit. • Try turning the monitor 90° to the left or right. <p>■ Problems caused by the connected computer or other equipment</p> <ul style="list-style-type: none"> • Check your graphics board manual for the proper monitor setting. • Confirm that the graphics mode (VESA, Macintosh 16" Color, etc.) and the frequency of the input signal are supported by this monitor (back cover). Even if the frequency is within the proper range, some video boards may have a sync pulse that is too narrow for the monitor to sync correctly. • Adjust the computer's refresh rate (vertical frequency) to obtain the best possible picture.
Picture is fuzzy	<ul style="list-style-type: none"> • Adjust the brightness and contrast (page 9). • Degauss the monitor* (page 11). • Select MOIRE ADJUST and adjust the moire cancellation effect (page 11).
Picture is ghosting	<ul style="list-style-type: none"> • Eliminate the use of video cable extensions and/or video switch boxes. • Check that all plugs are firmly seated in their sockets.
Picture is not centered or sized properly	<ul style="list-style-type: none"> • Adjust the size (page 9) or centering (page 9). Note that some video modes do not fill the screen to the edges.

Symptom	Check these items
Edges of the image are curved	<ul style="list-style-type: none"> Adjust the geometry (page 10).
Wavy or elliptical pattern (moire) is visible	<ul style="list-style-type: none"> Select MOIRE ADJUST and adjust the moire cancellation effect (page 11). <p>■ Problems caused by the connected computer or other equipment</p> <ul style="list-style-type: none"> Change your desktop pattern.
Color is not uniform	<ul style="list-style-type: none"> Degauss the monitor* (page 11). If you place equipment that generates a magnetic field, such as a speaker, near the monitor, or if you change the direction the monitor faces, color may lose uniformity.
White does not look white	<ul style="list-style-type: none"> Adjust the color temperature (page 10).
Letters and lines show red or blue shadows at the edges	<ul style="list-style-type: none"> Adjust the convergence (page 10).
Monitor buttons do not operate	<ul style="list-style-type: none"> If the control lock is set to ON, set it to OFF (page 11).
A hum is heard right after the power is turned on	<ul style="list-style-type: none"> This is the sound of the auto-degauss cycle. When the power is turned on, the monitor is automatically degaussed for five seconds.

* If a second degauss cycle is needed, allow a minimum interval of 20 minutes for the best result. A humming noise may be heard, but this is not a malfunction.

Displaying this monitor's name, serial number, and date of manufacture.



While the monitor is receiving a video signal, press and hold the center of the control button for more than five seconds to display this monitor's information box.

If the problem persists, call your authorized Sony dealer and give the following information.

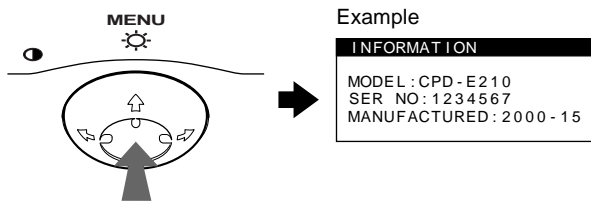
- Model name: CPD-E210
- Serial number
- Name and specifications of your computer and graphics board.



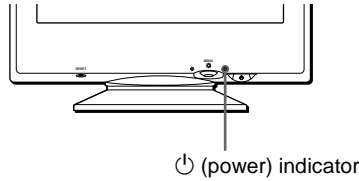

Self-diagnosis function

This monitor is equipped with a self-diagnosis function. If there is a problem with your monitor or computer, the screen will go blank and the  (power) indicator will either light up green or flash orange. If the  (power) indicator is lit in orange, the computer is in power saving mode. Try pressing any key on the keyboard.



If the (power) indicator is green

- 1 **Disconnect the video input cable or turn off the connected computer.**
- 2 **Press the  (power) button twice to turn the monitor off and then on.**
- 3 **Move the control button  for 2 seconds before the monitor enters power saving mode.**

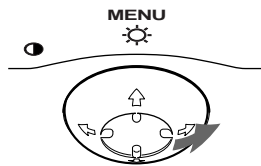



If all four color bars appear (white, red, green, blue), the monitor is working properly. Reconnect the video input cable and check the condition of your computer.

If the color bars do not appear, there is a potential monitor failure. Inform your authorized Sony dealer of the monitor's condition.

If the (power) indicator is flashing orange

Press the  (power) button twice to turn the monitor off and then on.

If the  (power) indicator lights up green, the monitor is working properly.

If the  (power) indicator is still flashing, there is a potential monitor failure. Count the number of seconds between orange flashes of the  (power) indicator and inform your authorized Sony dealer of the monitor's condition. Be sure to note the model name and serial number of your monitor. Also note the make and model of your computer and video board.

Specifications

CRT	0.24 mm aperture grille pitch (center) 17 inches measured diagonally 90-degree deflection FD Trinitron
Viewable image size	Approx. 327 × 243 mm (w/h) (14 ³ / ₄ × 9 ⁵ / ₈ inches) 16.0" viewing image
Resolution	
Maximum	Horizontal: 1600 dots Vertical: 1200 lines
Recommended	Horizontal: 1024 dots Vertical: 768 lines
Standard image area	Approx. 312 × 234 mm (w/h) (12 ³ / ₈ × 9 ¹ / ₄ inches)
Deflection frequency*	Horizontal: 30 to 85 kHz Vertical: 48 to 120 Hz
AC input voltage/current	100 to 240 V, 50 – 60 Hz, Max. 1.7 A
Power consumption	120 W
Dimensions	Approx. 404 × 413.5 × 419.5 mm (w/h/d) (16 × 16 ³ / ₈ × 16 ³ / ₈ inches)
Mass	Approx. 20 kg (44 lb 1 oz)
Plug and Play	DDC1/DDC2B/DDC2Bi
Supplied accessories	See page 6

* Recommended horizontal and vertical timing condition

- Horizontal sync width should be more than 1.0 μsec.
- Horizontal blanking width should be more than 3.0 μsec.
- Vertical blanking width should be more than 500 μsec.

Design and specifications are subject to change without notice.

Preset mode timing table

No.	Resolution (dots × lines)	Horizontal Frequency	Vertical Frequency	Graphics Mode
1	640 × 480	31.5 kHz	60 Hz	VGA-G
2	640 × 480	43.3 kHz	85 Hz	VESA
3	720 × 400	31.5 kHz	70 Hz	VGA-Text
4	800 × 600	53.7 kHz	85 Hz	VESA
5	832 × 624	49.7 kHz	75 Hz	Macintosh 16" Color
6	1024 × 768	60.0 kHz	75 Hz	VESA
7	1024 × 768	68.7 kHz	85 Hz	VESA
8	1280 × 1024	80.0 kHz	75 Hz	VESA