

Portable CD Player

Operating Instructions



Atrac3plus

“WALKMAN” is a registered trademark of Sony Corporation to represent Headphone Stereo products.  is a trademark of Sony Corporation.

D-NE518CK

WARNING

To prevent fire or shock hazard, do not expose the unit to rain or moisture.

Do not install the appliance in a confined space, such as a bookcase or built-in cabinet.

To prevent fire, do not cover the ventilation of the apparatus with newspapers, tablecloths, curtains, etc. And don't place lighted candles on the apparatus.

To prevent fire or shock hazard, do not place objects filled with liquids, such as vases, on the apparatus.

CAUTION

The use of optical instruments with this product will increase eye hazard.

Certain countries may regulate disposal of the battery used to power this product. Please consult with your local authority.

CAUTION

- INVISIBLE LASER RADIATION WHEN OPEN
- DO NOT STARE INTO BEAM OR VIEW DIRECTLY WITH OPTICAL INSTRUMENTS

The validity of the CE marking is restricted to only those countries where it is legally enforced, mainly in the countries EEA (European Economic Area).

ATRAC3plus and ATRAC3 are trademarks of Sony Corporation.

Owner's Record

The model and serial numbers are located at the rear of the CD player. Record the serial number in the space provided below. Refer to these numbers whenever you call upon your Sony dealer regarding this product.

Model No. D-NE518CK

Serial No. _____

For the customers in the USA

This equipment has been tested and found to comply with the limits for a Class B digital device, pursuant to Part 15 of the FCC Rules. These limits are designed to provide reasonable protection against harmful interference in a residential installation. This equipment generates, uses, and can radiate radio frequency energy and, if not installed and used in accordance with the instructions, may cause harmful interference to radio communications. However, there is no guarantee that interference will not occur in a particular installation. If this equipment does cause harmful interference to radio or television reception, which can be determined by turning the equipment off and on, the user is encouraged to try to correct the interference by one or more of the following measures:

- Reorient or relocate the receiving antenna.
- Increase the separation between the equipment and receiver.
- Connect the equipment into an outlet on a circuit different from that to which the receiver is connected.
- Consult the dealer or an experienced radio/TV technician for help.

You are cautioned that any changes or modifications not expressly approved in this manual could void your authority to operate this equipment.

Product registration

For the customers in the USA

Please register this product on line at www.sony.com/walkmanreg
<<http://www.sony.com/walkmanreg>>

Proper registration will enable us to send you periodic mailings about software upgrades, new products, services and other important announcements. Thank you.

If you have any questions about this product, contact:
www.sony.com/walkmansupport

Sony Network Portable Audio Support Line
1-(866)-456-7669

Sony Customer Information Service Center
12451 Gateway Blvd., Ft. Myers, FL 33913

Table of Contents

Enjoy your ATRAC CD Walkman!

Create original ATRAC CDs!	4
Music sources playable on this CD player ..	6
ATRAC3plus and ATRAC3	6
MP3 files	6
Difference between ATRAC3plus/ATRAC3 and MP3	8

Getting started

Locating the controls	9
Checking the supplied accessories	10

Playing an audio CD or ATRAC3plus/ATRAC3/MP3 files

1. Connect your CD player.	11
2. Insert a CD.	11
3. Play a CD.	11

Playback options

Playing tracks in random order (Shuffle play)	17
Playing all files in a selected group in random order (Group shuffle play) (ATRAC/MP3 CD only)	17
Playing your favorite tracks by adding Bookmarks (Bookmark track play)	18
Playing your favorite play lists (m3u play list play) (MP3 CD only)	19
Searching for your favorite tracks/files/ groups quickly using the JOG DIAL	20

Available features

The G-PROTECTION function	21
Checking the time remaining on the CD and the number of tracks left (audio CD)	21
Checking information on a CD with ATRAC3plus/ATRAC3/MP3 files	22
Emphasizing the bass sound (SOUND)	22
Protecting your hearing (AVLS)	23
Locking the controls (HOLD)	23
Turning off the operation beep sound	23

Using in a car

Installing in a car	24
Where to place your CD player	24
Mounting your CD player	24
Replacing the fuse of the car battery cord .	25
Mounting the rotary commander	26

Connecting to a power source

Using the dry batteries	27
Notes on the power source	28

Connecting your CD player

Connecting a stereo system	29
----------------------------------	----

Additional information

Precautions	30
Maintenance	30
Troubleshooting	31
Specifications	33
Optional accessories	34

Enjoy your ATRAC CD Walkman!

Thank you for purchasing the D-NE518CK. This CD Walkman is called an “ATRAC CD Walkman,” because you can enjoy “ATRAC CDs” on it.

Create original ATRAC CDs!

You can make your own ATRAC CD.

The procedure is very simple. Just perform Steps 1, 2 and 3.

Step 1 Install

Install the supplied
“SonicStage Simple
Burner” software.



Step 2 Burn

Create a disc image and burn it on
a CD-R/RW using your PC.

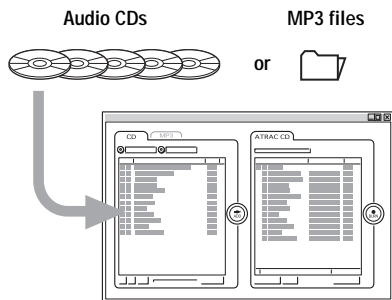

Audio data is converted to the ATRAC3plus/
ATRAC3 format by the SonicStage Simple
Burner.

How to use the SonicStage Simple Burner

Refer to the supplied booklet “SonicStage Simple Burner.”

What is an ATRAC CD?

An ATRAC CD is a CD-R/RW on which audio data compressed in the ATRAC3plus/ATRAC3 format has been recorded. About 30 audio CDs* can be recorded on a CD-R/RW. You can also record MP3 files by converting the files to the ATRAC3plus/ATRAC3 format.

*When recorded at 48 kbps (ATRAC3plus format)

ATRAC CD

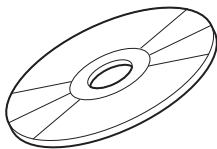

Step 3 Listen

You can enjoy listening to your own ATRAC CDs on your ATRAC CD Walkman.



You can also enjoy audio CDs on your CD Walkman.

What is the ATRAC3plus/ATRAC3 format?

Refer to pages 6 - 8 of this manual.

Music sources playable on this CD player

You can play the following 3 music sources on this CD player:

- Audio CDs
- ATRAC3plus/ATRAC3 format files
- MP3 files

Usable disc formats

You can use ISO 9660 Level 1/2, Joliet extension and UDF 1.5 (Packet write) format discs only.

ATRAC3plus and ATRAC3

“ATRAC3plus,” which stands for “Adaptive Transform Acoustic Coding3plus” is audio compression technology, developed from the ATRAC3 format. Though the ATRAC3plus format can compress music content to about 1/20 of its original size, you can still enjoy high quality sound. The available transfer bit rates are 64 kbps and 48 kbps.

“ATRAC3,” which stands for “Adaptive Transform Acoustic Coding3” is audio compression technology that satisfies the demand for high sound quality and high compression rates. The ATRAC3 format can compress music content to about 1/10 of their original size, which contributes to reduction of the media volume. The available transfer bit rates are 132 kbps, 105 kbps and 66 kbps.

The usable number of groups and files

- Maximum number of groups: 255
- Maximum number of files: 999

For details, refer to the supplied booklet “SonicStage Simple Burner.”

MP3 files

MP3, which stands for MPEG-1 Audio Layer3, a standard for audio files compression supported by the Motion Picture Experts Group, an ISO (International Organization for Standardization) working group, enables compression of audio files to about 1/10 of the data size of a standard compact disc. Since the MP3 encoding algorithm is public, there are various encoders/decoders that are compliant with this standard, including freeware that is available for no charge. Thus, the MP3 standard is widely used in the computer field.

The major specifications of the acceptable disc format are:

- Maximum directory levels: 8
- Acceptable characters for a file/folder name:
A - Z, a - z, 0 - 9, _ (underscore)

Notes

- When naming files, be sure to add the file extension “mp3” to the file name.
- If you add the extension “mp3” to a file other than an MP3 file, the player will not be able to recognize the file properly.
- The file name does not correspond to the ID3 tag.

The usable number of groups and files

- Maximum number of groups: 100
- Maximum number of files: 400

Settings for compression and writing software

- This CD player supports MP3 files with the following specifications: transfer bit rate: 16 - 320 kbps and sampling frequencies: 32/44.1/ 48 kHz. Variable Bit Rate (VBR) is also supported.
To compress a source for an MP3 file, we recommend setting the transfer bit rate of the compression software to “44.1 kHz,” “128 kbps,” and “Constant Bit Rate.”
- To record up to the maximum capacity, set to “halting of writing.”
- To record at one time up to the maximum capacity on media that has nothing recorded on it, set to “Disc at Once.”

Note on saving files on the media

When a disc is inserted, the CD player reads all the files on that disc. If there are many groups or if there are files in a different format on the disc, it may take a long time for play to begin or for the next file to start play.

We recommend that you do not save files in other formats or unnecessary groups on a disc that has MP3 files.

Difference between ATRAC3plus/ATRAC3 and MP3

Groups and folders

The ATRAC3plus/ATRAC3 format has a very simple structure. It consists of “files” and “groups.” A “file” is equivalent to a “track” of an audio CD. A “group” is a bundle of files and is equivalent to an “album.” A “group” has no directory-type structure (a new group cannot be made within an existing group). This CD player is designed to recognize an MP3 file folder as a “group” so that it can play CD-Rs/RWs recorded in both the ATRAC3plus/ATRAC3 format and those recorded in the MP3 format with the same operation.

Displaying the track name, etc.

When playing a CD having ATRAC3plus/ATRAC3 files or MP3 files on this CD player, track names, artist names and album names are displayed. This CD player conforms to Version 1.1/2.2/2.3 of the ID3 tag format*.

*ID3 tag is a format for adding certain information (track name, album name, artist name, etc.) to MP3 files.

Notes

- This CD player cannot record music content on recordable media, such as CD-Rs/RWs.
- CD-Rs/RWs recorded in the ATRAC3plus/ATRAC3 format cannot be played on your computer.
- Playback capability may vary depending on the quality of the disc and the condition of the recording device.

Locating the controls

For details, see pages in parentheses.

CD player (front)

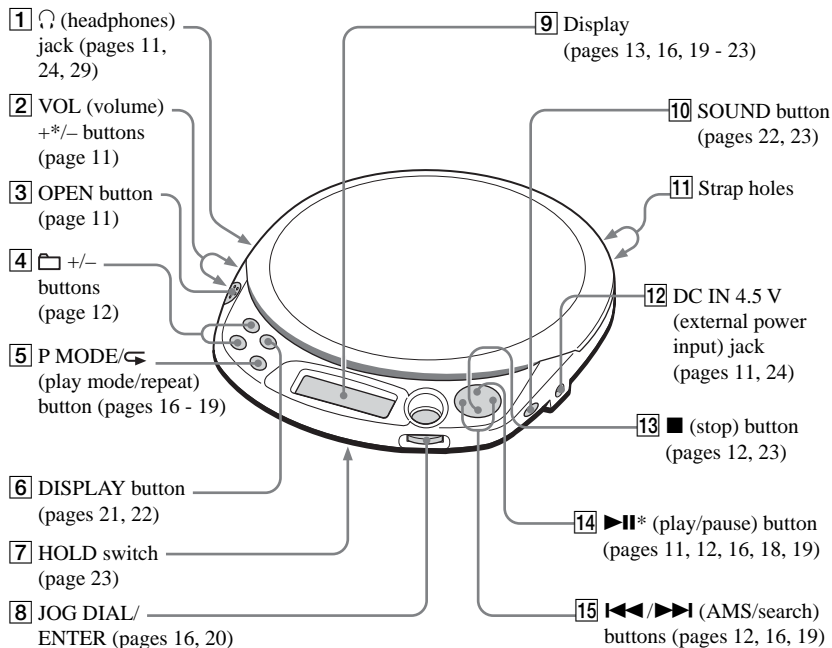

*The button has a tactile dot.

CD player (inside)

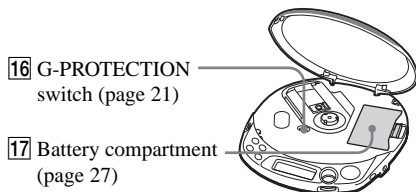

(Continued)

Rotary commander

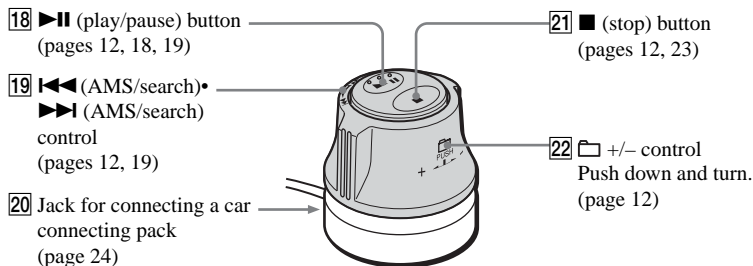

Note

The supplied rotary commander should be used with this player only.

Checking the supplied accessories

AC power adaptor (1)

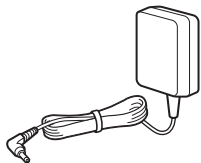

Headphones (1)



Rotary commander (1)

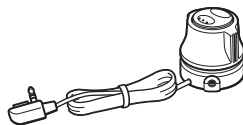

Car battery cord (1)



Car connecting pack (1)

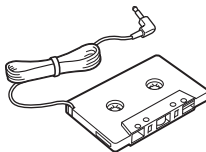

Velcro tapes for the CD player (2)

Velcro tape for the rotary commander (1)

CD-ROM (SonicStage Simple Burner) (1)

User's guide for SonicStage Simple Burner (1)

For US customers

The AC power adaptor supplied is not intended to be serviced. Should the AC power adaptor cease to function in its intended manner, during the warranty period, the adaptor should be returned to your nearest Sony Service Center or Sony Authorized Repair Center for replacement, or after warranty period, it should be discarded.

Playing an audio CD or ATRAC3plus/ATRAC3/MP3 files

When using your CD player in a car, see page 24.

1. Connect your CD player.

- 1 Connect the AC power adaptor.
 - 2 Connect the headphones/earphones.
- You can also use dry batteries as a power source. (See page 27.)

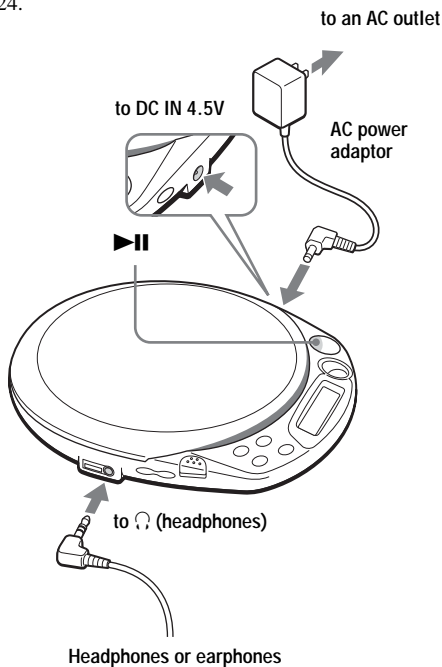

2. Insert a CD.

- 1 Press OPEN to open the lid.

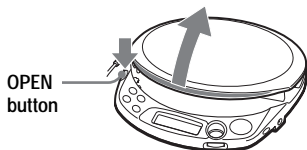

- 2 Place the CD on the tray and close the lid.

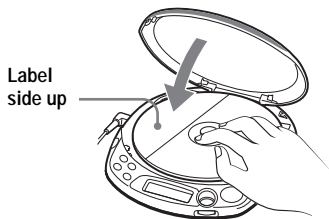

3. Play a CD.

Press **▶▶**.



Adjust the volume by pressing VOL + or -.

You can also adjust the volume on the car cassette deck.

(Continued)

Basic operations

To	Do this
Play (from the point you stopped)	Press ▶▶ . Playback starts from the point you stopped.
Play (from the first track)	While the CD player is stopped, press and hold ▶▶ until the play of the first track starts.
Pause/resume play after pause	Press ▶▶ .
Stop	Press ■ . ^{*2}
Find the beginning of the current track (AMS ^{*1})	Press ◀◀ once quickly. ^{*2}
Find the beginning of previous tracks (AMS)	Press ◀◀ repeatedly. ^{*2, *3}
Find the beginning of the next track (AMS)	Press ▶▶ once quickly. ^{*2, *3}
Find the beginning of succeeding tracks (AMS)	Press ▶▶ repeatedly. ^{*2, *3}
Go backwards quickly ^{*4}	Hold down ◀◀ . ^{*2}
Go forward quickly ^{*4}	Hold down ▶▶ . ^{*2}
Jump to succeeding groups ^{*5}	Press ◻ + repeatedly.
Jump to previous groups ^{*5}	Press ◻ - repeatedly.

*1 Automatic Music Sensor

*2 These operations can be done during both play and pause.

*3 After you have played the last track, you can return to the beginning of the first track by pressing **▶▶**.
Similarly, if you are at the first track, you can locate the last track by pressing **◀◀**.

*4 Does not function when you play an MP3 CD recorded in the UDF 1.5 (Packet write) format.

*5 Only when you play an ATRAC/MP3 CD

Removing the CD

Remove the CD while pressing the pivot in the center of the tray.

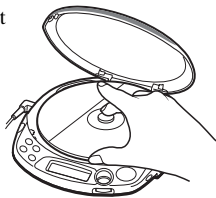

About CD-Rs/RWs

This CD player can play CD-Rs/RWs recorded in the CD-DA format*, but playback capability may vary depending on the quality of the disc and the condition of the recording device.

* CD-DA is the abbreviation for Compact Disc Digital Audio. It is a recording standard used for the Audio CDs.

Music discs encoded with copyright protection technologies

This product is designed to play back discs that conform to the Compact Disc (CD) standard. Recently, various music discs encoded with copyright protection technologies are marketed by some record companies. Please be aware that among those discs, there are some that do not conform to the CD standard and may not be playable by this product.

About the display

While the CD player is playing, the following indications appear in the display.

You can also check the remaining time, track name, etc. using DISPLAY (see pages 21 and 22).

While playing an audio CD

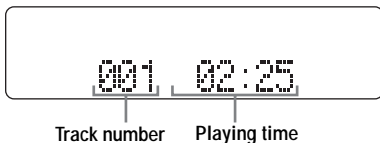

While playing an audio CD containing CD text information

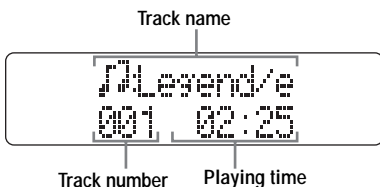

While playing an ATRAC3plus/ATRAC3 file

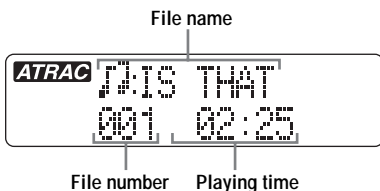

When playing an MP3 file

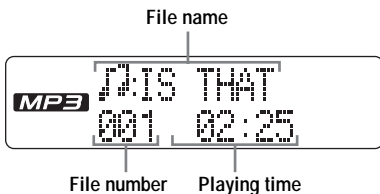

Note

Before playing a file, the CD player reads all file and group information on the CD. "READING" is displayed. Depending on the content of the CD, it may take some time to accomplish this reading.

(Continued)

Example of ATRAC3plus/ATRAC3 groups and files

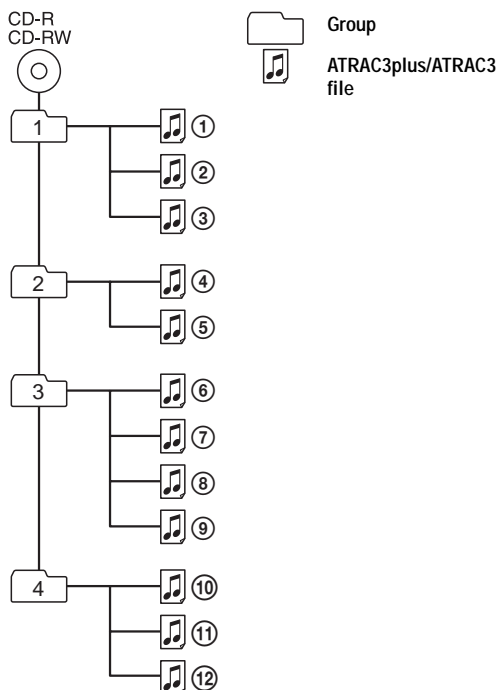

File mode	Plays all ATRAC3plus/ATRAC3 files from ①, ②, ③...⑪, ⑫.
-----------	--

Group mode	Plays all ATRAC3plus/ATRAC3 files in the selected group.
------------	--

Notes

- Maximum number of groups: 255
- Maximum number of files: 999
- The characters A - Z, a - z, 0 - 9, and _ can be displayed on this CD player.
- When referring to ATRAC CDs, “group” is equivalent to an “album” and “file” is equivalent to a “track.”

Example of group structure and playing order (MP3 CD)

The playing order of groups and files is as follows:

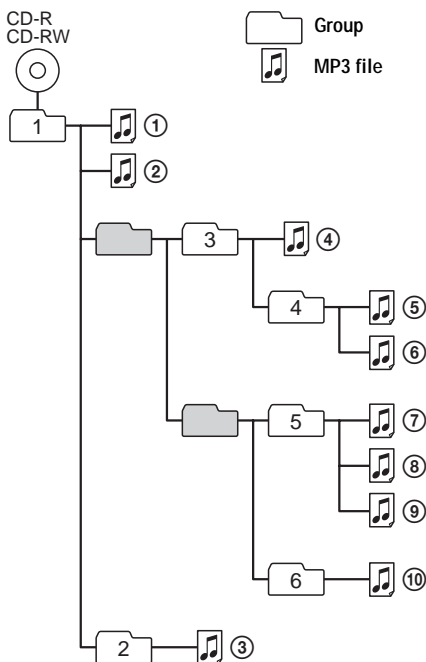

File mode	Plays all MP3 files from ①, ②, ③...⑨, ⑩.
Group mode	Plays all MP3 files in the selected group. (Example: If you select group 3, the CD player plays file ④. If you select group 4, the CD player plays file ⑤ and ⑥.)

Notes

- A group that does not include an MP3 file is skipped.
- Maximum number of groups: 100
Maximum number of files: 400
- Maximum directory levels: 8
- The characters A - Z, a - z, 0 - 9, and _ can be displayed on this CD player.
- When referring to MP3 CDs, "group" is equivalent to an "album" and "file" is equivalent to a "track."

Playback options

You can enjoy various playback options using P MODE/↶ button, JOG DIAL/ENTER, ◀▶▶▶ and ▶▶.

P MODE/↶ button

If you press the button, you can change the play mode.

During playback, if you press and hold the button until "↶" appears, you can play tracks repeatedly in the play mode that was selected using P MODE/↶.

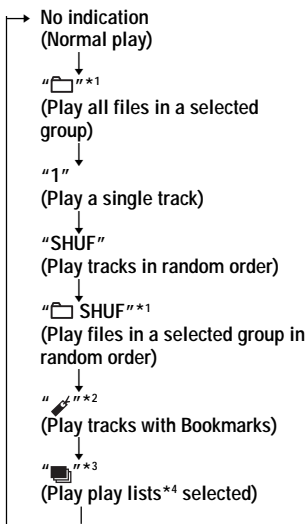

*1 ATRAC/MP3 CD only

*2 Only when Bookmarks have been added to the tracks/files

*3 MP3 CD only

*4 Play lists (m3u) recorded in MP3 format only

Display

Play mode

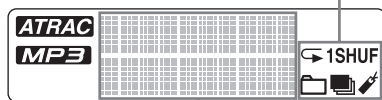

CD text information, ATRAC3plus/ATRAC3/MP3 file information, playing time, etc. are displayed.

JOG DIAL and ENTER

- **Turn JOG DIAL.**
You can select files or groups you want.
- **Press ENTER.**
You can switch the file/group search mode and also start play.

◀▶▶▶ buttons and ▶▶ button

- **Press ▶▶▶▶ or ◀◀◀.**
You can select a play list you want.
- **Press ▶▶.**
You can add Bookmarks and also start bookmark track play and play list play.

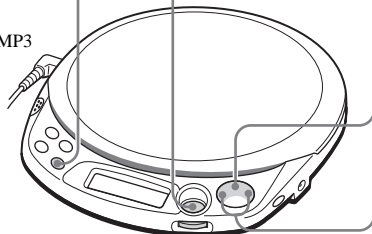

Playing tracks in random order (Shuffle play)

During playback, press **P MODE**/ repeatedly until “SHUF” appears.

When playing ATRAC3plus/ATRAC3/MP3 files

In shuffle mode, the CD player plays all files on a CD in random order.

Playing all files in a selected group in random order (Group shuffle play) (ATRAC/MP3 CD only)

During playback, press **P MODE**/ repeatedly until “ SHUF” appears.

When playing ATRAC3plus/ATRAC3/MP3 files

The CD player plays all files in a selected group in random order.

Playing your favorite tracks by adding Bookmarks (Bookmark track play)

You can add Bookmarks to up to 99 tracks for each CD. You can use this function for up to 10 CDs.



While playing ATRAC3plus/ATRAC3 files

You can add Bookmarks to up to 999 tracks for each CD (up to 5 CDs).



While playing MP3 files

You can add Bookmarks to up to 400 tracks for each CD (up to 10 CDs).

To add Bookmarks

- 1 During playback of the track to which you want to add a Bookmark, press and hold **▶||** until “ (Bookmark)” flashes in the display.
When the Bookmark has been added successfully, “” flashes slower.
- 2 Repeat step 1 to add Bookmarks to the tracks you want.

To listen to tracks with Bookmarks

- 1 Press **P MODE/⟲** repeatedly until “” flashes.
- 2 Press **▶||**.
“” lights up in the display and the playback of the tracks with the Bookmarks starts.

To remove Bookmarks

During playback of a track with a Bookmark, press and hold **▶||** until “” disappears from the display.

To check the tracks with Bookmarks

During playback of tracks with Bookmarks, “” flashes slowly in the display.

Notes



- During playback of tracks with Bookmarks, tracks are played in order of track number, and not in the order you added the Bookmarks.
- If you try to add Bookmarks to tracks on an 11th CD (on a 6th CD when playing ATRAC CDs), the Bookmarks of the CD you played back first will be erased.
- If you remove all power sources, all Bookmarks stored in memory will be erased.

Playing your favorite play lists (m3u play list play)

(MP3 CD only)

You can play your favorite m3u play lists.*

* An “m3u play list” is a file for which an MP3 file playing order has been encoded. To use the play list function, record MP3 files on a CD-R/RW using encoding software that supports the m3u format.

- 1** During playback, press **P MODE**/ repeatedly until “” appears.



Play list

- 2** Press **◀◀** or **▶▶** to select a play list you want.



- 3** Press **▶II**.

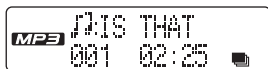

Note

You can only play the top two play lists displayed on your screen on this CD player.

Searching for your favorite tracks/files/groups quickly using the JOG DIAL

When using an audio CD

- 1 Turn the JOG DIAL to select the track you want.
- 2 Press ENTER.
The CD player starts play.

When using an ATRAC CD or MP3 CD

While the CD player is stopped

- 1 Turn the JOG DIAL to select the group you want.
- 2 Press ENTER.
The CD player enters the file search mode.
- 3 Turn the JOG DIAL to select the file you want.
- 4 Press ENTER.
The CD player starts play.

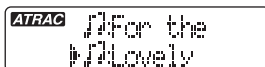
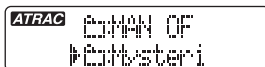

While the CD player is playing

- 1 Turn the JOG DIAL to select the file you want.
- 2 Press ENTER.
The CD player starts play.

To select another group while the CD player is in the file search mode

- 1 Turn the JOG DIAL to the left until "□:" appears.
- 2 Press ENTER.
"□: group name" appears and the CD player enters the group search mode.
- 3 Turn the JOG DIAL to select the group you want.
You can select the file you want by turning the JOG DIAL.

To cancel the search

While the CD player is in the group search mode:

Turn the JOG DIAL to the left until "CANCEL" appears. Press ENTER.

While the CD player is in the file search mode:

- 1 Turn the JOG DIAL to the left until "□:" appears. Press ENTER.
- 2 Turn the JOG DIAL to the left until "CANCEL" appears. Press ENTER.

Note

When using an ATRAC or MP3 CD, up to 400 file names or up to 100 group names can be displayed. If the number of files or groups surpasses these figures, a file number such as "401" or a group number such as "101" will be displayed instead of names.

The G-PROTECTION function

The G-PROTECTION function has been developed to provide excellent protection against sound skipping during many active uses.

When you set the G-PROTECTION switch on your CD player to “2,” the G-PROTECTION function will be enhanced compared to “1.”

To walk with the CD player and enjoy high quality CD sound using the G-PROTECTION function, set the G-PROTECTION switch to “1.” While taking harder exercise, it is recommended that you set it to “2.”

Note

Sound may skip:

- if the CD player receives stronger continuous shock than expected,
- if a dirty or scratched CD is played or
- when using poor-quality CD-Rs/RWs or if there is a problem with the original recording device or application software.

Checking the time remaining on the CD and the number of tracks left (audio CD)

Each time you press DISPLAY, the display changes as follows.

For an audio CD containing CD text information, information in parentheses also appears.

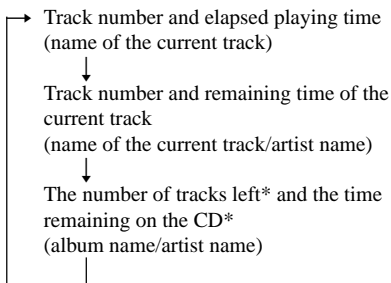

* Not displayed during Single play, Shuffle play or Bookmark track play.

Checking information on a CD with ATRAC3plus/ATRAC3/MP3 files

You can check information on a CD with ATRAC3plus/ATRAC3/MP3 files using DISPLAY.

You can also check ID3 tag information if the file has that information stored.

Each time you press DISPLAY, the display changes as follows:

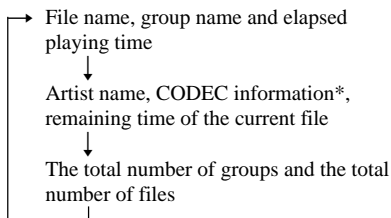

*Variable bit rate and sampling frequencies

Notes

- If the group does not have a group name, "ROOT" appears in the display.
- If the file does not have ID3 tag information, "- - -" appears in the display.

Emphasizing the bass sound (SOUND)

You can emphasize the bass-boosted sound.

Press SOUND to select "BASS ■" or "BASS ■■."

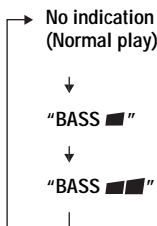

The selected sound mode is displayed.

"BASS ■■" enhances the bass sound more than "BASS ■."

Note

If the sound is distorted when using the SOUND function, turn down the volume.

Protecting your hearing (AVLS)

The AVLS (Automatic Volume Limiter System) function keeps down the maximum volume to protect your hearing.

Press and hold SOUND until “AVLS ON” appears in the display.

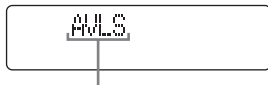

Flashes when the volume is turned up beyond a certain level.

To turn off the AVLS function

Press and hold SOUND until “AVLS OFF” appears in the display.

Note

If you use the SOUND function and the AVLS function at the same time, sound may be distorted. If this happens, turn down the volume.

Locking the controls (HOLD)

You can lock the controls on your CD player to prevent accidental button presses.

Slide HOLD in the direction of the arrow.

“HOLD” flashes if you press any button when the HOLD function is activated.

To unlock the controls

Slide HOLD in the opposite direction of the arrow.

Turning off the operation beep sound

You can turn off the beep sound that is heard from your headphones/earphones when you operate your CD player.

1 Remove the power source (AC power adaptor, dry batteries) from the CD player.

2 Connect the power source while pressing ■ for about one second or more.

To turn on the beep sound

Remove the power source and then connect the power source without pressing ■.

Installing in a car

- 1 **Connect your CD player as shown below.**

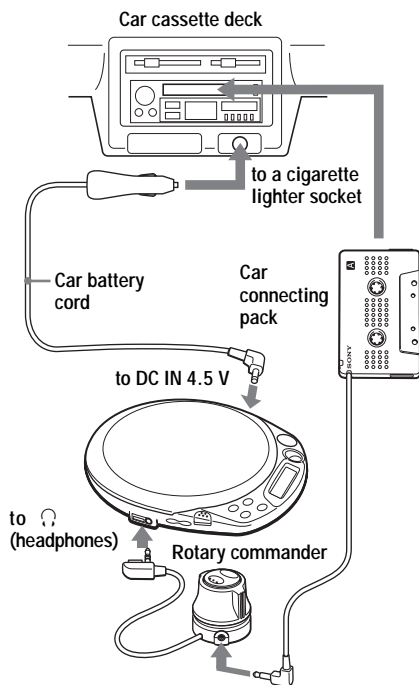

Note

Turn down the volume of the car cassette deck before inserting the car connecting pack.

- 2 **Insert a CD.**

- 3 **Play a CD.**

Where to place your CD player

- Install the CD player in a location which:
 - does not interfere with your driving.
 - is not dangerous for passengers.
 - does not interfere with the glove box lid or ashtray.
 - is stable, and where nothing around it may interfere with installation.
- Do not install the CD player near heat sources or where subject to direct sunlight, excessive dust, or moisture (especially on a dashboard.)

Please understand that we will not incur any obligations for troubles caused by incorrect installation.

If you have any questions or problems concerning your CD player, please contact your nearest Sony dealer.

Mounting your CD player

Attach the CD player to the console box with the supplied Velcro tapes.

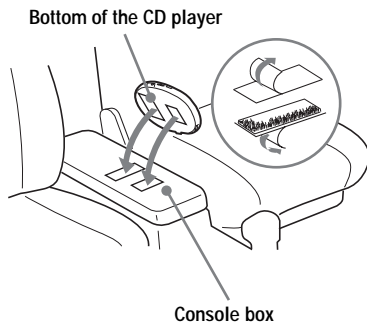

Notes

- Do not affix Velcro tapes to the name plate or any control.
- When you are going to park your car for a long period of time, remove the CD player from the console box and place it where it will not be exposed to direct sunlight.

Note on the car battery cord

The 4.5V DC plug supplied with car battery cord conforms to the proposed standards of the Japan Electronics and Information Technology Industries Association (JEITA). Do not connect it to other players.

Polarity of the plug
(JEITA standards)



Replacing the fuse of the car battery cord

If the CD player does not operate, check the fuse. If it is blown, replace it as follows:

- 1 Turn off the CD player and remove the cigarette lighter plug from the cigarette lighter socket.**
- 2 Remove the plug end by turning it counterclockwise.**
- 3 Remove the defective fuse from the plug.**
- 4 Insert a new fuse into the plug.**
- 5 Replace the plug end by turning it clockwise.**

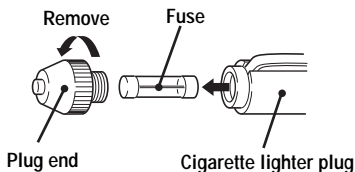

Notes

- Be sure to use a fuse of the same amperage and length as the one to be replaced. Never use a piece of wire as a substitute for the fuse.
- If the fuse is blown again after replacing it, contact your nearest Sony dealer. In such a case, bring the defective fuse to the dealer with you.

Notes on the car connecting pack

- If no sound is heard or the car connecting pack is ejected, change the direction of playback on the car cassette deck.
- Never insert the cord end of the car connecting pack into the cassette insertion door. Otherwise, the cord may break or the car cassette deck may be damaged.
- You cannot use the car connecting pack with some car cassette decks.
- The cord should be placed so that it does not hinder driving.
- To disconnect the cord from the CD player, pull it out by grasping the plug. Never pull the plug out by the cord.
- With some car cassette decks, you may hear some rattling noise from the car connecting pack. However, this is not a sign of malfunction.

Mounting the rotary commander

If you use the supplied rotary commander, you can control your CD player as easily as you would control the headlight or the wiper switch of your car while driving.

Attach the rotary commander to a flat place as illustrated below.

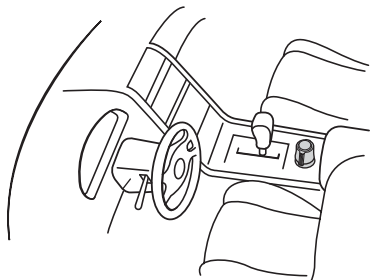

-
- 2** Secure the rotary commander to the flat place by pressing the Velcro tapes firmly together.

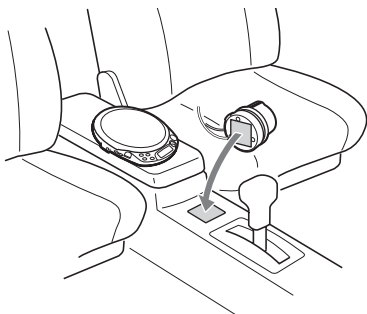

-
- 1** Attach the supplied Velcro tapes to the bottom of the rotary commander and to a flat place.

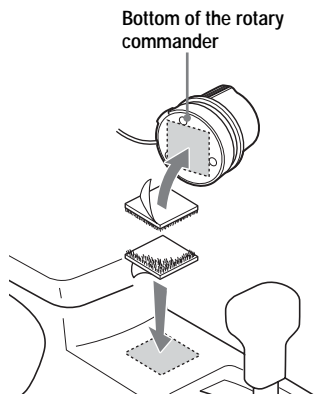

▶ Connecting to a power source

You can use the following power sources:

- AC power adaptor
- LR6 (size AA) alkaline batteries

For the battery life, see “Specifications.”

Using the dry batteries

Use only the following dry battery type for your CD player:

- LR6 (size AA) alkaline batteries

Note

Be sure to remove the AC power adaptor when using the dry batteries.

1 Open the battery compartment lid inside your CD player.

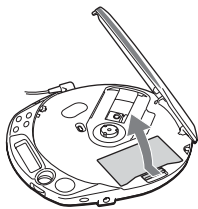

2 Insert two LR6 (size AA) batteries by matching the ⊕ to the diagram in the battery compartment and close the lid until it clicks into place.

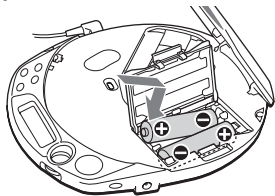

Insert ⊖ end first
(for both batteries).

To remove the batteries

Remove the batteries as illustrated below.

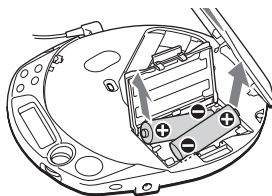

When to replace the batteries

You can check the remaining power of the batteries in the display.

Replace the batteries when “” flashes.





Lo batt*

* Beep sounds.

When the batteries are depleted, replace both batteries with new ones.

Notes

- The indicator sections of  roughly shows the remaining battery power. One section does not always indicate one-fourth of the battery power.
- Depending on operating conditions, the indicator sections of  may increase or decrease.

To attach the battery compartment lid

If the battery compartment lid is detached by an accidental drop, excessive force, etc., attach it as illustrated below.

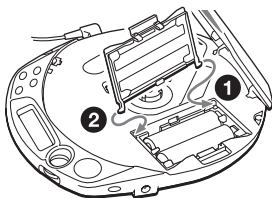

Notes on the power source

Disconnect all power sources when the CD player is not used for a long time.

On AC power adaptor

- Use only the AC power adaptor supplied. If your CD player is not supplied with the one, use the AC-E45HG AC power adaptor. Do not use any other AC power adaptor. It may cause a malfunction.

Polarity of the plug



- Do not touch the AC power adaptor with wet hands.
- Connect the AC power adaptor to an easily accessible AC outlet. Should you notice an abnormality in the AC power adaptor, disconnect it from the AC outlet immediately.

On dry batteries

- Do not throw the batteries into fire.
- Do not carry the batteries with coins or other metallic objects. It can generate heat if the positive and negative terminals of the battery are accidentally contacted by a metallic object.
- Do not mix new batteries with old ones.
- Do not use different types of batteries together.
- When the batteries are not to be used for a long time, remove them.
- If battery leakage occurs, wipe off any deposit in the battery compartment, and install new batteries. In case the deposit adheres to you, wash it off thoroughly.

Connecting a stereo system

You can listen to CDs through a stereo system and record CDs on a cassette tape. For details, see the instruction manual that comes with the connected device.

Be sure to turn off all connected devices before making connections.

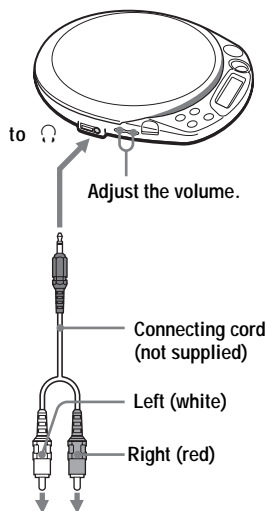

Stereo system,
cassette recorder,
radio cassette
recorder, etc.

Notes

- Before you play a CD, turn down the volume of the connected device to avoid damaging the connected speakers.
- Use the AC power adaptor for recording. If you use the dry batteries as a power source, batteries may become completely depleted during recording.
- Adjust the volume properly on the CD player and on the connected device so that the sound will not be distorted or noisy.

About the G-PROTECTION function when using the connecting cord

To record high quality CD sound, set the G-PROTECTION switch to "1."

Precautions

On safety

- Should any solid objects or liquid fall into the CD player, unplug it and have it checked by qualified personnel before operating it any further.
- Do not put any foreign objects in the DC IN 4.5 V (external power input) jack.

On the CD player

- Keep the lens on the CD player clean and do not touch it. If you do so, the lens may be damaged and the CD player will not operate properly.
- Do not put any heavy object on top of the CD player. The CD player and the CD may be damaged.
- Do not leave the CD player in a location near heat sources, or in a place subject to direct sunlight, excessive dust or sand, moisture, rain, mechanical shock, unlevelled surface, or in a car with its windows closed.
- If the CD player causes interference to the radio or television reception, turn off the CD player or move it away from the radio or television.
- Discs with non-standard shapes (e.g., heart, square, star) cannot be played on this CD player. Attempting to do so may damage the CD player. Do not use such discs.

On handling CDs

- To keep the CD clean, handle it by its edge. Do not touch the surface.
- Do not stick paper or tape onto the CD.

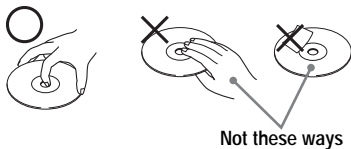

- Do not expose the CD to direct sunlight or heat sources such as hot air ducts. Do not leave the CD in a car parked under direct sunlight.

On headphones/earphones

Road safety

Do not use headphones/earphones while driving, cycling, or operating any motorized vehicle. It may create a traffic hazard and is illegal in some areas. It can also be potentially dangerous to play your headsets at high volume while walking, especially at pedestrian crossings. You should exercise extreme caution or discontinue use in potentially hazardous situations.

Preventing hearing damage

Avoid using headphones/earphones at high volume. Hearing experts advise against continuous, loud and extended play. If you experience a ringing in your ears, reduce volume or discontinue use.

Consideration for others

Keep the volume at a moderate level. This will allow you to hear outside sounds and to be considerate to the people around you.

Maintenance

To clean the casing

Use a soft cloth slightly moistened in water or a mild detergent solution. Do not use alcohol, benzine or thinner.



Troubleshooting

Should any problem persist after you have checked these symptoms, consult your nearest Sony dealer.

Symptom	Cause and/or corrective actions
The volume does not increase even if you press the VOL + button repeatedly.	→ If "AVLS" flashes in the display, press and hold SOUND until "AVLS OFF" appears in the display. (page 23)
No sound, or noise is heard.	→ Connect the plugs firmly. (page 11) → Plugs are dirty. Clean the plugs with a dry soft cloth periodically.
Certain files cannot be played.	→ You tried to play files saved in a format that is not compatible with this CD player. (page 6)
The playing time is too short when powered with the dry batteries.	→ Check that you are using alkaline batteries and not manganese batteries. (page 27) → Replace the batteries with new LR6 (size AA) alkaline batteries. (page 27)
"Lo batt" appears in the display. The CD does not play.	→ Replace the batteries with new LR6 (size AA) alkaline batteries. (page 27)
"HI dc In" appears in the display.	→ Use only the AC power adaptor or car battery cord in "Optional accessories." (page 34) → Remove all power sources, then insert the batteries or connect the AC power adaptor again. (pages 11, 27)
The CD does not play or "No disc" appears in the display when a CD is placed in the CD player.	→ The buttons are locked. Slide the HOLD switch back. (page 23) → The CD is dirty or defective. → Check that the CD is inserted with the label side up. (page 11) → Moisture condensation has occurred. Leave the CD player aside for several hours until the moisture evaporates. → Close the lid of the battery compartment firmly. (page 27) → Make sure the batteries are inserted correctly. (page 27) → Connect the AC power adaptor to an AC outlet securely. (page 11) → Press ► after one second or more has passed since the AC power adaptor was connected. → The CD-R/RW is blank. → There is a problem with the quality of the CD-R/RW, recording device, or application software. → Files in two or more formats have been recorded on the same CD-R/RW. (page 7)
"HOLD" flashes on the display when you press a button, and the CD does not play.	→ The buttons are locked. Slide the HOLD switch back. (page 23)

(Continued)

Troubleshooting

Symptom	Cause and/or corrective actions
Playback starts from the point you stopped. (resume function)	→ The resume function is working. To start play from the first track, press ▶ during stop until the first track starts playing, or open the lid of the CD player. Or remove all power sources, then insert the batteries or connect the AC power adaptor again. (pages 11, 12, 27)
Rustling noise is heard from the CD.	→ Close the lid of the battery compartment firmly. (page 27)
When using with a connected stereo system, the sound is distorted or noisy.	→ Adjust the volume of the CD player and the connected device. (page 29)
During playback of an ATRAC CD or MP3 CD, the CD does not rotate but you can hear the sound normally.	→ The CD player is designed to stop the rotation of an ATRAC CD or MP3 CD during playback to reduce the power consumption. The player is not malfunctioning.
"NO FILE" appears in the display after ▶ is pressed or the lid of the CD player is closed.	→ There are no ATRAC3plus/ATRAC3/MP3 files in the CD. → A CD-RW from which the data has been erased is being used. → The CD is dirty.
When closing the lid of the CD player, the CD starts to rotate.	→ The CD player is reading the information on the CD. The player is not malfunctioning.
The LCD display becomes hard to see or slows down.	→ You are using your CD player at high temperatures (above 40°C/104°F) or at low temperatures (below 0°C/32°F). At room temperature, the display will return to its normal operating condition.
"  is flashing quickly in the display, and you cannot locate the beginning of the track or the specific point in the track.	→ The CD player has entered the Bookmark track play. Press P MODE/  repeatedly until "  " disappears from the display.

Specifications

System

Compact disc digital audio system

Laser diode properties

Material: GaAlAs

Wavelength: $\lambda = 780 \text{ nm}$

Emission duration: Continuous

Laser output: Less than $44.6 \mu\text{W}$

(This output is the value measured at a distance of 200 mm from the objective lens surface on the optical pick-up block with 7 mm aperture.)

D-A conversion

1-bit quartz time-axis control

Frequency response

20 - 20 000 Hz ± 1 dB (measured by JEITA CP-307)

Output (at 4.5 V input level)

Headphones (stereo minijack)

Approx. 5 mW + Approx. 5 mW at 16Ω

Power requirements

For the area code of the model you purchased, check the upper left side of the bar code on the package.

- Two LR6 (size AA) batteries: 1.5 V DC $\times 2$
- AC power adaptor (DC IN 4.5 V jack):
U, U2, CA, CA2, E92, MX2, TW2 and CA2/C models: 120 V, 60 Hz
CED, CED/4, CE7, CE7/C, EE, EE1, E, E13 and E13/2 models: 220 - 230 V, 50/60 Hz
CEK model: 230 V, 50 Hz
AU2 model: 240 V, 50 Hz
EU8, EU8/C, JE.W, E18, KR4 and EE8 models:
100 - 240 V, 50/60 Hz
HK4 model: 230 V, 50 Hz
CNA model: 220 V, 50 Hz

Battery life*1 (approx. hours)

(When you use the CD player on a flat and stable surface)

Playing time varies depending on how the CD player is used.

When using two Sony alkaline batteries LR6 (SG) (produced in Japan)

	G-PROTECTION function	
	"1"	"2"
Audio CD	50	45
ATRAC3plus files*2	80	80
MP3 files*3	75	75

*1 Measured value by the standard of JEITA (Japan Electronics and Information Technology Industries Association)

*2 When recorded at 48 kbps or 64 kbps

*3 When recorded at 128 kbps

Operating temperature

5°C - 35°C (41°F - 95°F)

Dimensions (w/h/d) (excluding projecting parts and controls)

Approx. $136.0 \times 26.3 \times 156.3 \text{ mm}$
($5 \frac{3}{8} \times 1 \frac{1}{16} \times 6 \frac{1}{4} \text{ in.}$)

Mass (excluding accessories)

Approx. 202 g (7.2 oz.)

Design and specifications are subject to change without notice.

Optional accessories

AC power adaptor	AC-E45HG
Active speaker system	SRS-Z1
Car battery cord	DCC-E345
Car battery cord with car connecting pack	DCC-E34CP
Car connecting pack	CPA-9C
Earphones	MDR-E931LP MDR-EX71SL MDR-Q55SL

Your dealer may not handle some of the accessories listed above. Please ask the dealer for detailed information about the accessories in your country.

This warranty is valid only in the United States.

SONY[®]

Portable Memory Stick Audio Player/
Portable MiniDisc Recorder/
Portable CD Player

LIMITED WARRANTY

Portable Audio

Sony Electronics Inc. ("Sony") warrants this Product (including any accessories) against defects in material or workmanship as follows:

1. **LABOR:** For a period of 90 days from the date of purchase, if this Product is determined to be defective, Sony will repair or replace the Product, at its option, at no charge, or pay the labor charges to any Sony authorized service facility. After the Warranty Period, you must pay for all labor charges.

2. **PARTS:** In addition, Sony will supply, at no charge, new or rebuilt replacements in exchange for defective parts for a period of one (1) year. After 90 days from the date of purchase, labor for removal and installation is available from Sony authorized service facilities or a Sony Service Center at your expense.

To obtain warranty service, you must take the Product, or deliver the Product freight prepaid, in either its original packaging or packaging affording an equal degree of protection, to any authorized Sony service facility.

This warranty does not cover customer instruction, installation, set up adjustments or signal reception problems.

This warranty does not cover cosmetic damage or damage due to acts of God, accident, misuse, abuse, negligence, commercial use, or modification of, or to any part of the Product, including the antenna. This warranty does not cover damage due to improper operation or maintenance, connection to improper voltage supply, or attempted repair by anyone other than a facility authorized by Sony to service the Product. This warranty does not cover Products sold AS IS or WITH ALL FAULTS, or consumables (such as fuses or batteries). This warranty is valid only in the United States.

Proof of purchase in the form of a bill of sale or receipted invoice which is evidence that the unit is within the Warranty period must be presented to obtain warranty service.

This warranty is invalid if the factory applied serial number has been altered or removed from the Product.

REPAIR OR REPLACEMENT AS PROVIDED UNDER THIS WARRANTY IS THE EXCLUSIVE REMEDY OF THE CONSUMER. SONY SHALL NOT BE LIABLE FOR ANY INCIDENTAL OR CONSEQUENTIAL DAMAGES FOR BREACH OF ANY EXPRESS OR IMPLIED WARRANTY ON THIS PRODUCT, EXCEPT TO THE EXTENT PROHIBITED BY APPLICABLE LAW. ANY IMPLIED WARRANTY OF MERCHANTABILITY OR FITNESS FOR A PARTICULAR PURPOSE ON THIS PRODUCT IS LIMITED IN DURATION TO THE DURATION OF THIS WARRANTY.

Some states do not allow the exclusion or limitation of incidental or consequential damages, or allow limitations on how long an implied warranty lasts, so the above limitations or exclusions may not apply to you. In addition, if you enter into a service contract with the Sony Partnership within 90 days of the date of sale, the limitation on how long an implied warranty lasts does not apply to you. This warranty gives you specific legal rights, and you may have other rights which vary from state to state.

For your convenience, Sony Electronics Inc. has established telephone numbers for frequently asked questions:

To locate the servicer or dealer nearest you, or for service assistance or resolution of a service problem, or for product information or operation, contact:

www.sony.com/walkmansupport

Sony Network Portable Audio Support Line
1-866-456-7669

Sony Customer Information Service Center
12451 Gateway Blvd.
Fort Myers, FL 33913

For an accessory or part not available from your authorized dealer, call:

1-800-488-SONY (7669)

D 324343302

<http://www.sony.net/>

Sony Corporation Printed in Malaysia