

# FM/AM Portable CD Player

## Operating Instructions

"WALKMAN", , and  are registered trademarks of Sony Corporation.

D-NS313F

©2006 Sony Corporation Printed in China



Printed on 100 % recycled paper using VOC (Volatile Organic Compound)-free vegetable oil based ink.

<http://www.sony.net/>

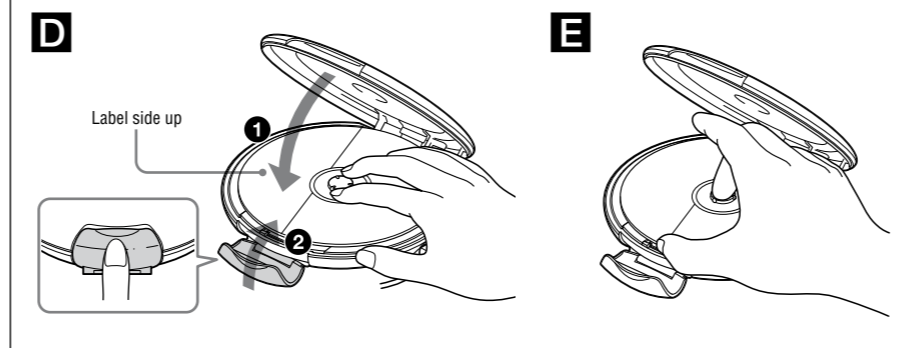

### WARNING

To reduce the risk of fire or electric shock, do not expose this apparatus to rain or moisture.

Do not install the appliance in a confined space, such as a bookcase or built-in cabinet.

To reduce the risk of fire, do not cover the ventilation of the apparatus with newspapers, tablecloths, curtains, etc. And do not place lighted candles on the apparatus.

To reduce the risk of fire or electric shock, do not place objects filled with liquids, such as vases, on the apparatus.

### CAUTION

The use of optical instruments with this product will increase eye hazard.

Certain countries may regulate disposal of the battery used to power this product. Please consult with your local authority.

The validity of the CE marking is restricted to only those countries where it is officially enforced, mainly in the countries EEA (European Economic Area).

### For customers who purchased this product in the USA

#### Owner's Record

The model number and the serial number are located at the rear of the CD player. Record the serial number in the space provided below. Refer to these numbers whenever you call upon your Sony dealer regarding this product.

Model No. D-NS313F  
Serial No. \_\_\_\_\_

#### Product registration

Please register this product on line at [www.sony.com/walkmanreg](http://www.sony.com/walkmanreg) <<http://www.sony.com/walkmanreg>>

Proper registration will enable us to send you periodic mailings about software upgrades, new products, services and other important announcements. Thank you.

**Note:** This equipment has been tested and found to comply with the limits for a Class B digital device, pursuant to Part 15 of the FCC Rules. These limits are designed to provide reasonable protection against harmful interference in a residential installation. This equipment generates, uses, and can radiate radio frequency energy and, if not installed and used in accordance with the instructions, may cause harmful interference to radio communications. However, there is no guarantee that interference will not occur in a particular installation. If this equipment does cause harmful interference to radio or television reception, which can be determined by turning the equipment off and on, the user is encouraged to try to correct the interference by one or more of the following measures:

- Reorient or relocate the receiving antenna.
- Increase the separation between the equipment and receiver.
- Connect the equipment into an outlet on a circuit different from that to which the receiver is connected.
- Consult the dealer or an experienced radio/TV technician for help.

You are cautioned that any changes or modifications not expressly approved in this manual could void your authority to operate this equipment.

### Discs Playable on this CD Player

- Audio CDs (CD-DA format CDs)
  - MP3 CDs (CD-R/CD-RW on which audio data compressed in the MP3 format has been recorded)\*
- \* Only ISO 9660 Level 1/2 and Joliet extension format discs can be played.

Bit rates and sampling frequencies this CD player can play are as follows. Variable Bit Rate (VBR) files can also be played.

	Bit rates	Sampling frequencies
MPEG-1 Layer3	32 – 320 kbps	32/44.1/48 kHz
MPEG-2 Layer3	8 – 160 kbps	16/22.05/24 kHz
MPEG-2.5 Layer3	8 – 160 kbps	8/11.025/12 kHz

#### MP3 CDs

- The usable number of groups and files
- Maximum number of groups: 256
- Maximum number of files: 512

#### Playing order

The playing order may differ depending on the method used to record MP3 files on the disc. In the following example, files are played in order of ① to ⑧.

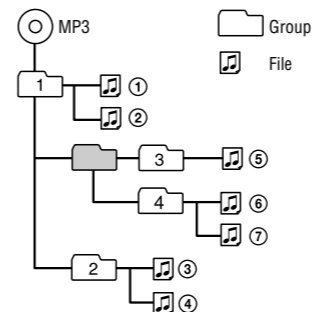

#### Notes

- Depending on the quality of the disc and/or the condition of the recording device, it may take a while for playback to start. It is also possible playback may not start at all.
- On a disc that has MP3 files, do not save files in other formats and do not make unnecessary folders.
- Be sure to add the file extension "mp3" to the file name. However, if you add the extension "mp3" to a file other than an MP3 file, the player will not be able to recognize the file properly.
- To compress a source in an MP3 file, we recommend setting the compression parameters to "44.1 kHz," "128 kbps," and "Constant Bit Rate."
- To record up to the maximum capacity, set the writing software to "halting of writing."

### Power Sources

#### To use the batteries (not supplied)

- 1 Unfasten the buckle to open the player lid and open the battery compartment lid inside the CD player (A, B).
- 2 Insert two LR6 (size AA) alkaline batteries by matching the ⊕ to the diagram inside the CD player and close the lid until it clicks into place. Insert the ⊖ end first (for both batteries) (E).

#### Battery life\* (approx. hours)

(When the CD player is used on a flat and stable place.)  
Playing time varies depending on how the CD player is used.

#### When using two Sony alkaline batteries LR6 (SG) (produced in Japan)

G-PROTECTION	G-on	G-off
Audio CD	16	11
MP3 CD (Recorded at 128 kbps)	23	23
RADIO ON	35	

\* Measured value by the standard of JEITA (Japan Electronics and Information Technology Industries Association).

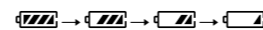

#### To check the remaining power of the batteries

You can check it in the display.  
Replace the batteries when "  " flashes.



→  → Lo batt

#### Notes

- The indicator sections of  roughly shows the remaining battery power. One section does not always indicate one-fourth of the battery power.
- Depending on operating conditions, the indicator sections of  may increase or decrease.

#### To use the AC power adaptor

Connect the AC power adaptor as illustrated (C).

### Playing a CD

- 1 Unfasten the buckle to open the lid (A).
- 2 Fit the CD to the pivot, then close the lid (D).
- 3 While holding the lid closed, fasten the buckle securely (E).
- 4 Press **▶||**.

To play from the first track, press and hold **▶||** until playback starts while the CD player is stopped.  
To jump to the succeeding/previous groups\*, press GROUP first, then press **◀** or **▶**.  
\*MP3 CD only

- This CD player can play CD-Rs/CD-RWs recorded in the Compact Disc Digital Audio (Audio CD) format, but playback capability may vary depending on the quality of the disc and the condition of the recording device.
- This product is designed to play back discs that conform to the Compact Disc (CD) standard. Recently, various music discs encoded with copyright protection technologies are marketed by some record companies. Please be aware that among those discs, there are some that do not conform to the CD standard and may not be playable by this product.
- Depending on the CD, this player may display a total number of files that includes both playable and unplayable files. However, because the player skips unplayable files automatically, only the playable ones will be played.

#### Note on DualDiscs

A DualDisc is a two sided disc product which mates DVD recorded material on one side with digital audio material on the other side. However, since the audio material side does not conform to the Compact Disc (CD) standard, playback on this product is not guaranteed.

#### Digital MEGA BASS function

During play, press SOUND/AVLS repeatedly to select "SND 1" or "SND 2."  
If the sound is distorted, turn down the volume.

While listening to the radio, this function is disabled.

#### AVLS\* function

##### \*Automatic Volume Limiter System

Press and hold SOUND/AVLS.  
If "AVLS" flashes three times, the function is enabled.  
If "AVLS" flashes once, the function is disabled.

You can also use this function while listening to the radio.

#### AMS\* / search function

##### \*Automatic Music Sensor

To find the beginning of the previous/current/next/succeeding track(s): Press **◀**/**▶** repeatedly.  
To go backward/forward quickly: Press and hold **◀**/**▶**.

#### Play mode function

During play, press P MODE/↵ repeatedly:  
No indication (normal play) →  (group play)\* → "1" (single track play) → "SHUF" (shuffle play)  
To repeat the play mode you selected, press and hold P MODE/↵ until "↵" appears.

\* All files in the selected group are played once. MP3 CD only.

#### G-PROTECTION function

The function provides protection against sound skipping during many active uses.\*  
The default setting is "G-on." To select "G-off," press **▶||** while you keep pressing **▶||** during stop. To enjoy high quality CD sound, select "G-off".

\* Sound may skip: if the CD player receives stronger continuous shock than expected / if a dirty or scratched CD is played / when using poor-quality CD-Rs/CD-RWs or if there is a problem with the recording device or application software.

#### To remove the CD

Remove the CD while pressing the pivot (E).

### Listening to the Radio

- 1 Press RADIO ON/BAND to turn on the radio.  
If "PRESET" appears on the display, press P MODE/↵ to make "PRESET" disappear from the display.
- 2 Press RADIO ON/BAND until the band you want appears.

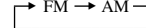
Each time you press the button, the display changes as follows:  

- 3 Press TUNE + or – to tune in the station you want and adjust the volume.

#### Turning off the radio

Press **■** • RADIO OFF.

#### Tuning in the station quickly

Press and hold TUNE + or – in step 3 until the frequency digits begin to change on the display. The CD player automatically scans the radio frequencies and stops when it finds a clear station.

#### Improving broadcast reception

For FM, extend the headphones cord.

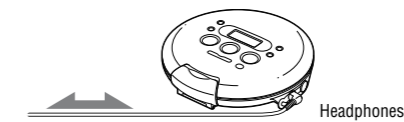

For AM, reorient the CD player itself.

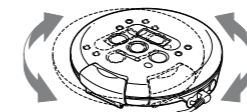

#### Note

Keep the headphones connected to the ⊕ jack of the CD player. The headphones cord works as the FM antenna.

#### If it is hard to hear the FM broadcast due to interference from strong radio waves

- 1 While listening to the FM broadcast, press SOUND/AVLS. "LOCAL" flashes.
- 2 Press **▶||**/ENTER within 10 seconds after you finished the previous operation.\*  
"LOCAL" stops flashing.  
\* If "LOCAL" disappears from the display, start from Step 1.

To cancel the LOCAL setting, press SOUND/AVLS, and then press **▶||**/ENTER so that "LOCAL" disappears from the display.

#### If it is hard to hear the FM broadcast due to poor reception

- 1 While listening to the FM broadcast, press SOUND/AVLS. "LOCAL" flashes.
- 2 Press SOUND/AVLS again.  
"MONO" flashes.
- 3 Press **▶||**/ENTER within 10 seconds after you finished the previous operation.\*  
"MONO" stops flashing.  
\* If "MONO" disappears from the display, start from Step 1.

To cancel the MONO setting, press SOUND/AVLS twice, and then press **▶||**/ENTER so that "MONO" disappears from the display.

### Presetting Radio Stations

You can preset up to 30 stations: 20 for FM and 10 for AM.

- 1 While listening to the radio, press P MODE/↵ to enter the preset mode.  
"PRESET" appears on the display.
- 2 Press TUNE + or – repeatedly until the preset number you want appears on the display.
- 3 Press and hold P MODE/↵ until "PRESET" flashes on the display.  
From this step on, start the next operation within 30 seconds after you finished the previous operation. If "PRESET" stops flashing, start from step 3.
- 4 Press TUNE + or – repeatedly to tune in the station you want.
- 5 Press **▶||**/ENTER.

#### To cancel all preset stations

- 1 While the radio is turned off and CD play is stopped, press RADIO ON/BAND while you are pressing **▶||**.  
"CLEAR" flashes.
- 2 Press **▶||**/ENTER.

### Playing Preset Radio Stations

- 1 Press RADIO ON/BAND to select the band.
- 2 When "PRESET" does not appear on the display, press P MODE/↵ to enter the preset mode.  
"PRESET" appears on the display.
- 3 Press TUNE + or – to tune in a stored station.

### Changing the Tuning Interval

When using the CD player abroad, change the AM tuning interval, if necessary.

9 kHz area: Asia and Europe  
10 kHz area: the U.S.A., Canada and Latin America

- 1 While the radio is turned off and CD play is stopped, press P MODE/↵ while you are pressing **▶||**.  
If the current setting is "9 kHz," "10 kHz" flashes on the display.

If the current setting is "10 kHz," "9 kHz" flashes on the display.

- 2 Press **▶||**/ENTER.

After changing the tuning interval, you need to preset radio stations again.

### Wearing the supplied headphones

The following procedures are for wearing on the left ear.

- 1 Hook the L part over your left ear and the R part over your right ear as illustrated.



- 2 Hook the headphones around your ears, as you would with glasses.
- 3 Adjust the earpieces to comfortably fit your ears.

#### Notes on handling the supplied headphones

- Avoid rough handling or mechanical shock. Be particularly careful of the headphone part.
- Do not put force or weight on the unit for a long time as that may damage or deform the unit.
- Do not leave the unit in a location subject to moisture, dust, smoke, steam or direct sunlight.
- Clean the plug with a soft dry cloth. A dirty plug may cause the sound quality to deteriorate.
- Clean the headphone part with a soft dry cloth.
- After you use the headphones, keep them with the cord slider positioned high to avoid entangling the cord.

### Using the hand strap

During active uses, use the supplied hand strap.

- 1 Pass the end of the strap through the hole.

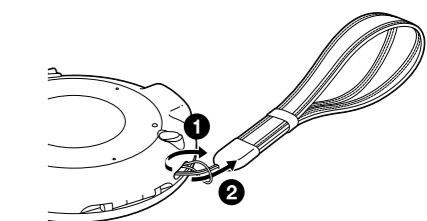

- 2 Put your hand through the strap, then adjust the length of the strap.

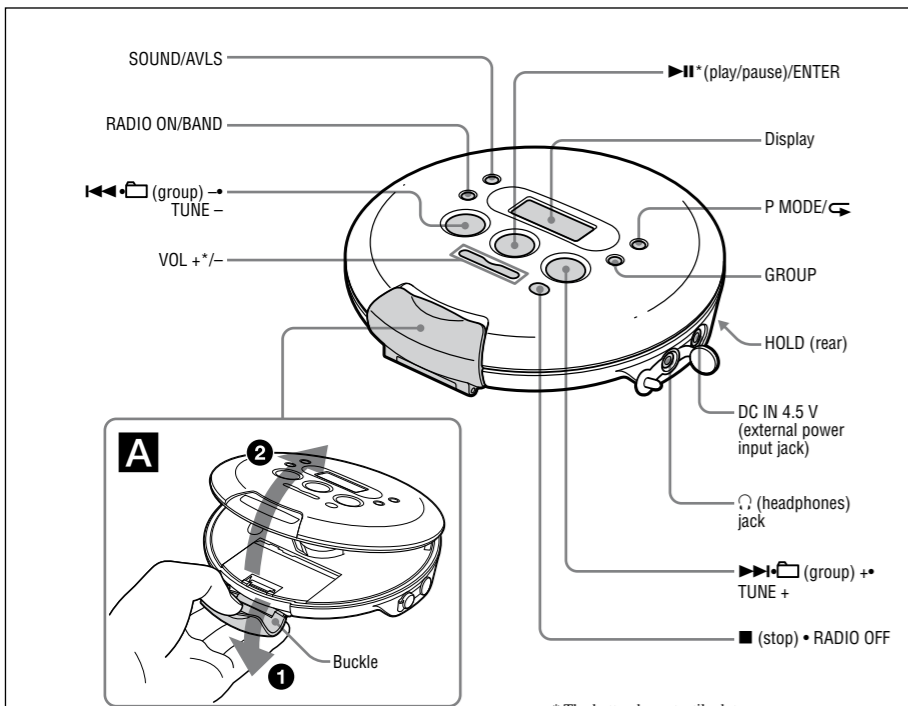
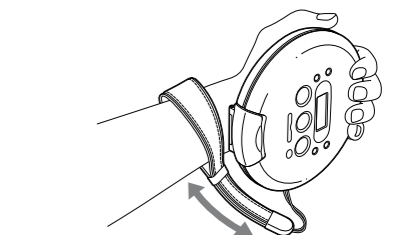

\* The button has a tactile dot.

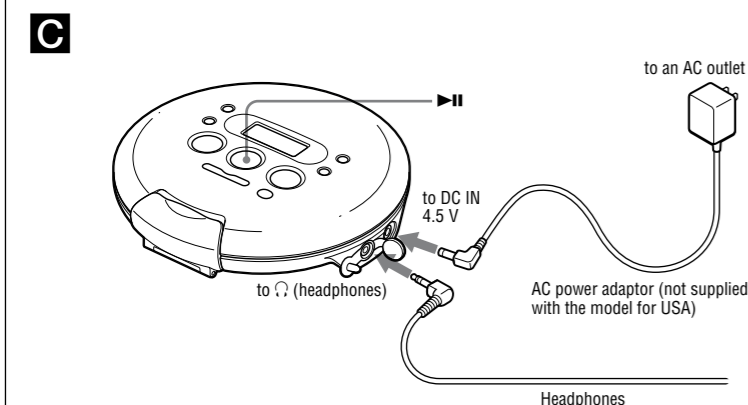
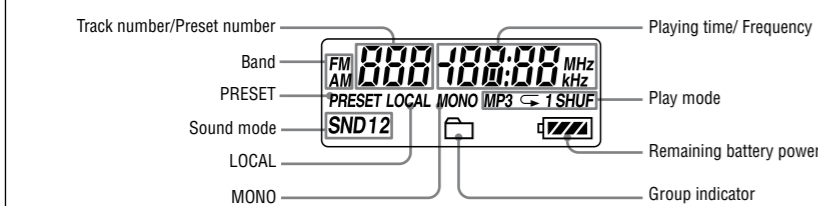
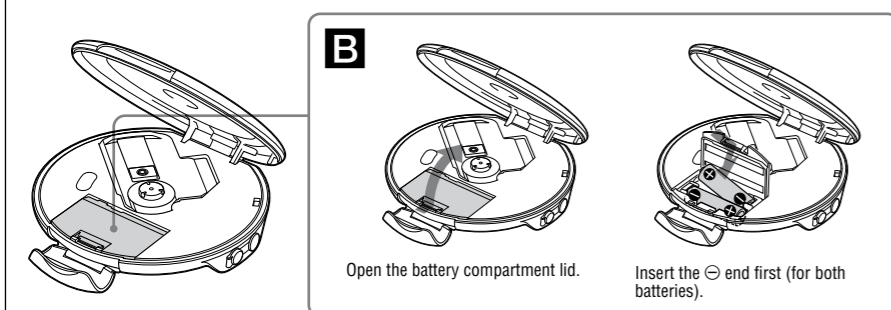

## Precautions

### On safety

- Should any solid objects or liquid fall into the CD player, unplug it and have it checked by qualified personnel before operating it any further.
- Do not put any foreign objects in the DC IN 4.5 V (external power input) jack.

### On power sources

- When you are not using the CD player for a long time, disconnect all power sources from the CD player.

### On the AC power adaptor

- Use only the AC power adaptor supplied. If your player is not supplied with an AC power adaptor, use an AC-E45HG AC power adaptor\*. Do not use any other AC power adaptor. It may cause a malfunction.

- \* Not available in Australia and some other regions. Ask your dealer for detailed information.
- Do not touch the AC power adaptor with wet hands.
- Connect the AC power adaptor to an easily accessible AC outlet. Should you notice an abnormality in the AC power adaptor, disconnect it from the AC outlet immediately.

### On dry batteries

- Do not throw the batteries into fire.
- Do not carry the batteries with coins or other metallic objects. It can generate heat if the positive and negative terminals of the battery are accidentally contacted by a metallic object.
- Do not mix new batteries with old ones.
- Do not use different types of batteries together.
- When the batteries are not to be used for a long time, remove them.
- If battery leakage occurs, wipe off any deposit in the battery compartment, and install new batteries. In case the deposit adheres to you, wash it off thoroughly.

### On the CD player

- Keep the lens on the CD player clean and do not touch it. If you do so, the lens may be damaged and the CD player will not operate properly.
- Do not put any heavy object on top of the CD player. The CD player and the CD may be damaged.
- Do not leave the CD player in a location near heat sources, or in a place subject to direct sunlight, excessive dust or sand, moisture, rain, mechanical shock, unlevelled surface, or in a car with its windows closed.
- If the CD player causes interference to the radio or television reception, turn off the CD player or move it away from the radio or television.
- Discs with non-standard shapes (e.g., heart, square, star) cannot be played on this CD player. Attempting to do so may damage the CD player. Do not use such discs.

### On headphones/earphones

### Road safety

Do not use headphones while driving, cycling, or operating any motorized vehicle. It may create a traffic hazard and is illegal in some areas. It can also be potentially dangerous to play your headphones at high volume while walking, especially at pedestrian crossings. You should exercise extreme caution or discontinue use in potentially hazardous situations.

### Preventing hearing damage

Avoid using headphones at high volume. Hearing experts advise against continuous, loud and extended play. If you experience a ringing in your ears, reduce volume or discontinue use.

### Consideration for others

Keep the volume at a moderate level. This will allow you to hear outside sounds and to be considerate to the people around you.

### On the water resistance

- Before unfastening the buckle to open the lid, be sure to wipe off water, dust or sand on the exterior of the unit. Open and close the lid where water or sand cannot fall in the unit, and make sure that your hands are dry. If water or sand falls in the unit, trouble may occur.
- When closing the lid, check that there is no dust or sand on the rubber packing around the lid. Then close the lid firmly with the buckle.
- The supplied headphones are not meant to be immersed in water or come in continuous contact with water. If they are accidentally dropped into water or get wet, dry them with a soft cloth. Never use an electric hair dryer.
- The AC power adaptor is not water resistant. To prevent shock hazard, avoid using the player near water during AC operation.
- Cover the DC IN 4.5 V jack and ↕ jack with the attached rubber caps when nothing is connected to these jacks. If the inside of the jacks are contaminated with water or sand, rust may develop and cause trouble.

### Notes

- Since the unit is airtight, you may not be able to open the lid when there is a sudden change in air pressure inside the unit. This happens when the unit is transported on a plane or moved from a warm place to a cold place. In this case, open the rubber cap on the DC IN 4.5 V jack.
- To prevent water from leaking in, the buckle is designed to be slightly stiff. Be careful not to catch a fingernail on the buckle when unfastening the lid.

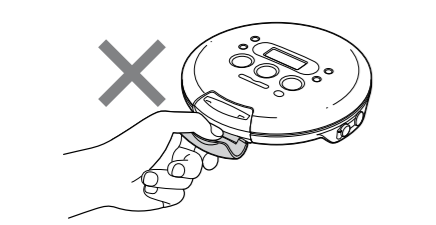

Do not hold the player with the buckle by itself. Doing so may damage the unit.

## Maintenance

### To clean the casing

Use a soft cloth slightly moistened in water or a mild detergent solution. Do not use alcohol, benzine or thinner.

### To clean the headphones plug

Keep the plug of your headphones clean to obtain optimum sound. Wipe it with a dry, soft cloth.

### To remove any dust or sand from the rubber packing

Any sand or dust on the rubber packing will prevent the lid from shutting tightly, and water may leak in. Brush off the dust once in a while.

We recommend the replacement of the rubber packing every year which is available optionally at an authorized Sony service facility.

### To clean the strap

Wipe the strap with a soft cloth moistened in water. Do not wash it.

## Troubleshooting

Should any problem persist after you have made these checks, consult your nearest Sony dealer.

**“Hold” appears in the display when you press a button, and the CD does not play.**

→ The buttons are locked. Slide HOLD back.

**The volume does not increase even if you press VOL + repeatedly.**

→ Press and hold SOUND/AVLS until “AVLS” flashes once so that you can cancel the AVLS function.

**The CD player does not operate properly.**

→ Moisture condensation has occurred. Leave the player aside for several hours until the moisture evaporates.

**Even though the file number is displayed, the player skips the file and does not play it.**

→ A file with a format that is unplayable on this player is recorded on the CD.

**The battery compartment lid is detached by an accidental drop, excessive force, etc.**

→ Attach it as illustrated below.

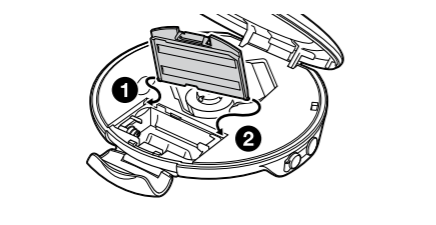

## Specifications

### CD player

**System:** Compact disc digital audio system

**Laser diode properties:**

Emission duration: Continuous

Laser output: Less than 44.6 μW (This output is the value measured at a distance of 200 mm from the objective lens surface on the optical pick-up block with 7 mm aperture.)

### Radio

**Frequency range**

9 kHz step:

FM: 87.5 - 108 MHz

AM: 531 - 1 710 kHz

10 kHz step:

FM: 87.5 - 108 MHz

AM: 530 - 1 710 kHz

**Antennas**

FM: Headphones cord antenna

AM: Built-in ferrite bar antenna

### General

**Power requirements:**

- Two LR6 (size AA) batteries: 1.5 V DC × 2
- AC power adaptor (DC IN 4.5 V jack): 120 V, 60 Hz

**Dimensions (w/h/d) (without projecting parts and controls):**

Approx. 142 × 34 × 143.9 mm (5 <sup>5</sup>/<sub>8</sub> × 1 <sup>3</sup>/<sub>8</sub> × 5 <sup>3</sup>/<sub>4</sub> in.)

**Mass (excluding accessories):**

Approx. 310 g (11.0 oz.)

**Operating temperature:** 5°C - 35°C (41°F - 95°F)

MPEG Layer-3 audio coding technology and patents licensed from Fraunhofer IIS and Thomson.

Design and specifications are subject to change without notice.

### Supplied accessories

AC power adaptor (1) (not supplied with the model for USA)

Headphones (1)

Hand strap (1)

This warranty is valid only in the United States.

<p><b>SONY</b><sup>®</sup></p> <p>Tape Cassette Player/Recorder/CD Player/Mini Disc DAT/Radio/Head Phone/Speaker/MIC/Personals</p> <p><b>Portable Audio</b></p> <h1 style="text-align: center;">LIMITED WARRANTY</h1> <p>Sony Electronics Inc. (“Sony”) warrants this Product (including any accessories) against defects in material or workmanship as follows:</p> <ol style="list-style-type: none"> <li>LABOR: For a period of 90 days from the date of purchase, if this Product is determined to be defective, Sony will repair or replace the Product, at its option, at no charge, or pay the labor charges to any Sony authorized service facility. After the Warranty Period, you must pay for all labor charges.</li> <li>PARTS: In addition, Sony will supply, at no charge, new or rebuilt replacements in exchange for defective parts for a period of one (1) year. After 90 days from the date of purchase, labor for removal and installation is available from Sony authorized service facilities or a Sony Service Center at your expense.</li> </ol> <p>To obtain warranty service, you must take the Product, or deliver the Product freight prepaid, in either its original packaging or packaging affording an equal degree of protection, to any authorized Sony service facility.</p> <p>This warranty does not cover customer instruction, installation, set up adjustments or signal reception problems.</p> <p>This warranty does not cover cosmetic damage or damage due to acts of God, accident, misuse, abuse, negligence, commercial use, or modification of, or to any part of the Product, including the antenna. This warranty does not cover damage due to improper operation or maintenance, connection to improper voltage supply, or attempted repair by anyone other than a facility authorized by Sony to service the Product. This warranty does not cover Products sold AS IS or WITH ALL FAULTS, or consumables (such as fuses or batteries). This warranty is valid only in the United States.</p> <p>Proof of purchase in the form of a bill of sale or receipted invoice which is evidence that the unit is within the Warranty period must be presented to obtain warranty service.</p> <p>This warranty is invalid if the factory applied serial number has been altered or removed from the Product.</p> <hr/> <p>REPAIR OR REPLACEMENT AS PROVIDED UNDER THIS WARRANTY IS THE EXCLUSIVE REMEDY OF THE CONSUMER. SONY SHALL NOT BE LIABLE FOR ANY INCIDENTAL OR CONSEQUENTIAL DAMAGES FOR BREACH OF ANY EXPRESS OR IMPLIED WARRANTY ON THIS PRODUCT. EXCEPT TO THE EXTENT PROHIBITED BY APPLICABLE LAW, ANY IMPLIED WARRANTY OF MERCHANTABILITY OR FITNESS FOR A PARTICULAR PURPOSE ON THIS PRODUCT IS LIMITED IN DURATION TO THE DURATION OF THIS WARRANTY.</p> <hr/> <p>Some states do not allow the exclusion or limitation of incidental or consequential damages, or allow limitations on how long an implied warranty lasts, so the above limitations or exclusions may not apply to you. In addition, if you enter into a service contract with the Sony Partnership within 90 days of the date of sale, the limitation on how long an implied warranty lasts does not apply to you. This warranty gives you specific legal rights, and you may have other rights which vary from state to state.</p> <p>For your convenience, Sony Electronics Inc. has established telephone numbers for frequently asked questions:</p> <p>To locate the servicer or dealer nearest you, or for service assistance or resolution of a service problem, or for product information or operation, call:</p> <p style="text-align: center;"><b>Sony Customer Information Services Center</b> 1-800-222-7669 or visit the Sony Web Site: www.sony.com</p> <p>For an accessory or part not available from your authorized dealer, call:</p> <p style="text-align: center;">1-800-488-SONY (7669)</p>	<p>D 455714702</p>
--------------------------------------------------------------------------------------------------------------------------------------------------------------------------------------------------------------------------------------------------------------------------------------------------------------------------------------------------------------------------------------------------------------------------------------------------------------------------------------------------------------------------------------------------------------------------------------------------------------------------------------------------------------------------------------------------------------------------------------------------------------------------------------------------------------------------------------------------------------------------------------------------------------------------------------------------------------------------------------------------------------------------------------------------------------------------------------------------------------------------------------------------------------------------------------------------------------------------------------------------------------------------------------------------------------------------------------------------------------------------------------------------------------------------------------------------------------------------------------------------------------------------------------------------------------------------------------------------------------------------------------------------------------------------------------------------------------------------------------------------------------------------------------------------------------------------------------------------------------------------------------------------------------------------------------------------------------------------------------------------------------------------------------------------------------------------------------------------------------------------------------------------------------------------------------------------------------------------------------------------------------------------------------------------------------------------------------------------------------------------------------------------------------------------------------------------------------------------------------------------------------------------------------------------------------------------------------------------------------------------------------------------------------------------------------------------------------------------------------------------------------------------------------------------------------------------------------------------------------------------------------------------------------------------------------------------------------------------------------------------------------------------------------------------------------------------------------------------------------------------------------------------------------------------------------------------------------------------------------------------------------------------------------------------------------------------------------------------------------------------------------------------------------------------------------------------------------------------------------------------------------------------------------------------------------------------------------------------------------------------------------------------------------------------------------------------------------------------------------------------------------------------------------------------------------------------------------------------------------------------------------------------------------------------------------------------------------	--------------------