

Digital Audio Receiver

Operating Instructions

Before operating the unit, install the unit correctly by referring to the Installation Guide. You need to subscribe for XM™ Satellite Radio Service to listen to the radio broadcast.

OWNER'S RECORD

The model number is located on the bottom and serial number also on the bottom. Record the serial number in the space provide below. Refer to these numbers whenever you call upon your Sony dealer regarding this product.

Model No. _____

Serial No. _____

Radio ID _____

DRN-XM01C2
DRN-XM01R2
DRN-XM01H2

Sony Corporation ©2002 Printed in Japan
<http://www.sony.net/>



Printed on 100% recycled paper using VOC (Volatile Organic Compound)-free vegetable oil based ink.

For customers in the USA

Please register this product on line at <http://www.sony.com/productregistration>. Proper registration will enable us to send you periodic mailings about new products, services, and other important announcements. Registering your product will also allow us to contact you in the unlikely event that the product needs adjustment or modification. Thank you.

WARNING

To prevent fire or shock hazard, do not expose the unit to rain or moisture.

To avoid electrical shock, do not open the cabinet. Refer servicing to qualified personnel only.

You are cautioned that any changes or modifications not expressly approved in this manual could void your authority to operate this equipment.

INFORMATION

This equipment has been tested and found to comply with the limits for a Class B digital device, pursuant to Part 15 of the FCC Rules. These limits are designed to provide reasonable protection against harmful interference in a residential installation. This equipment generates, uses, and can radiate radio frequency energy and, if not installed and used in accordance with the instructions, may cause harmful interference to radio communications. However, there is no guarantee that interference will not occur in a particular installation. If this equipment does cause harmful interference to radio or television reception, which can be determined by turning the equipment off and on, the user is encouraged to try to correct the interference by one or more of the following measures:

- Reorient or relocate the receiving antenna.
- Increase the separation between the equipment and receiver.
- Connect the equipment into an outlet on a circuit different from that to which the receiver is connected.
- Consult the dealer or an experienced radio/TV technician for help.

This device complies with Part 15 of the FCC Rules. Operation is subject to the following two conditions: (1) This device may not cause harmful interference, and (2) this device must accept any interference received, including interference that may cause undesired operation.

Caution

- Do not operate the unit in a way that might divert your attention from driving safely. As a driver, you alone are responsible for safely operating your vehicle in accordance with traffic safety laws at all times.
- Do not install the unit where it may obstruct your view through the windshield or your view of your vehicle's indicator displays.
- Do not install the unit where it may hinder the function of safety devices such as an air-bag. Doing so may prevent the air-bag from functioning properly in the event of an accident.
- The installation and use suggestions contained in this manual are subject to any restrictions or limitations that may be imposed by applicable law— purchaser should check applicable law for any restrictions or limitations before installing and/or operating this product.
- Failure to follow these safety instructions and warnings may result in a serious accident.

Before You Begin

Thank you for choosing the Sony digital audio receiver! It will give you many hours of reliable service and listening pleasure. Before operating the receiver, please read these instructions thoroughly and retain them for future reference.

If you have any questions about this product, you may call: Sony Direct Response Center 1-(800)-222-7669 or write to: Sony Direct Response Center 12451 Gateway Blvd. Fort Myers, FL 33913

Declaration of Conformity	
Trade Name:	SONY
Model:	DRN-XM01MK2
Responsible Party:	Sony Electronics Inc.
Address:	680 Kinderkamack Road, Oradell, NJ 07649 USA
Telephone Number:	201-930-6972
<p>This device complies with Part 15 of the FCC Rules. Operation is subject to the following two conditions: (1) This device may not cause harmful interference, and (2) this device must accept any interference received, including interference that may cause undesired operation.</p>	

If you have any questions or problem concerning this product, consult your nearest Sony dealer: 1-(866)-473-7669. If you have any questions or problem concerning the XM Satellite radio service including the broadcast, consult XM. The Radio ID is required when consulting XM. It is located on the bottom of the main unit, and you can also check it in the display of this unit (see "Displaying the Radio ID").

Introducing XM™ Satellite Radio

There's a world beyond AM and FM. XM Satellite Radio. Up to 100 channels. Coast-to-Coast Coverage. Digital quality sound. With many commercial-free music channels. Plus, the best sports, comedy, talk, news and entertainment, including USA Today, Discovery Radio, NASCAR, Sesame Workshop, CNNfn and CNN/SI. Questions? Visit www.xmradio.com. The future is waiting.

How to Subscribe

Listeners can subscribe by visiting XM on the Web at www.xmradio.com or by calling XM's Listener Care at (800)852-9696. Customers should have their Radio ID ready; it is located on the bottom of the main unit, and you can also check it in the display of this unit (see "Displaying the Radio ID").

Technology. It is prohibited to copy, decompile, disassemble, reverse engineer or manipulate any technology incorporated in receivers compatible with the XM Satellite Radio system. Furthermore, the AMBE® voice compression software included in this product is protected by intellectual property rights including patent rights, copyrights, and trade secrets of Digital Voice Systems, Inc. The user of this or any other software contained in an XM Radio is explicitly prohibited from attempting to copy, decompile, reverse engineer, or disassemble the object code, or in any other way convert the object code into human-readable form. The software is licensed solely for use within this product.

Features

- This unit is exclusively for the XM Satellite radio.
- Display function for a variety of text information about the tuned-in channel.
- Memo function enables the unit to store the text information for up to 10 memories.
- Preset function for up to 20 channels.
- Direct selection of the desired channel with the remote commander.
- Transportable type receiver, which can be attached and removed from the cradle easily.
- Jog roller and remote commander for easy operation.
- Category Scroll function using a specified category for easy channel selection.
- Auto Power Down function enables the unit to automatically turn power off.

Precautions

For customers who use this unit in a car

- When you turn off the ignition switch of your car, be sure to turn off the power of the unit by pressing the POWER button on the main unit or remote commander. Otherwise the unit may drain car battery.
- When you get out of your car, remove the main unit from the cradle and take it with you to prevent it from being stolen.

Troubleshooting

Should any problem persist after you have made the following checks, consult your nearest Sony dealer. Consult XM if you have any questions or problem concerning the broadcast service of the XM Satellite radio.

The unit cannot receive channels at all.

- When "CHECK ANTENNA" appears in the display
 - The supplied antenna is not connected to this unit. Check the connection of the antenna cord, then turn the power on again.
- When "NO SIGNAL" appears in the display
 - The receiving condition is not good. Move to the place where the condition is good.

The unit cannot receive a particular channel.

- You need to subscribe for XM.
- When "UPDATING" appears in the display
 - You have not subscribed for XM or the channel is not authorized. You need to subscribe for XM.
- When "OFF AIR" appears in the display
 - The channel is not broadcasted now.
- When "CH---" appears in the display
 - The channel to be tuned-in is void due to the change by the broadcast service, a bad receiving condition, or a wrong selection of the channel that is not exist.

You cannot select a desired channel.

- In Category Scroll mode, you can select only the channels that correspond to the Channel Category you selected in the menu. Select a different Channel Category or change to the Channel Scroll mode. See "Using the Category Scrolls".

"SYSTEM ERROR" appears in the display and you cannot operate the unit.

- A system error occurs. Consult the Sony Direct Response Center.

"-----" is displayed for the text information about Artist Name/ Feature, Song/Program Title, Additional Information, or time information.

- There is no text information or time information in the channel. This is not an error.
- The text information may not be displayed depending on the unit condition, for example, right after the unit has received a channel.

When selecting a channel, or if "LOADING" appears in the display while selecting a channel, JOG roller, \uparrow/\downarrow and preset buttons may not work.

- You cannot select a channel until the unit finishes receiving the entire audio data or text information.

The unit automatically turns power off.

- The Auto Power Down is functioning. This turns off the unit automatically when no operation is performed for the specified time. To change the setting, see "Using Other Functions".

Sound distortion occurs.

- When using the unit with the car connecting pack or RF modulator, sound distortion may occur. Adjust the Line Out Level. See "Using Other Functions".

The sound is low.

- Adjust the Line Out Level to the maximum level. See "Using Other Functions".

Display is dim, or no indication is displayed.

- The unit is being used in extremely high or low temperatures or in a place with excessive moisture.

The remote commander does not function.

- Remove any obstacles between the remote commander and the unit.
- Use the remote commander near the unit.
- Point the remote commander at the remote sensor  on the unit.
- Replace battery in the remote commander with new one if it is weak.

Icon List

The following icons appear in the display.

	indicates the Channel Number, and the Band Number for the Preset Channels in number 1 to 4.
	indicates the Channel Name.
	indicates the Artist Name/Feature.
	indicates the Song/Program Title.
	indicates the Additional Information.
	indicates Time and Date.
	indicates the Category.
	indicates the Menu display.

Specifications

Main unit

Time display: 12-hour system
Auto power down function: OFF/60 min./120 min./180 min
Output: LINE OUT jack (ø 3.5 mm stereo minijack)
Power requirements: 6 V DC, DC IN 6V jack

Dimensions:

Incl. projecting parts and controls:
Approx. 105 × 40 × 120 mm (w/h/d)
(Approx. 4 1/4 × 1 3/8 × 4 3/4 inches)

When the main unit is installed in the car cradle with the car stand:

Approx. 105 × 68 × 128 mm (w/h/d) (Approx. 4 1/4 × 2 3/4 × 5 1/4 inches)

When the main unit is installed in the home cradle with the home stand:

Approx. 105 × 55 × 128 mm (w/h/d) (Approx. 4 1/4 × 2 1/4 × 5 1/8 inches)

Not incl. projecting parts and controls:

Approx. 102 × 38 × 120 mm (w/h/d)
(Approx. 4 1/8 × 1 1/2 × 4 3/4 inches)

When the main unit is installed in the car cradle with the car stand:

Approx. 102 × 66 × 128 mm (w/h/d)

(Approx. 4 1/8 × 2 3/8 × 5 1/8 inches)

When the main unit is installed in the home cradle with the home stand:

Approx. 102 × 53 × 128 mm (w/h/d)

(Approx. 4 1/8 × 2 1/8 × 5 1/8 inches)

Mass: Approx. 220 g (7.8 oz)

When the main unit is installed in the car cradle with the car stand:

Approx. 380 g (13.4 oz)

When the main unit is installed in the home cradle with the home stand:

Approx. 300 g (10.6 oz)

Remote commander

Power requirements: 3V DC, one CR2025 lithium battery

Dimensions: Approx. 47 × 125 × 9 mm (w/h/d)

(Approx. 1 7/8 × 5 × 3/8 inches) incl. projecting parts and controls

Mass: Approx. 27 g (0.95 oz) incl. lithium battery

XM antenna (supplied only for DRN-XM01H2)

Frequency: 2 332.5 - 2 345.0 MHz

Input voltage: 4.7 V DC (3.6 - 5.5 V allowable)

Current draw: 100 mA max.

Cable length: Approx. 7 m (23 ft)

Dimensions: Approx. 55 × 31 × 69 mm (w/h/d)

(Approx. 2 1/4 × 1 1/4 × 2 3/4 inches)

Mass: Approx. 250 g (8.8 oz)

Design and specifications are subject to change without notice.

Installing the Main Unit in the Cradle

Insert the main unit completely into the cradle until the main unit is locked in the cradle.

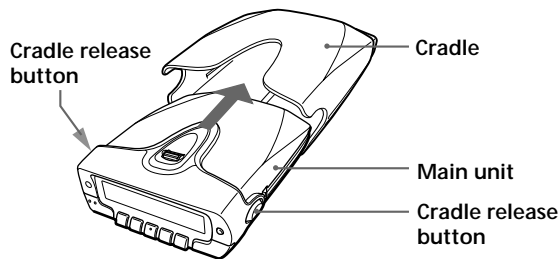

To remove the main unit from the cradle

While pressing the two cradle release buttons on the left and right sides of the main unit, pull out the main unit from the cradle.

Replacing the Lithium Battery into the Remote Commander

Replace the battery when the buttons on the remote commander do not work. Remove the old battery and insert a new one.

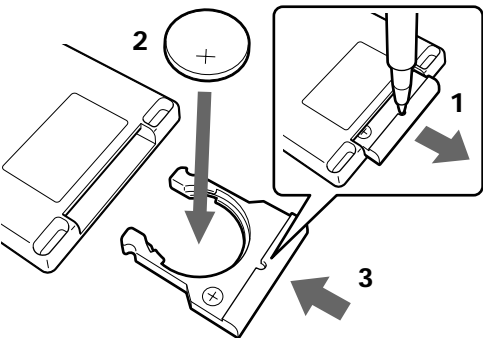

- 1** Insert a long and thin object into the hole, then pull out the lithium battery holder.
- 2** Replace the lithium battery with the positive (+) side facing up.
- 3** Insert the battery holder into the remote commander until it clicks.

Battery life

Sony lithium battery CR2025	(Approx.) 1 year
-----------------------------	---------------------

Notes on lithium battery

- Keep the lithium battery out of reach of children. Should the battery be swallowed, immediately consult a doctor.
- Wipe the battery with a dry cloth to assure good contact.
- Be sure to install the battery in the correct polarity position.
- Do not hold the battery with metallic tweezers, as doing so may cause a short-circuit.
- Do not break up the battery or throw it into a fire, which might cause it to explode.
- Carefully dispose of the used battery.

Note

When the unit is not to be used for a long period of time, remove the battery to avoid damage from battery leakage and corrosion.

Parts and Identifications

Main unit

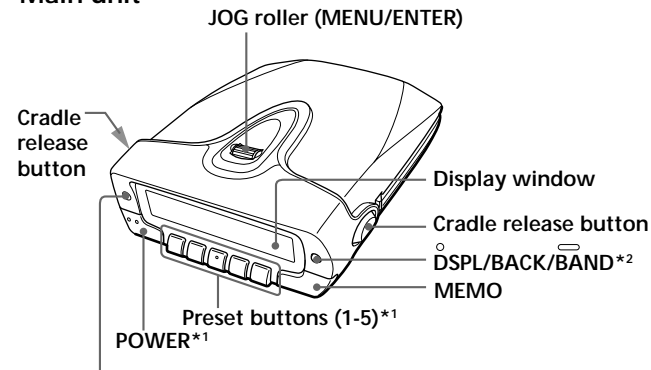

Remote sensor

Remote commander

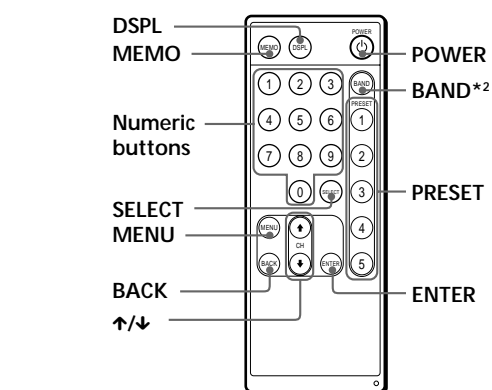

*1 The POWER and preset button No. 3 on the main unit have a tactile dot.

*2 To show the display for selecting a band, hold down DSPL/BACK/BAND for more than 2 seconds, or press BAND on the remote. To select a band, press DSPL/BACK/BAND (or BAND on the remote).

Using the JOG Roller (MENU/ENTER)

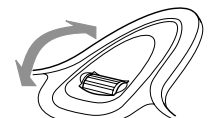

Turn up or down to select channels, select the menu items and settings, or scroll the stored text information in the menu operation.

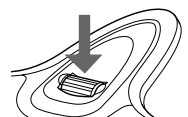

Press to display the menu display, or execute the items or settings in the menu operation.

Displaying the Radio ID

The receiver has its own ID, and an ID number is required when registering in XM.

- Press **POWER** to turn on the main unit.
- Turn **JOG roller** (or press **↑/↓** on the remote) to select “**XM1**CH0 RADIO ID”.

The radio ID appears.

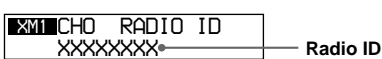

Note
The Radio ID can be displayed only in Channel Scroll mode. See “Playing the Receiver”.

Adjusting the Time Difference

This unit displays the current time by correcting the time difference between the local time and UTC (coordinated universal time) data being transmitted. Set the “hour” of your local time in the menu display. The factory-set is the eastern standard time. If the current UTC data is not received, “---:--” appears in the display.

- Press **POWER** to turn on the main unit.
- Press **JOG roller** (or **MENU** on the remote) to show the menu display. The first menu item appears.

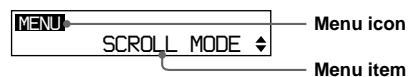

- Turn **JOG roller** (or press **↑/↓** on the remote) to select “TIME ADJUST” and press **JOG roller** (or **ENTER** on the remote). The “hour” flashes.

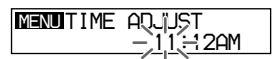

12:00 AM = midnight
12:00 PM = noon

- Turn **JOG roller** (or press **↑/↓** on the remote) to adjust the hour and press **JOG roller** (or **ENTER** on the remote). The display returns to the tuned channel display.

Note

This unit does not have the Daylight Saving Time (summer time) function.

To check the current time while listening to a broadcast Press **DSPL/BACK/BAND** (or **DSPL** on the remote) until the “**INFO**” and “**TIME**” display appears. See “Checking the Tuned Channel Information”.

To cancel a selection

Press **DSPL/BACK/BAND** (or **BACK** on the remote) to return to the previous display during menu operation. Press **MENU** on the remote commander to exit the menu display. The display returns to the tuned channel display.

Playing the Receiver

Notes

- Turn down the volume of the component connected to the unit before playing the unit.
- Adjust the volume of the component connected to the unit.
- If sound distortion occurs when playing the unit with the car connecting pack or RF modulator, adjust the Line Out Level. See “Using Other Functions”.

Manual Tuning

- Make settings on your car audio or amplifier, etc. so that you can listen to the sound from this unit.
- Press **POWER** to turn on the main unit. The channel that you last tuned in to is displayed.

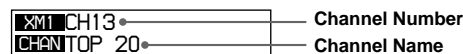

- Turn **JOG roller** (or press **↑/↓** on the remote) to select desired channel.

- Holding down **↑/↓** makes the channel readout to rapidly increase or decrease respectively.
- This unit has two scroll modes: Channel Scroll and Category Scroll. See “Using the Category Scrolls”.
- Channel Scroll**: searches for a channel by scrolling every single channel among authorized channels.
- Category Scroll**: searches for a channel using the Channel Category you selected in the menu display.

To turn off the receiver Press **POWER**.

Direct Tuning

You can tune in to the desired channel by directly pressing the numeric buttons (1-0) on the remote commander.

- Press the desired channel number with the numeric buttons on the remote. The display shows the specified channel number.

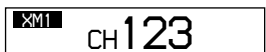

- Press **SELECT** on the remote. Even if you do not press **SELECT**, the channel is tuned in after a few seconds.

Using the Category Scrolls

In Category Scroll mode, you can search for a channel among authorized channels that have the corresponding Channel Category you selected in the menu display.

- Press **JOG roller** (or **MENU** on the remote) to show the menu display. “SCROLL MODE” appears in the display.
- Press **JOG roller** (or **ENTER** on the remote). The current scroll mode appears in the display.



- Turn **JOG roller** (or press **↑/↓** on the remote) to select “CATEGORY SCROLL” and press **JOG roller** (or **ENTER** on the remote). The selected Channel Category appears in the display.



- Turn **JOG roller** (or press **↑/↓** on the remote) to select the desired Channel Category and press **JOG roller** (or **ENTER** on the remote). The unit searches for a channel that has the selected Channel Category from the Channel Number next to the current channel. The CATEGORY indicator appears in the upper left corner of the display.

To cancel a selection

Press **DSPL/BACK/BAND** (or **BACK** on the remote) to return to the previous display during menu operation. Press **MENU** on the remote commander to exit the menu display. The display returns to the tuned channel display.

Tips

- When you tune in to a channel in Category Scroll mode, the Channel Category appears for about 2 seconds in the display.

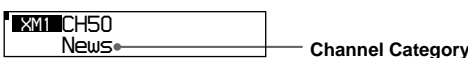

- When there is no channel that has the specified Channel Category, “CH---” is displayed.

Note

When the Category list cannot be received depending on the receiving condition, “-----” is displayed in step 3 above, and you cannot select the Channel Category.

Presetting your Favorite Channels

Preset Tuning

You can preset up to 20 channels onto the preset buttons (1-5) in each band (XM1-XM4). To access the preset channels, simply press the corresponding preset buttons (1-5).

All the preset buttons are preset to Channel Number 1 at the factory.

Presetting a channel

- Follow steps 1 to 2 in “Manual Tuning”.
- Hold down **DSPL/BACK/BAND** for more than 2 seconds, or press **BAND** on the remote to show the display for selecting a band.

- Press **DSPL/BACK/BAND** (or **BAND** on the remote) to select the desired band.

The band changes in the following order:

→ XM1 → XM2 → XM3 → XM4 →

- Turn **JOG roller** (or press **↑/↓** on the remote) to select desired channel you wish to preset.

- Hold down the desired preset button for more than 2 seconds. The preset number appears.



The previous preset channel is deleted and the unit presets the channel being received.

Note

You cannot preset channels using the remote.

Tuning in to a preset channel

- Press **POWER** to turn on the main unit.
- Hold down **DSPL/BACK/BAND** for more than 2 seconds, or press **BAND** on the remote to show the display for selecting a band.
- Press **DSPL/BACK/BAND** (or **BAND** on the remote) to select the desired band. The band changes in the following order:
→ XM1 → XM2 → XM3 → XM4 →
- Press the desired preset button (1-5).

Checking the Tuned Channel Information

This unit has three display modes in the tuned channel display.

- Press **DSPL/BACK/BAND** (or **DSPL** on the remote). The display mode changes as follows:

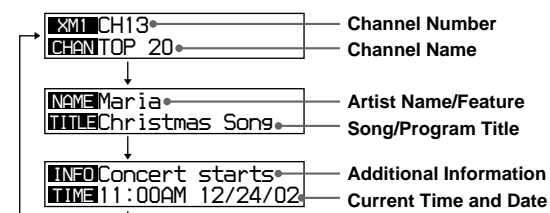

Tips

- When the Additional Information text has more than 16 characters, text will be scrolled every 2 seconds. After all Additional Information is displayed, “--- + --- + --- + --- +” appears for about 2 seconds and then repeats displaying from the beginning.
- As the unit memorizes the display mode when the power is turned off, the display appears in the last display mode when you turn on the unit.

Note

If the channel has no text information, “-----” will appear in the display.

Storing the Information

You can store the text information contained in the tuned-in channel. This unit can store ten sets of the following information:

- Channel Number
- Channel Name
- Artist Name or Feature
- Song or Program Title
- Additional Information and Time/Date

Note

When you store the eleventh set of information, the oldest one will be deleted.

- Press **MENU** when the channel you wish to store the information is received. “MEMORIZED” appears for about 2 seconds and the information is stored in “MEMO 1”. The memory numbers of already stored information increases by one.



Viewing the stored information

- Press **JOG roller** (or **MENU** on the remote) to show the menu display.
- Turn **JOG roller** (or press **↑/↓** on the remote) to select “MEMO” and press **JOG roller** (or **ENTER** on the remote).

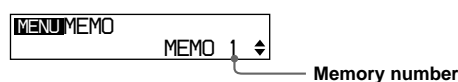

If no information is stored, “NO MEMO” will appear.

- Turn **JOG roller** (or press **↑/↓** on the remote) to select the desired memory number and press **JOG roller** (or **ENTER** on the remote).
- Turn **JOG roller** (or press **↑/↓** on the remote) to scroll the stored text information. The information appears in the following order: Artist Name/Feature → Song/Program Title → Additional Information → Channel Number → Channel Name → Time and date.

To return to the display for selecting the memory number Press **DSPL/BACK/BAND** (or **BACK** on the remote).

To exit the menu display

Press **MENU** on the remote commander. The display returns to the tuned channel display.

Using other Functions

You can also use the following functions in the menu display.

Menu	See
Scroll mode	“Using the Category Scroll”
Memo	“Storing the Information”
Back Light	below
Beep	below
Time Adjust	“Adjusting the Time Difference”
Contrast	below
Auto Power Down	below
Line Out Level	below
Reception Status	below

To cancel a selection

Press **DSPL/BACK/BAND** (or **BACK** on the remote) to return to the previous display. Press **MENU** on the remote commander to exit the menu display.

Note

When no operation is performed for about 1 minute in the menu display except for the Reception Status, the unit cancels a selection and the display returns to the tuned channel display.

Back Light

You can select the lighting level of the display window. The factory-set is “BRIGHT”.

- Press **JOG roller** (or **MENU** on the remote) to show the menu display.
- Turn **JOG roller** (or press **↑/↓** on the remote) to select “BACK LIGHT” and press **JOG roller** (or **ENTER** on the remote). The current setting appears in the display.

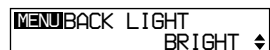

- Turn **JOG roller** (or press **↑/↓** on the remote) to select the desired setting and press **JOG roller** (or **ENTER** on the remote). BRIGHT: makes the display window bright. DIM: makes the display window dim. OFF: turns off the lighting of the display window.

Beep

You can turn the beep on or off. The factory-set is “ON”.

- Press **JOG roller** (or **MENU** on the remote) to show the menu display.
- Turn **JOG roller** (or press **↑/↓** on the remote) to select “BEEP” and press **JOG roller** (or **ENTER** on the remote). The current setting appears in the display.

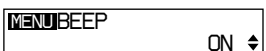

- Turn **JOG roller** (or press **↑/↓** on the remote) to select “ON” or “OFF” and press **JOG roller** (or **ENTER** on the remote).

Contrast

You can adjust the contrast of the display window in 8 levels. The factory-set is level 4.

- Press **JOG roller** (or **MENU** on the remote) to show the menu display.
- Turn **JOG roller** (or press **↑/↓** on the remote) to select “CONTRAST” and press **JOG roller** (or **ENTER** on the remote). The current setting appears in the display.



- Turn **JOG roller** (or press **↑/↓** on the remote) to adjust contrast while checking the display and press **JOG roller** (or **ENTER** on the remote).

Auto Power Down

Auto Power Down function automatically turns off the unit when the specified time passes from the last button operation. The factory-set is “60 min”.

- Press **JOG roller** (or **MENU** on the remote) to show the menu display.
- Turn **JOG roller** (or press **↑/↓** on the remote) to select “AUTO POWER DOWN” and press **JOG roller** (or **ENTER** on the remote). The current setting appears in the display.



- Turn **JOG roller** (or press **↑/↓** on the remote) to select setting and press **JOG roller** (or **ENTER** on the remote). The setting changes as follows:

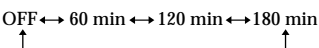

When you select a setting other than “OFF”, the Auto Power Down indicator appears in the lower left corner of the display. To disable the Auto Power Down function, select “OFF.” When the specified time passes, the following messages appear in the display.



2 seconds



When no button is pressed, the unit turns off the power. If you press any button, the timer duration will begin from the start.

Line Out Level

You can adjust the output level of the signal from the LINE OUT jack in 8 levels. The factory-set is level 8 (Maximum).

Standard level adjustment

- When the car connecting pack or RF modulator is connected to the LINE OUT jack of the unit and using it in a car, turn down the Line Out Level to avoid sound distortion.
- When the car connecting pack or RF modulator is not connected to the LINE OUT jack, set the Line Out Level to the maximum level.

- Press **JOG roller** (or **MENU** on the remote) to show the menu display.
- Turn **JOG roller** (or press **↑/↓** on the remote) to select “LINE OUT LEVEL” and press **JOG roller** (or **ENTER** on the remote). The current setting appears in the display.



- Turn **JOG roller** (or press **↑/↓** on the remote) to adjust the Line Out Level while listening to the radio and press **JOG roller** (or **ENTER** on the remote).

Reception Status

When you install the XM antenna for home use, you can check the reception status in 4 levels.

- Press **JOG roller** (or **MENU** on the remote) to show the menu display.
- Turn **JOG roller** (or press **↑/↓** on the remote) to select “RECEPTION STATUS” and press **JOG roller** (or **ENTER** on the remote). The current reception status appears in the display.

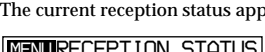

When a reception is poor and you receive interrupted sound, etc. The following indicators appear. In this case, adjust the XM antenna so that two or more indicators light up. See “Placement of the Home Antenna” in the “Digital Audio Receiver Accessory Kit” Installation Guide.

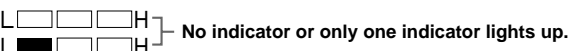

When you obtain a good reception The following indicators appear.

