

Digital Still Camera

Read This First

Operating Instructions

Before operating the unit, please read this manual and "User's Guide/Troubleshooting" (separate volume) thoroughly, and retain it for future reference.

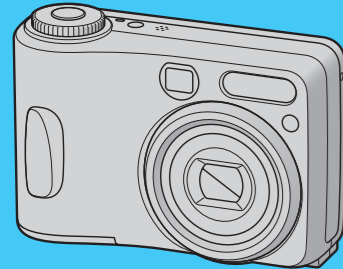

DSC-S60/S80/ST80/S90

Cyber-shot

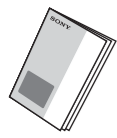

Refer to "User's Guide/Troubleshooting" (separate volume)

Explains advanced techniques and what to do if you experience trouble with your camera.

Printed on 100% recycled paper using VOC (Volatile Organic Compound)-free vegetable oil based ink.



© 2005 Sony Corporation Printed in Japan



2590636110

Checking the accessories supplied

- Ni-MH battery charger BC-CS2A/CS2B (1)
- Power cord (mains lead) (1) (DSC-S90/S80)

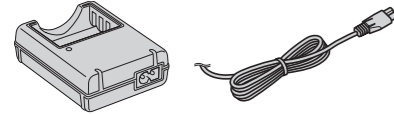

- USB, A/V cable for multi-use terminal (1) (DSC-S90/S80/S60)

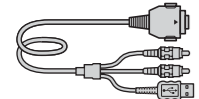

- HR6 (size AA) Nickel-Metal Hydride batteries (2) (DSC-S90/S80)
- R6 (size AA) alkaline batteries (2) (DSC-S60)



- Battery case (1) (DSC-S90/S80)

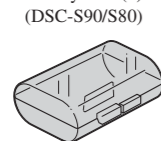

A "Memory Stick" is not supplied. The camera has its own internal memory (32 MB), however, purchase of a "Memory Stick" is recommended.

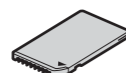

- Wrist strap (1)
- CD-ROM (Cyber-shot application software) (1)
- Operating instructions for digital still camera "Read This First" (this manual) (1)
- Operating instructions "User's Guide/Troubleshooting" (1)

Notes before use

- Charge the supplied batteries before using the camera for the first time. (DSC-S90/S80/ST80 only)
- The camera is a precision instrument. Be careful not to bump the lens or the LCD screen, and not to apply force to it. Attach the strap to prevent the camera from damage by being dropped, etc.

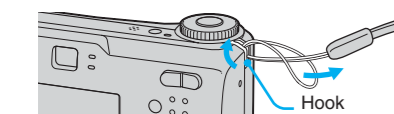

Additional information on this product and answers to frequently asked questions can be found at our Customer Support Website.

http://www.sony.net/

1 Prepare the battery

For DSC-ST80, refer to the operating instructions "Cyber-shot Station".

DSC-S90/S80 only

1 Insert the batteries.

Match ⊕/⊖ and insert.

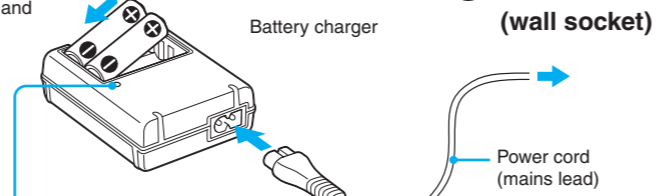

CHARGE lamp

Light on: Charging

Light off: Completed (Remove the batteries.)

3 To wall outlet (wall socket)

2 Connect the power cord (mains lead).

- Connect the battery charger to an easily accessible wall outlet (wall socket) close by.
- Even if the CHARGE lamp is not lit, the battery charger is not disconnected from the AC power source (mains) as long as it is connected to the wall outlet (wall socket). If some trouble occurs while using the battery charger, immediately shut off the power by disconnecting the plug from the wall outlet (wall socket).
- When charging is finished, disconnect the power cord (mains lead) from the wall outlet (wall socket), and remove the Nickel-Metal Hydride batteries from the battery charger.

Nickel-Metal Hydride battery	Charging time
NH-AA-DAx2 (supplied with DSC-S90/S80)	Approx. 6 hours

- Time required to charge fully depleted Nickel-Metal Hydride batteries at a temperature of 25°C (77°F). Charging may take longer under certain circumstances or conditions.
- The CHARGE lamp may remain lit longer than six hours, but this is not a malfunction.

4 Insert the batteries.

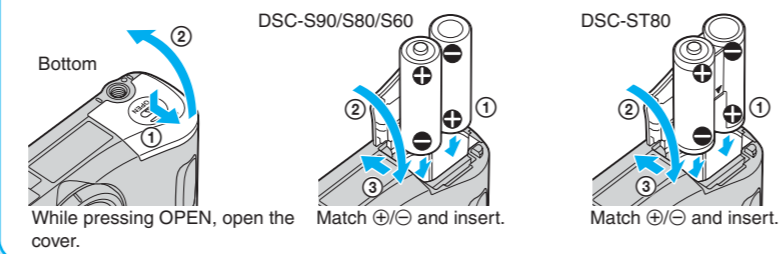

2 Turn the camera on/set the clock

1 Select



2 Press POWER.

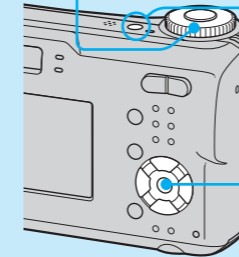
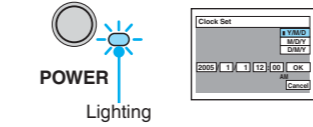

3 Set the clock with the control button.

- 1 Select the date display format with ▲/▼, then press ●.

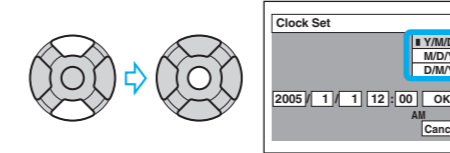

- 2 Select each item with ◀/▶ and set the numeric value with ▲/▼, then press ●.

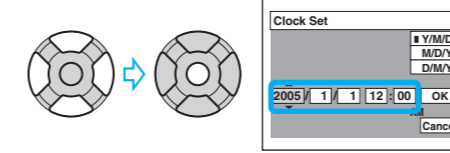

- 3 Select [OK] with ▶, then press ●.

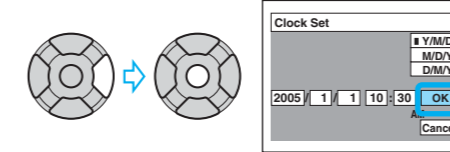

- To cancel, select [Cancel] and press ●.

3 Insert a "Memory Stick" (not supplied)

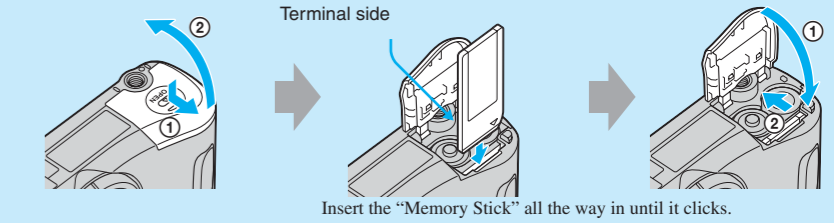

When there is no "Memory Stick" inserted

The camera records/plays back images using the internal memory (32 MB). → "User's Guide/Troubleshooting" (page 23)

4 Select the image size for use

1 Select a mode.

Still image:



Movie:



2 Press

3 Select the size with ▲/▼.

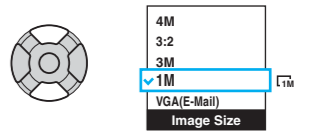

- The screen above is for still images. For movies, select [640(Fine)] ("Memory Stick PRO" only), [640(Standard)] or [160].

4 Press to complete the setting.

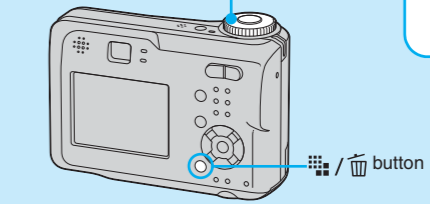

Available batteries

You can use HR 15/51:HR6 (size AA) Nickel-Metal Hydride batteries/R6 (size AA) alkaline batteries/battery pack NP-NH25/ZR6 (size AA) Oxy Nickel Primary Battery. → "User's Guide/Troubleshooting" (page 93)

Using the AC Adaptor

You can connect the camera using the AC-LS5K AC Adaptor (not supplied). → "User's Guide/Troubleshooting" (page 15). Refer to the operating instructions supplied with the AC Adaptor.

To check the remaining battery time

Press POWER to turn on and check the time on the LCD screen.

Battery remaining indicator				
Battery remaining guidelines	Sufficient power remaining	Battery half full	Battery low, recording/playback will stop soon.	Change the batteries with fully charged ones, or charge the batteries. (The warning indicator flashes.)

- The displayed time remaining may not be correct under certain circumstances.
- When using alkaline batteries/Oxy Nickel Primary Battery, the battery remaining indicator may not display the correct information.
- When the AC Adaptor (not supplied) is used, the battery remaining indicator is not displayed.

To remove the batteries

Hold the camera with the battery cover facing upward, then open the battery cover and remove the batteries. Be careful not to drop the batteries.

To use your camera abroad — Power sources

You can use your camera, the battery charger (supplied with DSC-S90/S80), and the AC Adaptor (not supplied) in any country or region where the power supply is within 100 V to 240 V AC, 50/60 Hz. Use a commercially available AC plug adaptor [a], if necessary, depending on the design of the wall outlet (wall socket) [b].

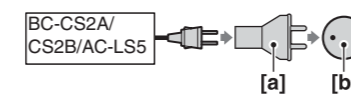

- Do not use an electronic transformer (travel converter), as this may cause a malfunction.

To change the date and time

Select [Clock Set] in the (Setup) screen and perform the procedure in step 3 above. → "User's Guide/Troubleshooting" (page 55)

On the clock display

- If you selected [D/M/Y] in step 1, set the time on a 24-hour cycle.
- Midnight is indicated as 12:00 AM, and noon as 12:00 PM.

When turning on the power

- Unless you set the clock, the Clock Set screen appears each time the camera is turned on.
- Do not touch the lens portion as the cover opens and the lens portion extends. Also, do not leave the camera with the lens portion extended for a long period of time with the power off as this may cause a malfunction.
- The following screen appears when the camera is turned on for the second time or afterwards.

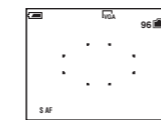

To turn off the power

Press POWER again.

- If the camera is running on battery power and you do not operate the camera for a period of time, the camera turns off automatically to prevent wearing down the battery (Auto power-off function).

Changing the language setting

You can change the screen display to show messages in a specified language. To change the language setting, press MENU to display the menu screen. Select (Setup) with the control button, then, select [Language] in (Setup1), and select the desired language. → "User's Guide/Troubleshooting" (page 53)

On still image sizes

For details on the image size → "User's Guide/Troubleshooting" (page 13)

Image size	Guidelines	No. of images	Printing
4M (2304x1728) (the default setting)	For printing high density images in A4 or A5 size	Less	Fine
3:2 (2304x1536)*		More	Rough
3M (2048x1536)			
1M (1280x960)	For printing in postcard size		
VGA(E-Mail) (640x480)	For recording a larger number of images For attaching images to e-mail or creating web pages		

\*Images are recorded in the same 3:2 aspect ratio as photograph printer paper or postcards, etc.

On recordable number of still images and recordable time of movies

Recordable number of still images and recordable time of movies vary depending on the image size selected.

For details on recordable number or time → "User's Guide/Troubleshooting" (page 22)

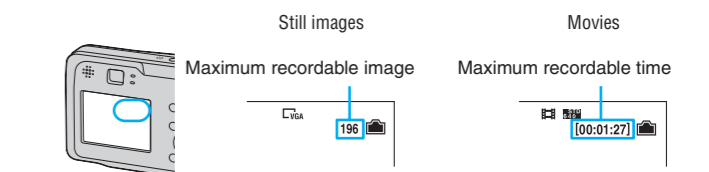

- Number of recordable images and time can differ according to shooting conditions.

To remove a "Memory Stick"

Open the cover, then push the "Memory Stick" in once.

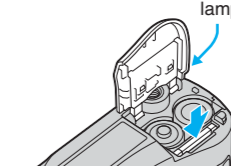

When the access lamp is lit

Never open the cover or turn off the power. The data may be corrupted.

# 5 Shoot images easily (Auto adjustment mode)

## Holding the camera

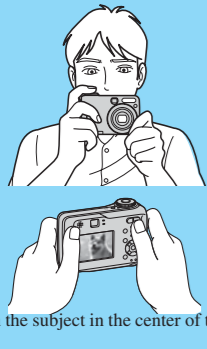

Position the subject in the center of the focus frame.

### 1 Select a mode.

Still image (auto adjustment mode):



Select

Movie:



Select

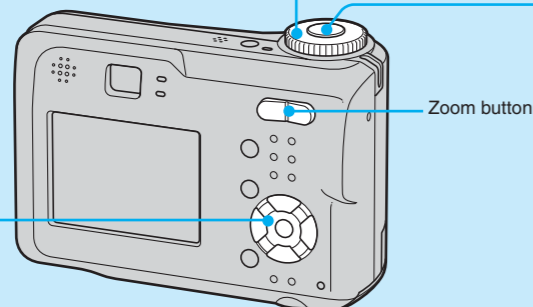

### 2 Shoot with the shutter button.

Still image:

Press and hold halfway down to focus

AE/AF lock indicator  
Flashing → lit/beeps

Press fully down  
The shutter sounds.

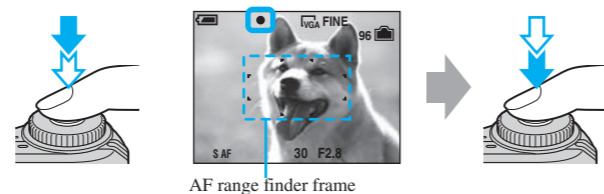

Movie:

Press fully down



To stop recording, press the shutter button fully down again.

# 6 Shoot still images (Scene Selection)

### 1 Select the desired mode of Scene Selection ( , , , , , , ).



• For details on modes, see below.

### 2 Shoot with the shutter button.

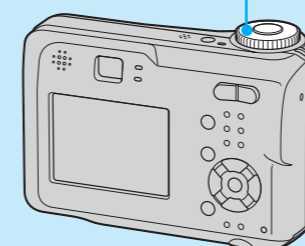

### To cancel the Scene Selection

Set the mode dial to other than the mode of Scene Selection.

# 6 View/delete images

### 1 Select .

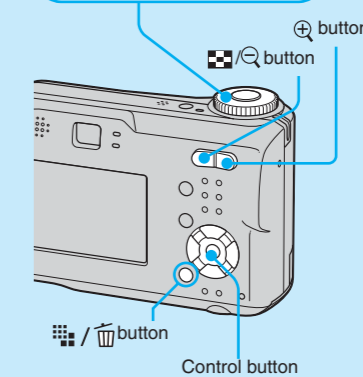
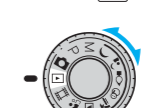

### 2 Select an image with .

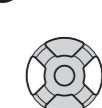

Still image: the image size is displayed  
Movie: is displayed

Movie:

To playback a movie, press .

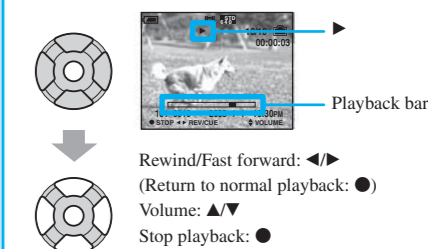

• Movies with the image size [160] are displayed a size smaller.

### Using the control button

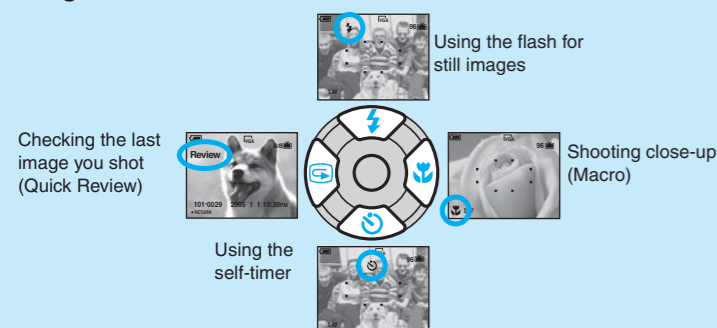

### Using the zoom



- You cannot change the zoom scale while shooting a movie.
- When the zoom scale exceeds 3x, the camera uses [Digital Zoom].

For details on the [Digital Zoom] settings and the image quality → "User's Guide/Troubleshooting" (page 46)

### Checking the last still image you shot (Quick Review)

Press on the control button.  
To cancel, press again.  
• The image may appear rough right after playback starts.  
• To delete the image, press (Delete) and select [Delete] with on the control button, then press .

### Selecting a flash mode for still images

Before step 2, press on the control button repeatedly until the desired mode is selected.

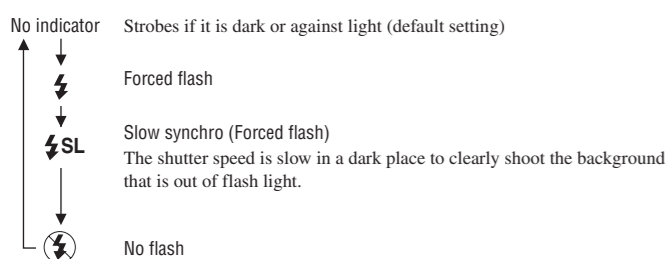

- Shooting distance (when [ISO] is set to [Auto])  
W side: Approx. 0.2 to 4.5 m (7 7/8 to 178 1/2 inches)  
T side: Approx. 0.5 to 2.5 m (19 3/4 to 98 1/2 inches)
- The flash strobos twice. The first time is to adjust the light quantity.

### Shooting close-up (Macro)

Before step 2, press on the control button.  
To cancel, press again.  
• Setting the zoom all the way to the W side is recommended.  
• The in-focus range becomes narrow, and the complete subject may not entirely be in focus.  
• The AF speed drops.

Shortest shooting distance from the lens surface  
Setting all the way to the W side: Approx. 10 cm (4 inches)  
Setting all the way to the T side: Approx. 50 cm (19 3/4 inches)

### Using the self-timer

Before step 2, press on the control button.  
Press the shutter button, the self-timer lamp flashes, and a beep sounds until the shutter operates (approximately 10 seconds later).



### If you shoot a still image of a subject that is difficult to focus on

- If the subject is closer than approx. 50 cm (19 3/4 inches), use the Macro mode (left column).
- When the camera cannot focus on the subject automatically, the AE/AF lock indicator changes to flashing slowly and the beep does not sound. Reposition the shot and focus again.

#### Subjects difficult to focus on are:

- Distant from the camera and dark
- The contrast between the subject and its background is poor.
- Seen through glass
- Moving fast
- Reflect light or have a lustrous finish
- Flashing
- Against light

#### To identify items on the screen

→ "User's Guide/Troubleshooting" (page 17)

#### To turn off the LCD screen

Press (Display/LCD on/off) repeatedly. Use the finder for saving battery power, or shooting images when it is difficult to confirm images using the LCD screen.

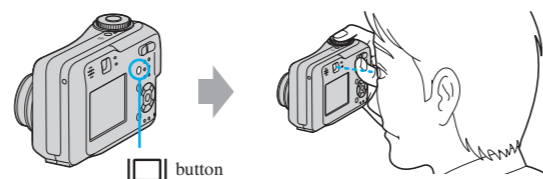

### Scene Selection modes

The following modes are predetermined to match the scene conditions.

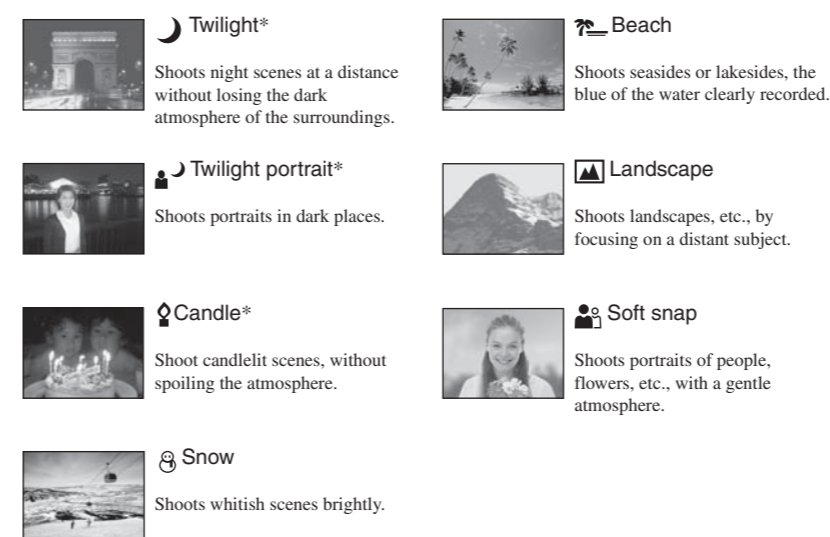

\*The shutter speed becomes slower, so using a tripod is recommended.

### To use the functions set by the control button with Scene Selection

Before shooting in step 2, select the settings with the control button. Some functions are not available, depending on the Scene Selection mode. When you press the button to select functions that cannot be combined with Scene Selection, a beep sounds. → "User's Guide/Troubleshooting" (page 27)

### To view an enlarged image (playback zoom)

While displaying a still image, press to zoom in on the image.  
To undo the zoom, press .  
Adjust the portion:   
Cancel playback zoom:   
To store enlarged images: [Trimming] → "User's Guide/Troubleshooting" (page 44)

### Viewing an index screen

Press (index), then select an image with .

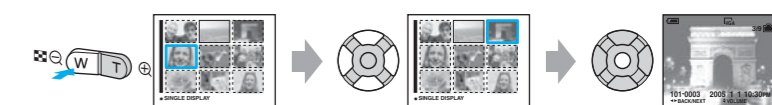

If you press again, the sixteen-image index screen appears.

### To delete images in index mode

1 While an index screen is displayed, press (Delete) and select [Select] with on the control button, then press .

2 Select the image you want to delete with , then press to display the (Delete) indicator on the selected image.

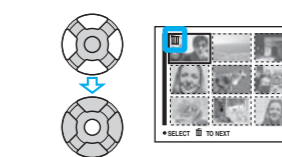

#### To cancel a selection

Select an image you have previously selected for deletion, then press to delete the indicator from the image.

3 Press (Delete).

4 Select [OK] with , then press .

• To delete all the images in the folder, select [All In This Folder] with in step 1 instead of [Select], then press .