

# ***Portable CD Player***

---

## Operating Instructions

### **About the area code**

The area code of the location in which you purchased the CD player is shown on upper left of the bar code label on the package. For accessories supplied with your CD player, check the area code of your model and see “Accessories (supplied/optional).”



## ***D-SJ17CK***

## **CAUTION**

The use of optical instruments with this product will increase eye hazard.

Certain countries may regulate disposal of the battery used to power this product. Please consult with your local authority.

**For the customers in the USA and Canada**

### **DISPOSAL OF NICKEL METAL HYDRIDE BATTERY.**

#### **NICKEL METAL HYDRIDE BATTERY. DISPOSE OF PROPERLY.**

You can return your unwanted nickel metal hydride batteries to your nearest Sony Service Center or Factory Service Center.

**Note:** In some areas the disposal of nickel metal hydride batteries in household or business trash may be prohibited.

For the Sony Service Center nearest you call 1-800-222-SONY (United States only)

For the Sony Factory Service Center nearest you call 416-499-SONY (Canada only)

**Caution:** Do not handle damaged or leaking nickel metal hydride battery.



The CE mark on the CD player is valid only for products marketed in the European Union.

# Table of Contents

## Getting started

Locating the Controls ..... 4

## Playing a CD

1. Connect your CD player. .... 6

2. Insert a CD. .... 6

3. Play a CD. .... 7

## Playback options

Playing tracks repeatedly (Repeat play) .... 10

Playing a single track (Single play) ..... 10

Playing tracks in random order  
(Shuffle play) ..... 10

Playing tracks in your favorite order  
(PGM play) ..... 11

## Available features

G-PROTECTION function ..... 12

Emphasizing the bass sound (SOUND) .... 12

Protecting your hearing (AVLS) ..... 13

Locking the controls (HOLD) ..... 13

Turning off the operation beep sound ..... 14

## Connecting your CD player

Connecting a stereo system ..... 15

## Installing in a car

Where to place your CD player ..... 16

Mounting your CD player ..... 16

Replacing the fuse of the car battery cord . 17

## Connecting a power source

Using the AC power adaptor ..... 18

Using the rechargeable batteries ..... 18

Using dry batteries ..... 20

Notes on the power source ..... 21

## Additional information

Precautions ..... 22

Maintenance ..... 23

Troubleshooting ..... 24

Specifications ..... 25

Accessories (supplied/optional) ..... 26

# Getting started

## Locating the Controls

For details, see pages in parentheses.

### CD player (front)

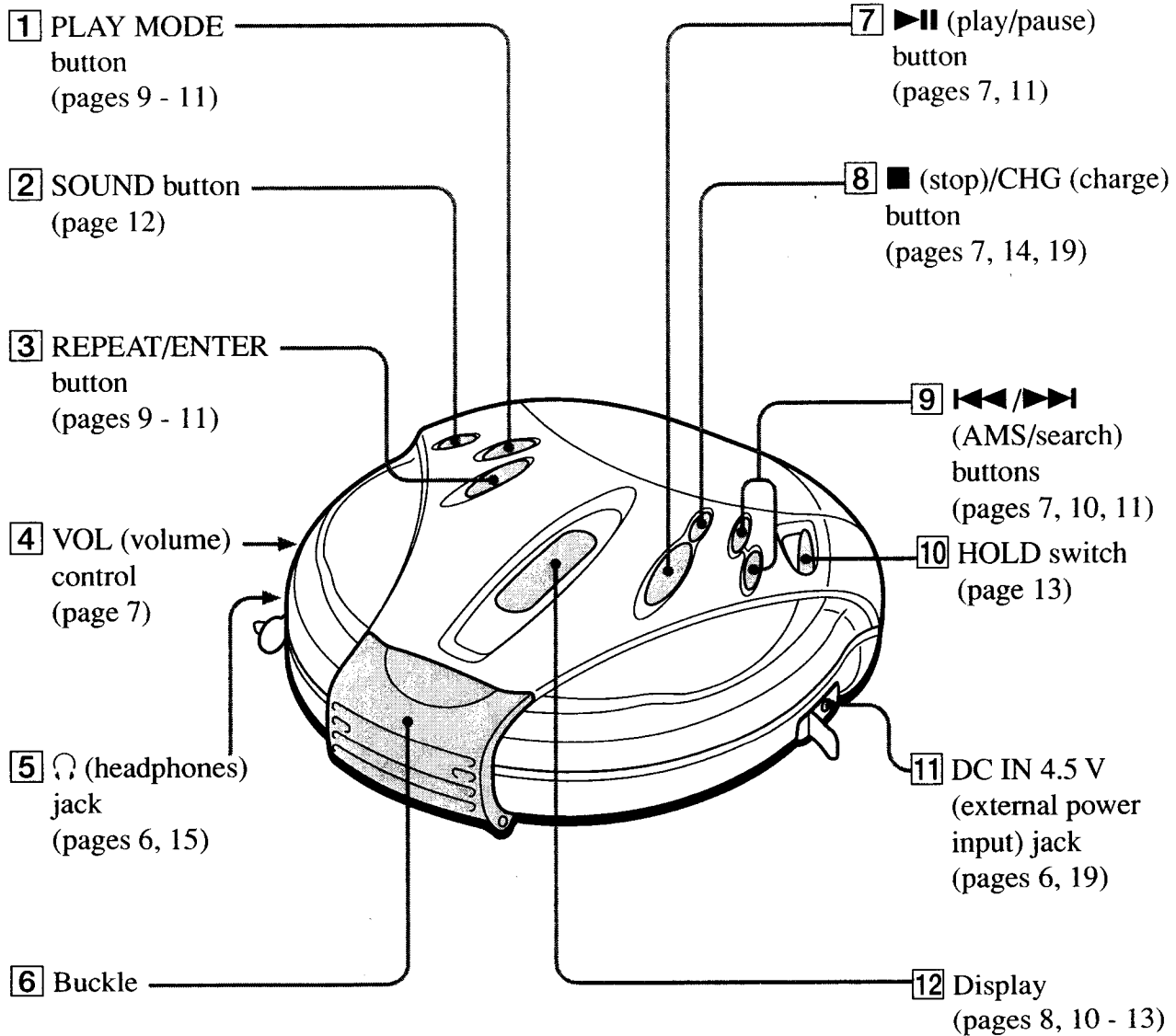

### CD player (inside)

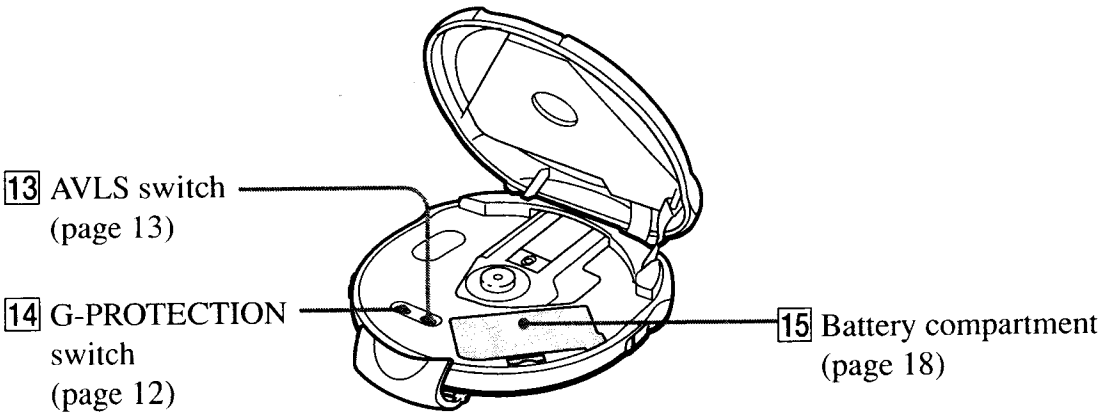

### Using the hand strap

While jogging, use the supplied hand strap.

1 Pass the strap through the hooks.

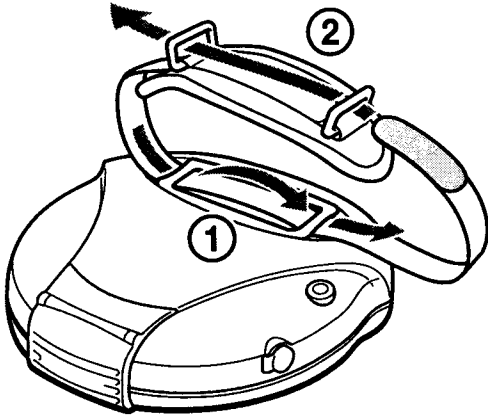

2 Put your hand between the player and the strap, then adjust the length of the strap and fix it using the Velcro tapes.

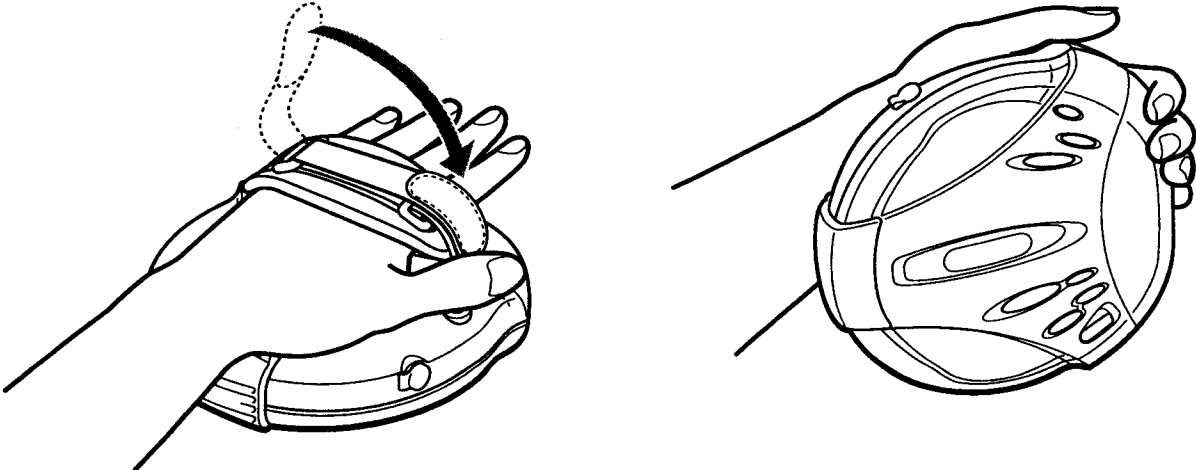

# Playing a CD

You can also use rechargeable batteries, dry batteries and house current (AC power adaptor) as a power source.

## 1. Connect your CD player.

- 1 Connect the car connecting pack.
- 2 Connect the car battery cord.

### Note

Turn down the volume of the car cassette deck before inserting the car connecting pack.

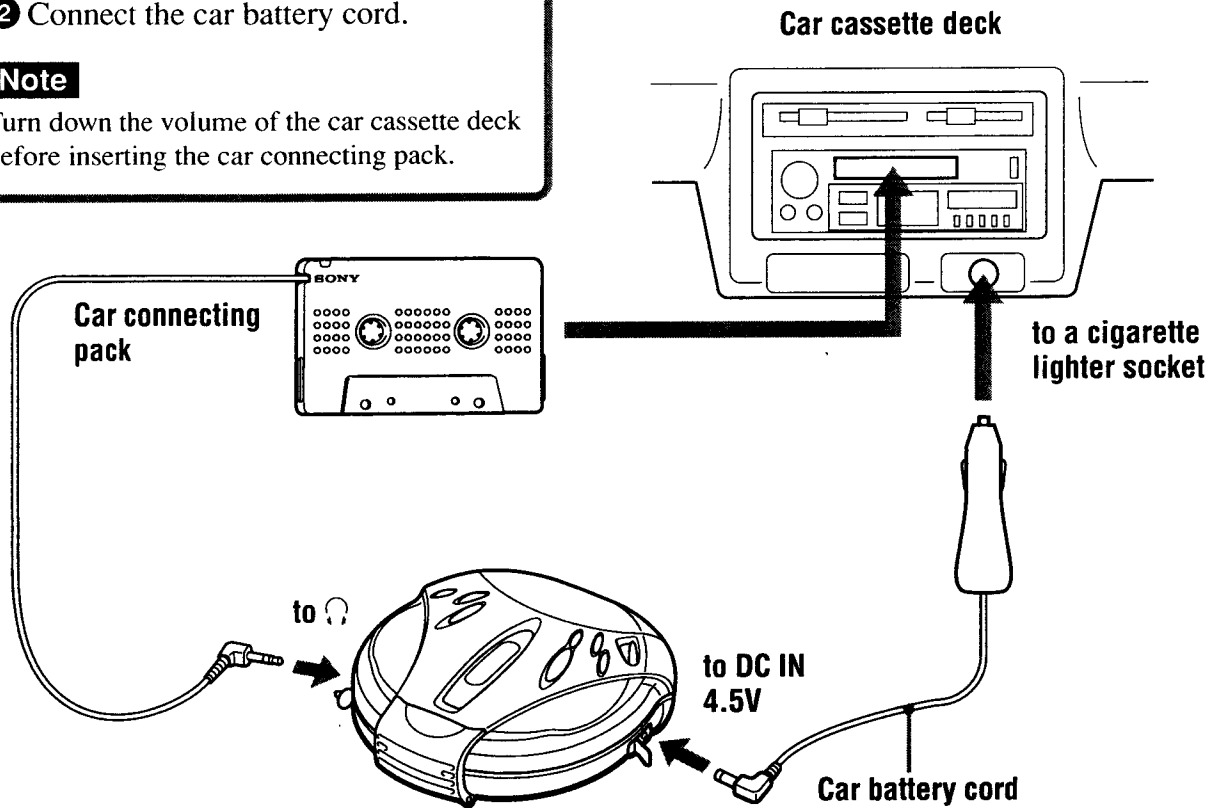

## 2. Insert a CD.

- 1 Unfasten the buckle.
- 2 Open the lid.
- 3 Fit the CD on the pivot and close the lid.
- 4 While holding the lid closed, fasten the buckle securely.

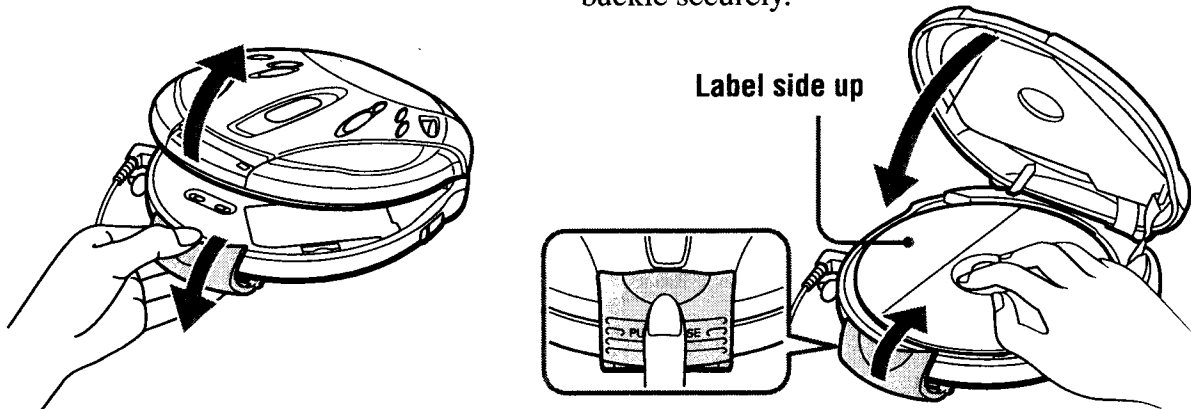

### 3. Play a CD.

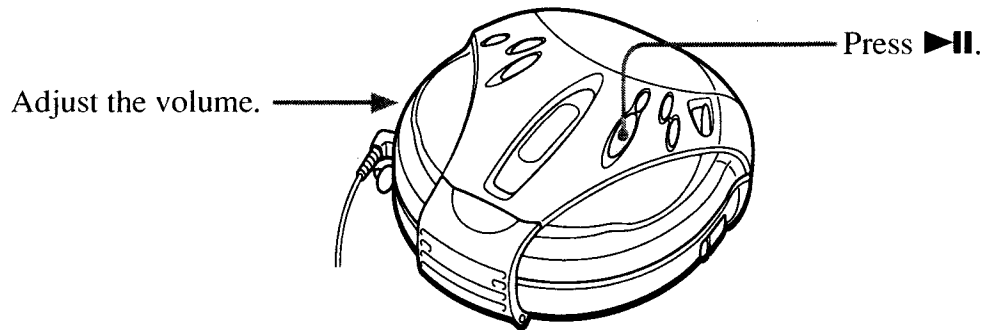

You can also adjust the volume on the car cassette deck.

To	Press
Play/Pause	►
Stop	■/CHG* <sup>2</sup>
Find the beginning of the current track (AMS* <sup>1</sup> )	◀◀ once quickly* <sup>2</sup>
Find the beginning of the previous tracks (AMS)	◀◀ repeatedly* <sup>2</sup>
Find the beginning of the next track (AMS)	▶▶ once quickly* <sup>2</sup>
Find the beginning of the succeeding tracks (AMS)	▶▶ repeatedly* <sup>2</sup>
Go backwards quickly	Hold down ◀◀* <sup>2</sup>
Go forward quickly	Hold down ▶▶* <sup>2</sup>

\*<sup>1</sup> Automatic Music Sensor

\*<sup>2</sup> These operations can be done during both play and pause.

(Continued)

## About the display

- When you press ►|| after changing the CD or turning off and on the player, the total number of tracks in the CD and total playing time appear for about two seconds.
- During play, the track number and the elapsed playing time of the current track appear.
- Between tracks, the time to the beginning of the next track appears with the “-” indication.
- During pause, the elapsed playing time flashes.

## If the volume level does not increase

Is AVLS set to “LIMIT”? Set AVLS to “NORM.” For details, see “Protecting your hearing (AVLS).”

## Playback starts from the point you stopped

Your CD player can recall the playback point where you stopped and then resume playing from the same place (resume function). There is no ON/OFF switch of the resume function on this CD player.

## Removing the CD

Remove the CD while pressing the pivot in the center of the tray.

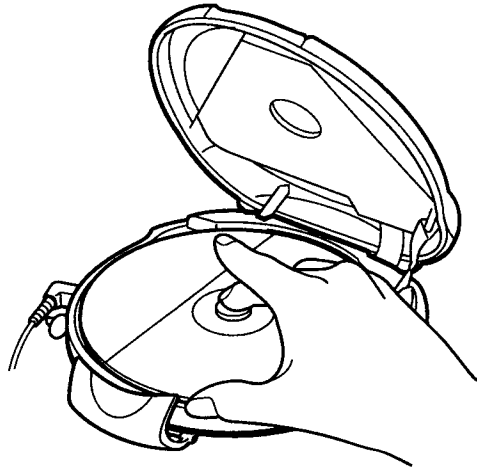



# Playback options

You can enjoy various ways of playback using PLAY MODE and REPEAT/ENTER.

## PLAY MODE button

Each time you press the button, you can change the playback mode.

No indication  
(Normal play)

↓  
"1"

(Play a single track)

↓  
"SHUF"

(Play tracks in random order)

↓  
"PGM"

(Play tracks in your favorite order)

## REPEAT/ENTER button

### REPEAT

You can repeat play that is selected using PLAY MODE.

### ENTER

You can select tracks for PGM play mode.

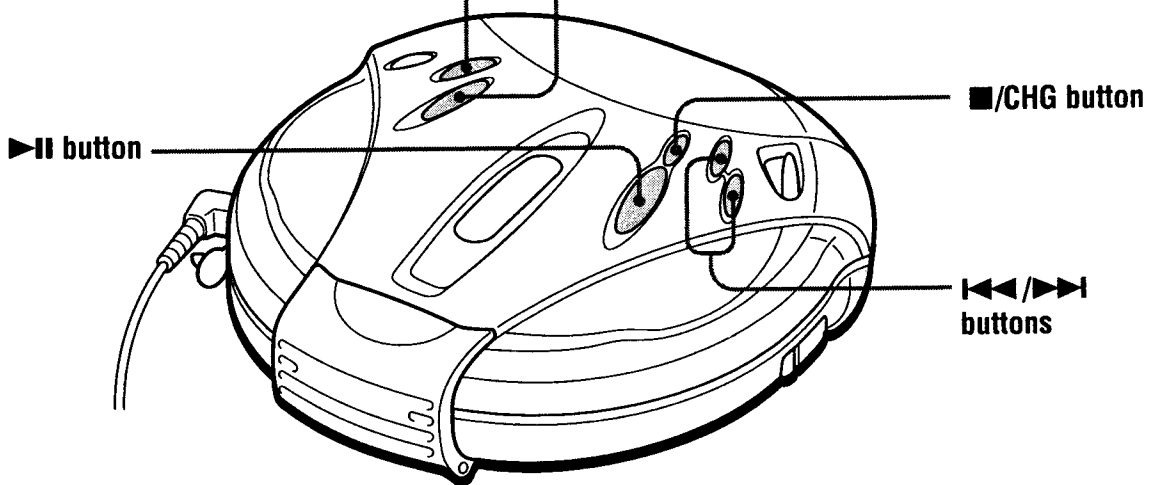

---

## Playing tracks repeatedly (Repeat play)

You can play tracks repeatedly in normal, single, shuffle and PGM play modes.

---

During playback, press REPEAT/ENTER.



---

### Note on ⏮/⏭

During Repeat play, you can locate the first track after the last track by pressing ⏭ repeatedly. You can also locate the last track after first track by pressing ⏮ repeatedly.

---

## Playing a single track (Single play)

During playback, press PLAY MODE repeatedly until "1" appears.

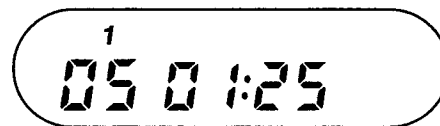

---

## Playing tracks in random order (Shuffle play)

During playback, press PLAY MODE repeatedly until "SHUF" appears.

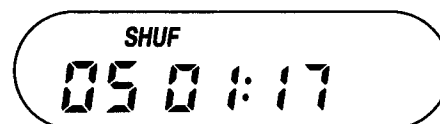

## Playing tracks in your favorite order (PGM play)

You can program the CD player to play up to 64 tracks in your favorite order.

- 1 During playback, press PLAY MODE repeatedly until "PGM" appears.



- 2 Press ◀◀ or ▶▶ to select a track.

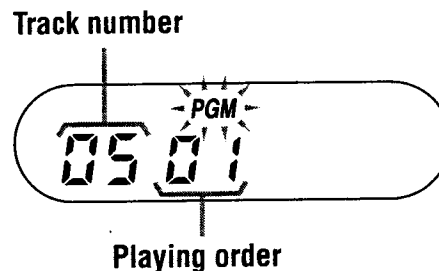

- 3 Press REPEAT/ENTER to enter the selected track.  
"00" appears and the playing order increases by one.

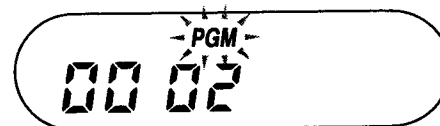

- 4 Repeat steps 2 and 3 to select the tracks in your favorite order.
- 5 Press ▶|| to start the PGM play.

### To check the program

#### During programming:

Press REPEAT/ENTER repeatedly before step 5.

#### During the PGM play:

Press PLAY MODE repeatedly until "PGM" flashes, then press REPEAT/ENTER. Each time you press REPEAT/ENTER, the track number appears.

#### Notes

- When you finish entering the 64th track in step 3, the first selected track appears in the display.
- If you select more than 64 tracks, the first selected tracks are erased.

## ► Available features

### G-PROTECTION function

The G-PROTECTION function has been developed to provide excellent protection against sound skipping while jogging. This function provides a higher level of shock protection than the traditional one.

While jogging, use the supplied hand strap (see “Using the hand strap” in Locating the controls).

Set G-PROTECTION (under the lid) to “ON.”

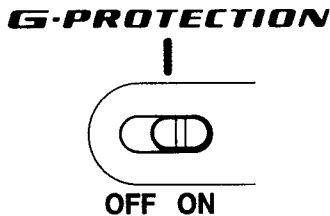

### To turn off the G-PROTECTION function

Set G-PROTECTION to “OFF.”

#### Note

Sound may skip if:

- the CD player receives stronger continuous shock than expected or
- a dirty or scratched CD is played.

### Emphasizing the bass sound (SOUND)

You can emphasize the bass-boosted sound.

Press SOUND to select “BASS ■” or “BASS ■■.”

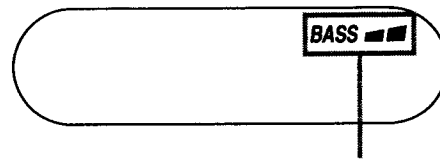
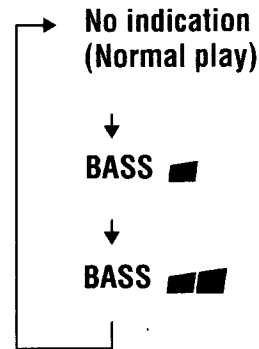

The selected sound mode is displayed.

“BASS ■■” enhances the bass sound more than “BASS ■.”

#### Note

If the sound is distorted when using the SOUND function, turn down the volume.

---

## Protecting your hearing

### (AVLS)

The AVLS (Automatic Volume Limiter System) function keeps down the maximum volume to protect your hearing.

---

Set AVLS (under the lid) to "LIMIT."

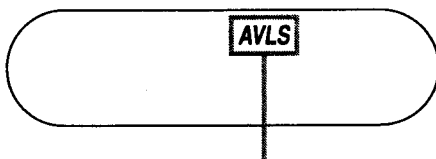
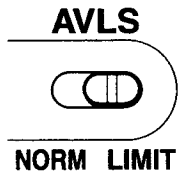

Displayed when "LIMIT" is selected and AVLS function is working.

---

**To turn off the AVLS function**

Set AVLS to "NORM."

---

## Locking the controls

### (HOLD)

You can lock the controls on your CD player to prevent accidental button presses.

---

Slide HOLD in the direction of the arrow.



Displayed when the HOLD function is working.

---

**To unlock the controls**

Slide HOLD in the opposite direction of the arrow.

---

## **Turning off the operation beep sound**

You can turn off the beep sound that is heard from your headphones/earphones when you operate your CD player.

---

**1** Remove the power source (AC power adaptor, rechargeable batteries or dry batteries) from the CD player.

---

**2** Connect the power source while pressing ■/CHG.

---

### **To turn on the beep sound**

Remove the power source and then connect the power source without pressing ■/CHG.

## ► Connecting your CD player

### Connecting a stereo system

You can listen to CDs through a stereo system and record CDs on a cassette tape. For details, see the instruction manual that comes with the connected device.

Be sure to turn off all connected devices before making connections.

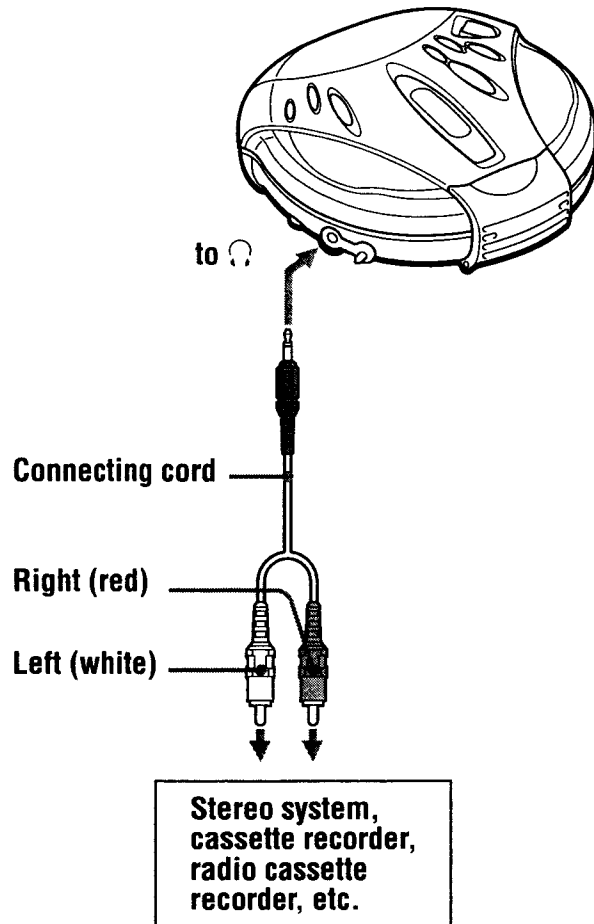

### Notes

- Before you play a CD, turn down the volume of the connected device to avoid damaging the connected speakers.
- Use the AC power adaptor for recording. If you use the rechargeable batteries or dry batteries as a power source, batteries may become completely depleted during recording.
- Adjust the volume properly on the connected device so that the sound will not be distorted.

## ► Installing in a car

### Where to place your CD player

- Install the CD player in a location which:
  - does not interfere with your driving.
  - is not dangerous for passengers.
  - does not interfere with the glove box lid or ashtray.
  - is stable, and where nothing around it may interfere with installation.
- Do not install the CD player near heat sources or where subject to direct sunlight, excessive dust, or moisture (especially on a dashboard.)

Please understand that we will not incur any obligations for troubles caused by incorrect installation.

If you have any questions or problems concerning your CD player, please contact your nearest Sony dealer.

### Mounting your CD player

Attach the CD player to the console box with the supplied Velcro tapes.

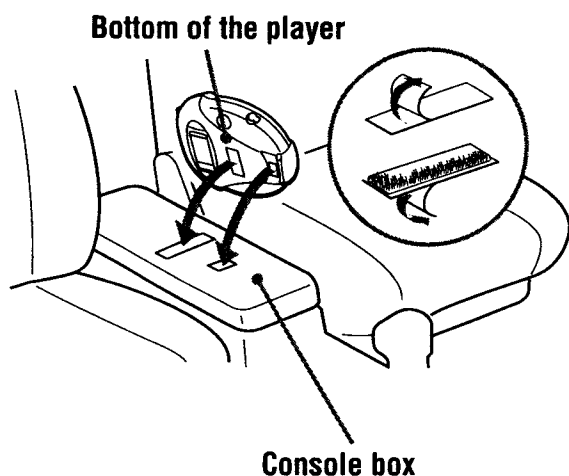

### Notes

- Do not affix Velcro tapes to the name plate or the lid of the battery compartment.
- When you are going to park your car for a long period of time, remove the player from the Velcro tapes so that it will not be exposed to direct sunlight.

### To route the cord

Use the supplied spiral tube to route the cords so that they do not interfere with your driving.

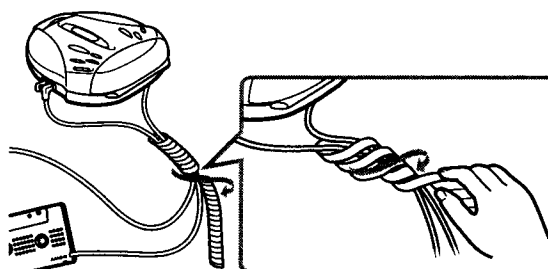

### Note on the car battery cord

The 4.5V DC plug supplied with car battery cord conforms to the proposed standards of the Electronic Industries Association of Japan (EIAJ). Do not connect it to other players.

### Polarity of the plug (EIAJ standards)





## Replacing the fuse of the car battery cord

If the CD player does not operate, check the fuse. If it is blown, replace it as follows:

- 1 Turn off the CD player and remove the cigarette lighter plug from the cigarette lighter socket.**
- 2 Remove the plug end by turning it counterclockwise.**
- 3 Remove the defective fuse from the plug.**
- 4 Insert a new fuse into the plug.**
- 5 Replace the plug end by turning it clockwise.**

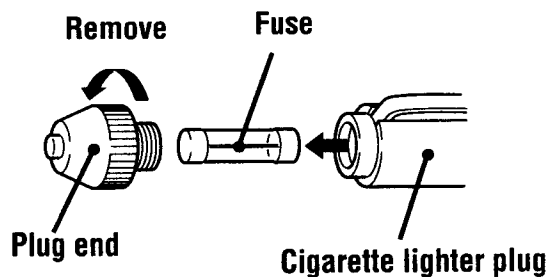

### Notes

- Be sure to use a fuse of the same amperage and length as the one to be replaced. Never use a piece of wire as a substitute for the fuse.
- If the fuse is blown again after replacing it, contact your nearest Sony dealer. In such a case, bring the defective fuse to the dealer with you.

### Notes on the car connecting pack

- If no sound is heard or the car connecting pack is ejected, change the direction of playback on the car cassette deck.
- Never insert the cord end of the car connecting pack into the cassette insertion door. Otherwise, the cord may break or the car cassette deck may be damaged.
- You cannot use the car connecting pack with some car cassette deck.
- The cord should be placed so that it does not hinder driving.
- To disconnect the cord from the CD player, pull it out by grasping the plug. Never pull the plug out by the cord.
- With some car cassette decks, you may hear some rattling noise from the car connecting pack. However, this is not a sign of malfunction.

## ► **Connecting a power source**

You can use the following power sources:

- AC power adaptor
- Rechargeable batteries
- LR6 (size AA) alkaline batteries

For the battery life and charging time of the rechargeable batteries, see “Specifications.”

---

## **Using the AC power adaptor**

Connect the supplied AC power adaptor to the DC IN 4.5 V jack and an AC outlet.

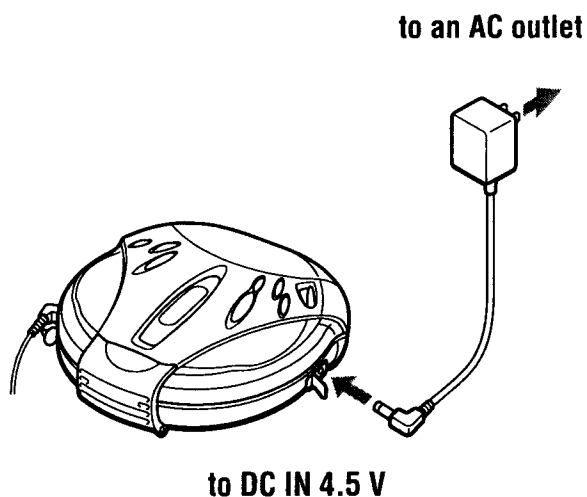

---

## **Using the rechargeable batteries**

Charge the rechargeable batteries before using them for the first time. You can use only the following rechargeable batteries for your CD player.

- NH-WM2AA

- 
- 1** Open the battery compartment lid inside your CD player.

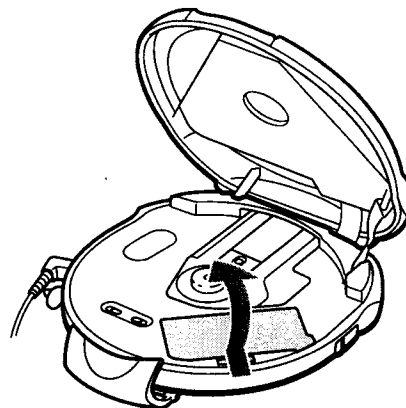

- 
- 2** Insert two rechargeable batteries by matching the  $\oplus$  to the diagram in the battery compartment and close the lid until it clicks into place.

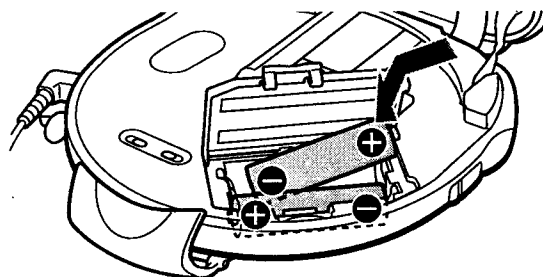

**3** Connect the AC power adaptor to the DC IN 4.5 V jack of your CD player and an AC outlet, then press ■/CHG to start charging.

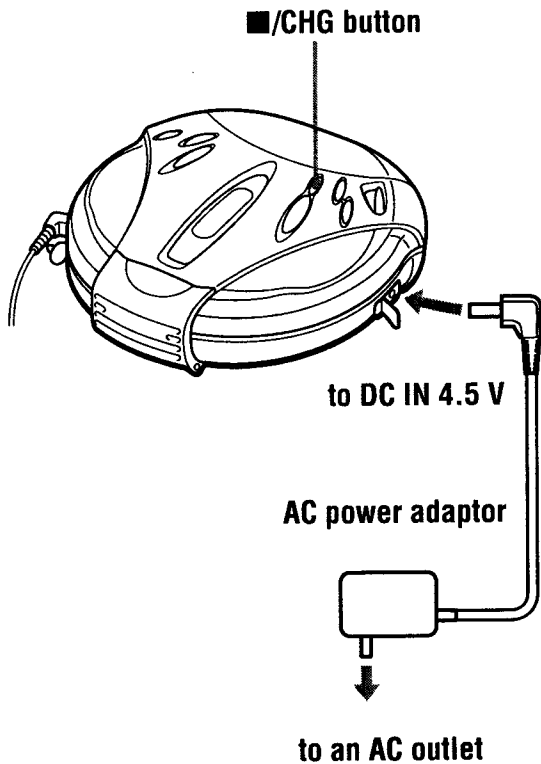

The CD player charges the batteries. The “CHG” indicator turns on in the display, and the indicator sections of light up in succession. When the batteries are completely charged, the “CHG” and indicators turn off. If you press ■/CHG after the charge has already been completed, the indicator flashes and “Full” appears in the display.

**4** Disconnect the AC power adaptor.

**To remove the rechargeable batteries**

Remove the batteries as illustrated below.

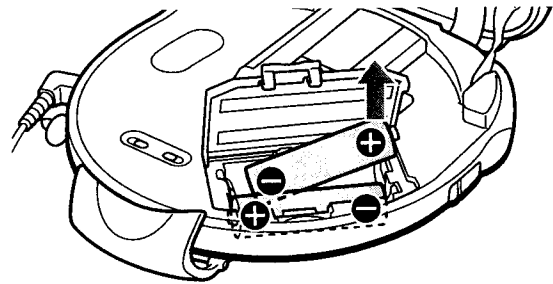

**When to charge the rechargeable batteries**

You can check the remaining power of the batteries in the display.

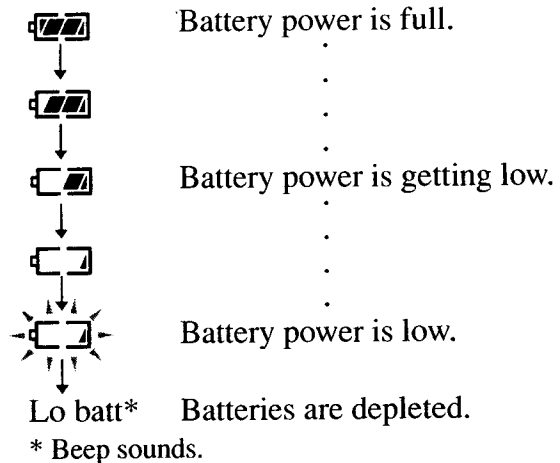

To keep the original battery capacity for a long time, charge the batteries only when they are completely depleted.

**Notes**

- The indicator sections of roughly show the remaining battery power. One section does not always indicate one-fourth of the battery power.
- Depending on operating conditions, the indicator sections of may increase or decrease.

(Continued)

## Using the rechargeable batteries

### When to replace the rechargeable batteries

If the battery life becomes shorter by about half, replace the batteries with new rechargeable batteries.

### Note on the rechargeable batteries

If the battery is new or has not been used for a long time, it may not be charged completely until you charge and discharge it several times.

### Note on carrying the rechargeable batteries

Use the supplied battery carrying case to prevent unexpected heat. If the rechargeable batteries and the metallic objects are contacted, heat or fire may occur due to a short circuit.

### To attach the battery compartment lid

If the battery compartment lid is detached by an accidental drop, excessive force, etc., attach it as illustrated below.

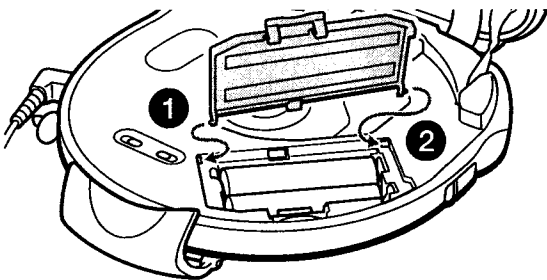

## Using dry batteries

Use only the following dry battery type for your CD player:

- LR6 (size AA) alkaline batteries

### Note

Be sure to remove the AC power adaptor when using the dry batteries.

### 1 Open the battery compartment lid.

### 2 Insert two LR6 (size AA) batteries by matching the ⊕ to the diagram in the battery compartment.

### To remove the batteries

Remove the batteries in the same way as rechargeable batteries.

### When to replace the batteries

You can check the remaining power of the batteries in the display.

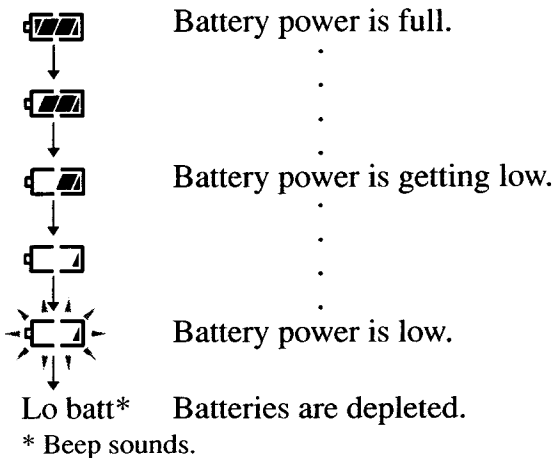

When the batteries are depleted, replace both batteries with new ones.

---

## Notes on the power source

Disconnect all power sources when the CD player is not used.

### On AC power adaptor

- Use only the AC power adaptor supplied or recommended in “Accessories (supplied/ optional).” Do not use any other AC power adaptor. It may cause a malfunction.

#### Polarity of the plug



- When disconnecting the AC power adaptor from the AC outlet, grasp the adaptor itself. Do not pull it by the cord.
- Do not touch the AC power adaptor with wet hands.

### On rechargeable batteries and dry batteries

- Do not charge the dry batteries.
- Do not throw the batteries into fire.
- Do not carry the batteries with coins or other metallic objects. It can generate heat if the positive and negative terminals of the battery are accidentally contacted by a metallic object.
- Do not mix rechargeable batteries with dry batteries.
- Do not mix new batteries with old ones.
- Do not use different types of batteries together.
- When the batteries are not to be used for a long time, remove them.
- If battery leakage occurs, wipe off any deposit in the battery compartment, and install new batteries. In case the deposit adheres to you, wash it off thoroughly.

## ► **Additional information**

### **Precautions**

#### **On safety**

- Should any solid objects or liquid fall into the CD player, unplug it and have it checked by qualified personnel before operating it any further.
- Do not put any foreign objects in the DC IN 4.5 V (external power input) jack.

#### **On the CD player**

- Keep the lens on the CD player clean and do not touch it. If you do so, the lens may be damaged and the CD player will not operate properly.
- Do not put any heavy object on top of the CD player. The CD player and the CD may be damaged.
- Do not leave the CD player in a location near heat sources, or in a place subject to direct sunlight, excessive dust or sand, moisture, rain, mechanical shock, unlevelled surface, or in a car with its windows closed.
- If the CD player causes interference to the radio or television reception, turn off the CD player or move it away from the radio or television.

#### **On handling CDs**

- To keep the CD clean, handle it by its edge. Do not touch the surface.
- Do not stick paper or tape onto the CD.

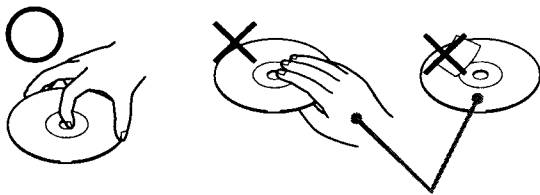

**Not these ways**

- Do not expose the CD to direct sunlight or heat sources such as hot air ducts. Do not leave the CD in a car parked under direct sunlight.

### **On headphones/earphones**

#### **Road safety**

Do not use headphones/earphones while driving, cycling, or operating any motorized vehicle. It may create a traffic hazard and is illegal in some areas. It can also be potentially dangerous to play your headsets at high volume while walking, especially at pedestrian crossings. You should exercise extreme caution or discontinue use in potentially hazardous situations.

#### **Preventing hearing damage**

Avoid using headphones/earphones at high volume. Hearing experts advise against continuous, loud and extended play. If you experience a ringing in your ears, reduce volume or discontinue use.

#### **Consideration for others**

Keep the volume at a moderate level. This will allow you to hear outside sounds and to be considerate to the people around you.

#### **On the water resistance**

- Before unfastening the buckle to open the lid, be sure to wipe off water, dust or sand on the exterior of the unit. Open and close the lid where water or sand cannot fall in the unit, and make sure that your hands are dry. If water or sand falls in the unit, trouble may occur.
- When closing the lid, check that there is no dust or sand on the rubber packing around the lid. Then close the lid firmly with the buckle.
- The supplied headphones are not meant to be immersed in water or come in continuous contact with water. If they are accidentally dropped into water or get wet, dry them with a soft cloth. Never use an electric hair dryer.

- The supplied AC power adaptor is not water resistant. To prevent shock hazard, avoid using the player near water during AC operation.
- Cover the DC IN 4.5 V jack and  $\Omega$  jack with the attached rubber caps when nothing is connected to these jacks. If the inside of the jacks are contaminated with water or sand, rust may develop and cause trouble.

### Notes

- Since the unit is airtight, you may not be able to open the lid when there is a sudden change in air pressure inside the unit. This happens when the unit is transported on a plane or moved from a warm place to a cold place. In this case, open the rubber cap on the DC IN 4.5 V jack.
- To prevent water from leaking in, the buckle is designed to be slightly stiff. Be careful not to catch a fingernail on the buckle when unfastening the lid.

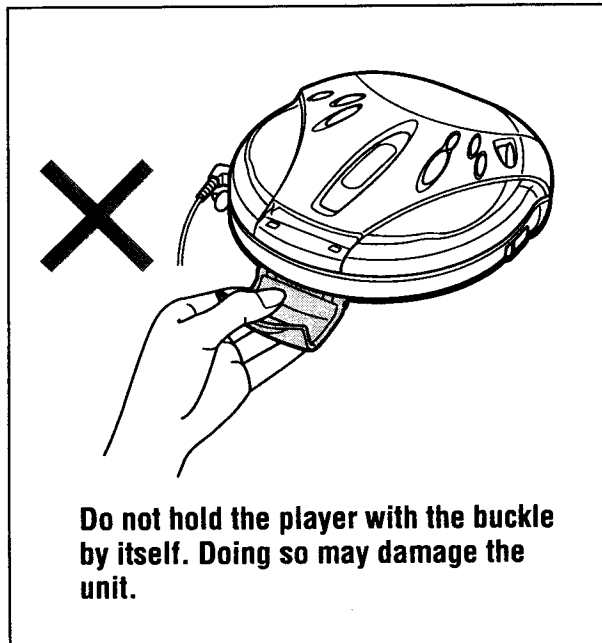

## Maintenance

### To clean the casing

Use a soft cloth slightly moistened in water or a mild detergent solution. Do not use alcohol, benzine or thinner.

### To clean the headphones plug

Keep the plug of your headphones clean to obtain optimum sound. Wipe it with a dry, soft cloth.

### To remove any dust or sand from the rubber packing

Any sand or dust on the rubber packing will prevent the lid from shutting tightly, and water may leak in. Brush off the dust once in a while.

We recommend the replacement of the rubber packing every year which is available optionally at an authorized Sony service facility.

# Troubleshooting

Should any problem persist after you have checked these symptoms, consult your nearest Sony dealer.

Symptom	Cause and/or corrective actions
The volume does not increase even if the VOL control is adjusted to the maximum level.	→ Set the AVLS switch to "NORM." (page 13)
No sound, or noise is heard.	→ Connect the plugs firmly. (page 6) → Plugs are dirty. Clean the plugs with a dry soft cloth periodically.
The playing time is too short when powered with the dry batteries.	→ Check that you are using alkaline batteries and not manganese batteries. (page 20) → Replace the batteries with new LR6 (size AA) alkaline batteries. (page 20)
The playing time is too short when powered with the rechargeable batteries.	→ Charge and discharge the rechargeable batteries several times. (pages 18 - 20)
When you press ►II, "Lo batt" or "00" appears in the display. The CD does not play.	→ The rechargeable batteries are used up completely. Charge the batteries. (pages 18, 19) → Replace the batteries with new LR6 (size AA) alkaline batteries. (page 20)
"HI dc In" appears in the display.	→ Use only the AC power adaptor or car battery cord in "Accessories (supplied/optional)." (page 26) → Remove all power sources, then insert the batteries or connect the AC power adaptor again. (pages 6, 18, 19, 20)
The CD does not play or "no DISC" appears in the display when a CD is placed in the CD player.	→ The CD is dirty or defective. (page 22) → Check that the CD is inserted with the label side up. (page 6) → Moisture condensation has occurred. Leave the CD player aside for several hours until the moisture evaporates. → Close the lid of the battery compartment firmly. (page 18) → Make sure the batteries are inserted correctly. (pages 18 - 20) → Connect the AC power adaptor to an AC outlet securely. (page 18)
"Hold" appears in the display when you press a button, and the CD does not play.	→ The buttons are locked. Slide the HOLD switch back. (page 13)
The CD player does not start charging.	→ During stop, press ■/CHG. (page 19)
Rustling noise of the CD is heard.	→ Close the lid of the battery compartment firmly. (page 18)



# Specifications

## System

Compact disc digital audio system

## Laser diode properties

Material: GaAlAs

Wavelength:  $\lambda = 780 \text{ nm}$

Emission duration: Continuous

Laser output: Less than  $44.6 \mu\text{W}$

(This output is the value measured at a distance of 200 mm from the objective lens surface on the optical pick-up block with 7 mm aperture.)

## D-A conversion

1-bit quartz time-axis control

## Frequency response

40 - 20 000 Hz  $\pm 1$  dB (measured by EIAJ CP-307)

## Output (at 4.5 V input level)

Headphones (stereo minijack)

Approx. 5 mW + Approx. 5 mW at 16  $\Omega$

## Power requirements

For the area code of the model you purchased, check the upper left side of the bar code on the package.

- Sony NH-WM2AA rechargeable batteries: 2.4 V DC
- Two LR6 (size AA) batteries: 3 V DC
- AC power adaptor (DC IN 4.5 V jack):  
U2/CA2/E92/MX2 model: 120 V, 60 Hz  
CED/CET/CEW/CEX/CE7/EE/EE1/E13/G5/  
G6/G7/G8 model:  
220 - 230 V, 50/60 Hz  
CEK/3CE7 model: 230 - 240 V, 50 Hz  
EA3 model: 110 - 240 V, 50/60 Hz  
AU2 model: 240 V, 50 Hz  
JE.W/E33 model: 100 - 240 V, 50/60 Hz  
HK2 model: 220 V, 50/60 Hz  
AR1/CN2 model: 220 V, 50 Hz
- Sony DCC-E345 car battery cord for use on car battery: 4.5 V DC

## Battery life\* (approx. hours)

(When you use the CD player on a flat and stable surface.)

Playing time varies depending on how the CD player is used.

When using	G-PROTECTION function	
	on	off
NH-WM2AA (charged for about 5 hours**)	23	25
Two Sony alkaline batteries LR6(SG)	37	40

\* Measured value by the standard of EIAJ (Electronic Industries Association of Japan).

\*\* Charging time varies depending on how the rechargeable battery is used.

## Operating temperature

5°C - 35°C (41°F - 95°F)

## Dimensions (w/h/d) (excluding projecting parts and controls)

Approx. 143 × 37 × 136 mm

(5  $\frac{3}{4}$  × 1  $\frac{1}{2}$  × 5  $\frac{3}{8}$  in.)

## Mass (excluding accessories)

Approx. 343 g (12.1 oz.)

Design and specifications are subject to change without notice.

---

## Accessories (supplied/optional)

### Supplied accessories

For the area code of the location in which you purchased the CD player, check the upper left side of the bar code on the package.

AC power adaptor (1)  
Headphones (1)  
Hand strap (1)  
Car battery cord (1)  
Car connecting pack (1)  
Velcro tape (2)  
Spiral tube (1)

### Optional accessories

AC power adaptor	AC-E45HG
Active speaker system	SRS-Z500 SRS-T1
Car battery cord	DCC-E345
Car battery cord with car connecting pack	DCC-E34CP
Car connecting pack	CPA-9C
Connecting cord	RK-G129 RK-G136
Rechargeable battery	NH-WM2AA
Earphones	MDR-E848LP MDR-EX70LP MDR-A44L MDR-A110LP

Your dealer may not handle some of the above listed accessories. Please ask the dealer for detailed information about the accessories in your country.



---

Sony  line <http://www.world.sony.com/>

---

Sony Corporation Printed in USA