

TFT LCD Color Computer Display

Operating Instructions

GB

***SDM-HS75
SDM-HS95***

Owner's Record

The model and serial numbers are located at the rear of the unit. Record these numbers in the spaces provided below. Refer to them whenever you call upon your dealer regarding this product.
Model No. _____ Serial No. _____

WARNING

To reduce the risk of fire or electric shock, do not expose this apparatus to rain or moisture.

Dangerously high voltages are present inside the unit. Do not open the cabinet. Refer servicing to qualified personnel only.

FCC Notice

This equipment has been tested and found to comply with the limits for a Class B digital device, pursuant to Part 15 of the FCC Rules. These limits are designed to provide reasonable protection against harmful interference in a residential installation. This equipment generates, uses, and can radiate radio frequency energy and, if not installed and used in accordance with the instructions, may cause harmful interference to radio communications. However, there is no guarantee that interference will not occur in a particular installation. If this equipment does cause harmful interference to radio or television reception, which can be determined by turning the equipment off and on, the user is encouraged to try to correct the interference by one or more of the following measures:

- Reorient or relocate the receiving antenna.
- Increase the separation between the equipment and receiver.
- Connect the equipment into an outlet on a circuit different from that to which the receiver is connected.
- Consult the dealer or an experienced radio/TV technician for help.

You are cautioned that any changes or modifications not expressly approved in this manual could void your authority to operate this equipment.

IMPORTANTE
Para prevenir cualquier mal funcionamiento y evitar daños, por favor, lea detalladamente este manual de instrucciones antes de conectar y operar este equipo.

**If you have any questions about this product, you may call;
Sony Customer Information Services Center
1-800-222-7669 or <http://www.sony.com/>**

Declaration of Conformity

Trade Name: SONY
Model: SDM-HS75
SDM-HS95
Responsible Party: Sony Electronics Inc.
Address: 16450 W. Bernardo Dr,
San Diego, CA 92127 U.S.A.
Telephone Number: 858-942-2230

This device complies with part 15 of the FCC rules. Operation is subject to the following two conditions: (1) This device may not cause harmful interference, and (2) this device must accept any interference received, including interference that may cause undesired operation.

NOTICE
This notice is applicable for USA/Canada only. If shipped to USA/Canada, install only a UL LISTED/CSA LABELLED power supply cord meeting the following specifications:



SPECIFICATIONS

Plug Type	Nema-Plug 5-15p
Cord	Type SVT or SJT, minimum 3 x 18 AWG
Length	Maximum 15 feet
Rating	Minimum 7 A, 125 V

NOTICE
Cette notice s'applique aux Etats-Unis et au Canada uniquement. Si cet appareil est exporté aux Etats-Unis ou au Canada, utiliser le cordon d'alimentation portant la mention UL LISTED/CSA LABELLED et remplissant les conditions suivantes:

SPECIFICATIONS

Type de fiche	Fiche Nema 5-15 broches
Cordon	Type SVT ou SJT, minimum 3 x 18 AWG
Longueur	Maximum 15 pieds
Tension	Minimum 7 A, 125 V



As an ENERGY STAR Partner, Sony Corporation has determined that this product meets the ENERGY STAR guidelines for energy efficiency.

Table of Contents

Precautions	4
Identifying parts and controls	5
Setup	7
Step 1: Open the stand	7
Step 2: Connect the display to your computer	7
Step 3: Connect the power cord	8
Step 4: Secure the cords and replace the back cover	8
Step 5: Turn on the monitor and computer	9
Adjusting the tilt	9
Customizing Your Monitor	10
Adjusting to the desired brightness	10
Navigating the menu	10
Adjusting the backlight (BACKLIGHT)	11
Adjusting the contrast (CONTRAST)	12
Adjusting the black level of an image (BRIGHTNESS)	12
Adjusting the picture's sharpness and centering (SCREEN)	12
Adjusting the color temperature (COLOR)	13
Changing the gamma setting (GAMMA)	14
Adjusting the sharpness (SHARPNESS)	14
Changing the menu's position (MENU POSITION)	14
Selecting the on-screen menu language (LANGUAGE)	15
Additional settings	15
Technical Features	16
Power saving function	16
Reducing the power consumption (&O mode)	16
Automatic picture quality adjustment function	16
Troubleshooting	17
On-screen messages	17
Trouble symptoms and remedies	18
Specifications	20

GB

- Macintosh is a trademark licensed to Apple Computer, Inc., registered in the U.S.A. and other countries.
- Windows® and MS-DOS are registered trademarks of Microsoft Corporation in the United States and other countries.
- IBM PC/AT and VGA are registered trademarks of IBM Corporation of the U.S.A.
- VESA and DDC™ are trademarks of the Video Electronics Standards Association.
- ENERGY STAR is a U.S. registered mark.
- Adobe and Acrobat are trademarks of Adobe Systems Incorporated.
- All other product names mentioned herein may be the trademarks or registered trademarks of their respective companies.
- Furthermore, “™” and “®” are not mentioned in each case in this manual.

Precautions

Warning on power connections

- Use the supplied power cord. If you use a different power cord, be sure that it is compatible with your local power supply.

For the customers in the U.S.A.

If you do not use the appropriate cord, this monitor will not conform to mandatory FCC standards.

For the customers in the UK

If you use the monitor in the UK, be sure to use the appropriate UK power cord.

Example of plug types

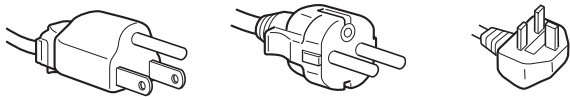

for 100 to 120 V AC for 200 to 240 V AC for 240 V AC only

The equipment should be installed near an easily accessible outlet.

Installation

Do not install or leave the monitor:

- In places subject to extreme temperatures, for example near a radiator, heating vent, or in direct sunlight. Subjecting the monitor to extreme temperatures, such as in an automobile parked in direct sunlight or near a heating vent, could cause deformations of the casing or malfunctions.
- In places subject to mechanical vibration or shock.
- Near any equipment that generates a strong magnetic field, such as a TV or various other household appliances.
- In places subject to inordinate amounts of dust, dirt, or sand, for example near an open window or an outdoor exit. If setting up temporarily in an outdoor environment, be sure to take adequate precautions against airborne dust and dirt. Otherwise irreparable malfunctions could occur.

Place this unit on a flat surface. Do not place it on an uneven surface like the edge of a desk. If a part of this unit sticks out from such surface, it may fall or cause damaged and injury.

Handling the LCD screen

- Do not leave the LCD screen facing the sun as it can damage the LCD screen. Take care when you place the monitor by a window.
- Do not push on or scratch the LCD screen. Do not place a heavy object on the LCD screen. This may cause the screen to lose uniformity or cause LCD panel malfunctions.
- If the monitor is used in a cold place, a residual image may appear on the screen. This is not a malfunction. The screen returns to normal as the temperature rises to a normal operating level.
- If a still picture is displayed for a long time, a residual image may appear for a while. The residual image will eventually disappear.
- The LCD panel becomes warm during operation. This is not a malfunction.

Note on the LCD (Liquid Crystal Display)

Please note that the LCD screen is made with high-precision technology. However, black points or bright points of light (red, blue, or green) may appear constantly on the LCD screen, and irregular colored stripes or brightness may appear on the LCD screen. This is not malfunction.

(Effective dots: more than 99.99%)

Maintenance

- Be sure to unplug the power cord from the power outlet before cleaning your monitor.
- Clean the LCD screen with a soft cloth. If you use a glass cleaning liquid, do not use any type of cleaner containing an anti-static solution or similar additive as this may scratch the LCD screen's coating.
- Clean the cabinet, panel, and controls with a soft cloth lightly moistened with a mild detergent solution. Do not use any type of abrasive pad, scouring powder, or solvent, such as alcohol or benzene.
- Do not rub, touch, or tap the surface of the screen with sharp or abrasive items such as a ballpoint pen or screwdriver. This type of contact may result in a scratched picture tube.
- Note that material deterioration or LCD screen coating degradation may occur if the monitor is exposed to volatile solvents such as insecticide, or if prolonged contact is maintained with rubber or vinyl materials.

Transportation

- Disconnect all cables from the monitor and grasp the monitor firmly with both hands when transporting. If you drop the monitor, you may be injured or the monitor may be damaged.
- When you transport this monitor for repair or shipment, use the original carton and packing materials.

Installation on a wall or a mounting arm

If you intend to install the display on a wall or a mounting arm, be sure to consult qualified personnel.

Note that the back cover must be removed for this type of installation.

Disposal of the monitor

- Do not dispose of this monitor with general household waste.**
- The fluorescent tube used in this monitor contains mercury. Disposal of this monitor must be carried out in accordance to the regulations of your local sanitation authority.**

Identifying parts and controls

See the pages in parentheses for further details.

The ⏻ (power) switch and the control buttons are on the lower right part of the front of the monitor.

Front of the display

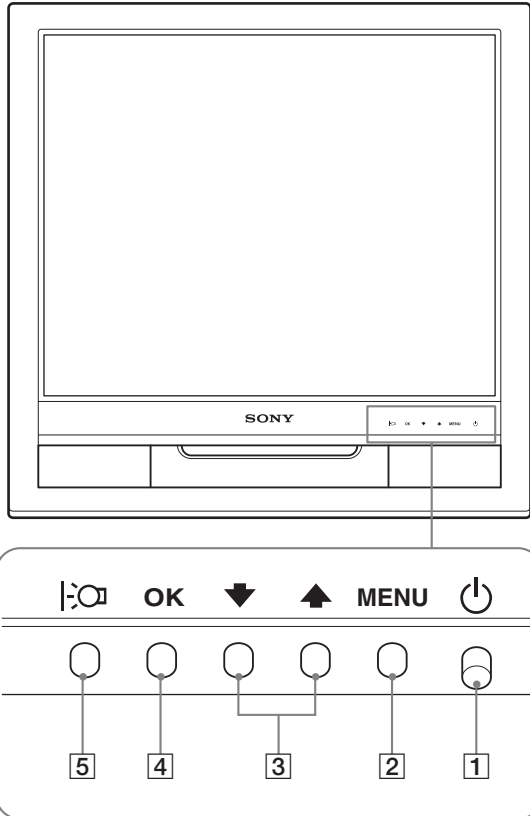

Rear of the display

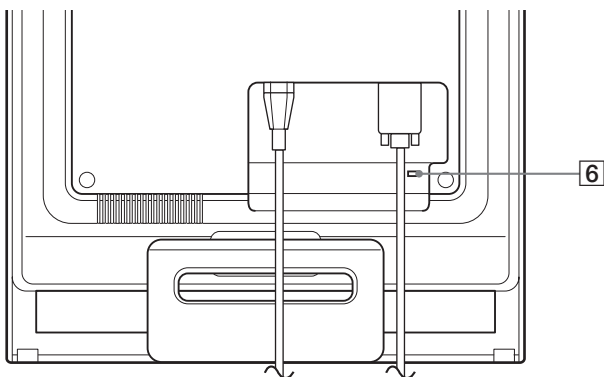

1 ⏻ (Power) switch and indicator (pages 9, 16)

To turn the display on or off, press the ⏻ (power) switch upward.

The power indicator lights up in green when the display is turned on, and lights up in orange when the monitor is in power saving mode.

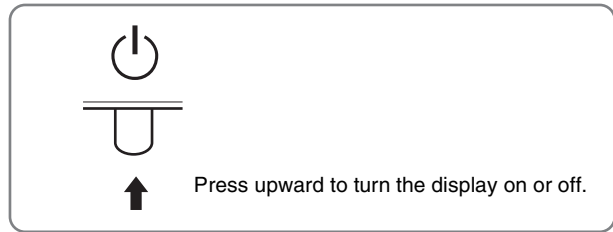

2 MENU button (pages 10, 11)

This button displays or closes the main menu.

3 ↓/↑ buttons (page 11)

These buttons function as the ↓/↑ buttons when selecting the menu items and making adjustments.

4 OK button (page 11)

This button selects the item or executes the settings in the menu.

5 ☀️ button (page 10)

This button is used to change the brightness of the screen.

6 Security Lock Hole

The security lock hole should be applied with the Kensington Micro Saver Security System.

Micro Saver Security System is a trademark of Kensington.

GB

Rear of the display

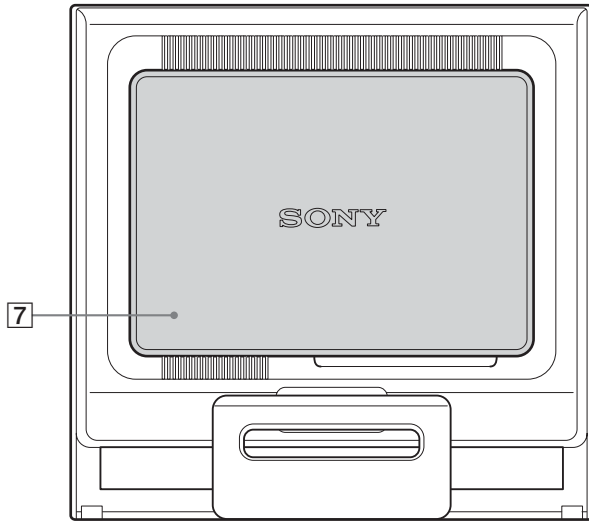

Remove the back cover.

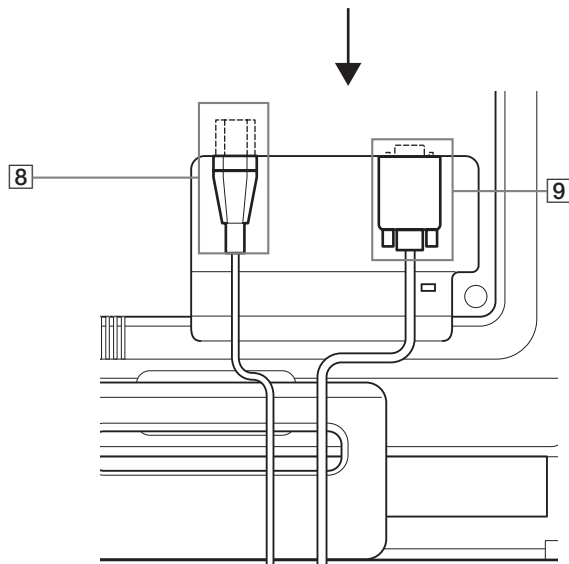

7 Back cover (page 8)

Remove this cover when you connect/disconnect cables or cords.

8 AC IN connector (page 8)

Connect the power cord (supplied).

9 HD15 input connector (analog RGB) (page 7)

This connector inputs analog RGB video signals (0.7 V_{p-p}, positive) and SYNC signals.

Setup

Before using your monitor, check that the following items are included in your carton:

- LCD display
- Power cord
- HD15-HD15 video signal cable (analog RGB)
- Cord strap
- CD-ROM (utility software for Windows/Macintosh, Operating Instructions, etc.)
- Warranty card
- Quick Setup Guide

Step 1: Open the stand

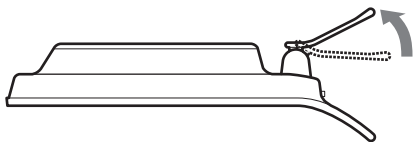

Note

The stand is folded at the factory. Be sure not to place the display vertically with the stand as it is. Otherwise, the display may topple over.

Step 2: Connect the display to your computer

Turn off the monitor and computer before connecting.

Notes

- Do not touch the pins of the video signal cable connector as this might bend the pins.
- Check the alignment of the HD15 connector to prevent bending the pins of the video signal cable connector.

Connect a computer equipped with an HD15 output connector (analog RGB)

Using the supplied HD15-HD15 video signal cable (analog RGB), connect the computer to the monitor's HD15 input connector (analog RGB).

Connect the computer according to the following illustrations.

■ Connecting to an IBM PC/AT or compatible computer

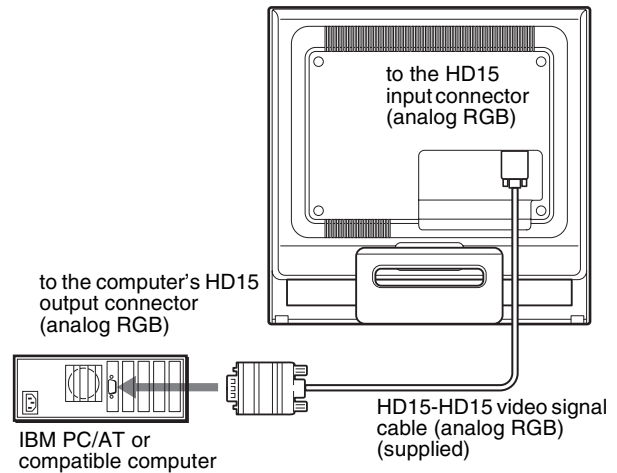

GB

■ Connecting to a Macintosh computer

When connecting this monitor to a Macintosh computer, use the Macintosh adapter (not supplied) if necessary. Connect the Macintosh adapter to the computer before connecting the cable.

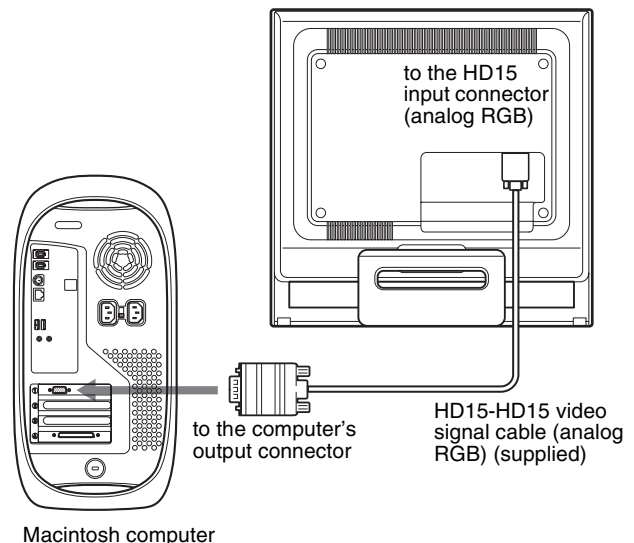

Step 3: Connect the power cord

With the monitor and computer switched off, first connect the power cord to the monitor, then connect it to a power outlet.

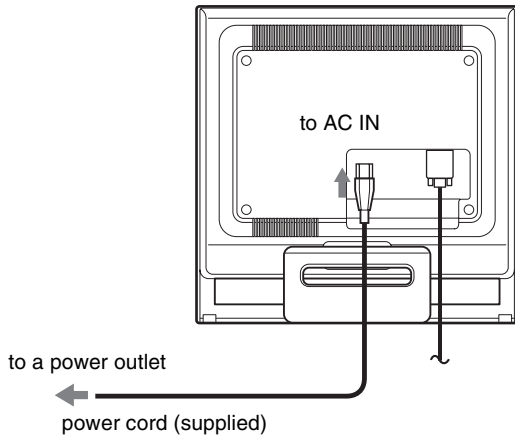

Step 4: Secure the cords and replace the back cover

1 Bundle the cables and cords.

Using the supplied cord strap, bundle the cables and cords.

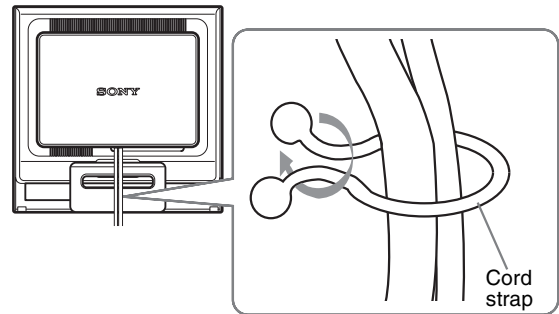

The illustration of the back of the monitor shown here is that of the SDM-HS75. The same applies for the other models.

2 Replace the back cover.

Step 5: Turn on the monitor and computer

1 Press the (power) switch upward.

The  (power) indicator of the monitor lights up in green.

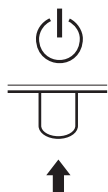

2 Turn on the computer.

The installation of your monitor is complete. If necessary, use the monitor's controls to adjust the picture.

If no picture appears on your screen

- Check that the power cord and the video signal cable are properly connected.
- **If NO INPUT SIGNAL appears on the screen:**
The computer is in the power saving mode. Try pressing any key on the keyboard or moving the mouse.
- **If CABLE DISCONNECTED appears on the screen:**
Check that the video signal cable is properly connected.
- **If OUT OF RANGE appears on the screen:**
Reconnect the old monitor. Then adjust the computer's graphics board within the following ranges.

	SDM-HS75	SDM-HS95
Horizontal frequency	28–80 kHz	28–80 kHz
Vertical frequency	48–75 Hz	48–75 Hz
Resolution	1280 × 1024 or less	1280 × 1024 or less

For more information about the on-screen messages, see “Trouble symptoms and remedies” on page 18.

No need for specific drivers

The monitor complies with the “DDC” Plug & Play standard and automatically detects all the monitor's information. No specific driver needs to be installed to the computer.

The first time you turn on your computer after connecting the monitor, the setup Wizard may appear on the screen. In this case, follow the on-screen instructions. The Plug & Play monitor is automatically selected so that you can use this monitor.

The vertical frequency turns to 60 Hz.

Since flickers are unobtrusive on the monitor, you can use it as it is. You do not need to set the vertical frequency to any particular high value.

Adjusting the tilt

This display can be adjusted within the angles shown below.

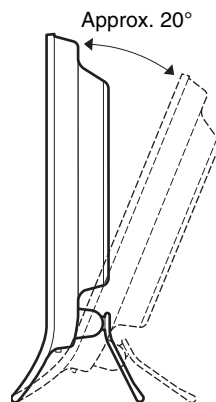

Grasp the lower sides of the LCD panel, then adjust screen tilt.

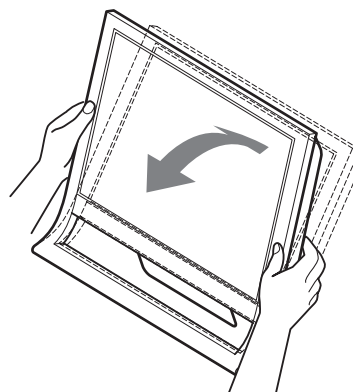

To use the display comfortably

This display is designed so that you can set it up at a comfortable viewing angle. Adjust the viewing angle of your display according to the height of the desk and chair, and so that light is not reflected from the screen to your eyes.

Note

When adjusting the screen tilt, make sure not to knock or drop the display off the desk.



Customizing Your Monitor

Before making adjustments

Connect the monitor and the computer, and turn them on. Wait for at least 30 minutes before making adjustments for the best result.



You can make numerous adjustments to your monitor using the on-screen menu.

Adjusting to the desired brightness

Pressing the  button, you can change the brightness of the screen. Each time you press the  button, the  mode changes as follows.

USER → HIGH → MIDDLE → LOW → USER ...

The brightness of the screen will decrease as the  mode setting changes from HIGH to LOW.

If you select USER, you can adjust the backlight level by pressing the / buttons, the same as when you select BACKLIGHT using the menu.







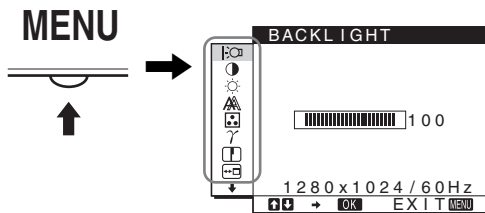

Only while the  mode is set to USER, are the BACKLIGHT, CONTRAST, and BRIGHTNESS items of the menu available (page 11).

If you select LOW, the power consumption is reduced (page 16).

Navigating the menu

Press the MENU button to display the main menu on your screen. See page 11 for more information on using the MENU button.



Use the / and OK buttons to select the icons in the above main menu illustration. The following **1** to **10** menu appears. Keep pressing  to scroll down until the icons in menu **9** and **10** appear. See page 11 for more information on using the / and OK buttons.

1 BACKLIGHT (page 11)

Select the BACKLIGHT menu to adjust the brightness of the backlight.

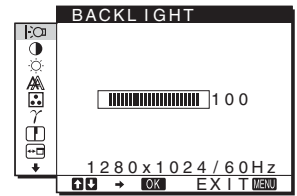

2 CONTRAST (page 12)

Select the CONTRAST menu to adjust the picture contrast.

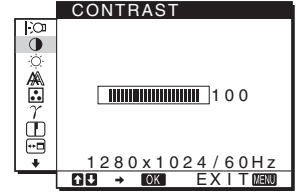

3 BRIGHTNESS (page 12)

Select the BRIGHTNESS menu to adjust the picture brightness (black level).

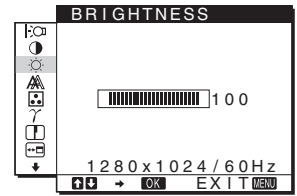

4 SCREEN (page 12)

Select the SCREEN menu to adjust the picture's sharpness (phase/pitch) or its centering (horizontal/vertical position).

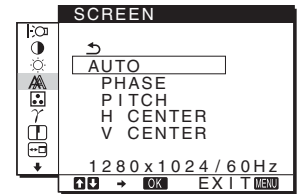

5 COLOR (page 13)

Select the COLOR menu to adjust the color temperature of the picture. This adjusts the tone of the screen. While COLOR is set to sRGB, you cannot adjust CONTRAST, BRIGHTNESS or GAMMA.

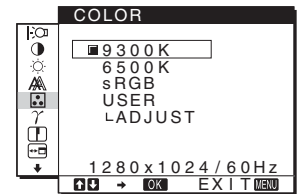

6 GAMMA (page 14)

Select the GAMMA menu to change the picture's color shade setting.

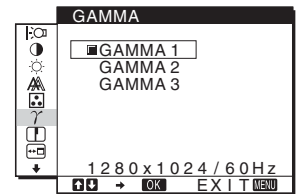

7 SHARPNESS (page 14)

Select the SHARPNESS menu to adjust to sharpen the edge of images.

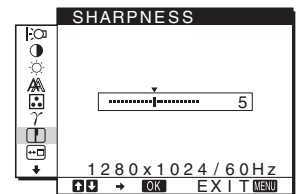

8 MENU POSITION  (page 14)

Select the MENU POSITION to change the on-screen menu position.

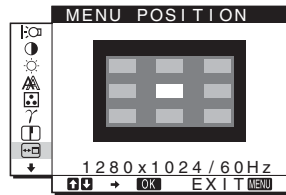



9 LANGUAGE  (page 15)

Select LANGUAGE to change the language used on menus or messages.



10 Other menus (page 15)

Set the following menu items.

- RESET 
- MENU LOCK 

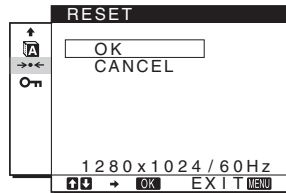

Using the MENU, ↓/↑, and OK buttons

1 Display the main menu.

Press the MENU button to display the main menu on your screen.

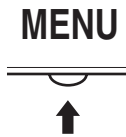

2 Select the menu you want to adjust.

Press the ↓/↑ buttons to display the desired menu. Press the OK button to select the menu item.

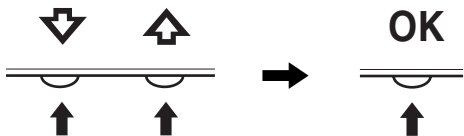

3 Adjust the menu.

Press the ↓/↑ buttons to make the adjustment, then press the OK button.

When you press the OK button, the setting is stored, then the display returns to the previous menu.

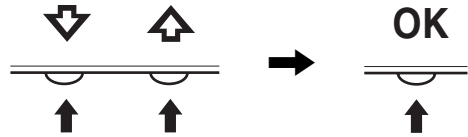

4 Close the menu.

Press the MENU button once to return to normal viewing. If no buttons are pressed, the menu closes automatically after about 45 seconds.

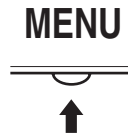

Resetting the adjustments

You can reset the adjustments using the RESET menu. See page 15 for more information on resetting the adjustments.

Adjusting the backlight (BACKLIGHT)

If the screen is too bright, adjust the backlight and make the screen easier to see.

Note

The backlight cannot be adjusted when the  mode is set to HIGH, MIDDLE, or LOW (page 10).

1 Press the MENU button.

The main menu appears on the screen.

2 Press the ↓/↑ buttons to select  (BACKLIGHT) and press the OK button.

The BACKLIGHT menu appears on the screen.

3 Press the ↓/↑ buttons to adjust the light level and press the OK button.

Adjusting the contrast (CONTRAST)

Adjust the picture contrast.

Note

The contrast cannot be adjusted when the  mode is set to HIGH, MIDDLE, or LOW (page 10).

- 1 Press the MENU button.**
The main menu appears on the screen.
- 2 Press the ↓/↑ buttons to select  (CONTRAST) and press the OK button.**
The CONTRAST menu appears on the screen.
- 3 Press the ↓/↑ buttons to adjust the contrast and press the OK button.**

Adjusting the black level of an image (BRIGHTNESS)

Adjust the picture brightness (black level).

Note

The brightness cannot be adjusted when the  mode is set to HIGH, MIDDLE, or LOW (page 10).

- 1 Press the MENU button.**
The main menu appears on the screen.
- 2 Press the ↓/↑ buttons to select  (BRIGHTNESS) and press the OK button.**
The BRIGHTNESS menu appears on the screen.
- 3 Press the ↓/↑ buttons to adjust the brightness and press the OK button.**

Adjusting the picture's sharpness and centering (SCREEN)

■ Automatic picture quality adjustment function

When the monitor receives an input signal, it automatically adjusts the picture's position and sharpness (phase/pitch), and ensures that a clear picture appears on the screen (page 16).

Note

While the automatic picture quality adjustment function is activated, only the  (power) switch will operate.



If the automatic picture quality adjustment function of this monitor seems to not completely adjust the picture You can make further automatic adjustment of the picture quality for the current input signal. (See AUTO below.)

If you still need to make further adjustments to the picture quality

You can manually adjust the picture's sharpness (phase/pitch) and position (horizontal/vertical position).

These adjustments are stored in memory and automatically recalled when the display receives the same input signal. These settings may have to be repeated if you change the input signal after reconnecting your computer.

■ Make further automatic adjustments to the picture quality for the current input signal (AUTO)

- 1 Press the MENU button.**
The main menu appears on the screen.
- 2 Press the ↓/↑ buttons to select  (SCREEN) and press the OK button.**
The SCREEN menu appears on the screen.
- 3 Press the ↓/↑ buttons to select AUTO and press the OK button.**
Make the appropriate adjustments of the screen's phase, pitch and horizontal/vertical position for the current input signal and store them.
- 4 Press the ↓/↑ buttons to select  and press the OK button.**
Return to the menu screen.

■ Adjust the picture's sharpness manually (PHASE/PITCH)

You can adjust the picture's sharpness as follows.

- 1 Set the resolution to 1280 × 1024 on the computer.**
- 2 Load the CD-ROM.**
- 3 Start the CD-ROM, select the region and model, and display the test pattern.**
For Windows
Click [Utility] → [Windows]/[Win Utility.exe].
For Macintosh
Click [Utility] → [Mac]/[Mac Utility].
- 4 Press the MENU button.**
The main menu appears on the screen.
- 5 Press the ↓/↑ buttons to select  (SCREEN) and press the OK button.**
The SCREEN menu appears on the screen.
- 6 Press the ↓/↑ buttons to select PHASE and press the OK button.**
The PHASE menu appears on the screen.
- 7 Press the ↓/↑ buttons until the horizontal stripes are at a minimum.**

Adjust so that the horizontal stripes are at a minimum.

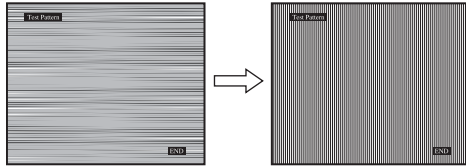

8 Press the OK button.

Return to the SCREEN menu.

If vertical stripes are observed over the entire screen, adjust pitch by the following steps.

9 Press the ↓/↑ buttons to select PITCH and press the OK button.

The PITCH menu appears on the screen.

10 Press the ↓/↑ buttons until the vertical stripes disappear.

Adjust so that the vertical stripes disappear.

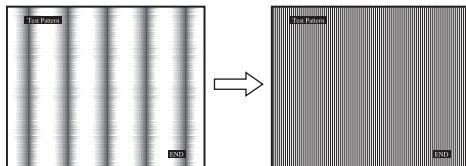

11 Click [END] on the screen to turn off the test pattern.

12 Press the OK button.

Return to the SCREEN menu.

13 Press the ↓/↑ buttons to select ↶ and press the OK button.

Return to the menu screen.

■ Adjust the picture's position manually (H CENTER/V CENTER)

If the picture is not in the center of the screen, adjust the picture's centering as follows.

1 Set the resolution to 1280 × 1024 on the computer.

2 Load the CD-ROM.

3 Start the CD-ROM, select the region and model, and display the test pattern.

For Windows

Click [Utility] → [Windows]/[Win Utility.exe].

For Macintosh

Click [Utility] → [Mac]/[Mac Utility].

4 Press the MENU button.

The main menu appears on the screen.

5 Press the ↓/↑ buttons to select  (SCREEN) and press the OK button.

The SCREEN menu appears on the screen.

6 Press the ↓/↑ buttons to select H CENTER or V CENTER and press the OK button.

The H CENTER or V CENTER menu appears on the screen.

7 Press the ↓/↑ buttons to center the test pattern in the screen.

8 Click [END] on the screen to turn off the test pattern.

9 Press the OK button.

Return to the SCREEN menu.

10 Press the ↓/↑ buttons to select ↶ and press the OK button.

Return to the menu screen.

Adjusting the color temperature (COLOR)

You can select the color level of the picture's white color field from the default color temperature settings.

Also, if necessary, you can fine tune the color temperature.

You can set the desired color temperature for each mode of the brightness of screen.

GB

1 Press the MENU button.

The main menu appears on the screen.

2 Press the ↓/↑ buttons to select  (COLOR) and press the OK button.

The COLOR menu appears on the screen.

3 Press the ↓/↑ buttons to select the desired color temperature and press the OK button.

Whites will change from a bluish hue to reddish hue as the temperature is lowered from 9300K (default setting) to 6500K.

While "USER" is selected for the brightness of screen, you can set the color temperature to "sRGB."

When you select "sRGB," the colors adjust to the sRGB profile. (The sRGB color setting is an industry-standard color space protocol designed for computer products.) If you select "sRGB," the color settings of your computer must be set to the sRGB profile.

Notes

- If a connected computer or other equipment is not sRGB-compliant, color cannot be adjusted to the sRGB profile.
- While COLOR is set to sRGB, you cannot adjust CONTRAST, BRIGHTNESS or GAMMA.

Fine tuning the color temperature (USER ADJUSTMENT)

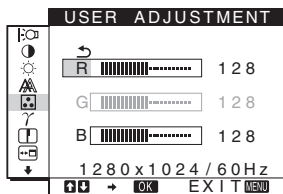

- 1 Press the **↓/↑** buttons to select **ADJUST** and press the **OK** button.

The USER ADJUSTMENT menu appears on the screen.

- 2 Press the **↓/↑** buttons to select **R (Red)** or **B (Blue)** and press the **OK** button. Then press the **↓/↑** buttons to adjust the color temperature and press the **OK** button.

Since this adjustment changes the color temperature by increasing or decreasing the R and B components with respect to G (green), the G component is fixed.

- 3 Press the **↓/↑** buttons to select **↶**, then press the **OK** button.

The new color setting is stored in memory for USER and automatically recalled whenever USER is selected.

The main menu appears on the screen.

Changing the gamma setting (GAMMA)

You can associate the picture's color shade on the screen with the picture's original color shade.

- 1 Press the **MENU** button.
The main menu appears on the screen.
- 2 Press the **↓/↑** buttons to select **γ (GAMMA)** and press the **OK** button.
The GAMMA menu appears on the screen.
- 3 Press the **↓/↑** buttons to select the desired mode and press the **OK** button.

Adjusting the sharpness (SHARPNESS)

Adjust to sharpen the edge of images, etc.

- 1 Press the **MENU** button.
The main menu appears on the screen.
- 2 Press the **↓/↑** buttons to select **⏏ (SHARPNESS)** and press the **OK** button.
The SHARPNESS menu appears on the screen.
- 3 Press the **↓/↑** buttons to adjust the sharpness and press the **OK** button.

Changing the menu's position (MENU POSITION)

You can change the menu position if it is blocking an image on the screen.

- 1 Press the **MENU** button.
The main menu appears on the screen.
- 2 Press the **↓/↑** buttons to select **⏏ (MENU POSITION)** and press the **OK** button.
The MENU POSITION menu appears on the screen.
- 3 Press the **↓/↑** buttons to select the desired position and press the **OK** button.
There are three positions each for the top, center and bottom of the screen.

Selecting the on-screen menu language (LANGUAGE)

You can change the language used on menus or messages displayed on this monitor.

- 1 Press the MENU button.**
The main menu appears on the screen.
- 2 Keep pressing the ↓ button until the icon of the desired option item appears.**
- 3 Press the ↓/↑ buttons to select  (LANGUAGE) and press the OK button.**
The LANGUAGE menu appears on the screen.
- 4 Press the ↓/↑ buttons to select a language and press the OK button.**
 - ENGLISH
 - FRANÇAIS: French
 - DEUTSCH: German
 - ESPAÑOL: Spanish
 - ITALIANO: Italian
 - NEDERLANDS: Dutch
 - SVENSKA: Swedish
 - РУССКИЙ: Russian
 - 日本語: Japanese
 - 中文: Chinese

Additional settings

You can adjust the following options:

- RESET →←
- MENU LOCK 

- 1 Press the MENU button.**
The main menu appears on the screen.
- 2 Keep pressing the ↓ button until the icon of the desired option item appears.**
- 3 Press the ↓/↑ buttons to select the desired option item and press the OK button.**
Adjust the selected option item according to the following instructions.





■ Resetting the adjustment data to the defaults

You can reset the adjustments to the default settings.

- 1 Press the ↓/↑ buttons to select →← (RESET) and press the OK button.**
The RESET menu appears on the screen.
- 2 Press the ↓/↑ buttons to select the desired mode and press the OK button.**
 - OK: To reset all of the adjustment data to the default settings. Note that the  (LANGUAGE) setting is not reset by this method.
 - CANCEL: To cancel resetting and return to the menu screen.

■ Locking the menus and controls

You can lock the control of buttons to prevent accidental adjustments or resetting.

- 1 Press the ↓/↑ buttons to select  (MENU LOCK) and press the OK button.**
The MENU LOCK menu appears on the screen.
- 2 Press the ↓/↑ buttons to select ON or OFF and press the OK button.**
 - ON: Only the  (power) switch will operate. If you attempt any other operation, the  (MENU LOCK) icon appears on the screen.
 - OFF: Set  (MENU LOCK) to OFF. If you set the  (MENU LOCK) item to ON, only this menu item can be selected.

Technical Features

Power saving function

This monitor meets the power-saving guidelines set by VESA, ENERGY STAR, and NUTEK. If the monitor is connected to a computer or video graphics board that is DPMS (Display Power Management Standard) compliant, the monitor will automatically reduce power consumption as shown below.

SDM-HS75

Power mode	Power consumption	⏻ (power) indicator
normal operation	45 W (max.)	green
active off* (deep sleep)**	1.0 W (max.)	orange
power off	1.0 W (max.)	off

SDM-HS95

Power mode	Power consumption	⏻ (power) indicator
normal operation	50 W (max.)	green
active off* (deep sleep)**	1.0 W (max.)	orange
power off	1.0 W (max.)	off

* When your computer enters the “active off” mode, the input signal is cut and NO INPUT SIGNAL appears on the screen. After 5 seconds, the monitor enters the power saving mode.

** “deep sleep” is the power saving mode defined by the Environmental Protection Agency.

Reducing the power consumption (|:☐ mode)

If you set the |:☐ mode to LOW by pressing the |:☐ button on the front of the monitor, the backlight level is reduced and the power consumption is reduced, too.

Press the |:☐ button several times until LOW appears.

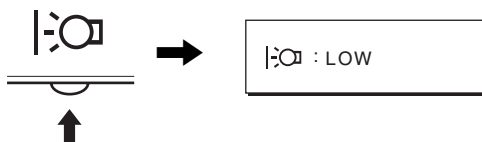

LOW appears on the screen and the backlight level is reduced. LOW automatically disappears after about 5 seconds.

Automatic picture quality adjustment function

When the monitor receives an input signal, it automatically adjusts the picture's position and sharpness (phase/pitch), and ensures that a clear picture appears on the screen.

The factory preset mode

When the monitor receives an input signal, it automatically matches the signal to one of the factory preset modes stored in the monitor's memory to provide a high quality picture at the center of the screen. If the input signal matches the factory preset mode, the picture appears on the screen automatically with the appropriate default adjustments.

If input signals do not match one of the factory preset modes

When the monitor receives an input signal that does not match one of the factory preset modes, the automatic picture quality adjustment function of this monitor is activated to ensure that a clear picture always appears on the screen (within the following monitor frequency ranges):

Horizontal frequency: 28–80 kHz

Vertical frequency: 48–75 Hz

Consequently, the first time the monitor receives input signals that do not match one of the factory preset modes, the monitor may take a longer time than normal to display the picture on the screen. This adjustment data is automatically stored in memory so that next time, the monitor will function in the same way as when the monitor receives the signals that match one of the factory preset modes.

If you adjust the phase, pitch, and picture position manually

For some input signals, the automatic picture quality adjustment function of this monitor may not completely adjust the picture position, phase, and pitch. In this case, you can set these adjustments manually (page 12). If you set these adjustments manually, they are stored in memory as user modes and automatically recalled whenever the monitor receives the same input signals.

Note

While the automatic picture quality adjustment function is activated, only the ⏻ (power) switch will operate.

Troubleshooting

Before contacting technical support, refer to this section.

On-screen messages

If there is something wrong with the input signal, one of the following messages appears on the screen. To solve the problem, see “Trouble symptoms and remedies” on page 18.

If **OUT OF RANGE** appears on the screen

This indicates that the input signal is not supported by the monitor’s specifications. Check the following items.

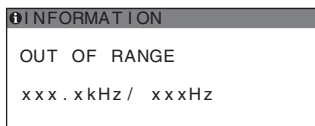

If **“xxx.x kHz/xxx Hz”** is displayed

This indicates that either the horizontal or vertical frequency is not supported by the monitor’s specifications. The figures indicate the horizontal and vertical frequencies of the current input signal.

If **“RESOLUTION > 1280 × 1024”** is displayed

This indicates that the resolution is not supported by the monitor’s specifications (1280 × 1024 or less).

If **NO INPUT SIGNAL** appears on the screen

This indicates that no signal is being input.

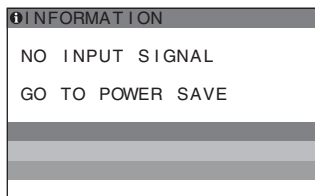

GO TO POWER SAVE

The monitor will enter the power saving mode after about 5 seconds from the time the message is displayed.



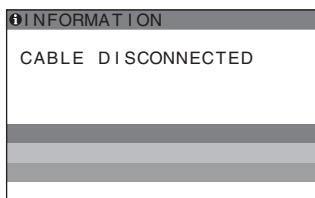

If **CABLE DISCONNECTED** appears on the screen



This indicates that the video signal cable has been disconnected.



Trouble symptoms and remedies

If a problem is caused by the connected computer or other equipment, please refer to the connected equipment's instruction manual.

Symptom	Check these items
No picture	
If the  (power) indicator is not lit, or if the  (power) indicator will not light up when the  (power) switch is pressed,	<ul style="list-style-type: none">• Check that the power cord is properly connected.
If CABLE DISCONNECTED appears on the screen,	<ul style="list-style-type: none">• Check that the video signal cable is properly connected and all plugs are firmly seated in their sockets (page 7).• Check that the video input connector's pins are not bent or pushed in.• A non-supplied video signal cable is connected. If you connect a non-supplied video signal cable, CABLE DISCONNECTED may appear on the screen before entering the power saving mode. This is not a malfunction.
If NO INPUT SIGNAL appears on the screen, or the  (power) indicator is orange,	<ul style="list-style-type: none">• Check that the video signal cable is properly connected and all plugs are firmly seated in their sockets (page 7).• Check that the video input connector's pins are not bent or pushed in. <p>■ Problems caused by a computer or other equipment connected, and not caused by the monitor</p> <ul style="list-style-type: none">• The computer is in the power saving mode. Try pressing any key on the keyboard or moving the mouse.• Check that your graphics board is installed properly.• Check that the computer's power is on.• Restart the computer.
If OUT OF RANGE appears on the screen,	<p>■ Problems caused by a computer or other equipment connected, and not caused by the monitor</p> <ul style="list-style-type: none">• Check that the video frequency range is within that specified for the monitor. If you replaced an old monitor with this monitor, reconnect the old monitor and adjust the computer's graphics board within the following ranges: Horizontal: 28–80 kHz Vertical: 48–75 Hz Resolution: 1280 × 1024 or less
If you are using Windows and replaced an old monitor with this monitor,	<ul style="list-style-type: none">• If you replaced an old monitor with this monitor, reconnect the old monitor and do the following. Select "SONY" from the "Manufacturers" list and select "SDM-HS75" or "SDM-HS95" from the "Models" list in the Windows device selection screen. If the model name of this monitor does not appear in the "Models" list, try "Plug & Play."
If using a Macintosh system,	<ul style="list-style-type: none">• If you use the Macintosh adapter (not supplied), check that the Macintosh adapter and the video signal cable are properly connected (page 7).
Picture flickers, bounces, oscillates, or is scrambled	<ul style="list-style-type: none">• Adjust the pitch and phase (page 12).• Try plugging the monitor into a different AC outlet, preferably on a different circuit. <p>■ Problems caused by a computer or other equipment connected, and not caused by the monitor</p> <ul style="list-style-type: none">• Check your graphics board manual for the proper monitor setting.• Confirm that the graphics mode (VESA, Macintosh 19" Color, etc.) and the frequency of the input signal are supported by this monitor. Even if the frequency is within the proper range, some graphics boards may have a sync pulse that is too narrow for the monitor to sync correctly.• Adjust the computer's refresh rate (vertical frequency) to obtain the best possible picture.

Symptom	Check these items
Picture is fuzzy	<ul style="list-style-type: none"> Adjust the brightness and contrast (page 12). Adjust the pitch and phase (page 12). <p>■ Problems caused by a computer or other equipment connected, and not caused by the monitor</p> <ul style="list-style-type: none"> Set the resolution to 1280 × 1024 on your computer.
Picture is ghosting	<ul style="list-style-type: none"> Eliminate the use of video cable extensions and/or video switch boxes. Check that all plugs are firmly seated in their sockets.
Picture is not centered or sized properly	<ul style="list-style-type: none"> Adjust the pitch and phase (page 12). Adjust the picture position (page 13). Note that some video modes do not fill the screen to the edges.
Picture is too small	<p>■ Problems caused by a computer or other equipment connected, and not caused by the monitor</p> <ul style="list-style-type: none"> Set the resolution to 1280 × 1024 on your computer.
Picture is dark	<ul style="list-style-type: none"> Adjust the brightness using the BRIGHTNESS menu (page 12). Adjust the backlight (page 11). Adjust the brightness using the  button (page 10). It takes a few minutes for the display to become bright after turning on the monitor.
Wavy or elliptical pattern (moire) is visible	<ul style="list-style-type: none"> Adjust the pitch and phase (page 12).
Color is not uniform	<ul style="list-style-type: none"> Adjust the pitch and phase (page 12).
White does not look white	<ul style="list-style-type: none"> Adjust the color temperature (page 13).
Monitor buttons do not operate ( appears on the screen)	<ul style="list-style-type: none"> If the menu lock is set to ON, set it to OFF (page 15).
The monitor turns off after a while	<p>■ Problems caused by a computer or other equipment connected, and not caused by the monitor</p> <ul style="list-style-type: none"> Set the computer's power saving setting to off.
Resolution displayed on the menu screen is incorrect	<ul style="list-style-type: none"> Depending on the graphics board setting, the resolution displayed on the menu screen may not coincide with the one set on the computer.

Displaying this monitor's information

While the monitor is receiving a video signal, press and hold the MENU button for more than 5 seconds until the information box appears.

Press the MENU button again to make the box disappear.

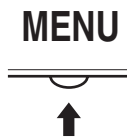

Example

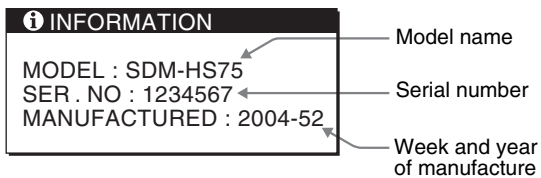

If any problem persists, call your authorized Sony dealer and give the following information:

- Model name: SDM-HS75 or SDM-HS95
- Serial number
- Detailed description of the problem
- Date of purchase
- Name and specifications of your computer and graphics board

Specifications

SDM-HS75

LCD panel	Panel type: a-Si TFT Active Matrix Picture size: 17.0 inch
Input signal format	RGB operating frequency* Horizontal: 28–80 kHz Vertical: 48–75 Hz
Resolution	Horizontal: Max.1280 dots Vertical: Max.1024 lines
Input signal levels	Analog RGB video signal 0.7 Vp-p, 75 Ω , positive SYNC signal TTL level, 2.2 k Ω , positive or negative (Separate horizontal and vertical)
Power requirements	100–240 V, 50–60 Hz, Max. 1.0 A
Power consumption	Max. 45 W
Operating temperature	5–35 °C
Dimensions (width/height/depth)	Display (upright): Approx. 388 × 382.5 × 139.2 mm (15 ¹ / ₄ × 15 × 5 ¹ / ₂ inches)
Mass	Approx. 5 kg (11 lb. ³ / ₈ oz.)
Plug & Play	DDC2B
Accessories	See page 7.

SDM-HS95

LCD panel	Panel type: a-Si TFT Active Matrix Picture size: 19.0 inch
Input signal format	RGB operating frequency* Horizontal: 28–80 kHz Vertical: 48–75 Hz
Resolution	Horizontal: Max.1280 dots Vertical: Max.1024 lines
Input signal levels	Analog RGB video signal 0.7 Vp-p, 75 Ω , positive SYNC signal TTL level, 2.2 k Ω , positive or negative (Separate horizontal and vertical)
Power requirements	100–240 V, 50–60 Hz, Max. 1.0 A
Power consumption	Max. 50 W
Operating temperature	5–35 °C
Dimensions (width/height/depth)	Display (upright): Approx. 435 × 418 × 146 mm (17 ¹ / ₈ × 16 ¹ / ₂ × 5 ³ / ₄ inches)
Mass	Approx. 6 kg (13 lb. 3 ⁵ / ₈ oz.)
Plug & Play	DDC2B
Accessories	See page 7.

- * Recommended horizontal and vertical timing condition
- Horizontal sync width duty should be more than 4.8% of total horizontal time or 0.8 μ s, whichever is larger.
 - Horizontal blanking width should be more than 2.5 μ sec.
 - Vertical blanking width should be more than 450 μ sec.

Design and specifications are subject to change without notice.