

IC Recorder

Operating Instructions

IC RECORDER

ICD-B10/B15

For the customers in the United States

Owner's Record

The model number is located at the rear and the serial number is located inside the battery compartment.

Record these numbers in the spaces provided below.

Refer to these numbers whenever you call upon your Sony dealer regarding this product.

Model No. _____ Serial No. _____

INFORMATION

This equipment has been tested and found to comply with the limits for a Class B digital device, pursuant to Part 15 of the FCC Rules. These limits are designed to provide reasonable protection against harmful interference in a residential installation. This equipment generates, uses, and can radiate radio frequency energy and, if not installed and used in accordance with the instructions, may cause harmful interference to radio communications.

However, there is no guarantee that interference will not occur in a particular installation. If this equipment does cause harmful interference to radio or television reception, which can be determined by turning the equipment off and on, the user is encouraged to try to correct the interference by one or more of the following measures:

- Reorient or relocate the receiving antenna.
- Increase the separation between the equipment and receiver.
- Connect the equipment into an outlet on a circuit different from that to which the receiver is connected.
- Consult the dealer or an experienced radio/TV technician for help.

This device complies with Part 15 of the FCC Rules. Operation is subject to the following two conditions: (1) This device may not cause harmful interference, and (2) this device must accept any interference received, including interference that may cause undesired operation.

You are cautioned that any changes or modifications not expressly approved in this manual could void your authority to operate this equipment.

Table of Contents

Before You Begin

What is an IC recorder?	4
Features	5

Getting Started

Step 1: Installing the Batteries	6
Step 2: Setting the Clock	8

Basic Operations

Recording Messages	10
Playing Back Messages	14
Playing Back the Specified Section Repeatedly — A-B Repeat	18
Erasing Messages	19

Editing Messages

Adding a Recording	21
Dividing a Message into Two/Combining Messages — Index Function	23
Moving Messages to a Different Folder — Move Function	26

Other Functions

Starting Recording at a Desired Time — Timer Recording	27
Playing Back a Message at a Desired Time with an Alarm	30
Preventing Accidental Operation — HOLD function	33
Selecting the Display Mode	34
Menu map	35
Changing the Settings	36

Additional Information

Precautions	37
Troubleshooting	38
Index to Parts and Controls	42
Specifications	45
Index	46

► Before You Begin

What is an IC recorder?

This IC recorder enables you to record and play back oral messages in the built-in IC memory.

● Recording

When a new message is recorded, it is automatically added after the last recorded messages.

Unlike with tape recorders, you do not need to worry about recording over previously recorded messages by mistake.

Since you do not need to search for the end of the last recording, you can start recording quickly whenever you wish.



● Playback

With this IC recorder, you can quickly locate the message you want to play back.

Reviewing the current recording is also very easy.

● Erasing

You can quickly erase unwanted messages with an easy operation. When a message is erased, the next message automatically advances, leaving no blank space.

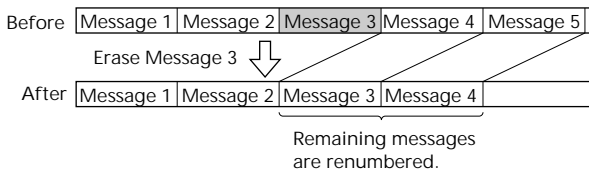

Features

- Maximum recording time ICD-B10: 63 min. (SP)/168 min. (LP)
ICD-B15: 127 min. (SP)/339 min. (LP)

This unit is suitable for recording long meetings or lectures.

- Possible of recording up to 99 messages in each of 3 folders (ICD-B10)/5 folders (ICD-B15)
- Alarm function (page 30)
You can start playing back a desired message with an alarm on a desired date and time.
- Timer recording function (page 27)
You can start recording automatically on a desired date and time.
- Index function (page 23)
You can add an index at the desired point during recording or playback to divide a message into two.
You can also combine messages by erasing the index.
- Repeat play function (page 16, 18)
This unit can play back one message or the selected section repeatedly.
- Easy search function (page 17)
You can quickly search for the point (10 seconds ahead or 3 seconds back) and start playback.
- Playback speed control (page 16)
You can play back messages rapidly or slowly . This is useful when playing back a long recording such as a meeting.
- Advanced VOR function (page 13)
- Overwrite and additional recording functions (page 21)
You can overwrite after the desired point on a recorded message or add a new recording to a previously recorded message.
- External microphone jack (page 13)

Step 1: Installing the Batteries

- 1 Slide and lift the battery compartment lid.

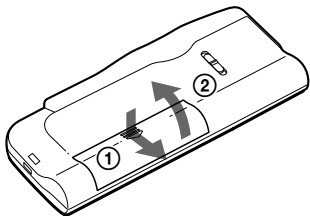

- 2 Insert two LR03 (size AAA) alkaline batteries with correct polarity, and close the lid.

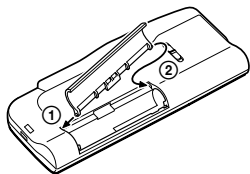
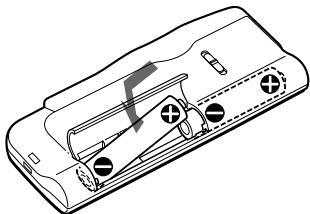



If the battery compartment lid is accidentally detached, attach it as illustrated.

Clock setting display appears when you insert batteries for the first time, or when you insert batteries after the unit has been without batteries for a certain period of time. Please refer to Steps 2 to 4 in “Step 2: Setting the Clock” on pages 8 and 9 to set the date and time.

Replacing the batteries

The battery indicator on the display window shows the battery condition.

When  flashes, replace the batteries with new ones.

When  flashes, the batteries are exhausted and the unit will stop operation.

Battery life*

With continuous use, approx. 7.5 hours (SP)/15 hours (LP) of recording or approx. 6 hours (SP)/8 hours (LP) of playback is possible.

* Using Sony alkaline batteries LR03 (SG)

* When playing back through the internal speaker with VOL control at around 4

The battery life may shorten depending on the operation of the unit.

Notes

- Do not use manganese batteries for this unit.
- When you replace the batteries, insert the new ones within 3 minutes after you removed the exhausted ones. Otherwise, the display may show the clock setting display or incorrect date and time when you re-insert the batteries. In this case, set the date and time again.
The recorded messages and alarm setting, however, will remain.
- When replacing the batteries, be sure to replace both batteries with new ones.
- Do not charge dry batteries.
- When you are not going to use the unit for a long time, remove the batteries to prevent damage from battery leakage and corrosion.

Note on the "ACCESS" message

When you insert the batteries, "ACCESS" may appear on the display window.

Do not remove the batteries while this message is displayed.

If the unit is required to process excessive amount of data, "ACCESS" may be displayed for an extended period of time. This is not a malfunction of the unit.

Wait until the message disappears before starting operation.

Step 2: Setting the Clock

You need to set the clock to use the alarm or timer setting function. Clock setting display appears when you insert batteries for the first time, or when you insert batteries after the unit has been without batteries for a certain period of time. In this case, proceed from step 2.

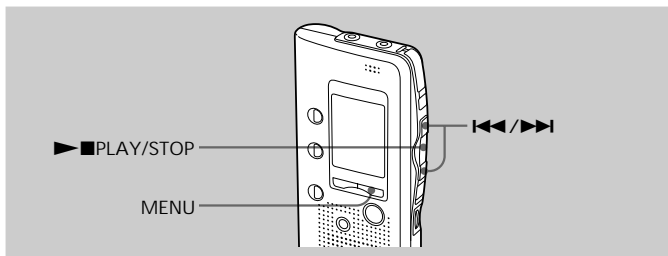

1 Press MENU to enter the menu mode.

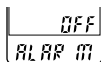

2 Display the clock setting display.

① Press once to display "SET DATE".

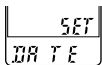

② Press PLAY/STOP. The year digits will flash.

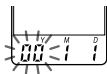

3 Set the date.

① Press or to select the digits of the year.

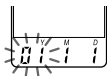

② Press PLAY/STOP. The month digits will flash.

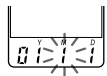

③ Set the month and day in sequence, then press PLAY/STOP. The hour digits will flash.

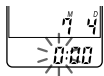

4 Set the time.

- ① Press **◀◀** or **▶▶** to select the digits of the hour.

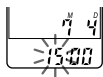

- ② Press **▶■**PLAY/STOP. The minute digits will flash.

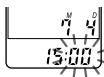

- ③ Set the minute.

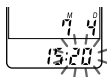

- 5 Press **▶■**PLAY/STOP at the time signal. The display will return to "SET DATE".

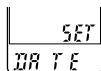

- 6 Press MENU to exit the menu mode.



Tip

This unit does not have a power on/off switch. The display is shown at all times.

Recording Messages

You can record up to 99 messages in each of three folders (A, B, or C) for ICD-B10 or five folders (A, B, C, D or E) for ICD-B15. Since a newly recorded message is automatically added behind the last recorded message, you can start recording quickly without searching for the end of the last recording.

e.g.

Message 1	Message 2	Newly recorded message	Blank space
-----------	-----------	------------------------	-------------

Note

Before making a long recording, be sure to insert new batteries and check the battery indicator (page 7).

1 Select the folder.

Press FOLDER repeatedly to display the folder in which you wish to record messages.

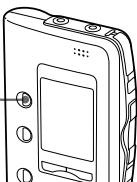

Current folder

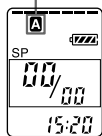

2 Start recording.

① Press ●REC/STOP.

Remaining memory indicator

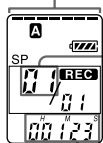

Current message number

Counter display*

10GB

② Speak to the built-in microphone.

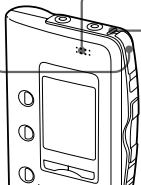

OPR indicator (lights in red during recording.)

You do not need to keep pressing ●REC/STOP while recording.

* The display selected with the DISPLAY button (page 34) appears.

3

Stop recording.

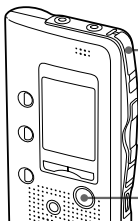

Press ●REC/STOP again.
The unit stops at the beginning
of the current recording.

■STOP

If you do not change the folder after you stop recording, the next time you record you will record in the same folder.

To stop recording

You can also stop recording by pressing ■STOP instead of ●REC/STOP.

To pause recording

To	Do this
pause recording*	Press ■PAUSE. During recording pause, the OPR indicator flashes in red and "PAUSE" flashes in the display window.
release pause and resume recording	Press ■PAUSE or ●REC/STOP. Recording resumes from that point. (To stop recording after pausing recording, press ■STOP.)

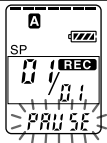

* 15 minutes after you pause recording, recording pause is automatically released and the unit goes into the stop mode.

Continued

Recording Messages (continued)

To select the microphone sensitivity

See page 36.

Maximum recording time

With the ICD-B10, you can record for up to 63 minutes in SP (standard play) mode and 168 minutes in LP (long play) mode. If you record messages in a mixture of SP and LP modes, the recordable time varies from 63 to 168 minutes.

With the ICD-B15, you can record for up to 127 minutes in SP (standard play) mode and 339 minutes in LP (long play) mode. If you record messages in a mixture of SP and LP modes, the recordable time varies from 127 to 339 minutes.

The unit is factory-set to SP mode. To change the recording mode, see page 36. You can check the remaining amount of recording time by selecting the remaining recording time display mode. See page 34.

Remaining memory indication

During recording, the remaining memory indicator decreases one by one.

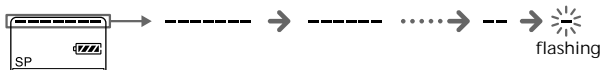

When the remaining time of recording reaches 5 minutes, the last one of the indication flashes. When the remaining time of recording reaches 1 minute, the selected display mode (page 34) and "REMAIN" will flash one after the other in the display window. When the memory is full, recording automatically stops and "FULL" will flash in the display window with an alarm sound. To continue recording, first erase some of the messages (page 19).

Various Ways of Recording

Starting recording automatically in response to the sound
— Advanced VOR function

When the VOR (voice operated recording) function is set to ON (page 36), recording starts when the recorder detects sound and stops when no sound is heard.

Note

VOR function is affected by the sound around you. Set the microphone sensitivity (SENS) to either HI (high) or LO (low) (see page 36). If recording is not satisfactory after you have changed the microphone sensitivity, or for important recording, set VOR to OFF.

Recording with an external microphone or from other equipment

Connect a plug-in-power type microphone or other equipment to the MIC (PLUG IN POWER) jack.

When you connect an external microphone, the built-in microphone is automatically cut off. When a plug-in-power type microphone is connected, power is automatically supplied to the microphone from the IC recorder.

Adding a recording

To add a recording to a previously recorded message or to add an overwrite recording during playback, see pages 21 and 22.

Playing Back Messages

When playing back a previously recorded message, start from Step 1.
When playing back a message you have just finished recording, start from Step 3.

1 Select the folder.

Press FOLDER repeatedly to display the folder you wish to play back.

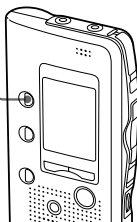

Current folder

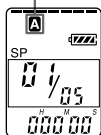

2 Select the message number.

Press ◀◀ or ▶▶ to display the desired message number.

◀◀: for smaller message number

▶▶: for larger message number

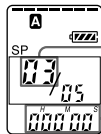
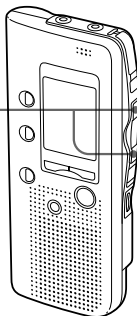

Selected message number

Counter display*

* The display selected with the DISPLAY button (page 34) appears.

3

Start playback.

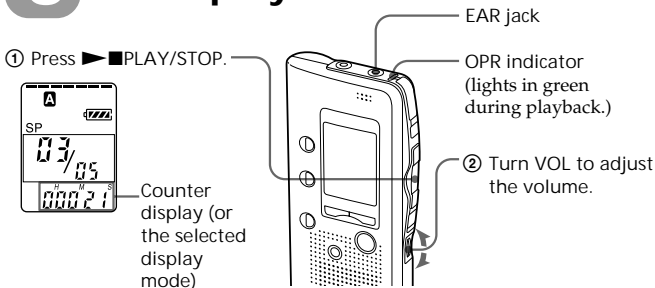

After playing back one message, the unit stops at the beginning of the next message.

When the last message on a folder has been played back, the unit stops at the beginning of the last message.

For private listening

Connect an earphone or headphones (not supplied) to the EAR jack. The built-in speaker will be automatically disconnected. If you plug in headphones, you will get monaural output from both left and right channels.

To stop playback

To	Do this
stop at the beginning of the current message	Press ■ STOP.
stop at the current position	Press ▶■ PLAY/STOP. (Playback Pause function)* To resume playback from that point, press ▶■ PLAY/STOP again.

* You can also pause playback by pressing **||**PAUSE instead of **▶■**PLAY/STOP. The OPR indicator will flash in green. After an hour, the unit goes into the stop mode at the current position.

Playing back all messages in a folder continuously

— Continuous Play

See page 36.

Continued

Playing Back Messages (continued)

Other operations

To	Do this
go back to the beginning of the current message**	Press ◀◀ once.***
skip to the next message**	Press ▶▶ once.***
go back to previous messages/skip to succeeding messages	Press ◀◀ or ▶▶ repeatedly.*** (During stop mode, keep the button pressed to skip the messages continuously.)
play back rapidly or slowly	Set PLAY SPEED to FAST or SLOW. The messages will be played back about 30% faster or 15% slower than normal.
play messages with normal speed	Set PLAY SPEED to NORMAL.

** If you have set a bookmark on the message, the unit stops at the bookmark.

*** These operations are for when EASY-S is set to OFF. For operations when EASY-S is set to ON, see page 17.

Various Ways of Playback

Playing back a message repeatedly — Repeat Play

During playback, press ▶■PLAY/STOP for more than one second. "↺" will be displayed and the selected message will be played back repeatedly.

To resume normal playback, press ▶■PLAY/STOP again. To stop playback, press ■STOP.

Playing the beginning of each message — Scanning Play

During stop mode, press ▶■PLAY/STOP for more than one second. "SCAN" will be displayed in the display window and the first 5 seconds of each message in the selected folder will be played back.

When you find the desired message, press ▶■PLAY/STOP. The message will be played back until the end.

Searching forward/backward during playback (Cue/Review)

To search forward, keep ►► pressed during playback and release the button at the point you wish to resume playback.

To search backward, keep ◄◄ pressed during playback and release the button at the point you wish to resume playback.

The unit searches at slow speed (unit of 4 seconds) with playback sound. It is useful when checking one word forward or behind.

If you keep ►► or ◄◄ pressed, the unit starts searching at higher speed. Between messages the unit pauses for 2 seconds.

During cue/review, the counter will be displayed, regardless of the display mode setting (page 34).

You can cue or review during playback pause. The unit goes back into playback pause at the point you release ►► or ◄◄.

Tip

When fast playback is done to the end of the last message, "END" flashes for 5 seconds and the OPR indicator lights up in green. (You cannot hear the playback sound.) If you keep ◄◄ pressed while "END" is flashing, the messages are played back rapidly, and normal playback will start at the point you release the button.

When "END" stops flashing and the OPR indicator goes off, the unit will stop at the beginning of the last message.

If the last message is long and you wish to start playback at a later part of the message, keep ►► pressed to play back the message to the end and then press ◄◄ while "END" is flashing to go back to the desired point. (For messages other than the last one, go to the beginning of the next message and play backward to the desired point.)

Locating quickly the point you wish to start playback (Easy Search)

When EASY-S is set to ON (page 36), you can quickly locate the point you wish to start playback by pressing ►► or ◄◄ repeatedly during playback or playback pause.

You can go back approx. 3 seconds by pressing ◄◄ once, or advance approx 10 seconds by pressing ►► once. This function is useful when locating a desired point in a long recording.

Playing Back the Specified Section Repeatedly — A-B Repeat

While playing back a message, you can set the start (A) and end (B) points for a section you wish to play repeatedly.

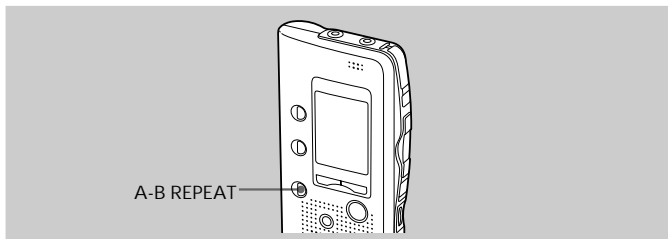

- 1 During playback, press A-B REPEAT briefly.
The starting point (A) of the section you wish to play repeatedly is set. "A-B B" flashes.

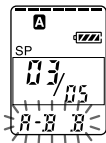

- 2 During playback, press A-B REPEAT briefly.
The finishing point (B) of the section is set.
"A-B" is displayed and the specified section is played back repeatedly.

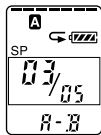

To resume normal playback

Press **▶■**PLAY/STOP.

To stop A-B Repeat playback

Press **■**STOP.

Notes

- You cannot set A-B Repeat for a section that overlaps two or more messages.
- If you do not set the finishing point (B), the finishing point is automatically set at the end (or the beginning) of the message.

Erasing Messages

You can erase the recorded messages one by one or all messages in a folder at a time.

Note that once a recording has been erased, you cannot retrieve it.

Erasing messages one by one

When a message is erased, the remaining messages will advance and renumbered so that there will be no space between messages.

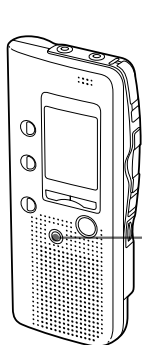
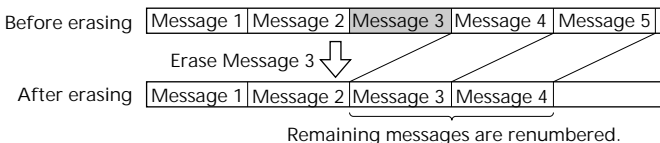

- ① Press ERASE while playing back the message you want to erase or press ERASE for more than 1 second during stop mode. A beep will sound and the message number and "ERASE" will flash while the first and last 5 seconds of the message are played back 10 times.

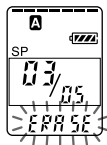

- ② Press ERASE while the message is being played back. The message is erased and the remaining messages will be renumbered. (For example, if you erase Message 3, Message 4 will be renumbered as Message 3. When erasing is completed, the unit will stop at the beginning of the following message.)

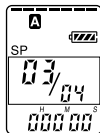

To cancel erasing
Press ■STOP before step ②.

Continued

Erasing Messages (continued)

To erase other messages

Repeat steps ① and ②.

To erase a message partially

First divide the message by adding an index (see page 23) and then follow the steps on page 19 to erase the message.

Erasing all messages in a folder

e.g.

Folder A



Folder B

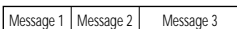
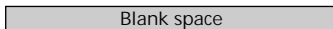
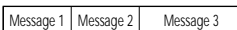

- ① Press FOLDER to select the folder you want to erase.

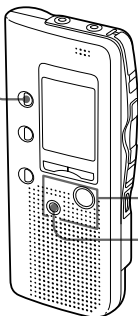

- ② While pressing ■STOP, press ERASE for more than 1 second. "ALL ERASE" will flash for 10 seconds.

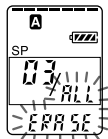

- ③ While the display is flashing, press ERASE.

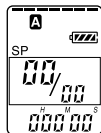

To cancel erasing

Press ■STOP before step ③.

Adding a Recording

Adding a Recording to a Previously Recorded Message

You can add a recording to the message being played back.

The added recording will be placed after the current message and counted as a part of the message.

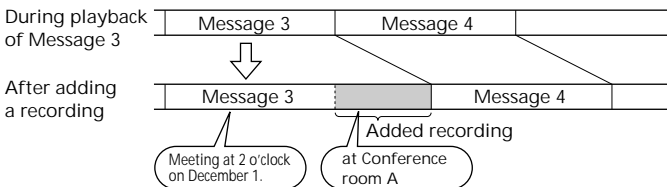
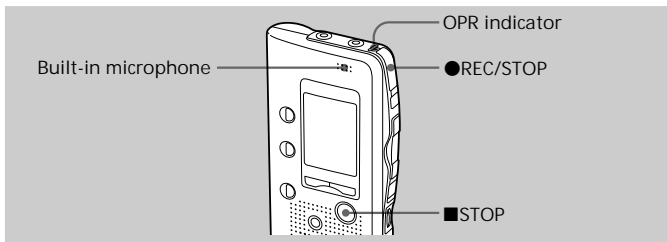

- 1 During playback, press ●REC/STOP for more than 1 second.
The REC indicator appears and “ADD” flashes three times on the display window.
The OPR indicator will turn red.
The new recording will be added at the end of the current message.

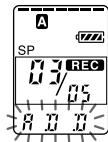

- 2 Press ●REC/STOP or ■STOP to stop the recording.

Continued

Adding an Overwrite Recording during Playback

You can add an overwrite recording after the selected point in a recorded message. The part of the message after the selected point is deleted.

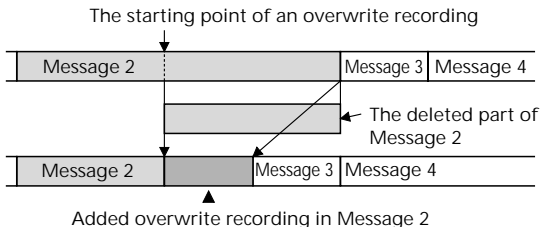

- 1 During playback, press ●REC/STOP briefly.
“OVER” flashes on the display window and the OPR indicator flashes in red.
- 2 Press ●REC/STOP to start recording.
“REC” is displayed and the OPR indicator turns red.
- 3 Press ■STOP to stop the recording.

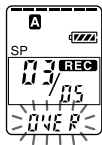

Notes

- The added message will be recorded in the same recording mode (SP or LP; see page 36) as the original message, regardless of the current recording mode setting.
- You cannot overwrite if the remaining memory of the IC recorder is not enough. For details, see “Troubleshooting” on page 38.

Dividing a Message into Two/ Combining Messages — Index Function

You can divide a message by adding an index, or combine messages by erasing the index.

While recording/playing back messages, you can add an index (see below). In stop mode, you can erase the index (see page 25).

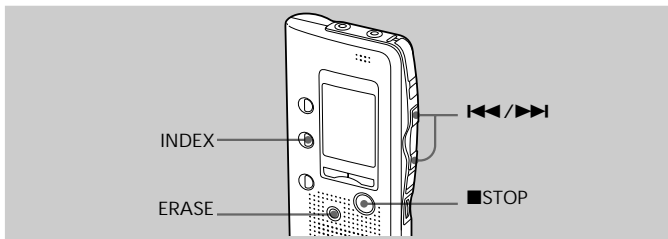

Dividing a Message by Adding an Index

You can add an index to a message during recording or playback. By dividing a message, you can easily find the point you want to play back when you make a long recording such as a meeting.

When you add an index, the message numbers will increase as follows.

Before adding an index

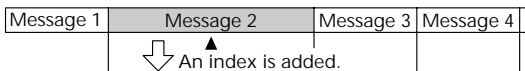

After adding an index

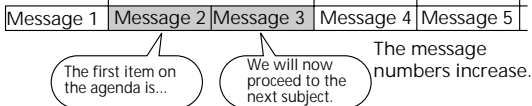

Continued

Dividing a Message into Two/Combining Messages — Index Function (continued)

To mark an index during recording

While recording a message, press INDEX at the point you want to divide.

The new message number flashes three times at the point you pressed INDEX. The message will be divided in two messages; however, the messages will be recorded without a break.

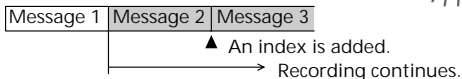
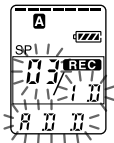

Tip

You can add an index during recording pause (page 13).

To add an index during playback

While playing back a message, press INDEX at the point you want to divide.

The message is divided in two and the new message number flashes three times.

An index mark is added and the following index numbers will increase by one.

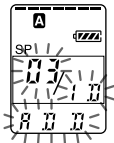

Tip

You can add an index after you have paused playback with **PAUSE** (page 15).

To play the message you marked with an index

Press **◀◀** or **▶▶** to display the message number as the divided messages each have message numbers.

To play the divided messages continuously

Select "ON" for "CONT" as described in "Changing the Settings" on page 36.

Combining messages by erasing the index

You can combine two messages into one by erasing the index.

Message 1	Message 2	Message 3	Message 4	Message 5
	↓	▲ An index is erased.		
Message 1	Message 2	Message 3	Message 4	

The message numbers decrease.

In stop mode, follow the steps below:

- 1 Press ◀◀ or ▶▶ to display the number of the second of the two messages you want to combine.
- 2 While pressing INDEX, press ERASE for more than 1 second.
“ID ERASE” will flash for 10 seconds.
- 3 Press ERASE while the display is flashing.
The two messages are combined into one and the messages will be renumbered as in the illustration above.

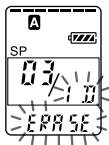

To cancel erasing

Press ■STOP before step 3.

Notes

- After combining messages by erasing an index, the latter message's alarm setting will be deleted.
- Due to the recording system of an IC recorder, you may not be able to add or delete an index in some cases (page 41).

Moving Messages to a Different Folder — Move Function

You can move the recorded messages to another folder.

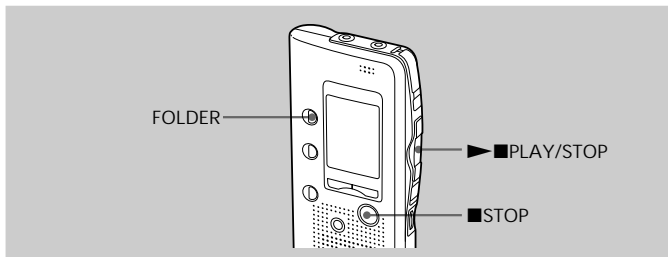

Example: Moving Message 3 in Folder A to Folder C

- 1 Play back the message you want to move.



- 2 While playing back the message, press FOLDER to flash the indication of the folder to which you want to move the message (C in this case).
The first and last 5 seconds of the message will be played back 10 times, while the folder indication and "MOVE" flash.

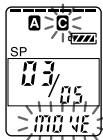

- 3 Press ►■PLAY/STOP.

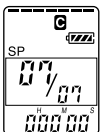

To cancel moving the message(s)
Press ■STOP before step 3.

(Example: when Folder C had 6 messages)

Note

The move function does not duplicate a message in another folder. When you move a message to another folder, the one in the previous folder will be deleted.

Starting Recording at a Desired Time — Timer Recording

You can start recording at a desired time.

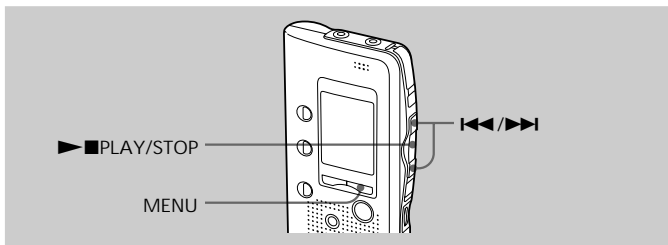

1 Display the timer setting display.

- ① Press MENU.

The unit enters the menu mode and "ALARM" will be displayed.

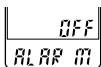

- ② Press ◀◀ or ▶▶ repeatedly to display "TIMER" and press ▶■PLAY/STOP. "OFF" starts to flash.



Note

The timer cannot be set if the clock has not been set .

- ③ Press ◀◀ or ▶▶ to flash "ON".



- ④ Press ▶■PLAY/STOP.

"START" is displayed for one second, and then "DATE" will flash in the display window.



Continued

Starting Recording at a Desired Time — Timer Recording (continued)

2 Set the recording start date.

- to start recording on a desired date
 - ① Press **▶■**PLAY/STOP while "DATE" is flashing.
 - ② Press **◀◀** or **▶▶** to select the year digits and press **▶■**PLAY/STOP.
 - ③ Select the month and day digits in the same way.

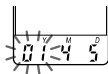

- to record once a week
Press **◀◀** or **▶▶** to select the day of the week.



- to record at the same time every day
Press **◀◀** or **▶▶** to select "DAILY" and press **▶■**PLAY/STOP.



3 Set the recording start time.

- ① Press **◀◀** or **▶▶** to select the hour digits and press **▶■**PLAY/STOP.
- ② Press **◀◀** or **▶▶** to select the minute digits and press **▶■**PLAY/STOP.

"END" is displayed for one second, and then the hour digits of the recording end will flash in the display window.

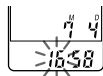

4 Repeat Step 3 to set the recording end time.

5 Select the recording mode.

Press **◀◀** or **▶▶** to select "SP" or "LP" and press **▶■**PLAY/STOP.



6 Press MENU to exit the menu mode.

The display will return to normal display and "⌚" is displayed.

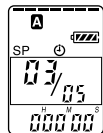

At the set time, recording starts automatically.

"⌚" flashes on the display window during recording.

When the recording ends, the unit will stop automatically at the beginning of the newly recorded message.

To stop the timer recording

Press ■STOP.

To change the timer setting

Press ◀◀ or ▶▶ in Step 2, 3 or 4 on page 28 to change the year, month, day or time and press ▶■PLAY/STOP.

To cancel the timer recording setting

Select "OFF" in Steps 1-③ on page 27 and press ▶■PLAY/STOP.

Notes

- You cannot set the timer to record more than one message.
- When the timer recording starts, the recording mode selected in Step 5 is automatically selected. When the recording ends, the recording mode is reset to the initial setting.
- Make sure that the remaining recording time is long enough for the timer recording. You cannot set the timer if the length of the timer recording exceeds the remaining recording time. However, in the case of recording once a week or everyday, you can set the timer if the remaining recording time is longer than the first recording and for the second or later recording, timer recording stops when there is no more remaining time on the IC recorder.
- If 99 messages have been recorded in the selected folder or the memory is full, timer recording will not start.
- If the timer is set to start recording before 23:59 and to end recording after 0:00, the recording will stop the next day.
- If the timer start time comes during alarm playback, playback will stop and the timer recording starts.
- When the timer recording start time comes during operation other than recording, the operation stops and the timer recording starts. When the timer recording start time comes during recording, the recording continues and the timer recording will not start.

Playing Back a Message at a Desired Time with an Alarm

You can sound an alarm and start playback of a selected message at a desired time. You can have the message played back at a desired date, once every week, or the same time everyday.

You can also sound the alarm without playing back a message.

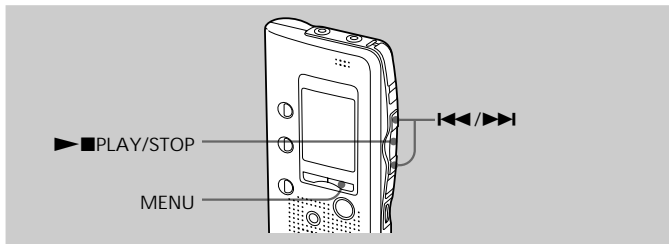

- 1 Select the message you wish to play back.

(See Steps 1 and 2 on page 14.)



- 2 Press MENU.

"ALARM OFF" will be displayed.

(If "ALARM ON" is displayed, the alarm has been set.)



Note

The alarm cannot be set if the clock has not been set or no message has been recorded in the selected folder.

- 3 Set the alarm setting to ON.

① Press ►■.



② Press ◀◀ or ▶▶ to flash "ON".

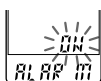

③ Press ►■.

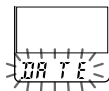

4 Set the alarm date.

- to play back on a desired date

- ① Press **▶■** while "DATE" is flashing.
- ② Press **◀◀** or **▶▶** to select the year digits and press **▶■**.

- ③ Select the month and day digits in the same way.



- to play back once a week
Press **◀◀** or **▶▶** to select the day of the week and press **▶■**.
- to play back at the same time every day
Press **◀◀** or **▶▶** to select "DAILY" and press **▶■**.

5 Set the alarm time.

- ① Press **◀◀** or **▶▶** to select the hour digits and press **▶■**.
- ② Select the minute digits and press **▶■**.

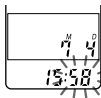
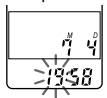

- 6 Press **◀◀** or **▶▶** to select "B-PLAY" (playback will start with an alarm) or "B-ONLY" (only an alarm will sound).

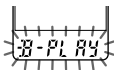

- 7 Press **▶■** PLAY/STOP.
The setting has been completed.

- 8 Press MENU to exit the menu mode.
The display returns to the normal display.
"(●)" is displayed when the number of the message with alarm setting is selected.

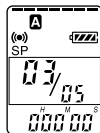

Continued

Playing Back a Message at a Desired Time with an Alarm (continued)

At the set time, the alarm will sound for about 10 seconds and the selected message will be played back. (If "B-ONLY" was selected in Step 6, only the alarm will sound.)

When the playback ends, the unit will stop automatically at the beginning of that message.

To listen to the same message again

Press ►■PLAY/STOP. The same message will be played back from the beginning.

To stop the alarm before the playback starts

Press ■STOP while the alarm sound is heard. You can stop even when the HOLD function is activated.

To cancel the alarm setting

Press ◀◀ or ▶▶ to flash "OFF" in Step 3 on page 30 and press ►■PLAY/STOP.

To change the alarm date and time

Follow Steps 1 to 3 on page 30. When the alarm date is displayed, follow Steps 4 to 7 on page 31 to change the alarm date and time.

Notes

- If you try to set the alarm to play back a message at a previously set time on another message, "PRE SET" will be displayed, preventing new settings.
- If the alarm time comes while another message is being played back with an alarm, the playback stops and the new message will be played back.
- If the timer recording start time comes during alarm playback, the playback stops and the timer recording will start.
- If the alarm time comes during recording, alarm will sound after the recording is finished and "Ⓜ" will flash.
- If more than one alarm time comes during recording, only the first message will be played back.
- When the alarm time comes when the unit is in the menu mode, alarm will sound and the menu mode will be cancelled.
- If you erase the message you set the alarm to play back, the alarm setting will be cancelled.
- If you add an index to the message you set the alarm to play back, playback will stop at the index.
- If you erase the index on the message you set the alarm to play back, the alarm setting will be cancelled.
- You can adjust the playback volume with the VOL control.
- If the alarm time comes during erasing, alarm will sound for 10 seconds after the erasing is finished and playback begins.
- Alarm setting will not be cancelled when the alarm playback finishes. To cancel alarm setting, see above.

Preventing Accidental Operation — HOLD function

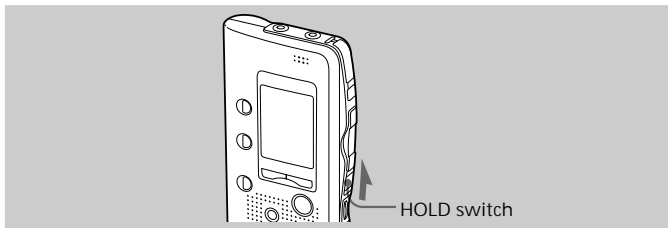

Slide the HOLD switch in the direction of the arrow. "HOLD" will flash three times, indicating that all the functions of the buttons are locked.

To cancel the HOLD function, simply slide the HOLD switch in the opposite direction.

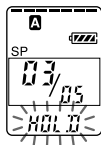

Note

When the HOLD function is activated during recording, cancel the HOLD function first to stop recording.

Tip

Even if the HOLD function is activated, you can stop the alarm playback. To stop the alarm or playback, press **■**STOP.

Selecting the Display Mode

You can select the display mode for the stop, recording and playback modes. (If the unit is left unoperated for more than 3 seconds in the stop mode, the display will show the current time, regardless of the display mode setting.)

Each time you press DISPLAY, the display mode will change as shown below:

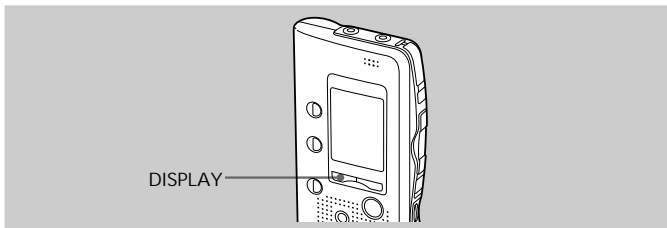

Counter:

Elapsed playback/
recording
time in one
message

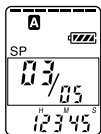

Remaining recording time:

The remaining recording
time is displayed
during recording or in
stop mode.
During playback, the
remaining time of the
message is displayed.

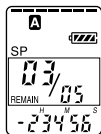

Recorded time:
The date and
time the current
message was
recorded.
(If the clock has
not been set,
"- :-" will be
displayed.)

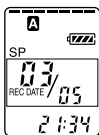

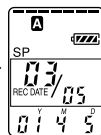

Recorded date:
The date the current
message was recorded.
(If the clock has not
been set,
"- -Y- -M- -D" will be
displayed.)

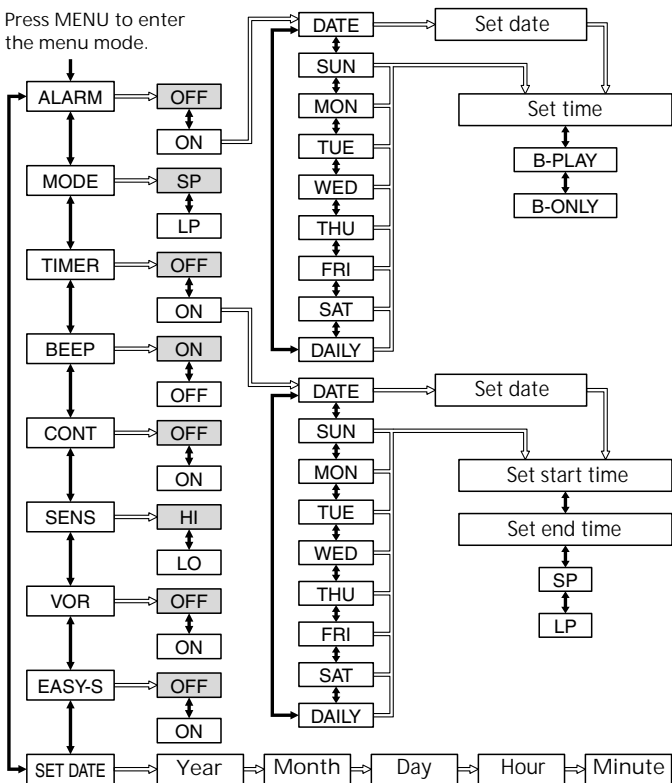

Menu map

Press MENU to enter the menu mode.



 : Initial setting

 : Press **▶■**PLAY/STOP to go to the next step.

 : Press **◀◀** or **▶▶** to select.

Changing the Settings

Follow the menu map on page 35.

- ① Press MENU to enter the menu mode.
- ② Press **◀◀** or **▶▶** to select the item and press **▶■** PLAY/STOP.
- ③ Press **◀◀** or **▶▶** to select the mode and press **▶■** PLAY/STOP to fix the setting.

● Alarm setting (ALARM)

See page 30.

● Timer recording (TIMER)

See page 27.

● Recording mode (MODE)

SP: You can record for up to 63 minutes (ICD-B10)/127 minutes (ICD-B15) with better sound.

LP: You can record for up to 168 minutes (ICD-B10)/339 minutes (ICD-B15).

● Beep sound (BEEP)

BEEP ON: A beep will sound to indicate that operation has been accepted.

BEEP OFF: No beep sound will be heard except for the alarm and timer.

● Continuous Play (CONT)

CONT ON: You can play back all messages in a folder continuously.

CONT OFF: Playback stops at the end of each message.

● Microphone sensitivity (SENS)

HI (high): To record at a meeting or in a quiet and/or spacious place.

LO (low): To record for dictation or in a noisy place.

● VOR (Voice Operated Recording) (VOR)

VOR ON: Recording starts when the recorder detects sound and stops when no sound is heard.

VOR OFF: The recorder keeps recording whether sound is heard or not.

● Easy search (EASY-S)

EASY-S ON: You can go back for approx. 3 seconds with a press of the **◀◀** button, or advance for approx. 10 seconds with a press of the **▶▶** button.

EASY-S OFF: You can go back to the beginning of the current message with a press of the **◀◀** button, or advance to the beginning of the next message with a press of the **▶▶** button.

● Clock setting (SET DATE)

See page 8.

Precautions

On power

- Operate the unit only on 3 V DC. Use two LR03 (size AAA) alkaline batteries.

On safety

- Do not operate the unit while driving, cycling or operating any motorized vehicle.

On handling

- Do not leave the unit in a location near heat sources, or in a place subject to direct sunlight, excessive dust or mechanical shock.
- Should any solid object or liquid fall into the unit, remove the batteries and have the unit checked by qualified personnel before operating it any further.

On noise

- Noise may be heard when the unit is placed near an AC power source, a fluorescent lamp or a mobile phone during recording or playback.
- Noise may be recorded when an object, such as your finger, etc., rubs or scratches the unit during recording.

On maintenance

- To clean the exterior, use a soft cloth slightly moistened in water. Do not use alcohol, benzine or thinner.

Keep personal credit cards using magnetic coding or spring-wound watches, etc., away from the unit to prevent possible damage from the magnet used in the speaker.

If you have any questions or problems concerning your unit, please consult your nearest Sony dealer.

Backup recommendations

To avoid potential risk of data loss caused by accidental operation or malfunction of the IC recorder, we recommend that you save a backup copy of your recorded messages on a tape recorder or to a computer, etc.

Troubleshooting

Before taking the unit for repair, check the following sections. Should any problem persist after you have made these checks, consult your nearest Sony dealer.

Symptom	Remedy
The unit does not operate.	<ul style="list-style-type: none">•The batteries have been inserted with incorrect polarity.•The batteries are weak.•The buttons are locked with the HOLD switch. (If you press any button, "HOLD" will flash three times.)
No sound comes from the speaker.	<ul style="list-style-type: none">•The earphone or headphones are plugged in.•The volume is turned down completely.
"FULL" is displayed and you cannot start recording.	<ul style="list-style-type: none">•The memory is full. Erase some of the messages. See page 19.•99 messages have been recorded in the selected file. Select another file or erase some of the messages. See page 19.
You cannot overwrite.	<ul style="list-style-type: none">•The remaining memory is too short. The overwritten part will be deleted after the overwriting part finishes recording. Therefore, you can only overwrite within the remaining recording time.
Noise is heard.	<ul style="list-style-type: none">•An object, such as your finger, etc., accidentally rubbed or scratched the unit during recording so that noise was recorded.•The unit was placed near an AC power source, a fluorescent lamp or a mobile phone during recording or playback.•Plug of the connected microphone was dirty when recording. Clean the plug.•Earphone/headphones plug is dirty. Clean the plug.

Symptom	Remedy
Recording level is low.	•“LO”is selected in the SENS mode. Select “HI” (see page 36).
Recording is interrupted.	•The advanced VOR function (page 13) is activated. Select “OFF” in the VOR mode.
Recording level is unstable (when recording music, etc.)	•This unit is designed to automatically adjust the recording level when recording meetings, etc., and is not suitable for music recording.
Playback speed is too fast or too slow.	•Set the PLAY SPEED selector to “NORMAL.” See page 16.
“--:--” is displayed.	•You have not set the clock (see page 8).
“--Y--M--D” or “--:--” is displayed on the REC DATE display.	•The date of recording will not be displayed if you recorded the message when the clock was not set.
“PRE SET” is displayed and you cannot set the alarm or timer.	•You cannot set the alarm or timer at a date and time previously set on another message.
The back light of the display window does not illuminate (ICD-B15 only).	•The effect of the back light of the display window may be reduced in a bright location.
The battery life is short.	•The battery life may shorten depending on the operation of the unit.
The unit does not operate correctly.	•Take out the batteries and insert them again.

Please note that recorded messages may be erased during service or repair work.

Continued

Error messages

Error message	Cause/Remedy
"PRE SET"	<ul style="list-style-type: none">You set the alarm to play back a message or set the timer to start recording at a date and time previously set on another message. Change the alarm or timer recording setting.
"BACK-D"	<ul style="list-style-type: none">You set the alarm or time recording when the time is already past. Check it and set the appropriate date and time.
"NO ERASE"	<ul style="list-style-type: none">You cannot erase an index to combine messages of different modes.
"NO DATA"	<ul style="list-style-type: none">The selected folder does not have any messages. You cannot set the alarm, etc. because of this.
"SET DATE"	<ul style="list-style-type: none">If you do not set date and time, you cannot make alarm or time recording setting. To set date and time, see page 8.
"ID FULL"	<ul style="list-style-type: none">When there are already 99 messages in the selected folder or the remaining memory of the IC recorder is short, you cannot add an index. Erase some messages before adding an index.
"FULL"	<ul style="list-style-type: none">The remaining memory of the IC recorder is too short. Erase some messages before recording.
"ACCESS"	<ul style="list-style-type: none">You inserted the batteries. Wait until the message disappears before starting operation.

System limitations

There are some system limitations of the IC recorder. Troubles as mentioned below are not malfunctions of the unit.

Symptom	Cause/Remedy
You cannot record messages up to the maximum recording time.	<ul style="list-style-type: none">• If you record messages in a mixture of SP and LP modes, the recordable time varies from the maximum SP mode recording time to the maximum LP recording time.• If there are a number of messages shorter than the minimum recording unit (Approx. 16 seconds in SP mode and approx. 42 seconds in LP mode), they are still counted as 16 seconds or 42 seconds, so the remaining recording time may decrease by more than the actual length of the messages.• Even when each message is longer than the minimum recording unit, if the length of each message cannot be divided by the minimum recording unit, the remaining recording time may decrease by more than the total length of the messages.• The sum of the number on the counter (elapsed recording time) and the remaining recording time may be less than the unit's maximum recording time (page 12).
You cannot add an index.	<ul style="list-style-type: none">• You cannot add an index in a folder which has 99 messages.• If you add or erase indexes frequently, the unit may become unable to add indexes.
You cannot erase the indexes.	<ul style="list-style-type: none">• You cannot erase an index to combine different recording mode (SP/LP) messages.• If you add or erase indexes frequently, the unit may become unable to erase indexes.

Index to Parts and Controls

Refer to the pages indicated in parentheses for details.

Main unit

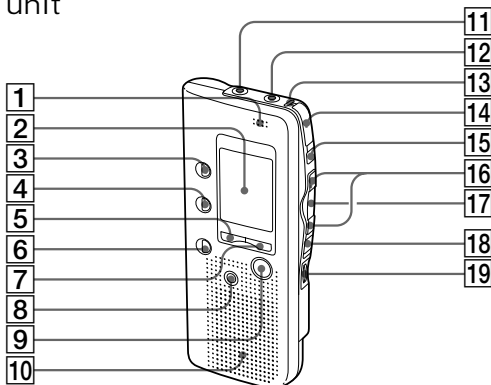

- | | |
|--|--|
| 1 MIC (built-in microphone) (10) | 14 ●REC (record) /STOP button (10, 21) |
| 2 Display window (44) | 15 ■■ PAUSE button (11, 15) |
| 3 FOLDER button (10, 14) | 16 ◀◀REVIEW/▶▶CUE (fast backward, review/fast forward, cue●selection of menu mode) button (8, 14, 16, 17, 23, 25, 27, 30, 35, 36) |
| 4 INDEX button (23) | 17 ▶■PLAY/STOP ●EXECUTE (play/stop●enter) button (8, 15, 16, 18, 26, 27, 30, 35, 36) |
| 5 DISPLAY button (34) | 18 HOLD switch (33) |
| 6 A-B REPEAT button (18) | 19 VOL (volume) control (15) |
| 7 MENU button (8, 27, 30, 35, 36) | |
| 8 ERASE button (19) | |
| 9 ■STOP button (11, 15) | |
| 10 Speaker | |
| 11 MIC (PLUG IN POWER) jack (13) | |
| 12 EAR (earphone) jack (15) | |
| 13 OPR (operation) indicator (10, 15) | |

Rear

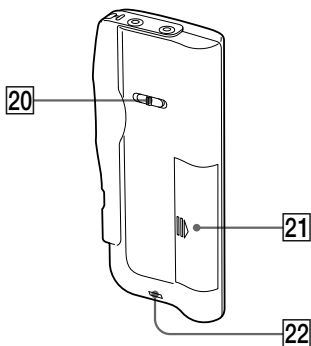

- 20** PLAY SPEED selector (16)
- 21** Battery compartment (6)
- 22** Hook for handstrap (not supplied)

Continued

Display window

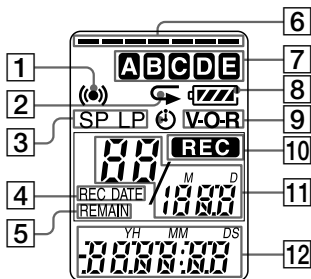

- 1** Alarm indicator (32)
- 2** Repeat play indicator (16)
- 3** Recording mode indication (36)
- 4** REC DATE (recorded date) indication (34)
- 5** REMAIN indicator (34)
- 6** Remaining memory indicator (12)
- 7** Folder indication (10, 14) (For ICD-B10, folders **D** and **E** do not appear.)
- 8** Remaining battery indicator (7)
- 9** VOR (voice operated recording) indicator (13)
- 10** REC (recording) indicator (10)
- 11** Selected message number (10, 14)/Mode indication of the menu (ON, OFF, etc.) (8, 20, 24, 27, 30, 35)
- 12** Counter /Remaining time indication /Recording date and time indication / Current time indication (15:30, etc.) (34)/Menu indication /Messages (ERASE, HOLD, etc.)

Note

The effect of the back light of the display window may be reduced in a bright location (ICD-B15 only).

Specifications

Recording media	Built-in flash memory, Monaural recording
Recording time	ICD-B10: 63 minutes (SP)/168 minutes (LP) ICD-B15: 127 minutes (SP)/339 minutes (LP)
Frequency response	SP: 250 Hz - 7,300 Hz LP: 300 Hz - 3,500 Hz
Speaker	approx. 3.2 cm (1 ⁵ / ₁₆ in.) dia.
Power output	300 mW
Input/Output	<ul style="list-style-type: none">• Earphone jack (minijack) for 16 - 300 ohms earphone/headphones• Microphone jack (minijack, monaural) Plug in power Minimum input level 0.6 mV 3 kilohms or lower impedance microphone
Playback speed control	FAST +30%, SLOW -15%
Power requirements	Two LR03 (size AAA) alkaline batteries: 3 V DC
Dimensions (w/h/d) (not incl. projecting parts and controls)	44.5 × 105.3 × 14.0 mm (1 ¹³ / ₁₆ × 4 ¹ / ₄ × ⁹ / ₁₆ in.)
Mass (incl. batteries)	68 g (2.4 oz)
Optional accessories	Electret Condenser Microphone ECM-Z60, ECM-T115 Earphone MDR-ED228LP, MDR-E818LP Connecting cord RK-G64

Your dealer may not handle some of the above listed optional accessories. Please ask the dealer for detailed information.

Design and specifications are subject to change without notice.

Index

- A**
A-B repeat 18
Accidental operation 33
Add, index 23
Add, recording 21
Advanced VOR 13
Alarm 30
- B**
Battery 6
Beep 36
Built-in microphone 10
- C**
Clock setting 8
Connecting external microphone 13
Connecting other equipment 13
Continuous playback 36
Counter display 34
Cue 17
- D**
Display window 44
Display mode 34
- E**
Easy search 17
Erase, index 25
Erase, messages 19
Error messages 40
External microphone 13
- F, G**
Folder 10, 14
- H**
Hold 33
- I, J, K**
IC memory 4
Index 23
- L**
LP mode 36
- M, N**
Menu 8, 27, 30, 35, 36
Menu map 35
Message, erasing 19
Message, move 26
Message, playing back 14
Message, recording 10
Message number 10, 14, 23
Microphone, built-in 10
Microphone, external 13
Microphone, connecting 13
Microphone sensitivity 12, 36
Move 26
- O**
Overwrite recording 22
- P, Q**
Play back continuously 36
Playback 14
Playback Pause function 15
Playback speed 16
Plug in power 13

R	
Recorded date	34
Recording	10
Recording mode	36
Remaining memory	10, 12
Remaining recording time	34
Repeat play	16
Review	17

S	
Scanning play	16
Search backward	17
Search forward	17
SP mode.	36

T, U	
Timer recording	27

V, W, X, Y, Z	
Volume control	15
VOR	13, 36

<http://www.world.sony.com/>