

SONY

Model: KDL-46XBR9

Description: LCD TV

Dimensions: 43 $\frac{1}{8}$ " 28 $\frac{5}{8}$ " 13"

(WHD): 43 $\frac{1}{8}$ " 25 $\frac{7}{8}$ " 3 $\frac{3}{8}$ " w/o stand

Weight: 43.9 lb

Carton Dimensions: 53 $\frac{1}{4}$ " 30 $\frac{7}{8}$ " 8 $\frac{3}{8}$ " (WHD):

Power requirements: 120V AC 60HZ

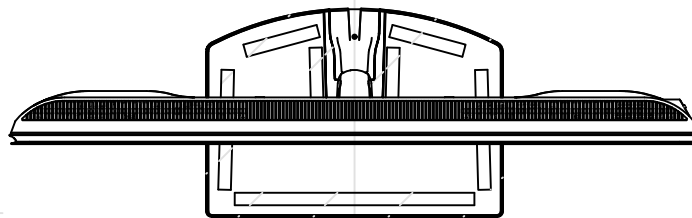
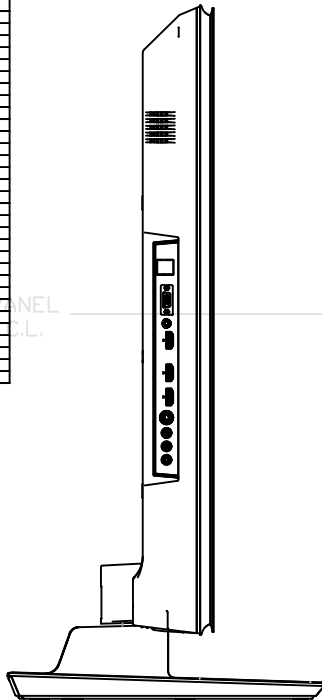
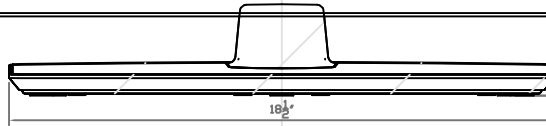

Top

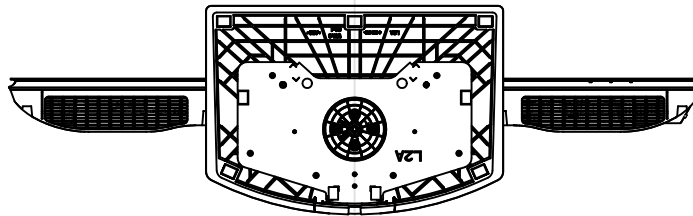

Bottom

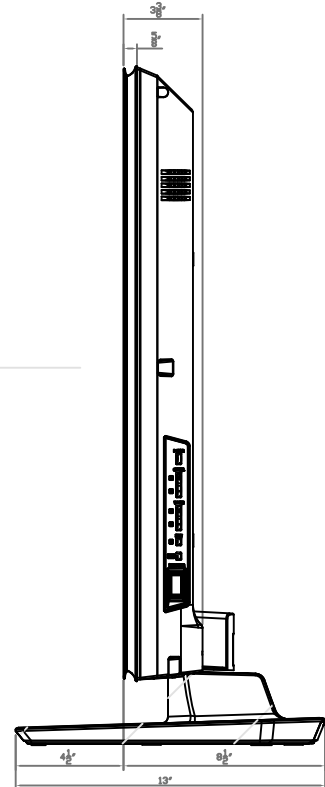

NOTE:

WHERE THERE ARE CLOSE TOLERANCES INVOLVED IN CABINET BUILDING OR APPLICATIONS WHICH REQUIRE A GREAT DEGREE OF PRECISION, WE RECOMMEND THAT THE PRODUCT ITSELF BE USED TO MAKE THE ACTUAL MEASUREMENTS. SONY WILL NOT BE HELD RESPONSIBLE FOR INACCURACIES IN THE DESIGN OR MANUFACTURE OF ENCLOSURES.

Consumer Integrated Systems - Park Ridge, New Jersey 07656 - Fax (201)930-7891 - www.sony.com/dn

Features and specifications subject to change without notice. Non-Metric weights and measurements are approximate.

SONY

Model: KDL-46XBR9

Description: LCD TV

Dimensions: 43 $\frac{1}{8}$ " 28 $\frac{5}{8}$ " 13"

(WHD): 43 $\frac{1}{8}$ " 25 $\frac{7}{8}$ " 3 $\frac{3}{8}$ " w/o stand

Weight: 43.9 lb

Carton Dimensions: 53 $\frac{1}{4}$ " 30 $\frac{7}{8}$ " 8 $\frac{3}{8}$ " (WHD):

Power requirements: 120V AC 60HZ

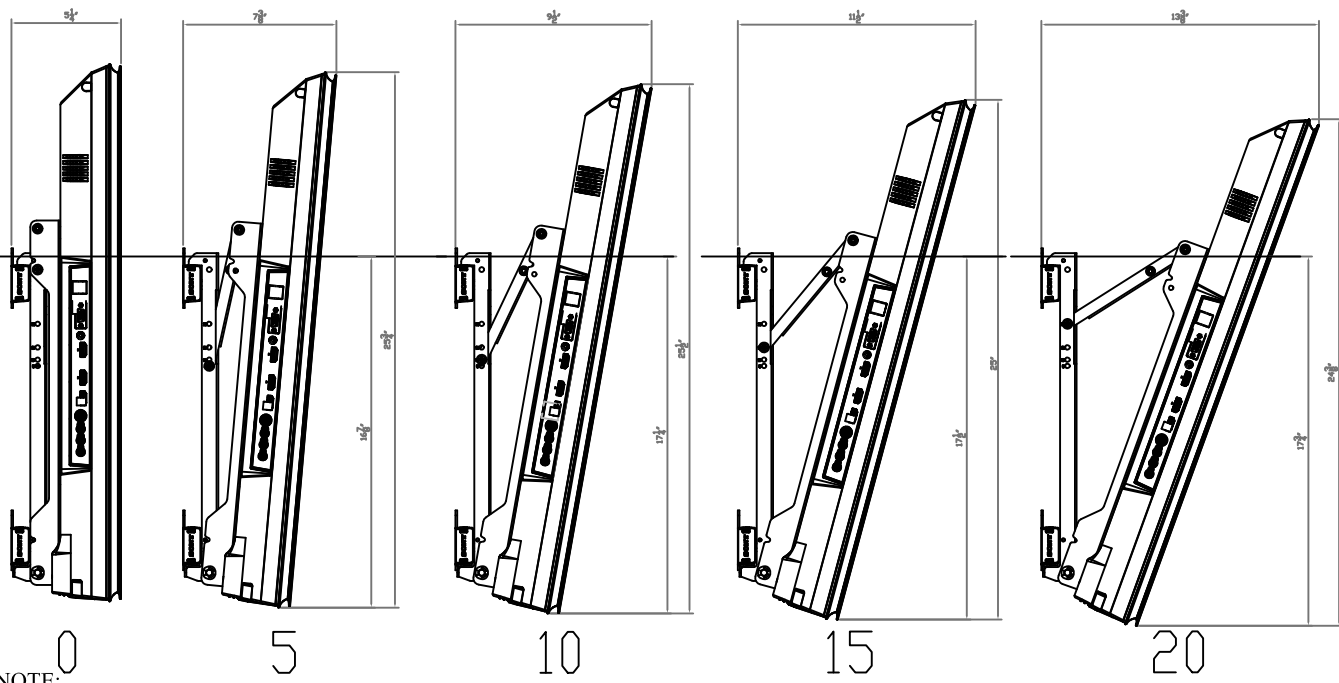
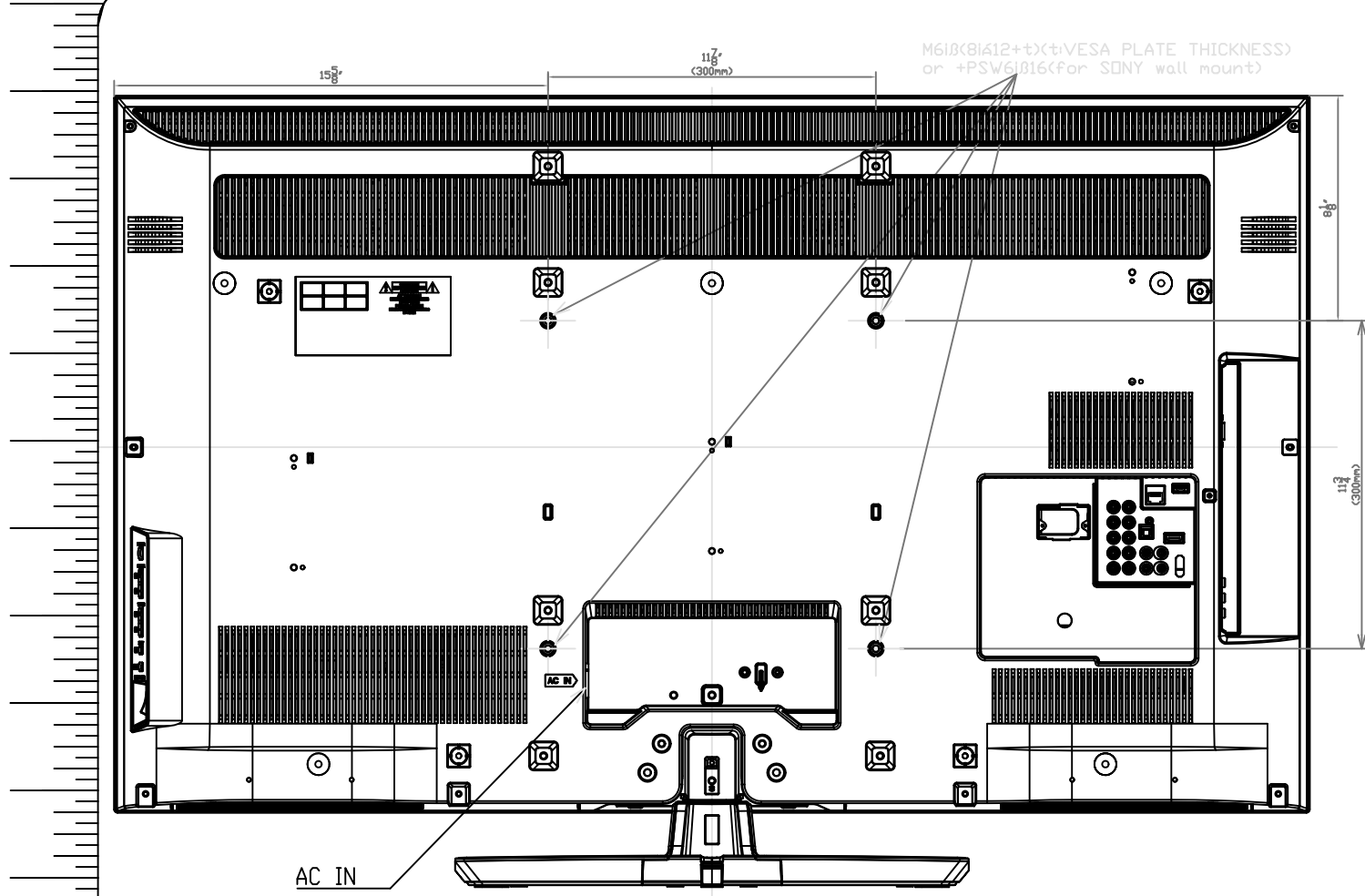

NOTE:

WHERE THERE ARE CLOSE TOLERANCES INVOLVED IN CABINET BUILDING OR APPLICATIONS WHICH REQUIRE A GREAT DEGREE OF PRECISION, WE RECOMMEND THAT THE PRODUCT ITSELF BE USED TO MAKE THE ACTUAL MEASUREMENTS. SONY WILL NOT BE HELD RESPONSIBLE FOR INACCURACIES IN THE DESIGN OR MANUFACTURE OF ENCLOSURES.

Consumer Integrated Systems - Park Ridge, New Jersey 07656 - Fax (201)930-7891 - www.sony.com/dh

Features and specifications subject to change without notice. Non-Metric weights and measurements are approximate.

SONY

Model: KDL-46XBR9

Description: LCD TV
Dimensions: 43 $\frac{1}{4}$ " 28 $\frac{5}{8}$ " 13"
(WHD): 43 $\frac{1}{8}$ " 25 $\frac{7}{8}$ " 3 $\frac{3}{8}$ " w/o stand
Weight: 43.9 lb

Carton Dimensions: 53 $\frac{1}{4}$ " 30 $\frac{7}{8}$ " 8 $\frac{3}{8}$ "
(WHD):
Power requirements: 120V AC
60HZ

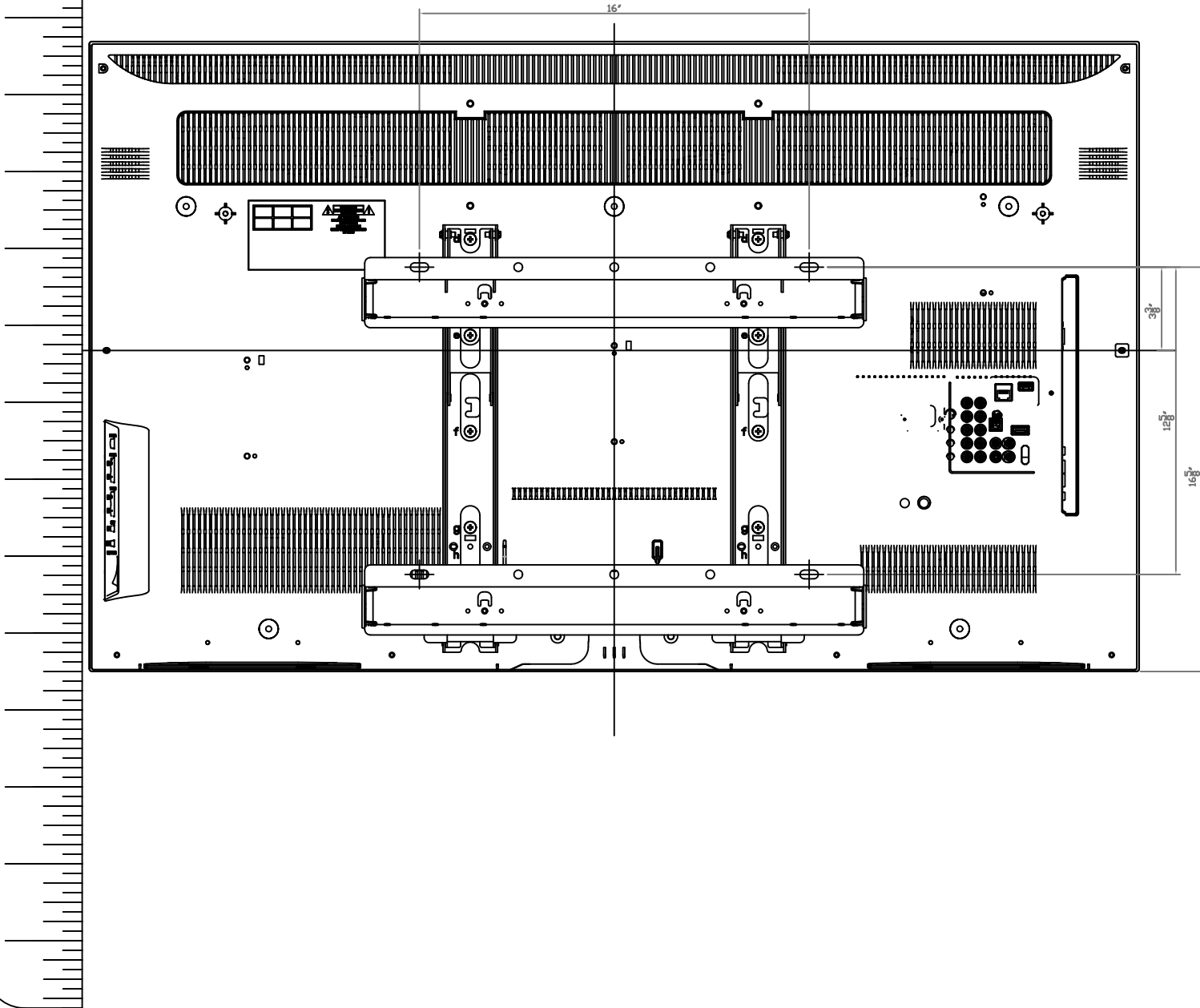

NOTE:

WHERE THERE ARE CLOSE TOLERANCES INVOLVED IN CABINET BUILDING OR APPLICATIONS WHICH REQUIRE A GREAT DEGREE OF PRECISION, WE RECOMMEND THAT THE PRODUCT ITSELF BE USED TO MAKE THE ACTUAL MEASUREMENTS. SONY WILL NOT BE HELD RESPONSIBLE FOR INACCURACIES IN THE DESIGN OR MANUFACTURE OF ENCLOSURES.

Consumer Integrated Systems - Park Ridge, New Jersey 07656 - Fax (201)930-7891 - www.sony.com/dn

Features and specifications subject to change without notice. Non-Metric weights and measurements are approximate.