

SONY

Model: KDL-60EX500

Description: LCD TV
Dimensions: 57 $\frac{3}{8}$ " 35 $\frac{7}{8}$ " 15 $\frac{1}{4}$ "
(WHD): 57 $\frac{3}{8}$ " 34 $\frac{3}{8}$ " 4 $\frac{3}{4}$ " w/o stand
Weight: 95.2 lb

Carton Dimensions: tbd
(WHD):
Power requirements: 120V AC
60HZ

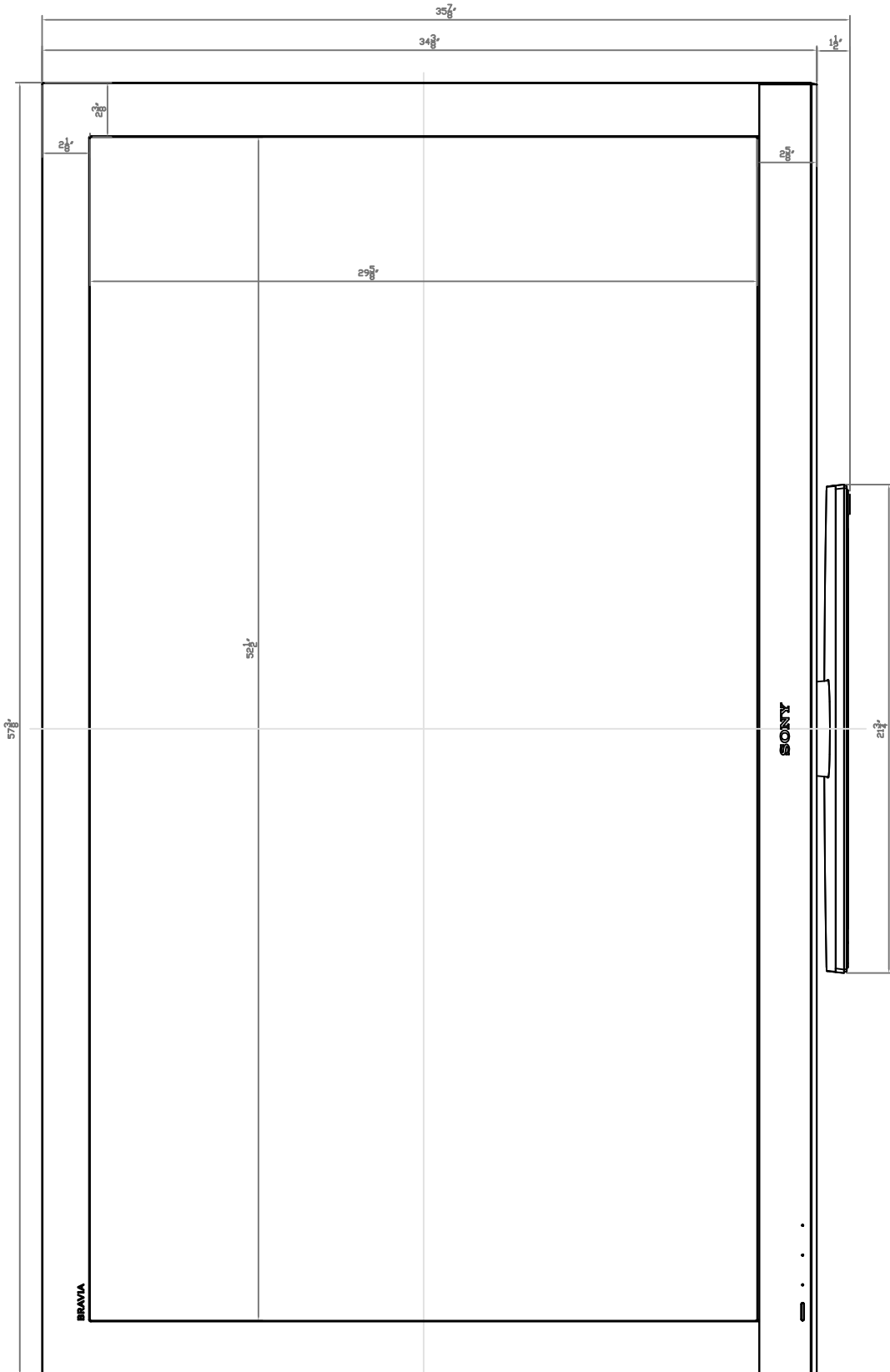

NOTE:

WHERE THERE ARE CLOSE TOLERANCES INVOLVED IN CABINET BUILDING OR APPLICATIONS WHICH REQUIRE A GREAT DEGREE OF PRECISION, WE RECOMMEND THAT THE PRODUCT ITSELF BE USED TO MAKE THE ACTUAL MEASUREMENTS. SONY WILL NOT BE HELD RESPONSIBLE FOR INACCURACIES IN THE DESIGN OR MANUFACTURE OF ENCLOSURES.

Consumer Integrated Systems - Park Ridge, New Jersey 07656 - Fax (201)930-7891 - www.sony.com/dn

Features and specifications subject to change without notice. Non-Metric weights and measurements are approximate.

SONY

Model: KDL-60EX500

Description: LCD TV

Dimensions: 57 $\frac{3}{8}$ " 35 $\frac{7}{8}$ " 15 $\frac{1}{4}$ "

(WHD): 57 $\frac{3}{8}$ " 34 $\frac{3}{8}$ " 4 $\frac{3}{4}$ " w/o stand

Weight: 95.2 lb

Carton Dimensions: tbd
(WHD):

Power 120V AC
requirements: 60HZ

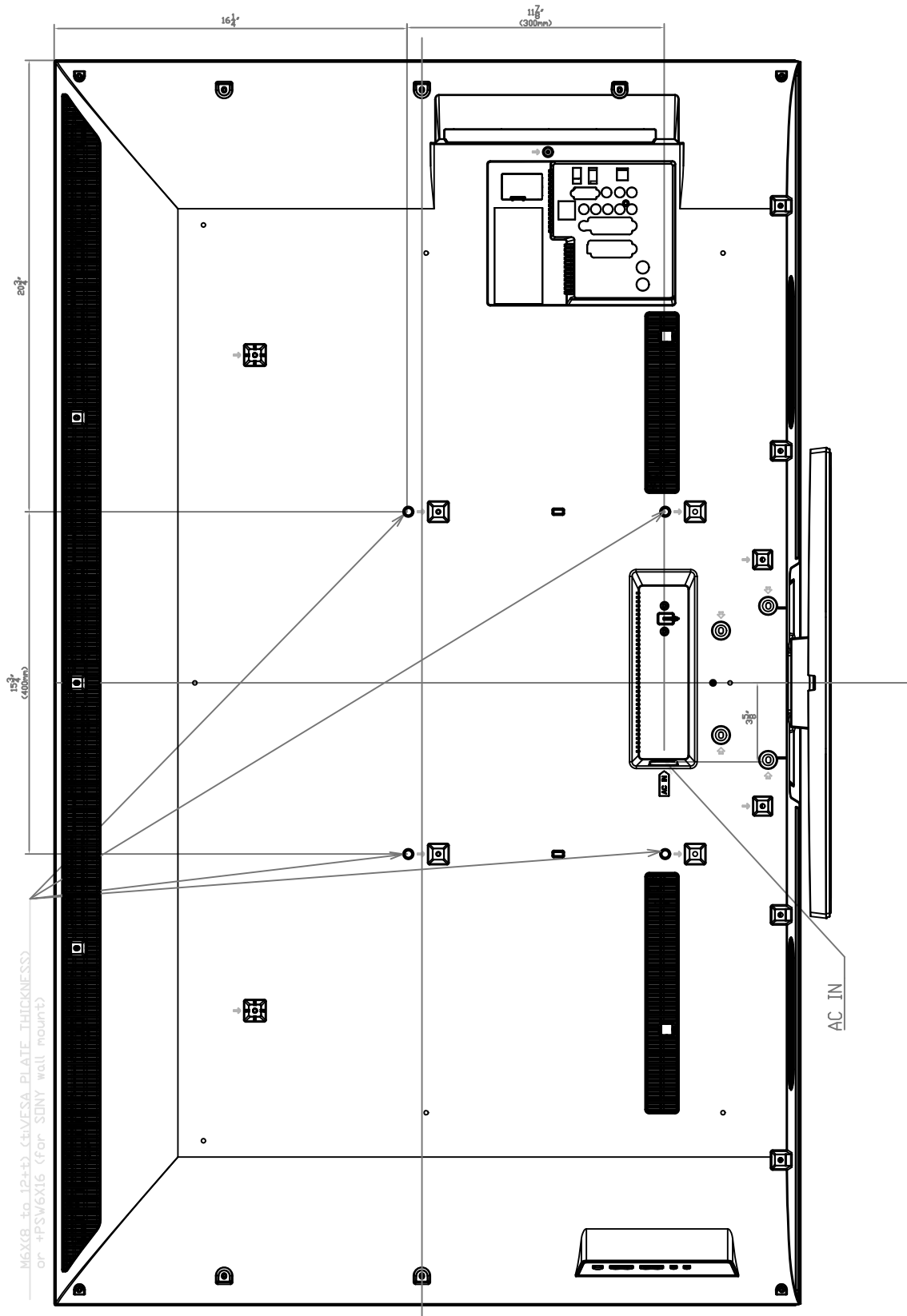

NOTE:

WHERE THERE ARE CLOSE TOLERANCES INVOLVED IN CABINET BUILDING OR APPLICATIONS WHICH REQUIRE A GREAT DEGREE OF PRECISION, WE RECOMMEND THAT THE PRODUCT ITSELF BE USED TO MAKE THE ACTUAL MEASUREMENTS. SONY WILL NOT BE HELD RESPONSIBLE FOR INACCURACIES IN THE DESIGN OR MANUFACTURE OF ENCLOSURES.

Consumer Integrated Systems - Park Ridge, New Jersey 07656 - Fax (201)930-7891 - www.sony.com/dh

SONY

Model: KDL-60EX500

Description: LCD TV

Dimensions: 57³/₈" 35⁷/₈" 15¹/₄"

(WHD): 57³/₈" 34³/₈" 4³/₄" w/o stand

Weight: 95.2 lb

Carton Dimensions: tbd (WHD):

Power requirements: 120V AC 60HZ

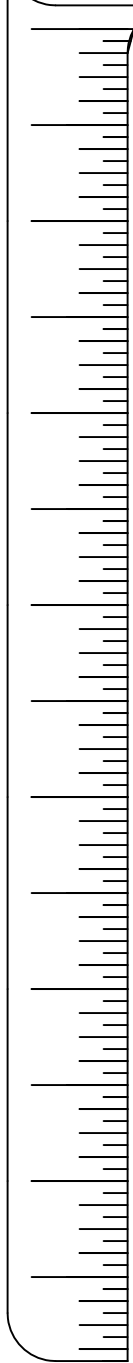

PANEL C.L.

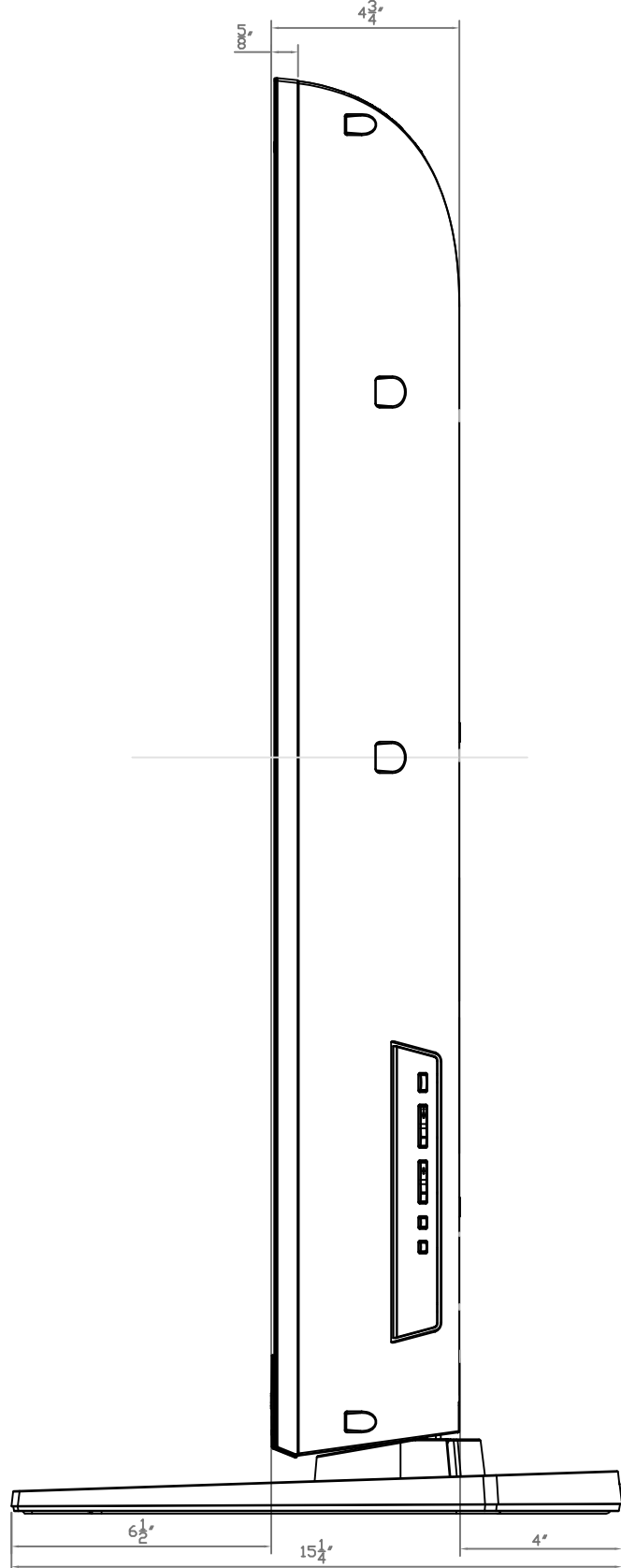
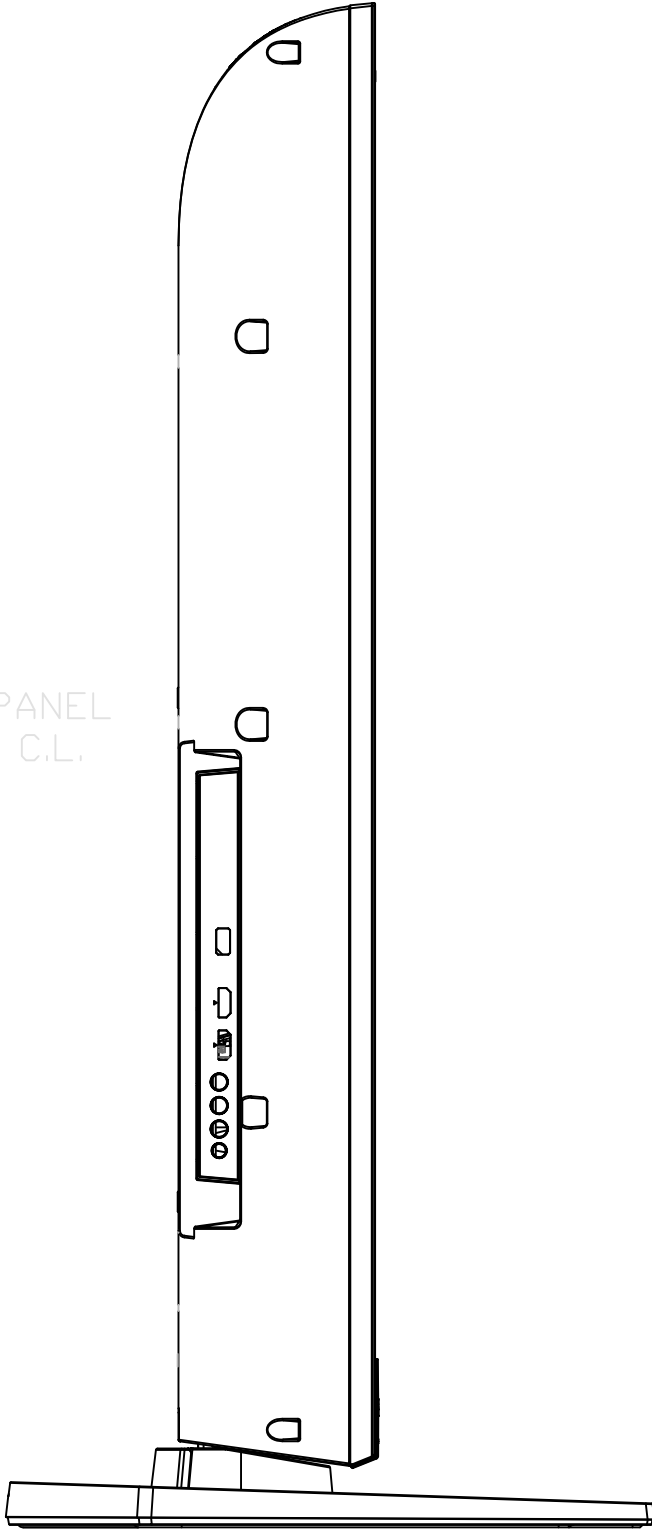

NOTE:

WHERE THERE ARE CLOSE TOLERANCES INVOLVED IN CABINET BUILDING OR APPLICATIONS WHICH REQUIRE A GREAT DEGREE OF PRECISION, WE RECOMMEND THAT THE PRODUCT ITSELF BE USED TO MAKE THE ACTUAL MEASUREMENTS. SONY WILL NOT BE HELD RESPONSIBLE FOR INACCURACIES IN THE DESIGN OR MANUFACTURE OF ENCLOSURES.

Consumer Integrated Systems - Park Ridge, New Jersey 07656 - Fax (201)930-7891 - www.sony.com/dn

Features and specifications subject to change without notice. Non-Metric weights and measurements are approximate.

SONY

Model: KDL-60EX500

Description: LCD TV

Dimensions: 57 $\frac{3}{8}$ " 35 $\frac{7}{8}$ " 15 $\frac{1}{4}$ "

(WHD): 57 $\frac{3}{8}$ " 34 $\frac{3}{8}$ " 4 $\frac{3}{4}$ " w/o stand

Weight: 95.2 lb

Carton Dimensions: tbd
(WHD):

Power 120V AC
requirements: 60HZ

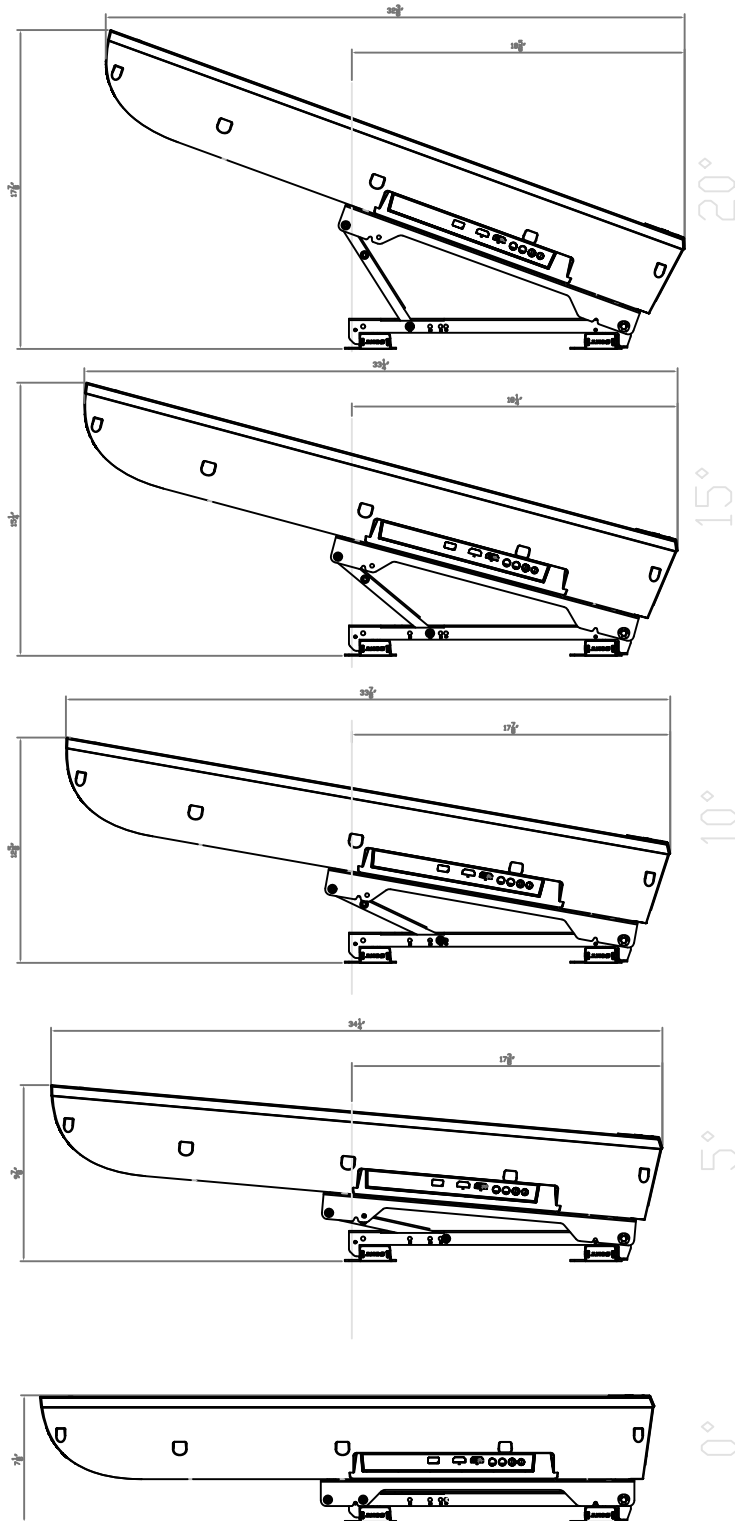

NOTE:

WHERE THERE ARE CLOSE TOLERANCES INVOLVED IN CABINET BUILDING OR APPLICATIONS WHICH REQUIRE A GREAT DEGREE OF PRECISION, WE RECOMMEND THAT THE PRODUCT ITSELF BE USED TO MAKE THE ACTUAL MEASUREMENTS. SONY WILL NOT BE HELD RESPONSIBLE FOR INACCURACIES IN THE DESIGN OR MANUFACTURE OF ENCLOSURES.

Consumer Integrated Systems - Park Ridge, New Jersey 07656 - Fax (201)930-7891 - www.sony.com/dn

Features and specifications subject to change without notice. Non-Metric weights and measurements are approximate.

SONY

Model: KDL-60EX500

Description: LCD TV

Dimensions: 57 $\frac{3}{8}$ " 35 $\frac{7}{8}$ " 15 $\frac{1}{4}$ "

(WHD): 57 $\frac{3}{8}$ " 34 $\frac{3}{8}$ " 4 $\frac{3}{4}$ " w/o stand

Weight: 95.2 lb

Carton Dimensions: tbd
(WHD):

Power 120V AC
requirements: 60HZ

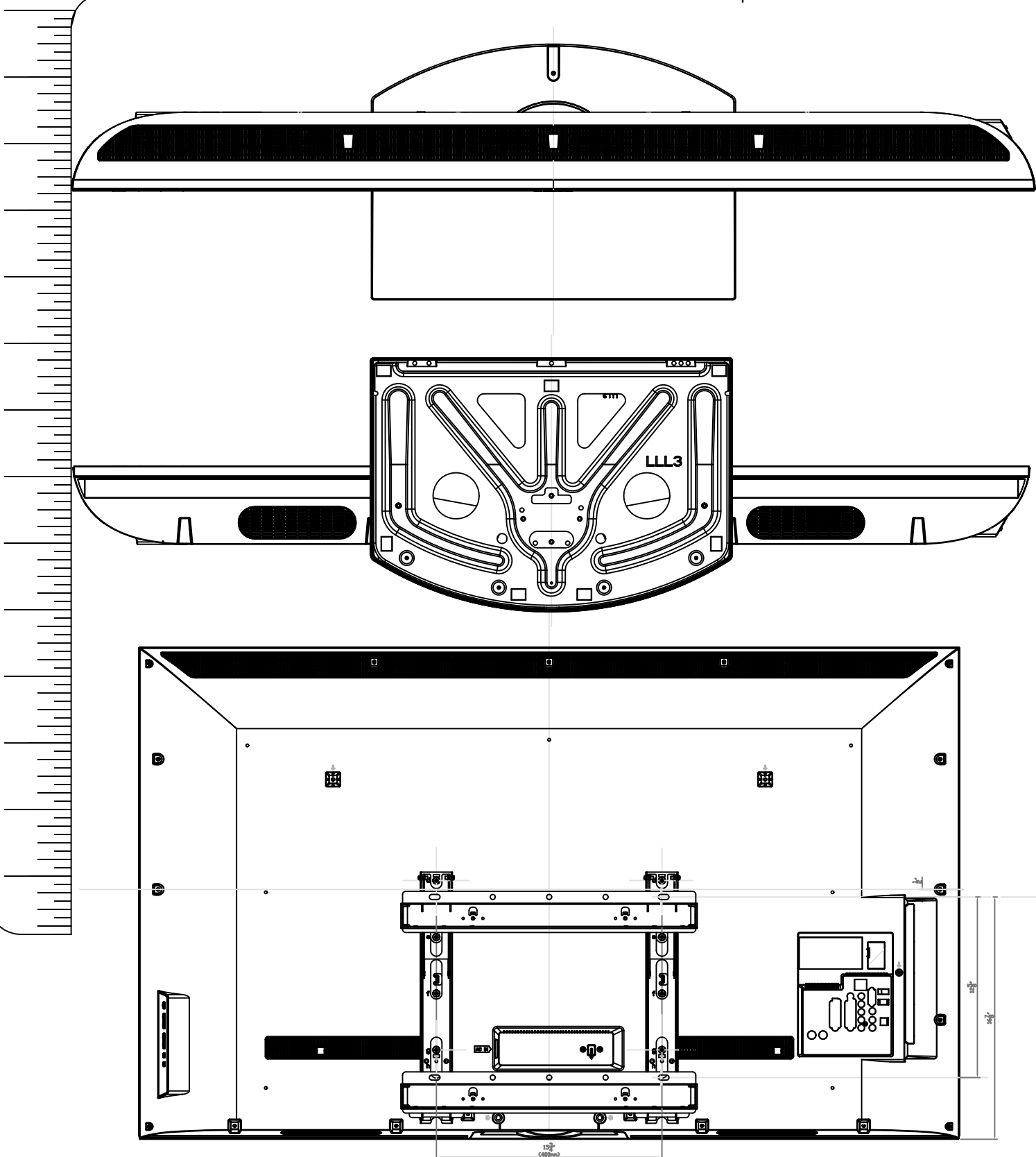

NOTE:

WHERE THERE ARE CLOSE TOLERANCES INVOLVED IN CABINET BUILDING OR APPLICATIONS WHICH REQUIRE A GREAT DEGREE OF PRECISION, WE RECOMMEND THAT THE PRODUCT ITSELF BE USED TO MAKE THE ACTUAL MEASUREMENTS. SONY WILL NOT BE HELD RESPONSIBLE FOR INACCURACIES IN THE DESIGN OR MANUFACTURE OF ENCLOSURES.

Consumer Integrated Systems - Park Ridge, New Jersey 07656 - Fax (201)930-7891 - www.sony.com/dn

Features and specifications subject to change without notice. Non-Metric weights and measurements are approximate.