

SERVICE MANUAL

US Model

Chassis No. SCC-B550-A

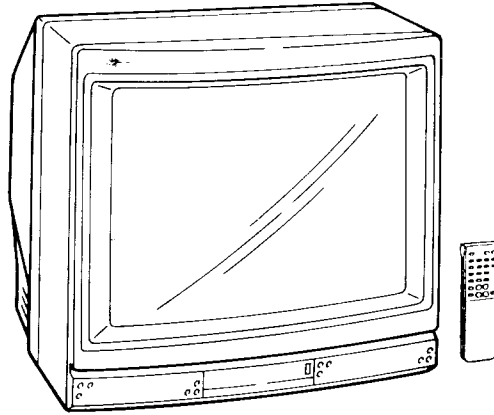

P-3A CHASSIS

Note: The service manual for RM-757 has been issued separately.

MODELS OF THE SAME SERIES

KV-27TS25	

SPECIFICATIONS

Television system	American TV standards	Accessories supplied	Remote Commander RM-757 with 2 size AA batteries
Channel coverage	VHF: 2-13 UHF: 14-69 Cable TV: 1-125	Optional accessories	Antenna connector U/V mixer EAC-66 Connecting cord VMC-810S/820S RK-C74/150
Picture tube	Microblack Trinitron tube 27-inch picture measured diagonally 28-inch picture tube measured diagonally	Design and specifications subject to change without notice.	
Input	VIDEO INPUT (phono jacks) Video: 1 Vp-p, 75-ohms unbalanced, sync negative Audio: 500 mVrms (100% modulation) Impedance: 47 kilohms		
Output	AUDIO OUTPUT (VARIABLE) (phono jacks) More than 408 mVrms at the maximum volume setting (variable) (100% modulation) Impedance: 10 kilohms		
Power requirements	120 V AC, 60 Hz		
Power consumption	160W (max.) 5W (in standby condition)		



TRINITRON® COLOR TV
SONY®

TABLE OF CONTENTS

<u>Section</u>	<u>Title</u>	<u>Page</u>	<u>Section</u>	<u>Title</u>	<u>Page</u>
1. GENERAL			5. CIRCUIT ADJUSTMENTS		
1-1.	Location of Controls	4	5-1.	A Board Adjustments	17
1-2.	Timer/Block	4	6. DIAGRAMS		
1-3.	Presetting TV Channels	6	6-1.	Block Diagram	19
1-4.	Watching TV Programs	7	6-2.	Circuit Boards Location	24
2. DISASSEMBLY			6-3.	Schematic Diagram	25
2-1.	Rear Cover Removal	8	6-4.	Printed Wiring Boards	29
2-2.	A Board Removal	8	6-5.	Semiconductors	36
2-3.	Service Position	9	7. EXPLODED VIEWS		
2-4.	Picture Tube Removal	10	7-1.	Rear Cover	37
2-5.	Removal of Anode Cap	10	7-2.	Picture Tube	38
3. SET-UP ADJUSTMENTS			8. ELECTRICAL PARTS LIST		39
3-1.	Beam Landing	11			
3-2.	Convergence	12			
3-3.	Focus Adjustment	14			
3-4.	White Balance	14			
4. SAFETY RELATED ADJUSTMENT		15			

WARNING !!

AN ISOLATION TRANSFORMER SHOULD BE USED DURING ANY SERVICE TO AVOID POSSIBLE SHOCK HAZARD, BECAUSE OF LIVE CHASSIS. THE CHASSIS OF THIS RECEIVER IS DIRECTLY CONNECTED TO THE AC POWER LINE.

SAFETY-RELATED COMPONENT WARNING !!

COMPONENTS IDENTIFIED BY SHADING AND MARK  ON THE SCHEMATIC DIAGRAMS, EXPLODED VIEWS AND IN THE PARTS LIST ARE CRITICAL TO SAFE OPERATION. REPLACE THESE COMPONENTS WITH SONY PARTS WHOSE PART NUMBERS APPEAR AS SHOWN IN THIS MANUAL OR IN SUPPLEMENTS PUBLISHED BY SONY. CIRCUIT ADJUSTMENTS THAT ARE CRITICAL TO SAFE OPERATION ARE IDENTIFIED IN THIS MANUAL. FOLLOW THESE PROCEDURES WHENEVER CRITICAL COMPONENTS ARE REPLACED OR IMPROPER OPERATION IS SUSPECTED.

SAFETY CHECK-OUT

After correcting the original service problem, perform the following safety checks before releasing the set to the customer:

1. Check the area of your repair for unsoldered or poorly-soldered connections. Check the entire board surface for solder splashes and bridges.
2. Check the interboard wiring to ensure that no wires are "pinched" or contact high-wattage resistors.
3. Check that all control knobs, shields, covers, ground straps, and mounting hardware have been replaced. Be absolutely certain that you have replaced all the insulators.
4. Look for unauthorized replacement parts, particularly transistors, that were installed during a previous repair. Point them out to the customer and recommend their replacement.
5. Look for parts which, though functioning, show obvious signs of deterioration. Point them out to the customer and recommend their replacement.
6. Check the line cord for cracks and abrasion. Recommend the replacement of any such line cord to the customer.
7. Check the condition of the monopole antenna (if any).
Make sure the end is not broken off, and has the plastic cap on it. Point out the danger of impalement on a broken antenna to the customer, and recommend the antenna's replacement.
8. Check the B+ and HV to see they are at the values specified. Make sure your instruments are accurate; be suspicious of your HV meter if sets always have low HV.
9. Check the antenna terminals, metal trim, "metallized" knobs, screws, and all other exposed metal parts for AC leakage. Check leakage as described below.

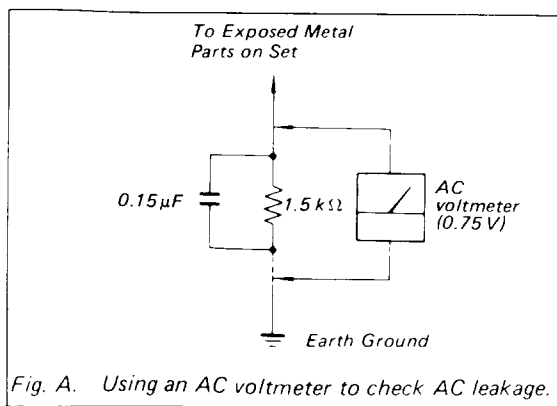

Fig. A. Using an AC voltmeter to check AC leakage.

LEAKAGE TEST

The AC leakage from any exposed metal part to earth ground and from all exposed metal parts to any exposed metal part having a return to chassis, must not exceed 0.5 mA (500 microamperes). Leakage current can be measured by any one of three methods.

1. A commercial leakage tester, such as the Simpson 229 or RCA WT-540A. Follow the manufacturers' instructions to use these instruments.
2. A battery-operated AC milliammeter. The Data Precision 245 digital multimeter is suitable for this job.
3. Measuring the voltage drop across a resistor by means of a VOM or battery-operated AC voltmeter. The "limit" indication is 0.75 V, so analog meters must have an accurate low-voltage scale. The Simpson 250 and Sanwa SH-63Trd are examples of a passive VOM that is suitable. Nearly all battery operated digital multimeters that have a 2V AC range are suitable. (See Fig. A)

HOW TO FIND A GOOD EARTH GROUND

A cold-water pipe is guaranteed earth ground; the cover-plate retaining screw on most AC outlet boxes is also at earth ground. If the retaining screw is to be used as your earth-ground, verify that it is at ground by measuring the resistance between it and a cold-water pipe with an ohmmeter. The reading should be zero ohms. If a cold-water pipe is not accessible, connect a 60-100 watts trouble light (not a neon lamp) between the hot side of the receptacle and the retaining screw. Try both slots, if necessary, to locate the hot side of the line, the lamp should light at normal brilliance if the screw is at ground potential. (See Fig. B)

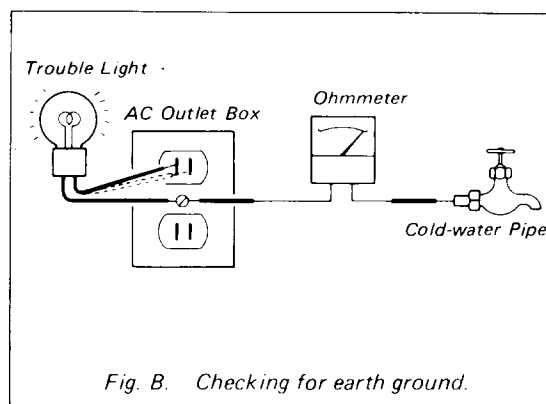
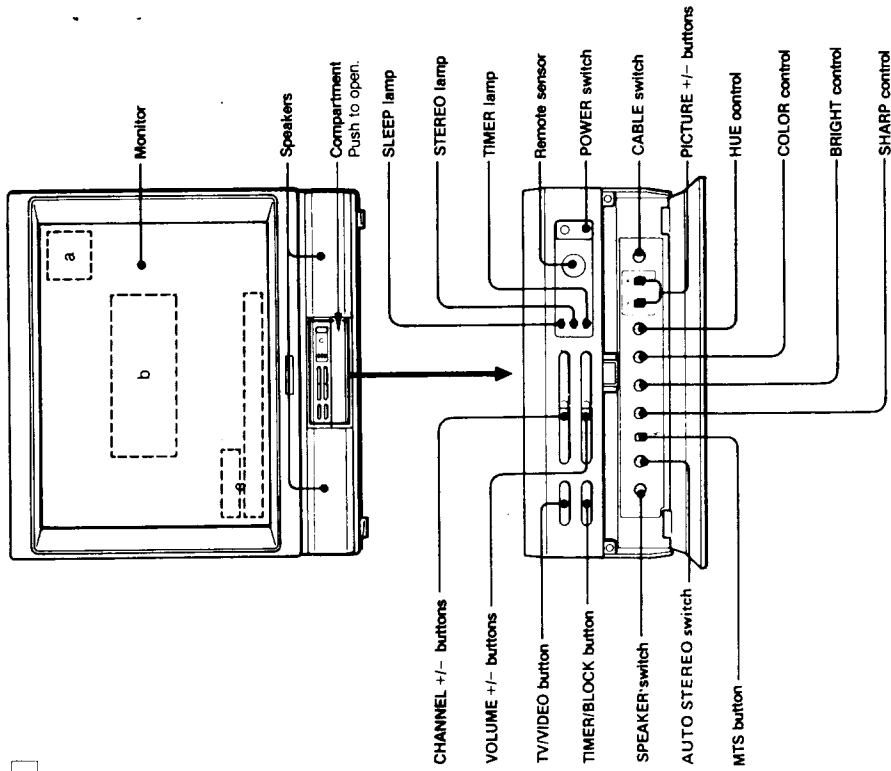

Fig. B. Checking for earth ground.

SECTION 1 GENERAL

1-1. LOCATION OF CONTROLS



- On-screen displays**
- a) Channel numbers
 - MTS mode indication
 - "MUTING", "SLEEP" or "VIDEO" mode indication
 - b) "AUTO PROGRAM", "TIMER" or "TIMER BLOCK" indication
 - c) Bar display for volume or picture adjustment
 - Current time for Timer/Block

1-2. TIMER/BLOCK

Available functions

Internal clock	Once the internal clock is set, the current time will appear on the screen. It is necessary to set the clock correctly to activate the program start TIMER and channel BLOCK.
Program start TIMER	Makes a program of your choice appear on the screen automatically at the desired time.
Channel BLOCK	Blocks a channel from appearing on the screen for 12 hours. Use channel BLOCK to prevent children from watching undesirable programs.

The buttons used for the above functions are located on the Remote Commander.

To set the internal clock, program start TIMER and channel BLOCK, you must summon the corresponding "pages": "clock page", "TIMER page" and "BLOCK page."

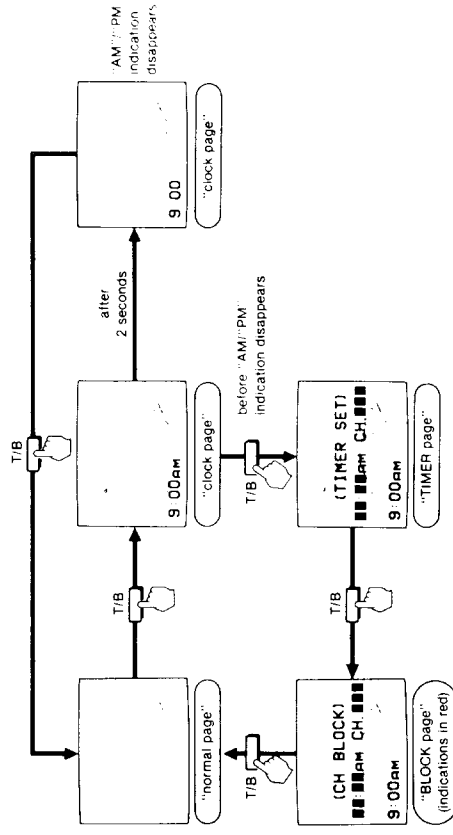

- All settings will be erased from the unit's memory if the unit is unplugged, or if a power failure occurs.
- The TIMER and BLOCK will operate only if the clock is set correctly.
- If the TIMER and BLOCK are set for overlapping times on the same channel, the blocked channel will appear on the screen at the time set on the TIMER.

How to Set the Internal Clock

Example: To set the clock to 8:05 PM

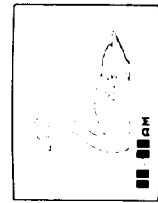

"clock page"

1 Press TIMER/BLOCK once to change from "normal page" to "clock page."

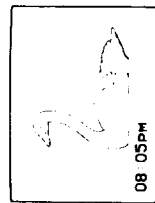

08 05PM

2 Press 0, 8, 0, 5, AM/PM (0 necessary).

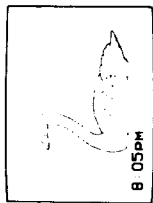

8 05PM

3 If you have performed the operation correctly, press ENTER. The numbers will "wink" to indicate that the clock has been set. (The 0 in front will disappear)

If you have made a mistake, press CLEAR and return to step 2.

The "AM/PM" indication will disappear after 2 seconds.

To summon "TIMER page," press TIMER/BLOCK before the "AM"/"PM" indication disappears.
To return to "normal page," press TIMER/BLOCK after the "AM"/"PM" indication has disappeared.

How to Set the Channel BLOCK

Make sure that the clock has been set correctly before setting the channel BLOCK.

Example: To set the BLOCK for a program which begins at 9:30 AM on channel 8

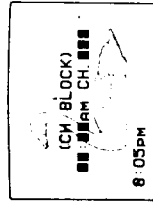

"BLOCK page"
(indications in red)

1 Press TIMER/BLOCK three times to change from "normal page" to "BLOCK page."

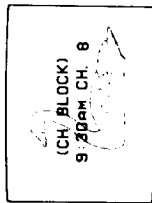

9:30AM CH. 8

2 Press 0, 9, 3, 0, ENTER (0 necessary). Numbers will "wink" to indicate that the time has been set.

Press 8, ENTER (0 not necessary). Numbers will "wink" to indicate that the channel has been set.

The BLOCK has now been set. If you have made a mistake, press CLEAR and return to step 2.

At the preset time, the picture of the selected channel will be blocked from view and the sound will be muted. A red "BLOCKED" indication will appear on the screen while the channel is blocked. Normal reception will be resumed after 12 hours.

To return to normal reception while the channel is blocked, recall "BLOCK page" and press CLEAR.

The BLOCK setting blocks a specified channel for the same 12-hour period everyday.

To clear BLOCK setting, summon "BLOCK page" and press CLEAR.

To reset, clear the setting and follow the steps above from step 2.

12:00 AM stands for midnight.
12:00 PM stands for noon.

How to Set the Program Start TIMER

Make sure that the clock has been set correctly before setting the program start TIMER.

Example: To set the TIMER for a program which begins at 10:30 PM on channel 12

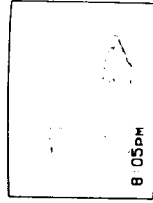

"clock page"

1 Press TIMER/BLOCK once to change from "normal page" to "clock page."

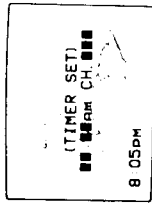

8 05PM

2 Press TIMER/BLOCK before the "AM"/"PM" indication disappears and summon "TIMER page."

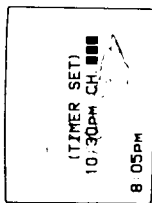

8 05PM

3 Press 1, 0, 3, 0, AM/PM, ENTER. Numbers will "wink" to indicate that the time has been set.

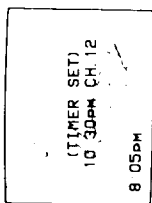

8 05PM

4 Press 1, 2, ENTER (0 not necessary). Numbers will "wink" to indicate that the channel has been set.

The TIMER lamp will light up to indicate that the TIMER has been set. If you have made a mistake, press CLEAR and return to step 3.

At the preset time, the selected channel will appear on the screen and the TIMER lamp will go out. The TIMER will operate whether you are watching a TV program or a VCP playback, or even if you have turned off the TV.

If no button is pressed within 2 hours after the preset time, an "OFF" indication will appear on the screen for 1 minute. If a button is still not touched during the 1 minute, the TV will turn off automatically as a safety precaution.

If you want to deactivate the TIMER, press TIMER OFF/REPEAT again so that the TIMER lamp goes out. It is not necessary to summon "TIMER page" to use the TIMER OFF/REPEAT button. Furthermore, this button is effective even if the TV has been turned off.

To clear the TIMER setting, summon "TIMER page" and press CLEAR.
To reset, clear the setting and follow the steps from step 3.

1-3. PRESETTING TV CHANNELS

Use the Remote Commander.

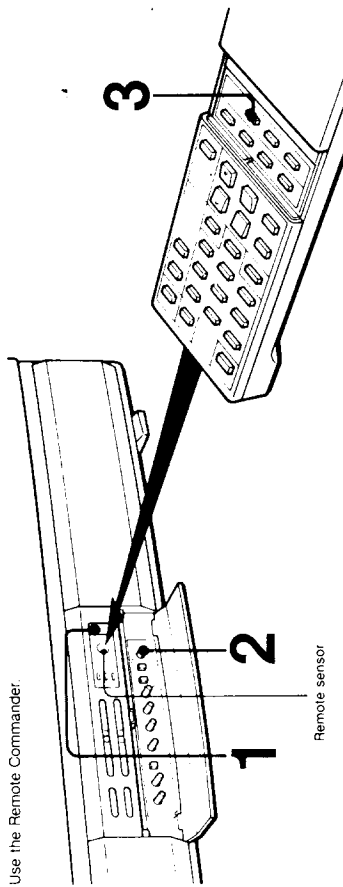

Remote sensor

1 Turn the TV on.

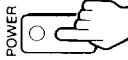

2 Set CABLE to the correct position.



3 Press AUTO PROG.



"AUTO PROGRAM" is displayed on the screen and receivable channels (other than the channels already preset) will be preset in numerical sequence. The channels previously preset remain in the unit's memory.

When no more channels can be found, the programming stops and the lowest numbered channel is displayed.



Receivable channels of this TV are:

VHF: 2, 13
UHF: 14-69
Cable: 1-125

To check preset channels
Press CHANNEL +/-.

To add the channels that could not be preset with this automatic programming because their signal strength was too weak, or to erase unnecessary channels, follow the steps in "To preset only the desired channels."

To preset only the desired channels
— manual programming

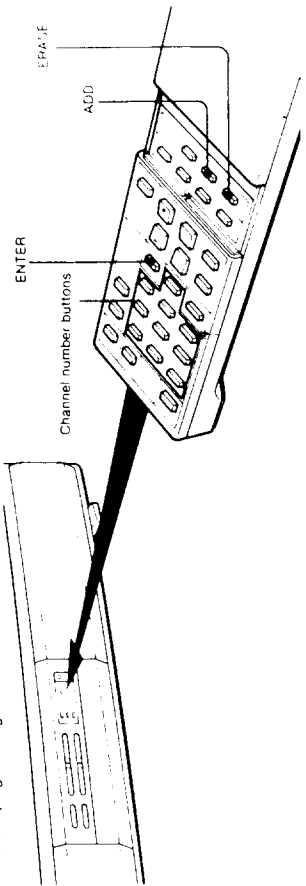

1 Press the channel number button(s) and then ENTER to select the channel to be added.

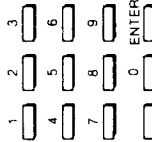

A "+" appears for a moment to the left of the on-screen channel number display. This channel has now been added to the channel scan memory.

2 Press ADD.



To add other channels
Repeat steps 1 to 2.



To erase unnecessary channels
1 Select the channel to be erased.
2 Press ERASE.

A "-" appears for a moment to the left of the on-screen channel number display. This channel has now been erased from the channel scan memory.

Repeat steps 1 and 2 for other channels to be erased.

To add the channels that could not be preset with this automatic programming because their signal strength was too weak, or to erase unnecessary channels, follow the steps in "To preset only the desired channels" on the next page.

Pay cable TV systems use scrambled or encoded signals, and require special converters (decoders) in addition to the normal cable connection.

Cable TV channel chart*
Cable TV systems use letters or numbers to designate channels. To tune in a channel, refer to the chart below.

Number on this TV	1	5	6	14	15	16	17	18	19	20	21	22	23	24	25	26	27	28	29	30
Corresponding CATV channel	A-8	A-7	A-6	A	B	C	D	E	F	G	H	I	J	K	L	M	N	O	P	Q
31	32	33	34	35	36	37	38	39	40	41	42	43	44	45	46	47	48	49	50	101
R	S	T	U	V	W	W+1	W+2	W+3	W+4	W+5	W+6	W+7	W+8	W+9	W+10	W+11	W+12	W+13	W+14	123
																				124
																				125

Check with your local cable TV company for more complete information on the available channels.

* The designation of the cable TV channels conforms to the EIA/INCA recommendation.

1-4. WATCHING TV PROGRAMS

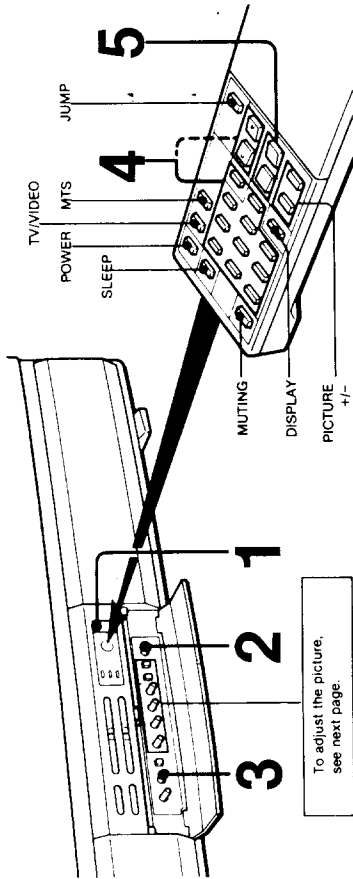

To adjust the picture, see next page.

1 Press **POWER** to turn the TV on.

2 Set **CABLE** to the appropriate position.

3 Set **AUTO STEREO** to ON.

When receiving a Multichannel TV Sound program
Each time MTS is pressed, MAIN, SAP (Second Audio Program), or both are selected in sequence. The corresponding indication will appear on the screen for a while.

If noise makes it hard to receive a very weak TV stereo program
Set AUTO STEREO on the TV to OFF so that the STEREO lamp goes off.
The stereo effect will be cancelled, but reception will be stabilized and the noise will be reduced.

To mute the sound
Press MUTING. The "MUTING" indication will appear on the screen. To restore the sound, press MUTING again or VOL +/-.

To keep the channel display on the screen
Press DISPLAY.

To adjust the picture

SHARP 	BRIGHT 	COLOR 	HUE 	PICTURE
for more sharpness	for less brightness	for less color intensity	skin tones become purplish	Press to increase picture contrast with soft color
for more sharpness	for more brightness	for more color intensity	skin tones become greenish	Press to increase picture contrast with soft color

4 Select a channel in one of the following two ways:

To scan the preset channels in numerical sequence, press CH +/-.

To select a channel directly, press the channel number button(s) and then ENTER. For example, to select channel 10, press 1, 0 and ENTER.

5 Press VOL + or - to adjust the volume.

To cancel the SLEEP timer, press SLEEP again so that the SLEEP lamp goes out, or turn off the TV.

To turn off the system
Press POWER again.

To switch quickly between 2 channels
Press JUMP. Each time JUMP is pressed, the channel which appeared on the screen directly before is recalled. This button enables you to keep track of two programs alternately.

To have the TV turn off automatically after about 1 hour
Press SLEEP. The "SLEEP" indication will appear on the screen for a few seconds and the SLEEP lamp on the TV will remain lit until the TV is turned off.