



MDR-1RBT

[Getting Started](#) >

[BLUETOOTH](#) >

[One touch connection \(NFC\)](#) >

[Music](#) >

[Phone calls](#) >

[Troubleshooting](#) >

[Important information](#) >



Getting Started

[Before First Use](#) >

[Features and location of parts](#) >

[Power](#) >



BLUETOOTH

[BLUETOOTH](#) >

[BLUETOOTH connection](#) >



One touch connection (NFC)

[One touch connection \(NFC\)](#) >

[One touch connection](#) >



Music

[Listening to music](#)



[Using the unit by connecting the supplied cord](#)





Phone calls

[Phone calls](#)



[Making a call while playing back music](#)





Troubleshooting

[To deal with a trouble](#)



[Possible causes of symptoms](#)





Important information

[Important information](#)



Copyright 2012 Sony Corporation



Before First Use

[Before first use](#)



Copyright 2012 Sony Corporation



Features and location of parts

[Features](#) >

[Location and function of parts](#) >

Copyright 2012 Sony Corporation



Power

[Charging the headset](#)





BLUETOOTH

[What is BLUETOOTH wireless technology?](#)



[What you can do with BLUETOOTH function](#)



Copyright 2012 Sony Corporation



BLUETOOTH connection

[Steps to BLUETOOTH function](#) >

[Pairing and connecting with a BLUETOOTH device](#) >

[Connecting with the paired device](#) >

[Indications of BLUETOOTH function](#) >



One touch connection (NFC)

[Compatible smartphones](#)



[Preparation on the smartphone](#)



[About “NFC Easy Connect” App](#)





One touch connection

[Connecting with the smartphone by one touch](#) >

[Disconnecting the smartphone by one touch](#) >

[Switching the device by one touch](#) >



Listening to music

[Listening to music](#) >

[Controlling the audio device](#) >

Copyright 2012 Sony Corporation



Using the unit by connecting the supplied cord

[Using the headset by connecting the supplied cord](#) >

Copyright 2012 Sony Corporation



Phone calls

[Making a call](#) >

[Receiving a call](#) >

[Controlling the smartphone or mobile phone](#) >



Making a call while playing back music

[Making a call while playing back music \(Multi point connection\)](#) >

Copyright 2012 Sony Corporation



To deal with a trouble

[What can I do to solve a problem?](#)





Possible causes of symptoms

[Table of contents for symptoms and possible causes](#) >

[Power and charging](#) >

[BLUETOOTH connection](#) >

[One touch connection \(NFC\)](#) >

[Music](#) >

[Phone calls](#) >



Important information

[License and trademark notice](#)



Copyright 2012 Sony Corporation



Before first use

In addition to this Help Guide, read the printed manuals supplied: “Quick Start Guide” and “Reference Guide.”

Quick Start Guide

This covers initial settings and basic operations.

Reference Guide

This includes information about using your wireless stereo headset safely, and specifications of your wireless stereo headset.

For information about the customer support Web site, access:

<http://www.sony.net/>

About battery charging

See “Charging the headset” on how to charge the battery. [\[Details\]](#)



Features

- One touch connection (NFC)
- S-Master
- DSEE

Offers natural sound with a spacious feel by restoring high frequency sound and the tail shape of the waveform likely to be removed through the audio compression process.

- BLUETOOTH Ver.3.0
- Liquid crystal polymer film diaphragm, HD driver Unit
- Enfolding Structure

Pressure-relieving cushions, tailored for the ears, provide a wrap-around feel with acoustic sealing to deliver powerful lows.

- Silent joints
- Inward axis structure
- Carrying pouch
- Charge via USB with attached micro-USB cable



Location and function of parts

Functions of buttons, jacks, and other parts on your wireless stereo headset are explained here.

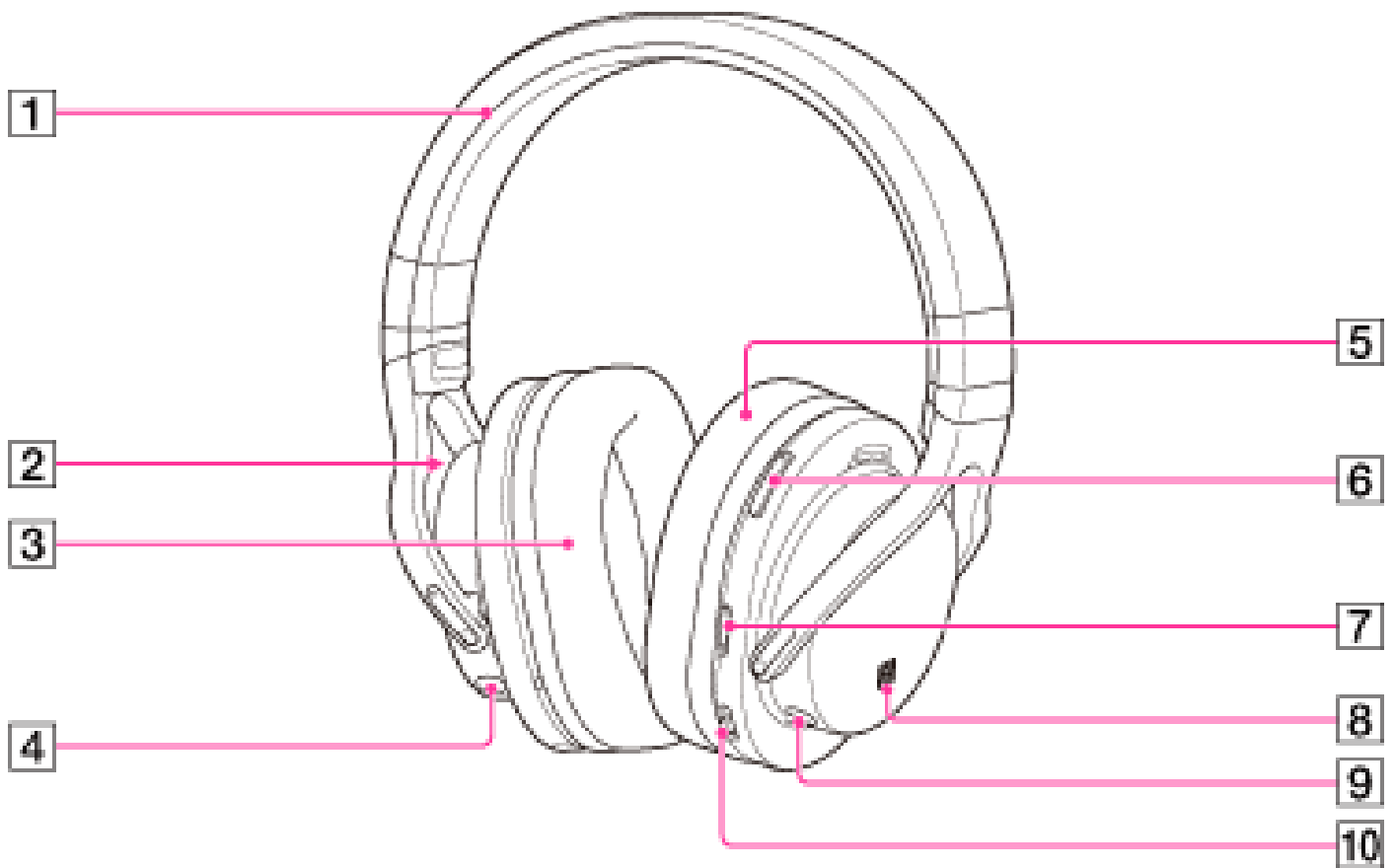

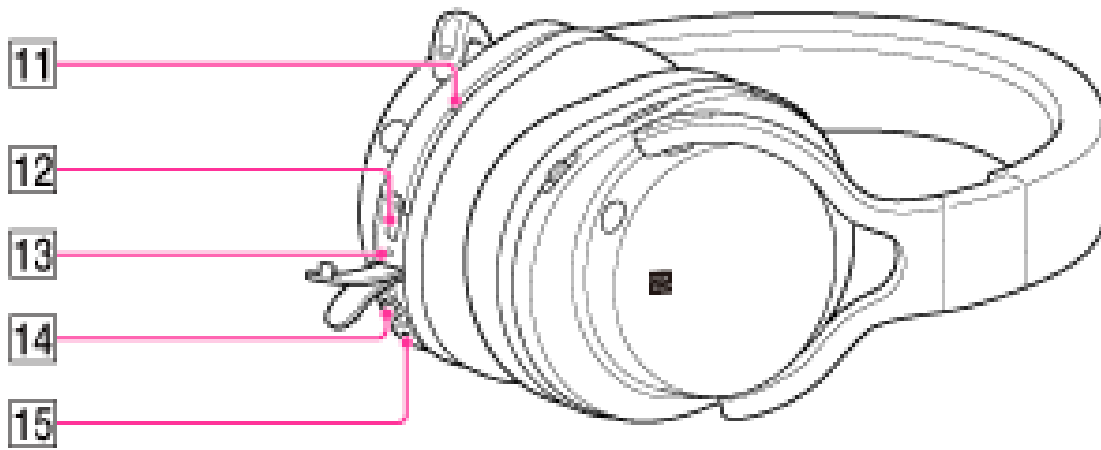

1 Headband

2 Built-in antenna

The BLUETOOTH antenna is built into the headset.

3 Left (L) unit

4 POWER button

5 Right (R) unit

6 VOL (volume) +/- buttons

The + button has a tactile dot.

7 NFC ON/OFF switch [\[Details\]](#)

This switch enables or disables the one touch connection function.

8 N mark [\[Details\]](#)

9  button

Controls various call functions.

10 Jog switch

Controls various functions when listening to music.

11 Indicator

Lights up in red or blue to indicate the power or communication status of the headset.

12 Micro-USB port [\[Details\]](#)

Connect a computer to this port with the supplied micro-USB cable to charge the headset.

13 RESET button [\[Details\]](#)

Press the button with a pointing object, such as a pin, to reset the headset.

14 INPUT jack [\[Details\]](#)

Connect a music player, etc. to this jack by using the supplied cord. Make sure that you insert the plug of the music player until it clicks. Otherwise, you may not hear the sound normally.

15 Microphone

Copyright 2012 Sony Corporation



Charging the headset

The headset contains a lithium ion rechargeable battery, which should be charged before using the headset for the first time.

System requirements for battery charge using USB

Personal Computer with pre-installed with any of the following operating systems and USB port:

Operating Systems

(when using Windows)

Windows® 7

Home Basic / Home Premium / Professional / Ultimate

Windows Vista® (Service Pack 2 or later)

Home Basic / Home Premium / Business / Ultimate

Windows® XP (Service Pack 3 or later)

Home Edition / Professional / Media Center Edition 2004 / Media Center Edition 2005

(when using Macintosh)

Mac OS X (version.10.3 or later)

Charging the headset

1. Open the cover of the micro-USB port.

Insert the tip of your fingernail in the groove, and open the cover.

Ⓛ

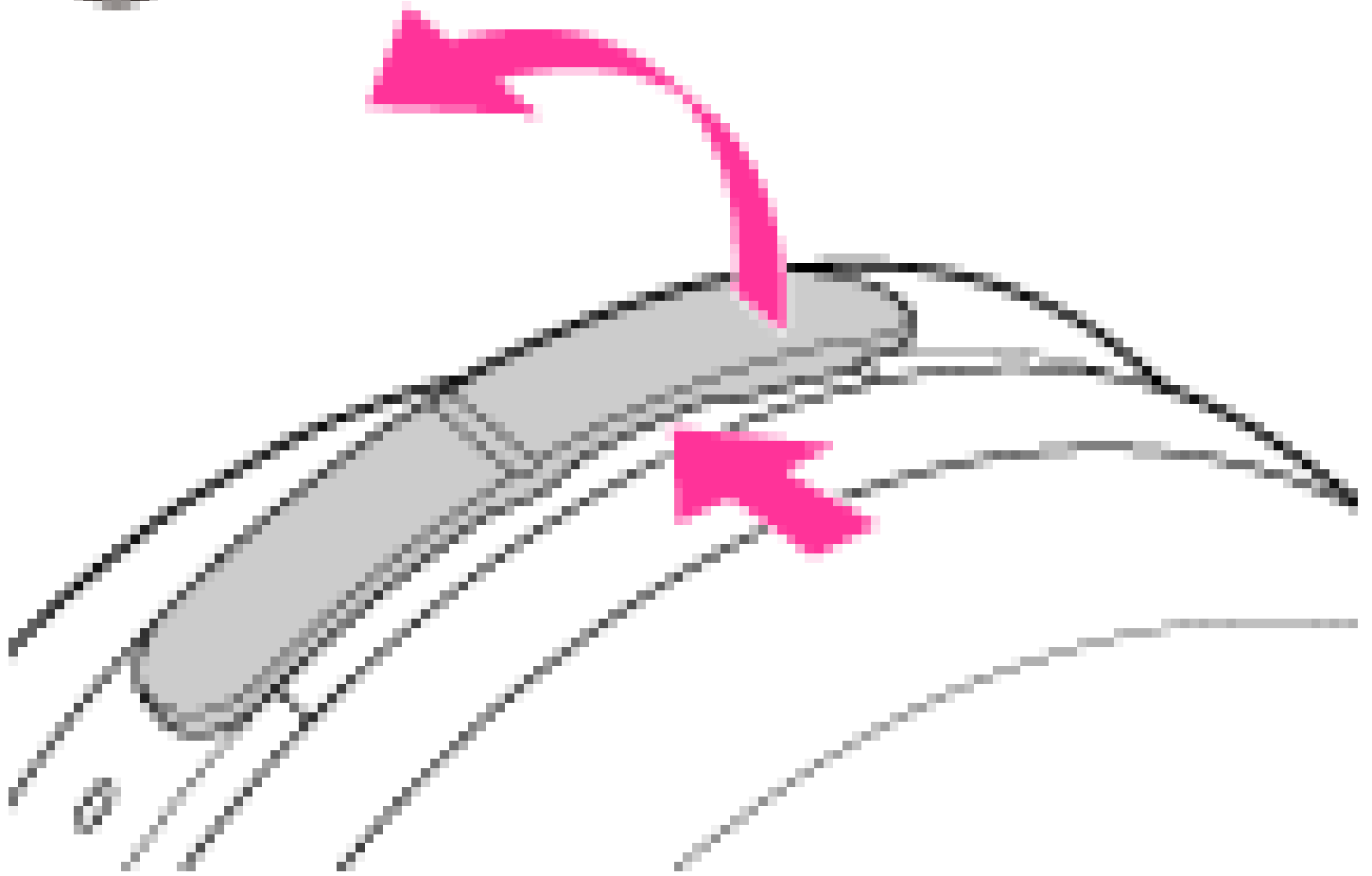

2. Connect the supplied micro-USB cable to the headset, and then connect the other end to a computer.
Make sure that you connect the plug of the micro-USB cable in the direction as shown in the illustration below.

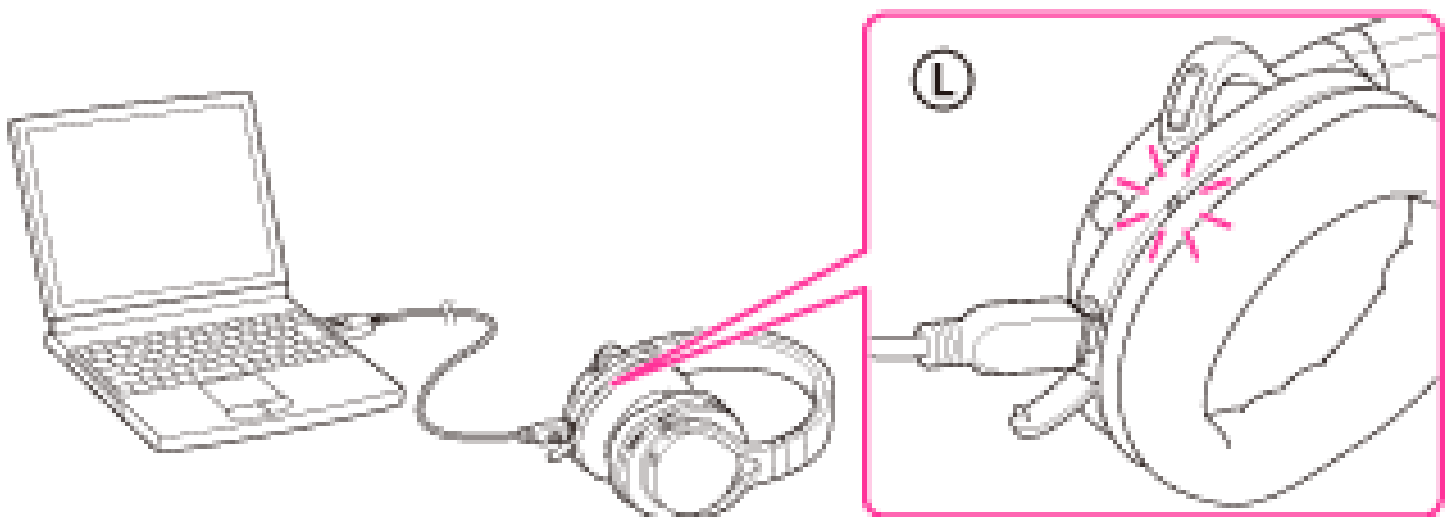

Charging starts when the headset and the computer are connected. Make sure that the indicator (red) lights up. Charging is completed in about 6 hours* and the indicator (red) goes off automatically.

* Time required to charge the empty battery to its full capacity

Notes

- If the headset is not used for a long time, the indicator (red) may not light up when you connect the micro-USB cable to charge the headset. In this case, do not disconnect the micro-USB cable from the headset and wait until the indicator (red) lights up.
- When you close the cover of the micro-USB port after charging the battery, push the catch at the edge (the round part) of the cover into the port compartment.

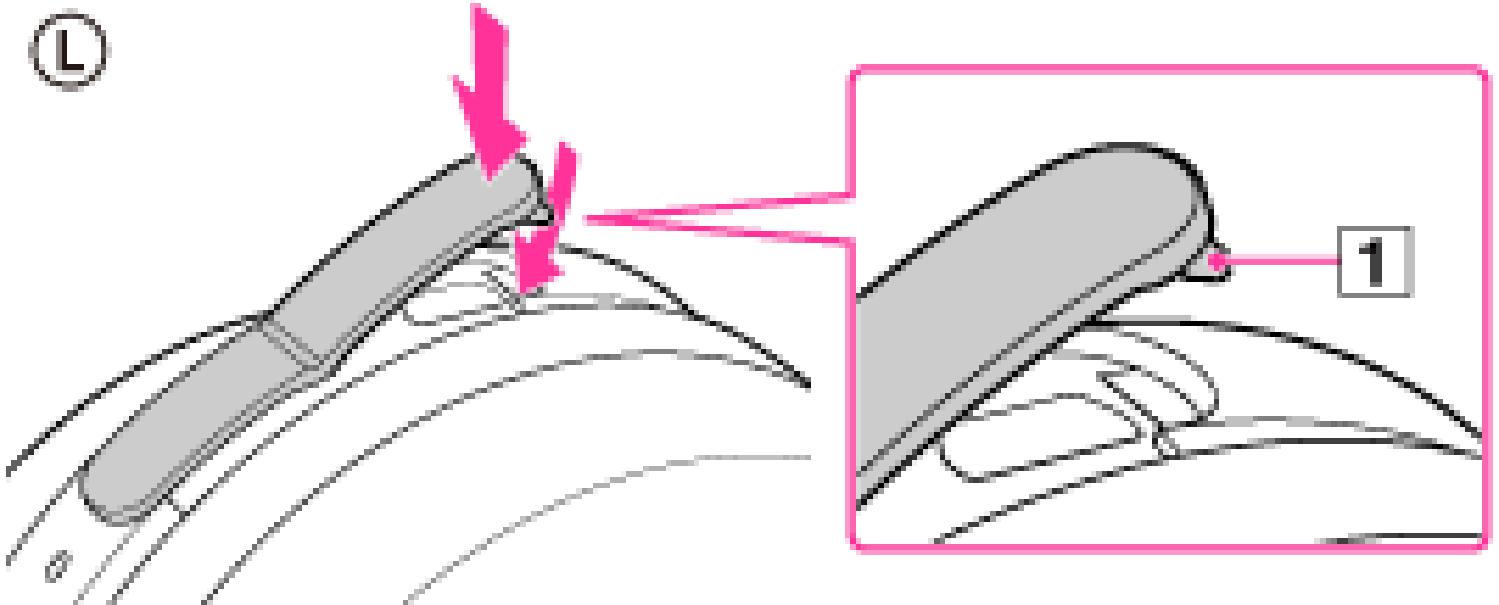

1 Catch

Tips

- If the micro-USB cable is connected to a computer while the headset is turned on, the headset will be turned off automatically.
- To charge the headset from an AC outlet, use USB Charging AC Power Adaptor* (sold separately). For details, refer to the manuals supplied with the USB Charging AC Power Adaptor.
- The headset cannot be turned on while charging the battery.

* Refer to the Reference Guide on the recommended adapter.

Caution

If the headset detects a problem while charging, the indicator (red) may turn off, although charging is not complete.

Check for the following causes:

- Ambient temperature exceeds the range of 5 °C – 35 °C (41 °F – 95 °F).
- There is a problem with the battery.

In this case, charge again within the above-mentioned temperature range. If the problem persists, consult your nearest Sony dealer.

Notes

- If the headset is not used for a long time, the battery may be quickly depleted, however, after a few recharges, the battery life will improve.
- Even if you do not intend to use the headset for a long time, charge the battery to its full capacity once every 6 months to maintain its performance.
- If the headset is not used for a long time, it may take longer to charge the battery.
- If the life of the built-in rechargeable battery drops to half the normal length, the battery should be replaced. Consult your nearest Sony dealer for replacement of the rechargeable battery.
- Avoid exposure to temperature extremes, direct sunlight, moisture, sand, dust or mechanical shock. Never leave the headset in a car parked in the sun.
- If the computer enters into hibernation mode while connected to the headset, charging will not be completed properly. Check the setting of the computer before charging. The indicator (red) will go off automatically even if the computer enters into hibernation mode. Charge the headset again in this case.
- Use the supplied micro-USB cable only, and connect directly to a computer. Charging will not be completed properly by an indirect connection, such as via a USB hub.

Usage hours

Status	Approx. usage hours

Communication time (including music playback time) (up to)	30 hours
Standby time (up to)	200 hours

The communication time will be about 15 hours when it is charged for 2 hours. Time stated above may vary, depending on ambient temperature or conditions of use.

Checking the remaining battery

If you press the POWER button while the headset is turned on, the indicator (red) flashes. You can check the remaining battery by the number of times the indicator (red) flashes. The indicator (red) flashes immediately after the headset is turned on to indicate the remaining battery power.

Indicator (red)	Status
3 times	Full
2 times	Mid
1 time	Low (needs to charge)

Note

- You cannot check the remaining battery during pairing operation.

When the battery is almost empty

The indicator turns red. When the battery becomes empty, the headset sounds a beep and turns off automatically.



What is BLUETOOTH wireless technology?

Bluetooth® wireless technology is a short-range wireless technology that enables wireless data communication between digital devices, such as a computer or digital camera. BLUETOOTH wireless technology operates within a range of about 10 meters (about 30 feet).

Connecting 2 devices as necessary is common, but some devices can be connected to multiple devices at the same time.

You do not need to use a cable for connection, nor is it necessary for the devices to face one another, such is the case with infrared technology. For example, you can use such a device in a bag or pocket.

BLUETOOTH standard is an international standard supported by thousands of companies all over the world, and employed by various companies worldwide.

Communication System and Compatible BLUETOOTH Profiles of the headset

Profile is standardization of the function for each BLUETOOTH device specification. The headset supports the following BLUETOOTH version and profiles:

Communication System :

BLUETOOTH Specification Ver. 3.0

Compatible BLUETOOTH Profiles:

- A2DP (Advanced Audio Distribution Profile): Transmitting or receiving audio content of high-quality.
- AVRCP (Audio Video Remote Control Profile): Controlling A/V equipment; pausing, stopping, starting playback, etc.
- HSP (Headset Profile)*: Talking on the phone/Operating the phone.
- HFP (Hands-free Profile)*: Talking on the phone/Operating the phone by

hands-free.

- * When you use a BLUETOOTH mobile phone supported by both HFP (Hands-free Profile) and HSP (Headset Profile), set it to HFP.

Notes

- To use the BLUETOOTH function, the BLUETOOTH device to be connected requires the same profile as that of the headset. Even if the device has the same profile, functions may vary depending on the specifications.
 - Due to the characteristic of BLUETOOTH wireless technology, the sound played on the headset is slightly delayed from the sound played on the BLUETOOTH device during talking on the telephone or listening to the music.
 - Do not use the BLUETOOTH function on an airplane. The radio waves may cause malfunction of the airplane and result in hazardous accidents. Connect the headset with other devices by using the supplied cord.
-

Copyright 2012 Sony Corporation



What you can do with BLUETOOTH function

The headset uses BLUETOOTH wireless technology. You can enjoy music wirelessly from a smartphone, mobile phone, or music player. Also, you can make or receive a call by operating the headset.

Listening to music

You can enjoy music wirelessly from a smartphone, mobile phone, or music player.

[\[Details\]](#)

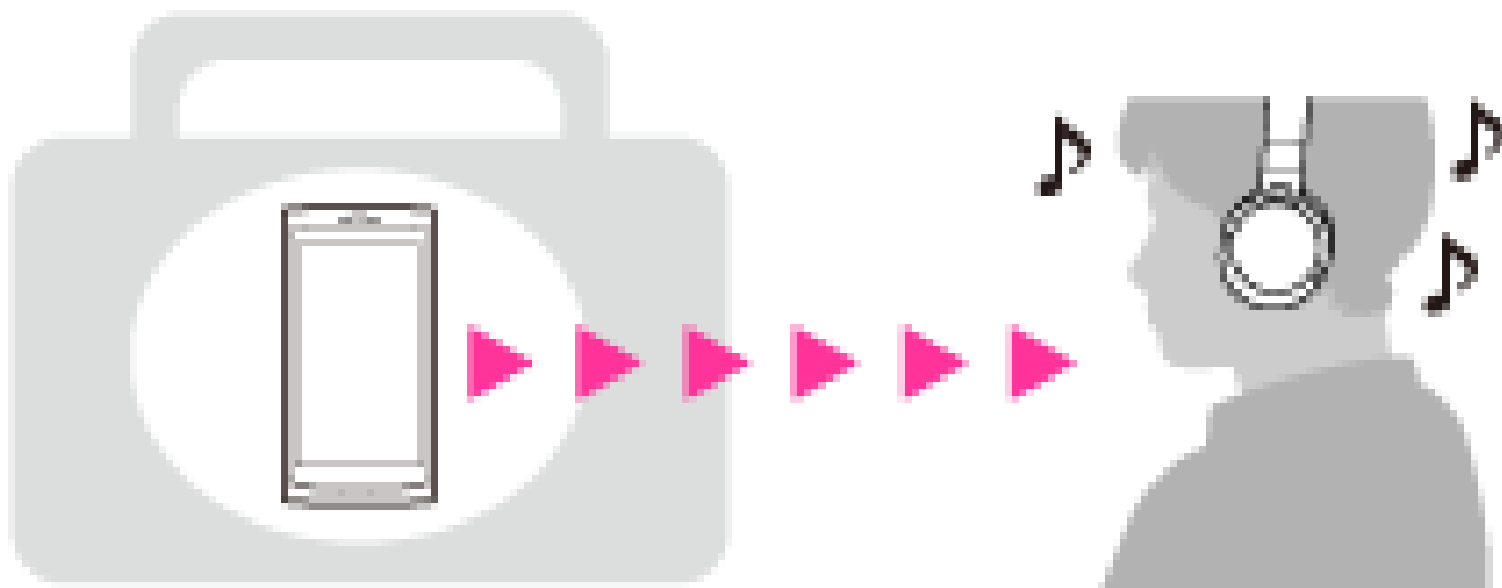

Talking on the phone

You can make and receive a call with your hands free, while leaving your smartphone or mobile phone in your bag or pocket. [\[Details\]](#)

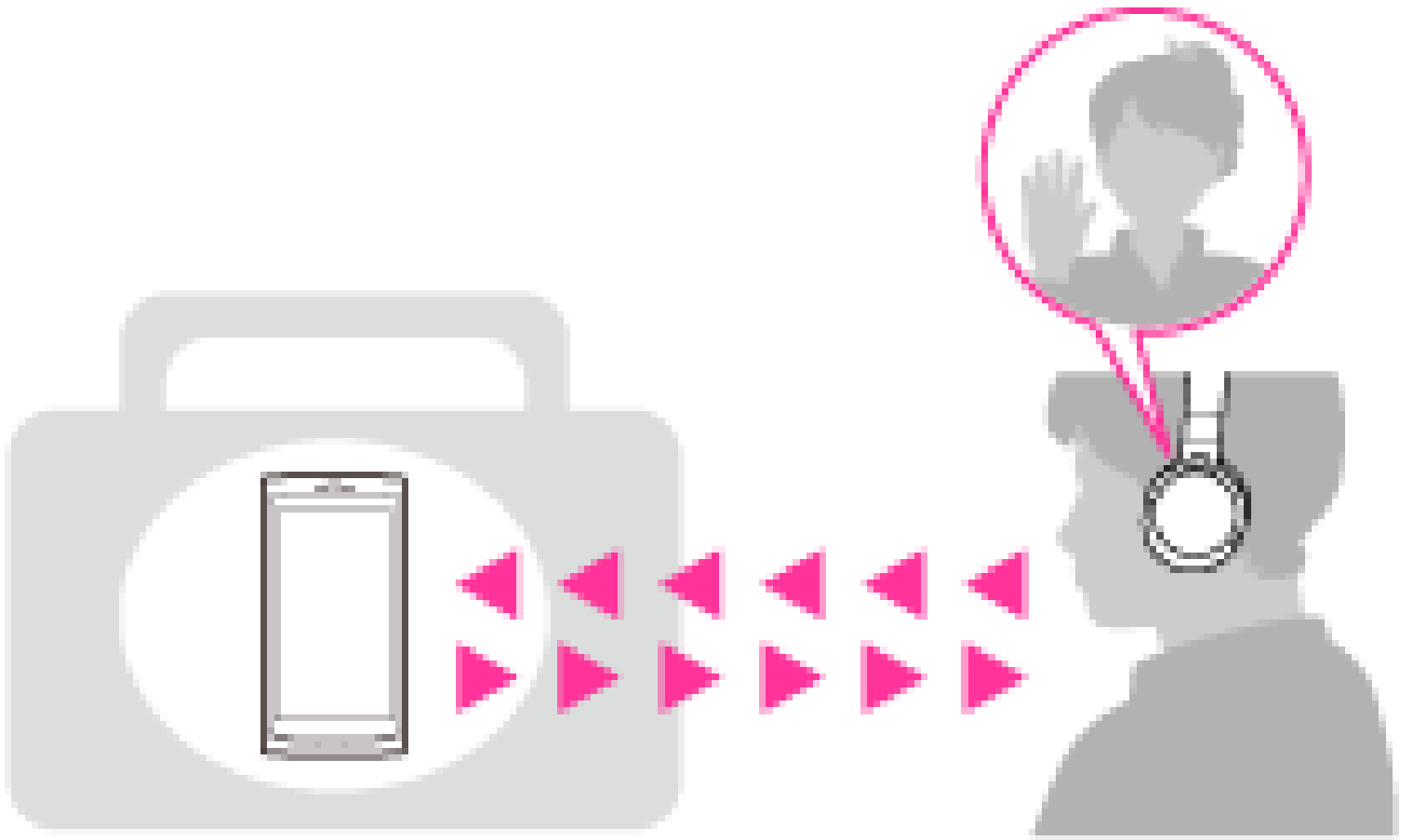

Copyright 2012 Sony Corporation



Steps to BLUETOOTH function

To listen to music played, or make a call on a BLUETOOTH smartphone or mobile phone, follow the steps below.

1. Register (pair) a BLUETOOTH device (smartphone, mobile phone, etc.) and the headset with each other.

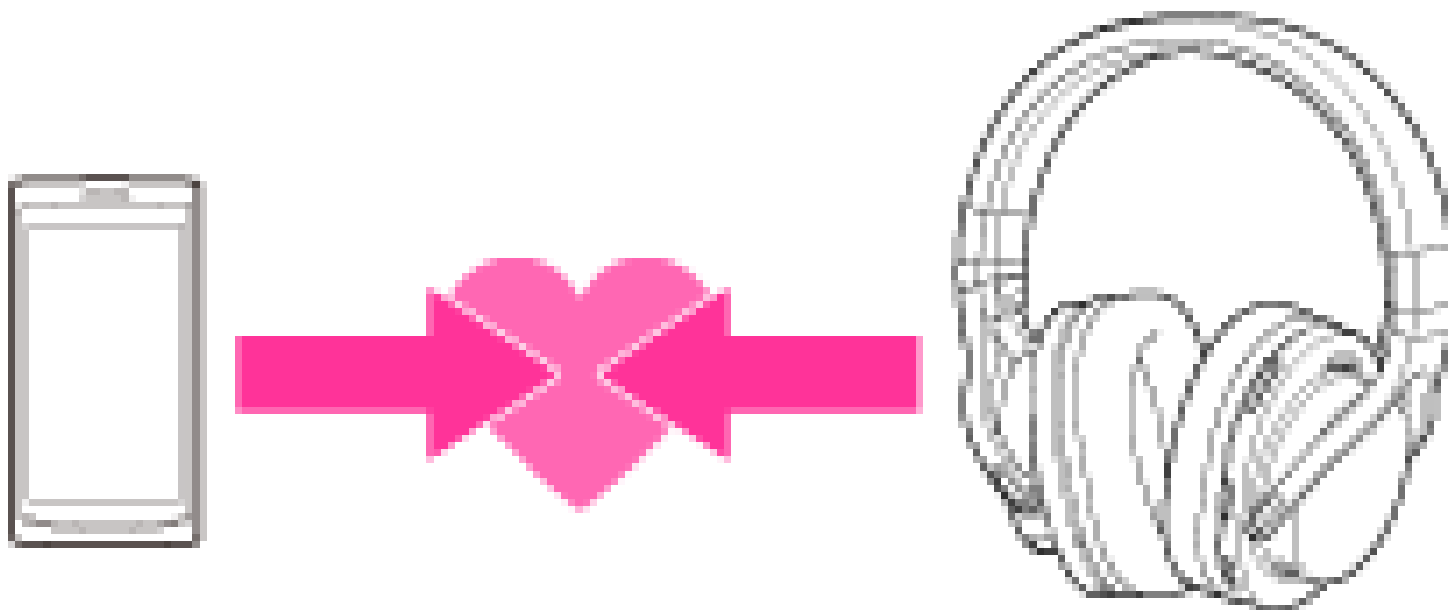

2. Operate the BLUETOOTH device to make a BLUETOOTH connection.

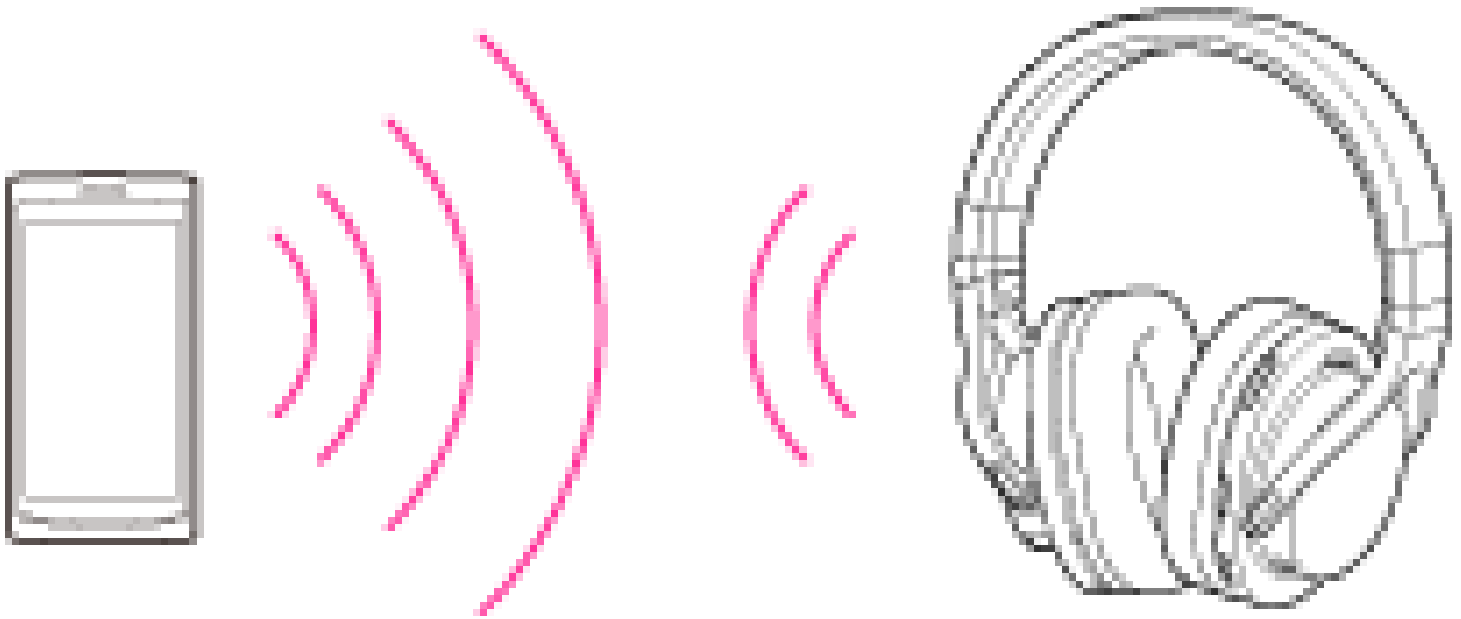

3. Listen to music played on the BLUETOOTH device, or make and receive a call by operating the headset.

The headset supports the following BLUETOOTH version and profiles:

Communication System :

BLUETOOTH Specification Ver. 3.0

Compatible BLUETOOTH Profiles:

- A2DP (Advanced Audio Distribution Profile): Transmitting or receiving audio content of high-quality.
- AVRCP (Audio Video Remote Control Profile): Controlling A/V equipment; pausing, stopping, starting playback, etc.
- HSP (Headset Profile)*: Talking on the phone/Operating the phone.
- HFP (Hands-free Profile)*: Talking on the phone/Operating the phone by hands-free.

* When you use a BLUETOOTH smartphone or mobile phone supported by both HFP (Hands-free Profile) and HSP (Headset Profile), set it to HFP.

Notes

- To use the BLUETOOTH function, the BLUETOOTH device to be connected requires the same profile as that of the headset. Even if the device has the same profile, functions may vary depending on the specifications.
- Due to the characteristic of BLUETOOTH wireless technology, the sound played

on the headset is slightly delayed from the sound played on the BLUETOOTH device during talking on the telephone or listening to the music.

- Do not use the BLUETOOTH function on an airplane. The radio waves may cause malfunction of the airplane and result in hazardous accidents. Connect the headset with other devices by using the supplied cord.
-

Copyright 2012 Sony Corporation



Pairing and connecting with a BLUETOOTH device

1. Place the BLUETOOTH device within 1 meter (3 feet) of the headset.
2. Enter pairing mode on the headset.
Press and hold the POWER button for more than 7 seconds while the headset is turned off.

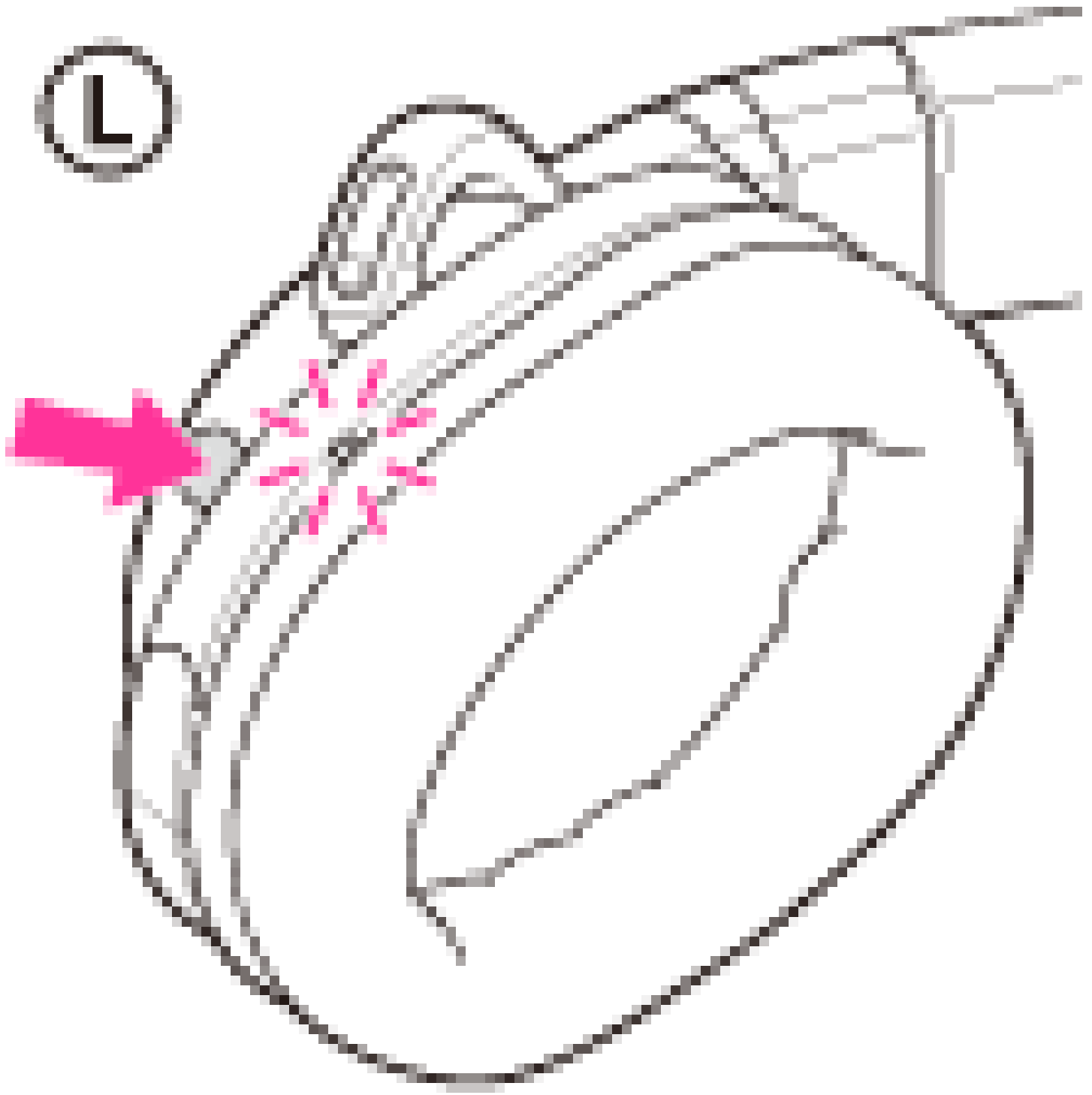

Make sure that the indicator flashes blue and red alternately after you release the button.

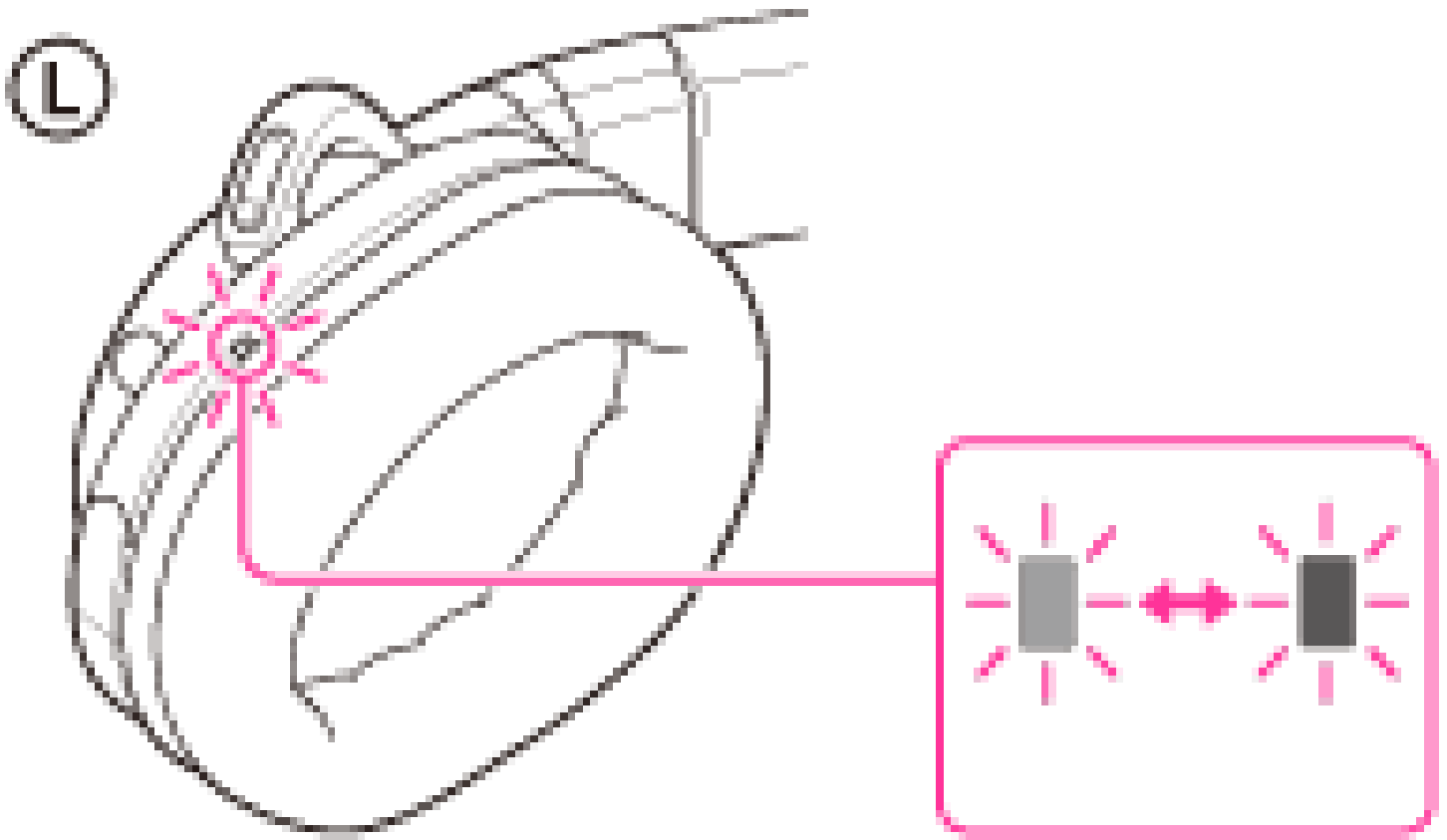

Note

- If pairing is not established within about 5 minutes, pairing mode will be cancelled and the headset will turn off. In this case, start over from step 1.

3. Perform the pairing procedure on the BLUETOOTH device to detect the headset.

When the list of detected devices appears on the display of the BLUETOOTH device, select “MDR-1RBT.”

If “MDR-1RBT” is not displayed, repeat from step 1.

If passkey input is required on the display of a BLUETOOTH device, input “0000.”

A Passkey may be called a “Passcode,” a “PIN code,” a “PIN number,” or a “Password.”

4. Make the BLUETOOTH connection from the BLUETOOTH device.

Tips

- To pair with other BLUETOOTH devices, repeat steps 1 to 4 for each device.
- To delete all pairing information, see “What can I do to solve a problem?”

[\[Details\]](#)

Notes

- For details, refer to the operating instructions supplied with the BLUETOOTH device.
- When pairing with a BLUETOOTH device that cannot display a list of detected devices or that has no display, you may pair the device by setting both the headset and the BLUETOOTH device to pairing mode. At this time, if passkey is set besides “0000” on the BLUETOOTH device, pairing cannot be done with the headset.
- Once BLUETOOTH devices are paired, there is no need for pairing again, except in the following cases:
 - Pairing information is deleted after repair, etc.
 - The headset is paired with 9 or more devices. The headset can be paired with up to 8 devices; if a new device is paired after 8 devices have been paired, the device whose latest connection time is the oldest among the 8 paired devices is replaced by the new one.
 - When recognition of the headset by the device to be connected is deleted.
 - The headset is initialized. All pairing information is deleted.

Copyright 2012 Sony Corporation



Connecting with the paired device

1. Turn on the headset.

Press and hold the POWER button for about 2 seconds while the headset is turned off.

L

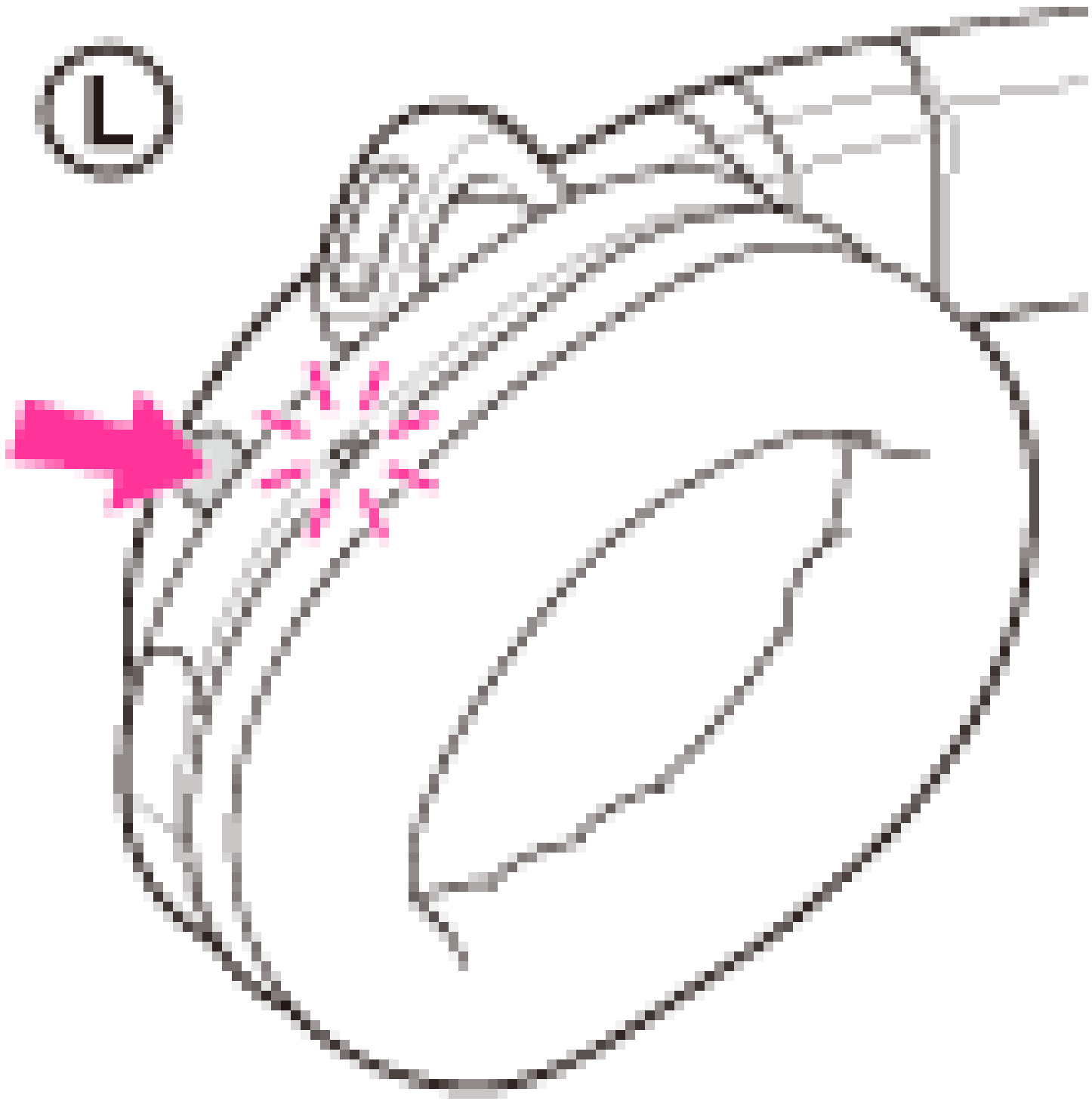

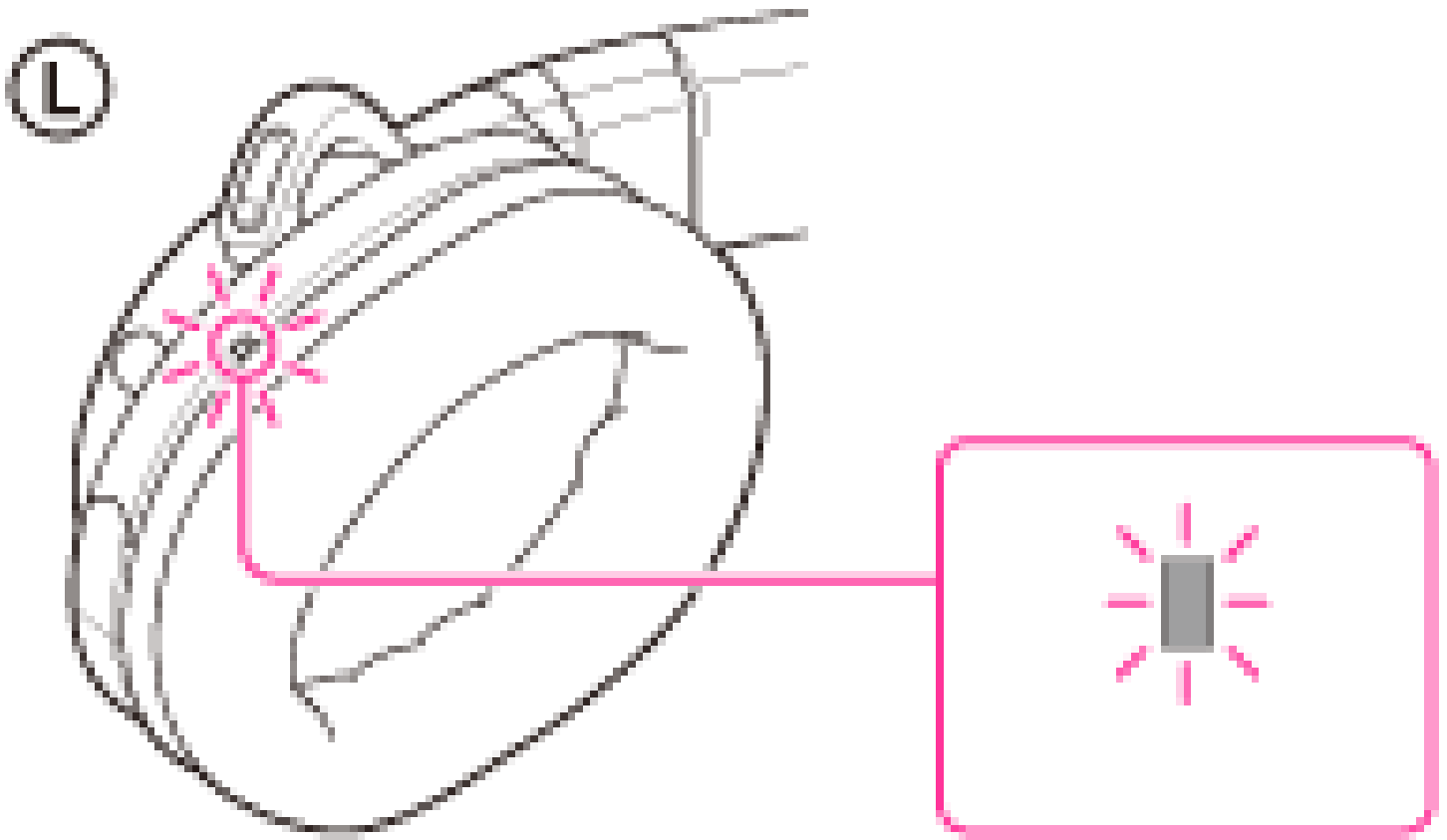



The headset may be connected with the BLUETOOTH device as soon as you turn on both devices.

2. Make the BLUETOOTH connection from the BLUETOOTH device.

Tip

- If you have previously connected this BLUETOOTH device, you can make an HFP/HSP connection by pressing the  button, or an A2DP connection by pressing the  button, when the headset is turned on.



Indications of BLUETOOTH function

The indicator flashes in red or blue to indicate the BLUETOOTH connection status.

Status	Flashing pattern ○ : blue/ ● : red
Pairing mode	○●○●○●○●○●○●...
Connectable	○--○--○--○--○--○--○...
Connecting	○○-○○-○○-○○-○○-○○-...
Connected (HFP/HSP or A2DP)	○-----○-----...
Connected (HFP/HSP and A2DP)	○-○-----○-○-----...
Playing music or During a call (Connected HFP/HSP or A2DP)	○○-----○○-----...
Playing music or During a call (Connected HFP/HSP and A2DP)	○○○-----○○○-----...
Incoming call	○○○○○○○○○○○○○○○○○○...

When the remaining battery power becomes low, the indicator turns from blue to red, except for pairing mode.



Compatible smartphones

NFC (Near Field Communication) is a technology enabling short-range wireless communication between various devices, such as mobile phones and IC tags. Thanks to the NFC function, data communication can be achieved easily just by touching the relevant symbol or designated location on NFC compatible devices. By using the NFC function, the headset is turned on automatically and then paired and connected with a BLUETOOTH device.

Compatible smartphones

- Smartphones with the NFC function built-in (OS: Android 2.3.3 or later, excluding Android 3.x)
-



Preparation on the smartphone

An app for the NFC function needs to be installed on the smartphone. Download the app “NFC Easy Connect” from the Google Play, and install it. The App may not be available in some countries and/or regions.

1. Download and install the app “NFC Easy Connect.”

Access the following Web site:

<https://play.google.com/store/apps/details?id=com.sony.easyconnect>

By the two-dimensional code:

Use a two-dimensional code reader app.



2. Set the smartphone so that the NFC function can be used.
For details, refer to the manual of the smartphone.



About “NFC Easy Connect” App

“NFC Easy Connect” is Sony’s original app for Android Phone available at Google Play Store.

To find out more about the functions, search for “NFC Easy Connect” and download the free app.

The App may not be available in some countries and/or regions.



Connecting with the smartphone by one touch

By touching the headset with the smartphone, the headset is turned on automatically and then proceeds to pairing and BLUETOOTH connection.

1. Set the NFC switch to ON on the headset.

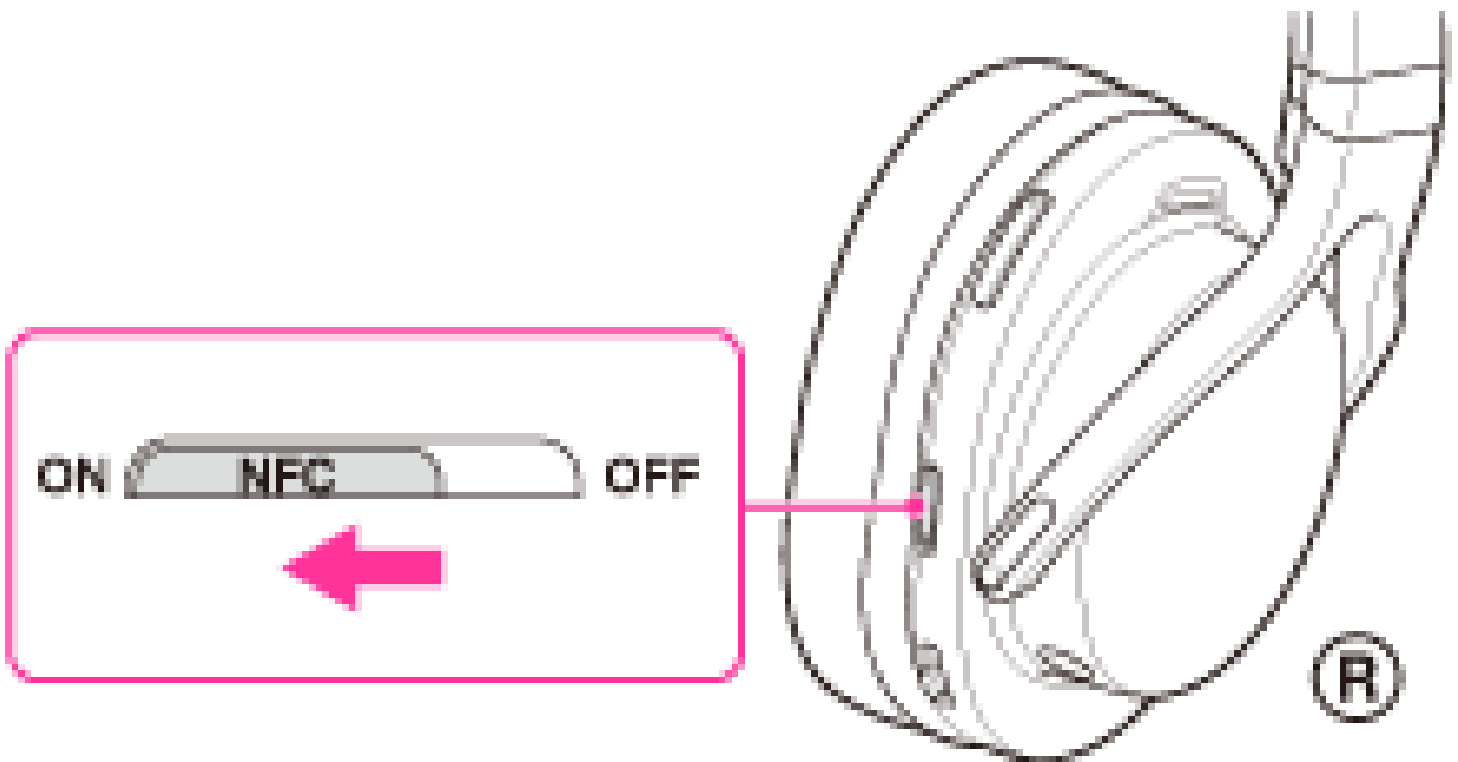

2. Start the app “NFC Easy Connect” on the smartphone.
Make sure that the application screen is displayed.
3. Touch the headset with the smartphone.
Touch the smartphone on the N marked part of the headset.
Keep touching the headset with the smartphone until the smartphone vibrates.

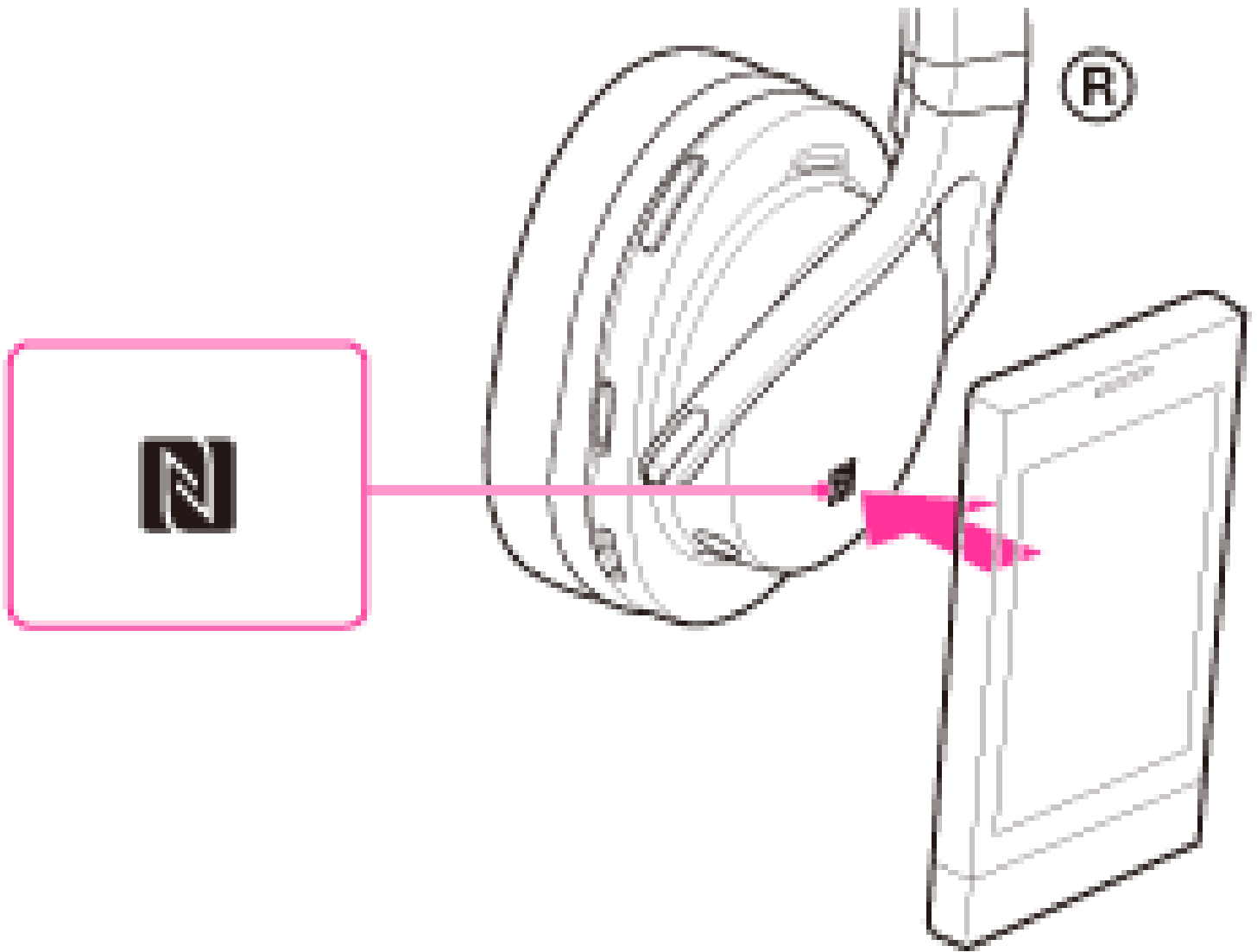

Follow the on-screen instructions to complete the connection.
Refer to the manual of the smartphone for the designated location to be touched on the smartphone.

Note

- When the NFC switch is set to OFF, you cannot make a connection. You may set the switch to OFF to prevent the headset from turning on or connecting with other devices if you touch the headset with other device unintentionally. However, if you set the switch to OFF when the headset is connected with another device, you can disconnect the headset from the device by touching the headset with the device.



Disconnecting the smartphone by one touch

You can disconnect the headset from the smartphone by touching the headset with it.

1. Touch the headset with the smartphone.
Touch the smartphone on the N marked part of the headset.

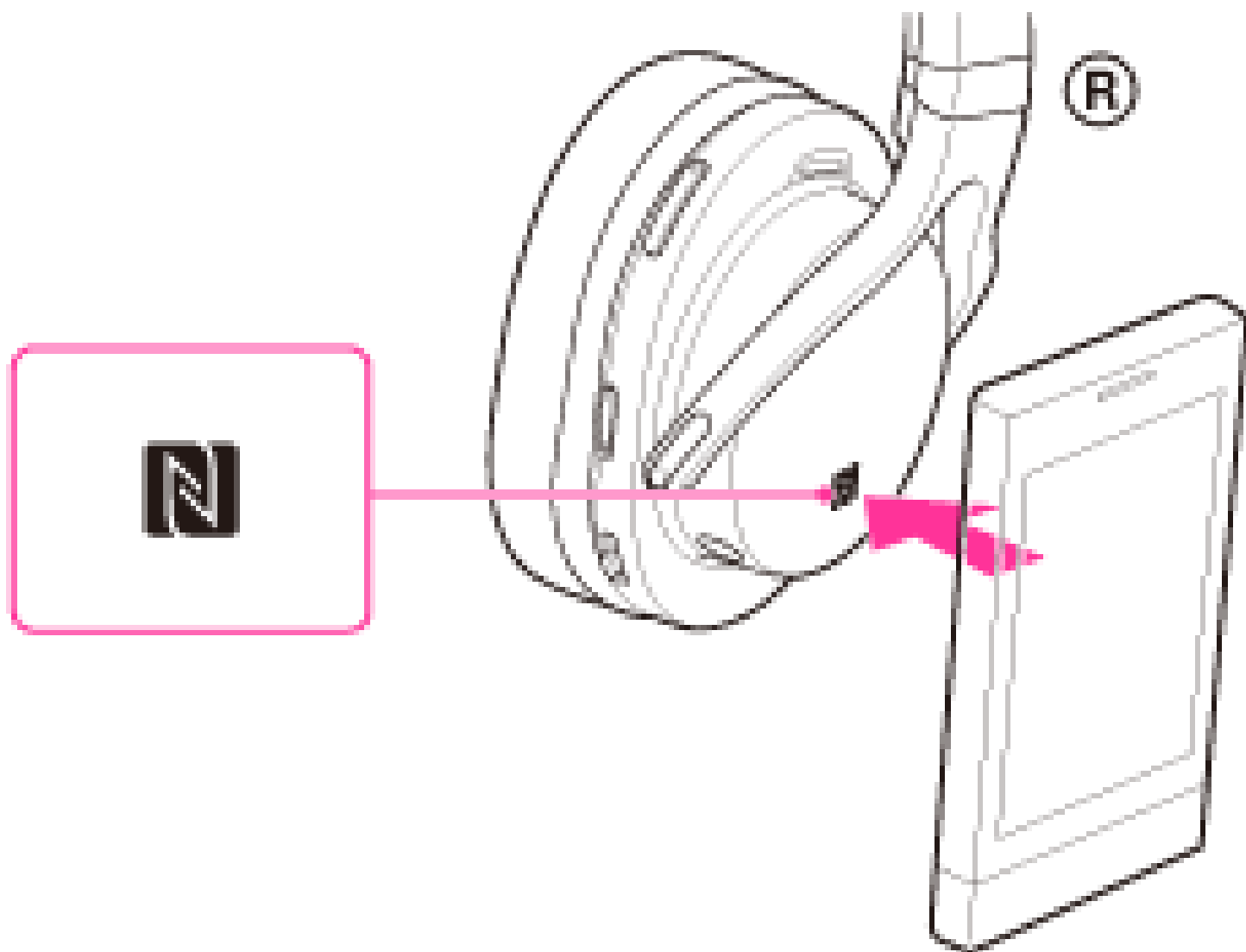

Copyright 2012 Sony Corporation



Switching the device by one touch

- When the headset is connected with a BLUETOOTH device, if you touch an NFC compatible smartphone on the headset, the headset is connected with the smartphone that touched on the headset most recently.
 - If you touch the smartphone that is connected with the headset on another NFC compatible BLUETOOTH headset or BLUETOOTH speaker, the smartphone is disconnected from the headset, and connected with the BLUETOOTH device touched.
-



Listening to music

You can enjoy listening to music and basic remote control operation of a BLUETOOTH device via a BLUETOOTH connection. The BLUETOOTH device is required to support the following BLUETOOTH profiles.

- A2DP (Advanced Audio Distribution Profile): enables you to enjoy high-quality audio content wirelessly.
- AVRCP (Audio Video Remote Control Profile): enables you to enjoy basic remote control operation (play, stop, etc.) of a BLUETOOTH device.

The headset supports SCMS-T content protection. You can enjoy music, etc., from a device such as a mobile phone or portable TV that supports SCMS-T content protection.

1. Connect the headset with a BLUETOOTH device.
2. Wear the headset.

Extend the headband to adjust the length.

Put the unit with **L** indication on your left ear and **R** indication on your right ear, then place the headset over your head. The **L** side has a tactile dot.

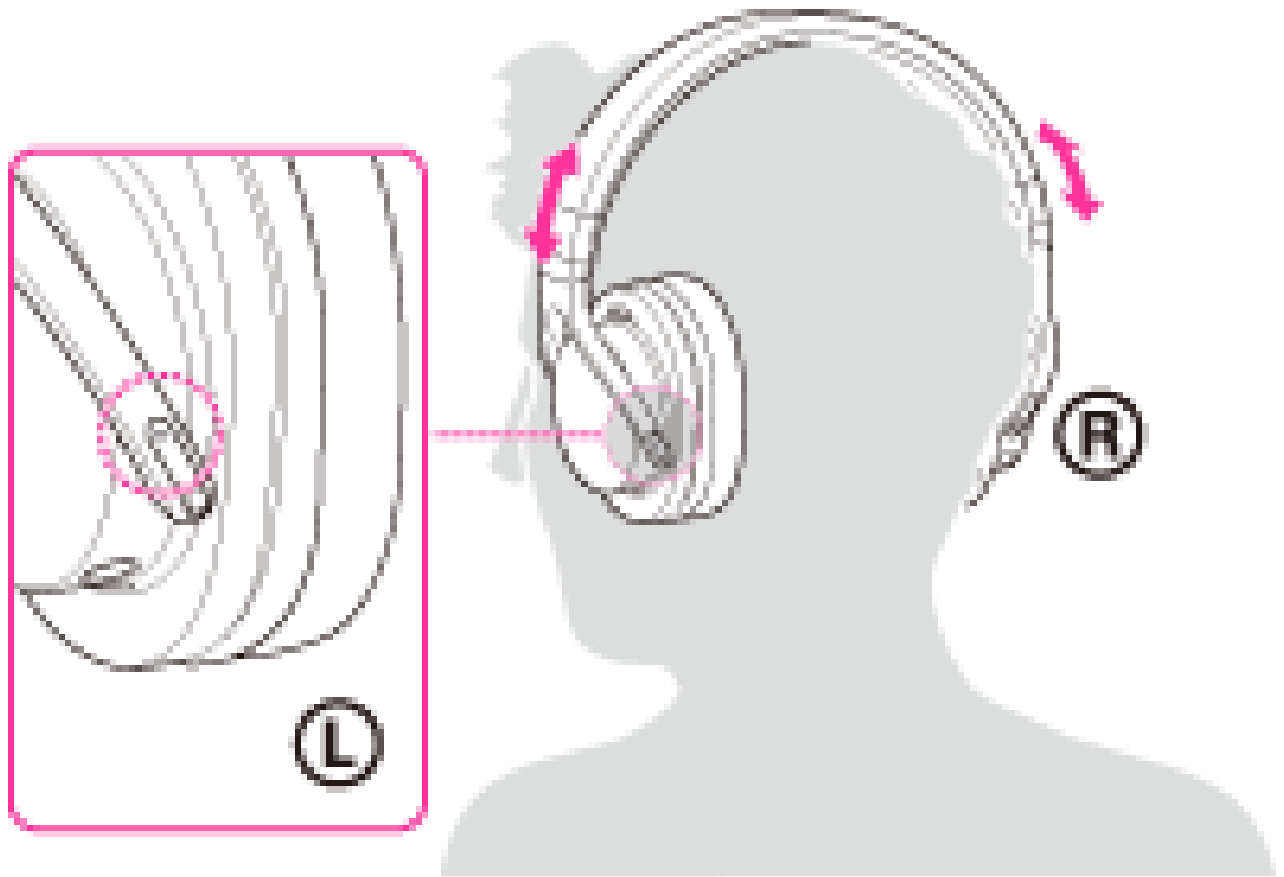

3. Play back music or video on the BLUETOOTH device.

Tip

- Depending on the BLUETOOTH device, it may be necessary to adjust the volume or set the audio output setting on the connected device.

After use

1. Terminate the BLUETOOTH connection by operating the BLUETOOTH device.
2. Press and hold the POWER button for about 2 seconds.
The indicator (blue) goes off and the headset turns off.

Tip

- When you finish playing music, the BLUETOOTH connection may terminate automatically, depending on the BLUETOOTH device.

Related topic

[Pairing and connecting with a BLUETOOTH device](#)

Copyright 2012 Sony Corporation



Controlling the audio device

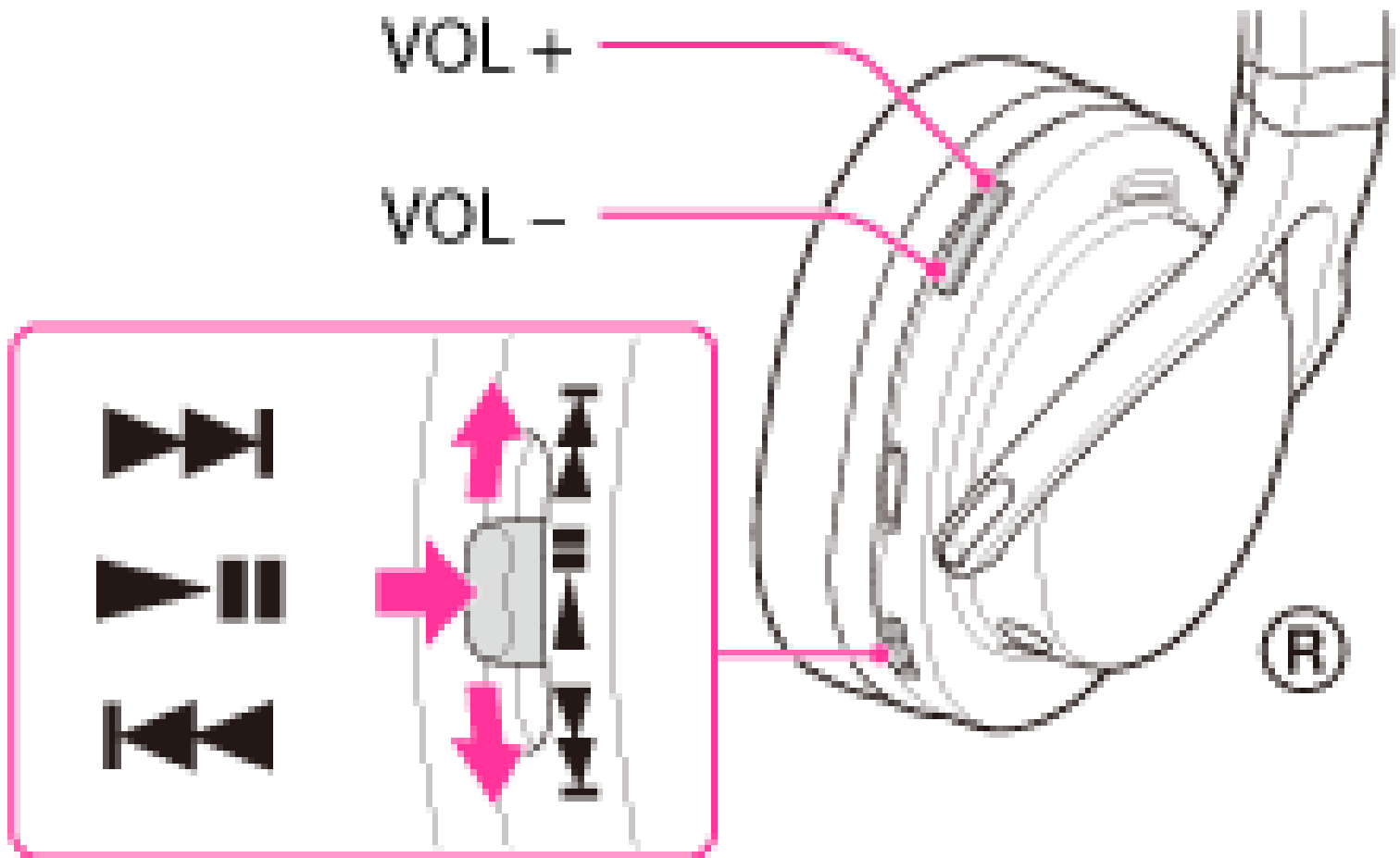

If the BLUETOOTH device supports AVRCP, you can control it by the buttons on the headset. The functions available may vary depending on the BLUETOOTH device. Refer to the manual supplied with your BLUETOOTH device.



To adjust the volume

Press the VOL+/- button.

Buttons	Function
---------	----------

	<ul style="list-style-type: none">• Press once during pause to start playback.• Press and hold for 2 seconds during playback to stop.• Press once during playback to pause.
	<ul style="list-style-type: none">• Rotate once to skip to the next/previous song.• Rotate and hold to fast-forward/fast-rewind a song.

Note

- If the communication condition is poor, the BLUETOOTH device may react incorrectly to the operation on the headset.
-

Copyright 2012 Sony Corporation



Using the headset by connecting the supplied cord

You can use the headset as an ordinary wired headphones by connecting the supplied cord.

1. Open the cover of the INPUT jack.

Insert the tip of your fingernail into the groove, and open the cover.

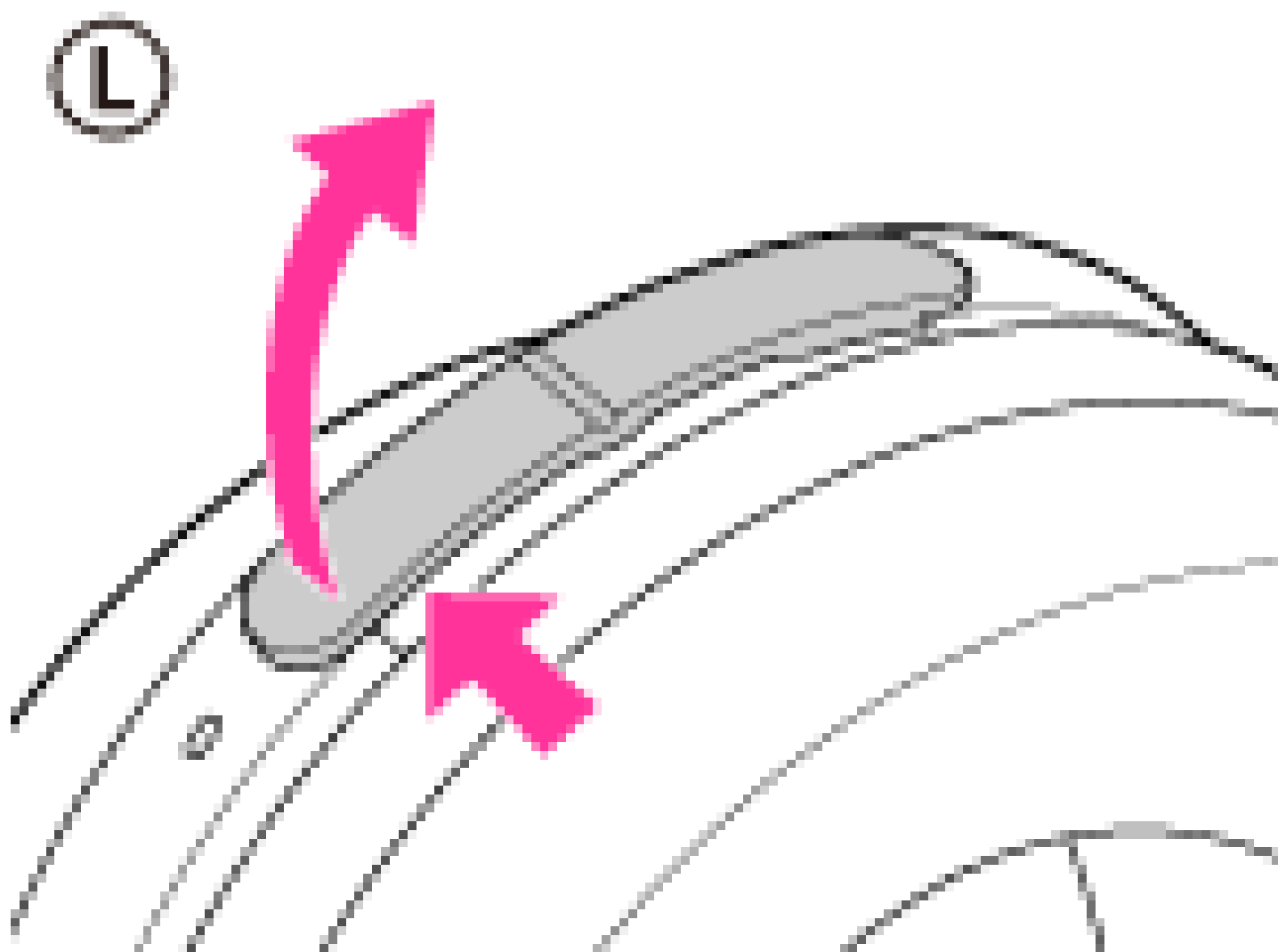

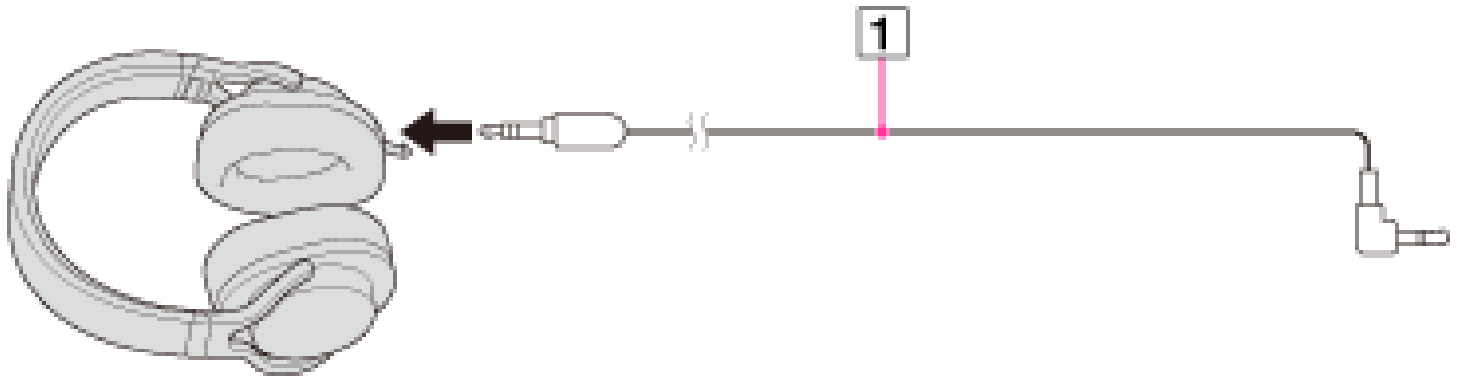

2. Connect the supplied cord.



1 Supplied cord

Notes

- Use the supplied cord only.
- The BLUETOOTH function is disabled when the cord is connected.
- You cannot use the POWER button,  button,  button,  buttons, or microphone when the cord is connected.

When there is an incoming call

When an incoming call arrives, a ring tone will be heard via the headphones. Accept the call using your smartphone or mobile phone, and talk using the microphone of the phone. You can hear the voice of the caller from the headphones.

If you disconnect the cord from the smartphone or mobile phone, you can talk using the microphone and speaker of the phone.

To close the cover of the INPUT jack

Push the catch at the edge (the round part) of the cover into the jack compartment.

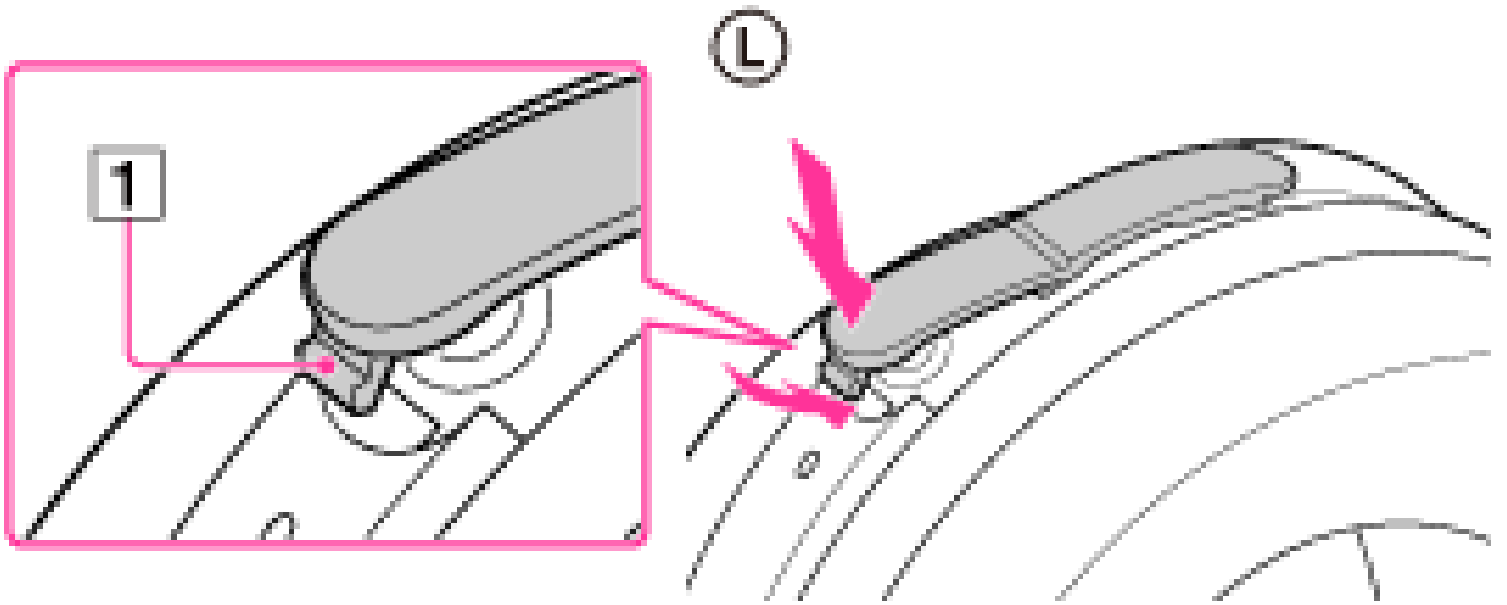

1 Catch

Copyright 2012 Sony Corporation



Making a call



You can enjoy a hands-free call with a BLUETOOTH smartphone or mobile phone that supports the BLUETOOTH profile HFP (Hands-free Profile) or HSP (Headset Profile), via a BLUETOOTH connection.

If your BLUETOOTH smartphone or mobile phone supports both HFP and HSP, set it to HFP.

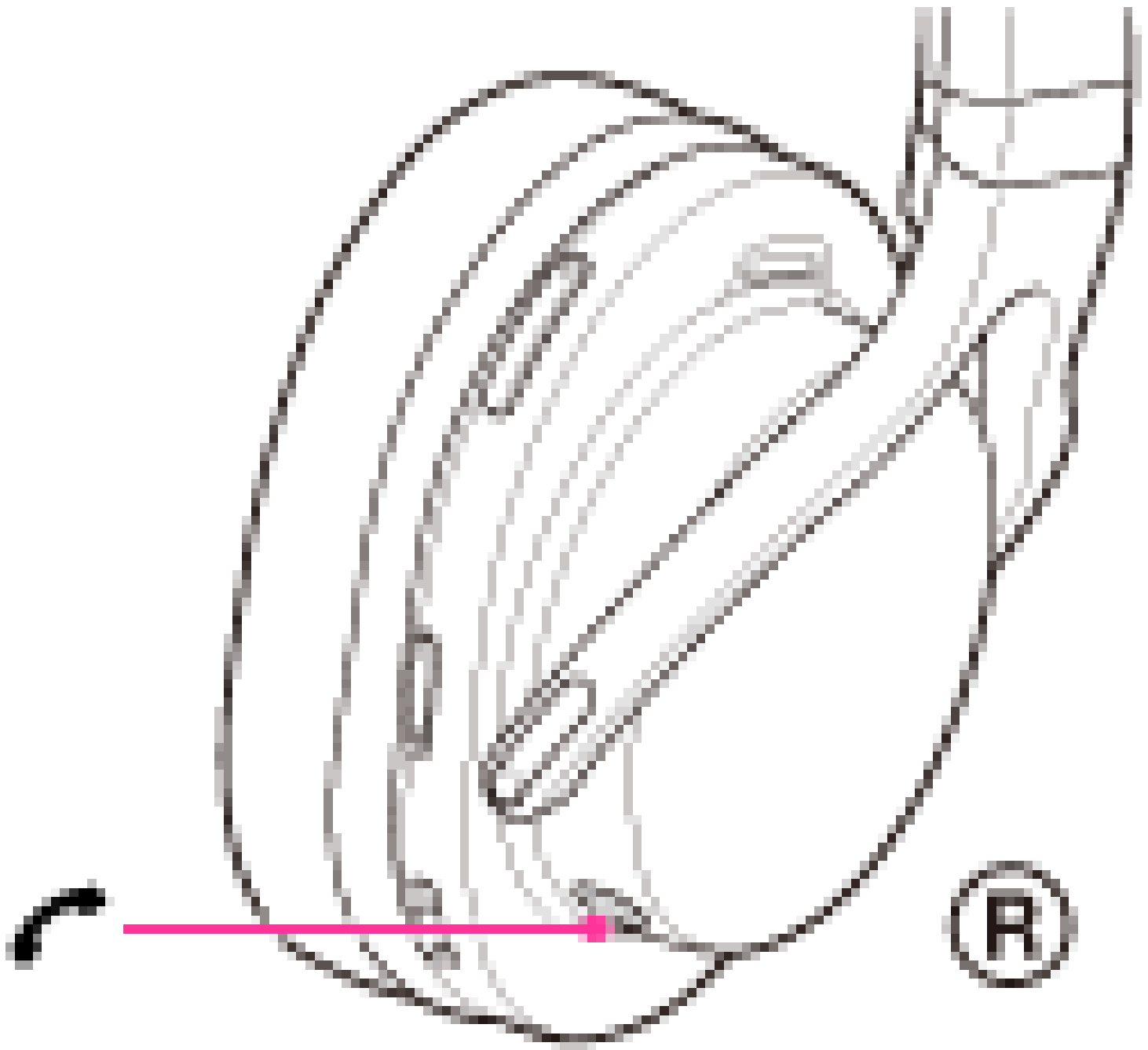
1. Connect the headset with a BLUETOOTH smartphone or mobile phone.
2. Use the buttons on your smartphone or mobile phone when making a call.
If no dial tone is heard via the headset, switch the call device to the headset using your smartphone or mobile phone. With an HFP connection, you can do this by pressing the  button on the headset for about 2 seconds.
Refer to the manual supplied with your smartphone or mobile phone for the details of the operation.



Tip

- With an HFP connection, you can call in the following way, depending on the smartphone or mobile phone. Refer to the manual supplied with your smartphone or mobile phone for the details of the operation.
 - When not talking, you can call using the voice dial function by pressing the  button.
 - You can call the last dialed number by pressing the  button for about 2 seconds.

Note

- Some mobile phones may not dial the requested number due to an incompatible voice dial function. Refer to the manual supplied with the mobile phone for details of the voice dial function.

To adjust the volume

Press the VOL+/- button.

Tips

- You cannot adjust the volume when not talking.
- Volume for a call and listening to music can be adjusted independently. Even if you change the volume while playing back the music, the volume of a call does not change.

To end a call

Press the  button on the headset.

After use

1. Disconnect the BLUETOOTH connection using the smartphone or mobile phone.
2. Press and hold the POWER button on the headset for about 2 seconds. The indicator (blue) goes off, and the headset turns off.

Related topic

[Pairing and connecting with a BLUETOOTH device](#)



Receiving a call

When an incoming call arrives, a ring tone will be heard via the headset. The ring tone differs in the following ways, depending on your smartphone or mobile phone.

- ring tone set on the headset
- ring tone set on the smartphone or mobile phone
- ring tone set on the smartphone or mobile phone only for a BLUETOOTH connection

1. Connect the headset with a BLUETOOTH device.
2. Press the  button on the headset.

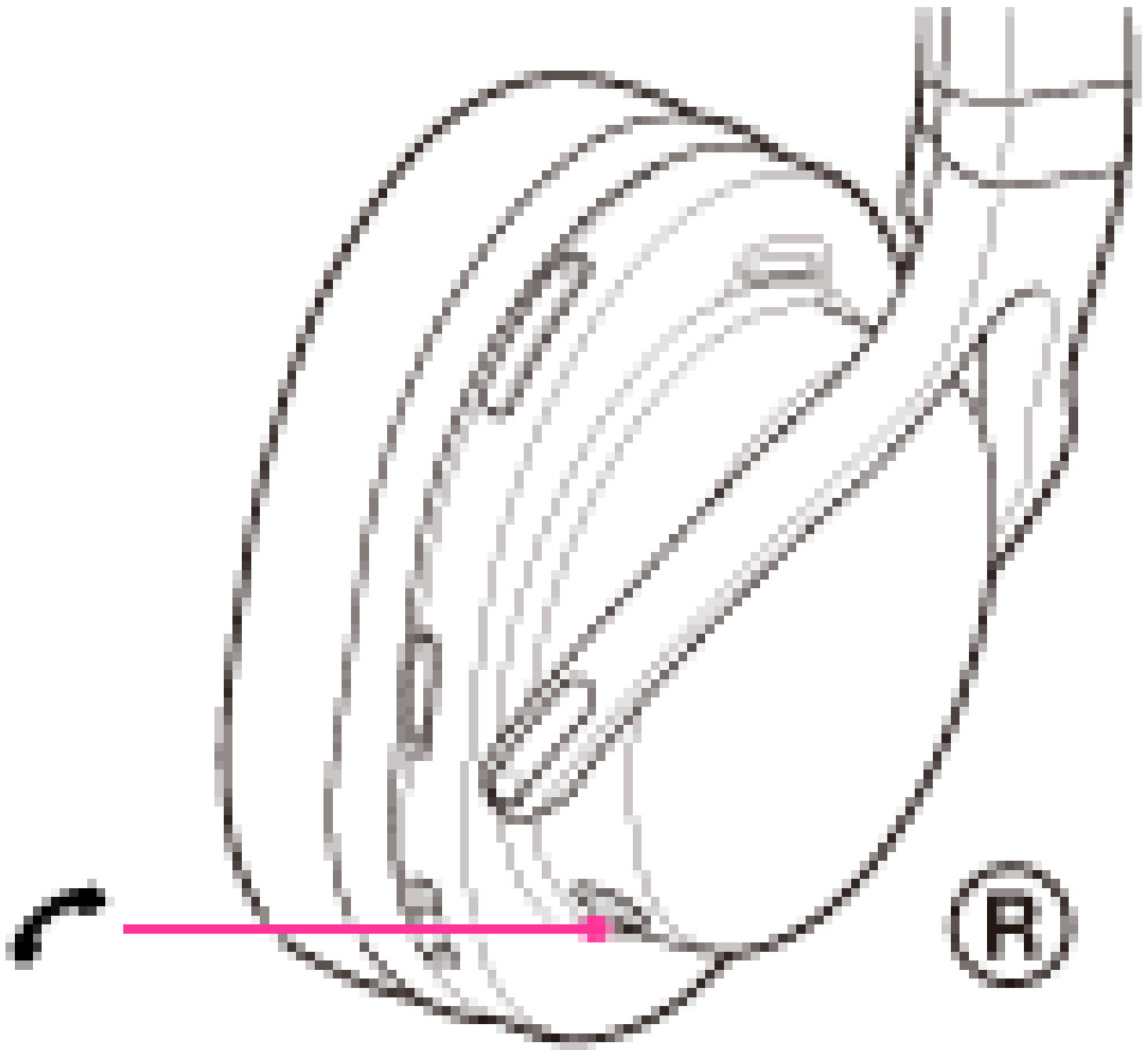

Note

- If you received a call using your smartphone or mobile phone, some smartphones or mobile phones may have handset use priority. In the case of the HFP connection, talk on the headset by pressing the  button on the headset for about 2 seconds, or using your smartphone or mobile phone. For details, refer to the manual supplied with your smartphone or mobile phone.

To adjust the volume

Press the VOL+/- button.

Tips

- You cannot adjust the volume when not talking.
- Volume for a call and listening to music can be adjusted independently. Even if you change the volume while playing back the music, the volume of a call does not change.

To end a call

Press the  button on the headset.

After use

1. Disconnect the BLUETOOTH connection using the smartphone or mobile phone.
2. Press and hold the POWER button on the headset for about 2 seconds. The indicator (blue) goes off, and the headset turns off.

Copyright 2012 Sony Corporation



Controlling the smartphone or mobile phone

The function available may vary depending on the profile supported by your BLUETOOTH smartphone or mobile phone. Even if the phone has the same profile, functions may vary depending on the specifications. Refer to the manual supplied with your smartphone or mobile phone.

Supported profile: HFP

Status	 button
Standby	<ul style="list-style-type: none"> • Press once to start voice dial. • Press for about 2 seconds to redial.
Voice dial active	<ul style="list-style-type: none"> • Press once to cancel voice dial.
Outgoing call	<ul style="list-style-type: none"> • Press once to cancel outgoing call. • Press for about 2 seconds to change call device between the headset and the smartphone or mobile phone.
Incoming call	<ul style="list-style-type: none"> • Press once to answer call. • Press for about 2 seconds to reject call.
During call	<ul style="list-style-type: none"> • Press once to finish call. • Press for about 2 seconds to change call device between the headset and the smartphone or mobile phone.

Note

- Some mobile phones may not dial the requested number due to an incompatible voice dial function, Refer to the manual supplied with the mobile phone for

details of the voice dial function.

Supported profile: HSP

Status	 button
Outgoing call	• Press once to cancel outgoing call.
Incoming call	• Press once to answer call.
During call	• Press once to finish call.

Copyright 2012 Sony Corporation



Making a call while playing back music (Multi point connection)

To call using a BLUETOOTH smartphone or mobile phone while listening to music played on another BLUETOOTH compatible music player, the headset needs to be connected with each device with a BLUETOOTH connection.

1. Make an A2DP BLUETOOTH connection between the headset and the BLUETOOTH music device (music player, etc.).
2. Make an HFP or HSP BLUETOOTH connection between the headset and the BLUETOOTH smartphone or mobile phone.

Note

- If you have previously connected this BLUETOOTH device, an HFP or HSP connection is made automatically when you turn on the headset. At the same time, an A2DP connection may also be made automatically. If this happens, disconnect the headset from the smartphone or mobile phone once using the phone, then connect the devices again by repeating the process from step 1.



To call during playback

1. Operate the  button during playback. [\[Details\]](#) Or, operate the smartphone or mobile phone.

If no dial tone is heard via the headset, switch the call device to the headset using your smartphone or mobile phone. With an HFP connection, you can do this by pressing the  button on the headset for about 2 seconds.

To receive a call

When an incoming call arrives, the music playback pauses, and a ring tone is heard via the headset.

1. Press the  button on the headset and talk using the microphone.
To end a call, press the  button on the headset to switch back to music playback.

Note

- When no ring tone is heard even if an incoming call arrives, stop music playback. When ringing, press the  button and talk.

To disconnect the call

1. Press the  button on the headset to switch back to music playback.
-

Related topic

[Pairing and connecting with a BLUETOOTH device](#)



What can I do to solve a problem?

If the headset does not function as expected, try the following steps to resolve the issue.

1. Find the symptoms of the issue in this manual, and try any corrective actions listed. [\[Details\]](#)
2. Connect the headset to your computer to charge the battery. [\[Details\]](#)
You may be able to resolve some issues by charging the battery.
3. Press the RESET button of the headset.
4. Initialize the headset.
This operation resets volume setting, etc. and deletes all pairing information.
5. Look up information on the issue on the customer support Web site.
<http://www.sony.net/>
6. If the approaches listed above fail to resolve the issue, consult your nearest Sony dealer.

Initializing the headset

1. If the headset is turned on, press and hold the POWER button for about 2 seconds to turn off the headset.
2. Press and hold the POWER button and the  button together for about 7 seconds.
The indicator (blue) flashes 4 times, and the headset is reset to the default setting. All pairing information is deleted.



Table of contents for symptoms and possible causes

The following topics show possible causes and remedies for symptoms. See an appropriate topic according to your problem.

- [Power and charging](#)
 - [BLUETOOTH connection](#)
 - [One touch connection \(NFC\)](#)
 - [Music](#)
 - [Phone calls](#)
-



Power and charging

- The headset is not turned on.
 - Charge the battery of the headset.
 - The headset cannot be turned on while charging the battery. Remove the micro-USB cable from the headset, and then turn on the headset again.
 - The headset cannot be turned on if a connecting cord is connected to the INPUT jack. Remove the connecting cord from the headset, then turn on the headset again.
- Charging cannot be done.
 - Check that the micro-USB cable is connected to the headset and the computer firmly.
 - Check that the computer is turned on.
 - Check that the computer is not in standby, sleep or hibernation mode.
- Charging time is too long.
 - Check that the headset and the computer are directly connected, not via a USB hub.
- The headset cannot be recognized by a computer.
 - The micro-USB cable is not connected properly to the USB port of the computer. Connect the micro-USB cable again.
 - Check that the headset and the computer are directly connected, not via a USB hub.
 - A problem may have occurred with the connected USB port of the computer. Connect to another USB port if it is available.
 - Try the USB connection procedure again in cases other than those stated

above.

Copyright 2012 Sony Corporation



BLUETOOTH connection

- Pairing cannot be done.
 - Bring the headset and the BLUETOOTH device closer together.
- Cannot make a BLUETOOTH connection.
 - Check that the headset is turned on.
 - Check that the BLUETOOTH device is turned on and the BLUETOOTH function is on.
 - Connection with the BLUETOOTH device may not be memorized on the headset. Make a BLUETOOTH connection from the BLUETOOTH device to the headset soon after pairing is complete.
 - The headset or the BLUETOOTH device is in sleep mode.
 - The BLUETOOTH connection is terminated. Make the BLUETOOTH connection again.
- Distorted sound
 - Make sure that the headset is not receiving interference from a wireless LAN, other 2.4 GHz wireless device, or microwave oven.
- The correspondence distance is short. (Sound skips.)
 - If a device that generates electromagnetic radiation, such as a wireless LAN, other BLUETOOTH device(s), or a microwave oven is nearby, move the headset away from such sources.
 - Point the antenna of the headset towards the BLUETOOTH device. Make sure no obstacles blocks the communication.
- The headset does not operate properly.
 - Reset the headset. Pairing information is not deleted by this operation.

Insert a small pin, etc., into the hole, and push it until you feel a click.

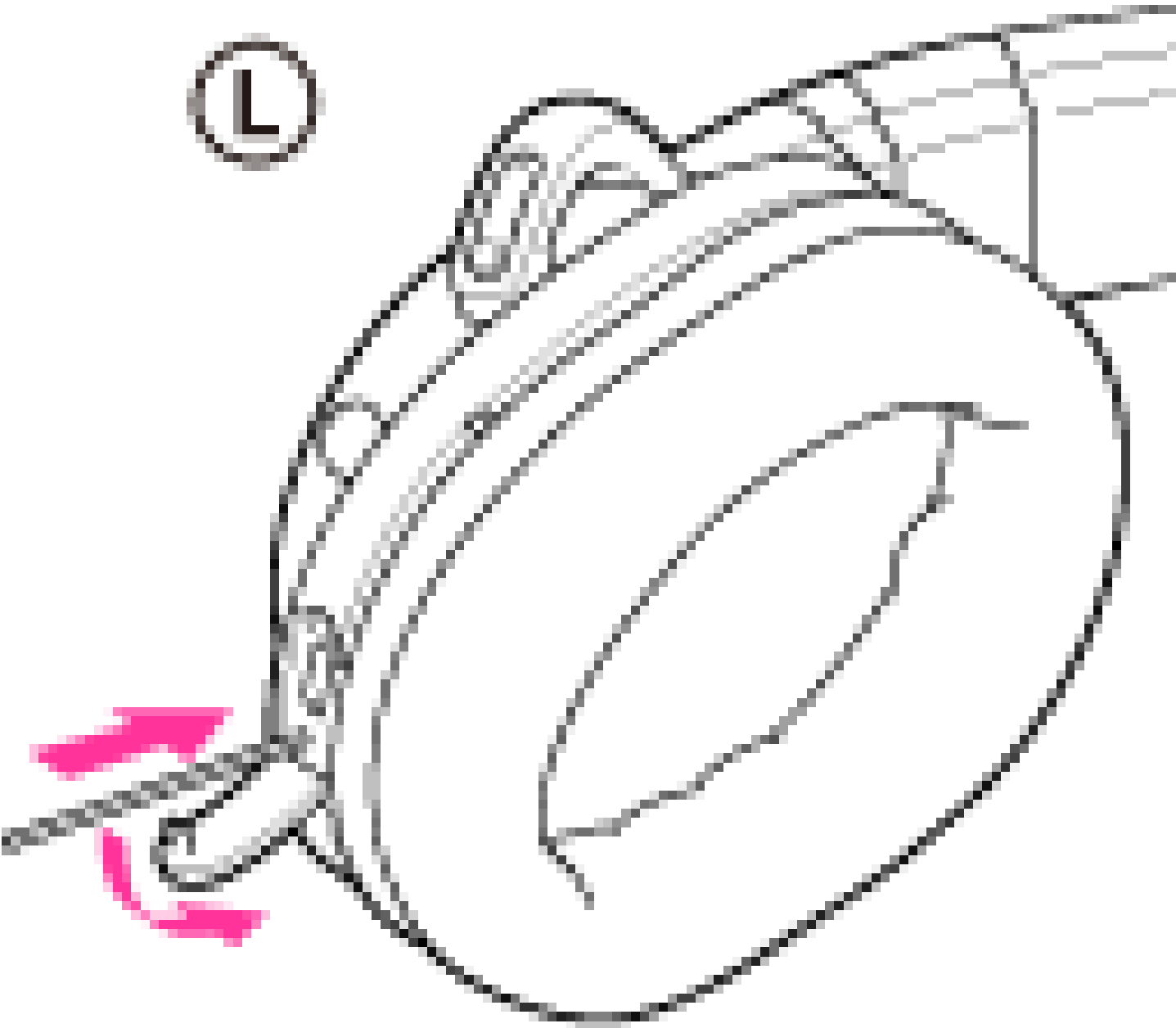

Copyright 2012 Sony Corporation



One touch connection (NFC)

- Cannot make the one touch connection.
 - If the smartphone is in a case, the headset may not react to the touching. Remove the smartphone from the case.
 - If the smartphone does not vibrate, start the app on the smartphone, and move the designated location of the smartphone close to the N mark on the headset.
 - Depending on the smartphone or mobile phone you are using, the NFC sensitivity may not be strong enough to connect the headset with just one touch. In this case, follow the procedure described in “Pairing and connecting with a BLUETOOTH device.” [\[Details\]](#)
 - You cannot make a one touch connection while charging the battery because the headset cannot be turned on. Finish charging first, and then make the one touch connection.
 - If a connecting cord is connected to the INPUT jack, you cannot make a one touch connection because the headset cannot be turned on. Remove the connecting cord first, and then make the one touch connection.
-



Music

- No sound
 - Check that both the headset and the BLUETOOTH device are turned on.
 - An A2DP BLUETOOTH connection is not made between the headset and the BLUETOOTH device. Make an A2DP BLUETOOTH connection.
 - Check that music is being played back by the BLUETOOTH device.
 - Check that the volume of the headset is not set too low.
 - Turn up the volume on the connected device if necessary.
 - Pair the headset and the BLUETOOTH device again.
- Low sound level
 - Turn up the volume of the headset.
 - Turn up the volume on the connected device if necessary.
- Low sound quality
 - Switch the BLUETOOTH connection to A2DP (Advanced Audio Distribution Profile) when HFP (Hands-free Profile) or HSP (Headset Profile) is set.
 - If you have previously connected this BLUETOOTH device, only an HFP/HSP BLUETOOTH connection may be made when the headset is turned on. If this happens, select an A2DP BLUETOOTH connection.
- Sound skips frequently during playback.
 - Reception condition of the headset may have become unstable due to improper matching of the bit rate setting for the music transmitted from the BLUETOOTH device and the environment in which the headset is used.*
Turn off the headset once, then turn it on again by pressing the POWER button for about 2 seconds while pressing the VOL– button to lower the setting

of the bit rate.**

- * Bit rate is a numerical value which represents data transmission volume per second. The higher the bit rate, in general, the better quality the sound will be. The headset can receive high bit rate music but sound skipping may occur depending on the usage environment.
 - ** The above operations may not reduce the sound skip depending on the usage environment. To reset to the original setting, turn off the headset once, then turn it on again by pressing the POWER button for about 2 seconds while pressing the VOL+ button.
-

Copyright 2012 Sony Corporation



Phone calls

- The caller's voice cannot be heard.
 - Check that both the headset and the BLUETOOTH smartphone or mobile phone are turned on.
 - Check the connection between the headset and the BLUETOOTH smartphone or mobile phone. Make a BLUETOOTH connection (HFP or HSP) again.
 - Check that output of the BLUETOOTH smartphone or mobile phone is set for the headset.
 - Check that the volume of the headset is not set too low.
 - Turn up the volume on the BLUETOOTH smartphone or mobile phone if necessary.
 - If you are listening to music using the headset, stop playback, press the  button and talk.
 - Low sound from the caller
 - Turn up the volume of the headset.
 - Turn up the volume on the BLUETOOTH smartphone or mobile phone if necessary.
-



License and trademark notice

- The BLUETOOTH word mark and logos are owned by the Bluetooth SIG, Inc. and any use of such marks by Sony Corporation is under license.
 - The N Mark is a trademark or registered trademark of NFC Forum, Inc. in the United States and in other countries.
 - Android is a trademark of Google Inc.
 - Microsoft, Windows and Windows Vista are registered trademarks or trademarks of Microsoft Corporation in the United States and/or other countries.
 - Macintosh and Mac OS are trademarks of Apple Inc., registered in the U.S. and other countries.
 - Other trademarks and trade names are those of their respective owners.
-