

# Mini Hi-Fi Component System

---

## Operating Instructions

## Owner's Record

The model and serial numbers are located on the rear panel of the unit. Record the serial number in the space provided below. Refer to them whenever you call upon your Sony dealer regarding this product.

Model No. \_\_\_\_\_ Serial No. \_\_\_\_\_



**MHC-GX40/GX30/GX20**  
**MHC-RG33/RG22**

## WARNING

### To prevent fire or shock hazard, do not expose the unit to rain or moisture.

To prevent fire, do not cover the ventilation of the apparatus with news papers, table-cloths, curtains, etc. And don't place lighted candles on the apparatus.

To prevent fire or shock hazard, do not place objects filled with liquids, such as vases, on the apparatus.

Do not install the appliance in a confined space, such as a bookcase or built-in cabinet.

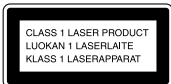

This appliance is classified as a CLASS 1 LASER product. This label is located on the rear exterior.

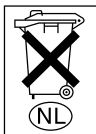

Don't throw away the battery with general house waste, dispose of it correctly as chemical waste.

### NOTICE FOR THE CUSTOMERS IN THE U.S.A.



This symbol is intended to alert the user to the presence of uninsulated "dangerous voltage" within the product's enclosure that may be of sufficient magnitude to constitute a risk of electric shock to persons.



This symbol is intended to alert the user to the presence of important operating and maintenance (servicing) instructions in the literature accompanying the appliance.

### CAUTION

The use of optical instruments with this product will increase eye hazard.

## WARNING

This equipment has been tested and found to comply with the limits for a Class B digital device, pursuant to Part 15 of the FCC Rules. These limits are designed to provide reasonable protection against harmful interference in a residential installation. This equipment generates, uses, and can radiate radio frequency energy and, if not installed and used in accordance with the instructions, may cause harmful interference to radio communications. However, there is no guarantee that interference will not occur in a particular installation. If this equipment does cause harmful interference to radio or television reception, which can be determined by turning the equipment off and on, the user is encouraged to try to correct the interference by one or more of the following measures:

- Reorient or relocate the receiving antenna.
- Increase the separation between the equipment and receiver.
- Connect the equipment into an outlet on a circuit different from that to which the receiver is connected.
- Consult the dealer or an experienced radio/TV technician for help.

## CAUTION

You are cautioned that any changes or modifications not expressly approved in this manual could void your authority to operate this equipment.

### Note to CATV system installer:

This reminder is provided to call the CATV system installer's attention to Article 820-40 of the NEC that provides guidelines for proper grounding and, in particular, specifies that the cable ground shall be connected to the grounding system of the building, as close to the point of cable entry as practical.

### NOTICE FOR THE CUSTOMERS IN CANADA

## CAUTION

TO PREVENT ELECTRIC SHOCK, DO NOT USE THIS POLARIZED AC PLUG WITH AN EXTENSION CORD, RECEPTACLE OR OTHER OUTLET UNLESS THE BLADES CAN BE FULLY INSERTED TO PREVENT BLADE EXPOSURE.

Except for European models



ENERGY STAR® is a U.S. registered mark.

As an ENERGY STAR® Partner, Sony Corporation has determined that this product meets the ENERGY STAR® guidelines for energy efficiency.

# Table of Contents

## List of Button Locations and Reference Pages

Main unit .....	4
Sub woofer .....	5
Remote Control .....	6

## Getting Started

Hooking up the system .....	7
Inserting two R6 (size AA) batteries into the remote .....	9
Setting the clock .....	10

## CD

Loading a CD .....	10
Playing a CD — Normal Play/ Shuffle Play/Repeat Play .....	11
Programing CD tracks — Program Play .....	12

## Tuner

Presetting radio stations .....	13
Listening to the radio — Preset Tuning/ Manual Tuning .....	15
Using the Radio Data System (RDS)* .....	16

## Tape

Loading a tape .....	16
Playing a tape .....	17
Recording to a tape — CD Synchro Recording/Recording Manually ....	18
Timer-recording radio programs .....	19

## Sound Adjustment

Using the sub woofer .....	20
Adjusting the sound .....	20
Selecting the sound effect .....	20
Selecting the surround effect .....	20

## Display

Turning off the display — Power Saving Mode .....	21
Using the CD display .....	21

## Other Features

Enhancing video game sound — Game Sync .....	22
Mixing video game sound with other sound source — Game Mixing .....	22
Falling asleep to music — Sleep Timer .....	22
Waking up to music — Daily Timer ...	23

## Optional Components

Hooking up video game machine .....	24
-------------------------------------	----

## Troubleshooting

Problems and remedies .....	25
Messages .....	26

## Additional Information

Precautions .....	27
Specifications .....	28

\* European model only

How to use this page

Use this page to find the location of buttons and other parts of the system that are mentioned in the text.

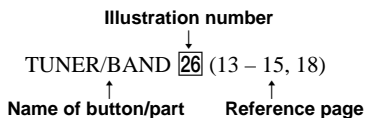

## Main unit

### ALPHABETICAL ORDER

#### A – E

- AUDIO jacks **22** (24)
- CD **27** (11, 12, 18)
- CD SYNC **7** (18)
- Deck A **20** (16, 17)
- Deck B **16** (16 – 19)
- DISC 1 – 3 **10** (11, 12)
- DISC SKIP/EX-CHANGE **11** (10, 11)
- Disc tray **9** (10)
- DISPLAY **2** (16, 21)
- EFFECT ON/OFF **17** (20)

#### G – Z

- GAME **24** (22, 24)
- GAME EQ **19** (20, 24)
- GAME MIXING **4** (22)
- GROOVE **6** (20)
- MOVIE EQ **5** (20)
- MUSIC EQ **3** (20)
- PHONES jack **14**
- REC PAUSE/START **8** (18)
- TAPE A/B **25** (16, 18)
- TUNER/BAND **26** (13 – 15, 18)
- VIDEO jack **23** (24)
- VOLUME control **13**

### BUTTON DESCRIPTIONS

- I/⏻ (power) **1**
- ▲ OPEN/CLOSE **12**
- ▲ (deck B) **15**
- ▶▶ **18**
- ◀◀ **18**
- ▶▶ **18**
- || **18**
- ▶ **18**
- **18**
- ◀ **18**
- ▲ (deck A) **21**

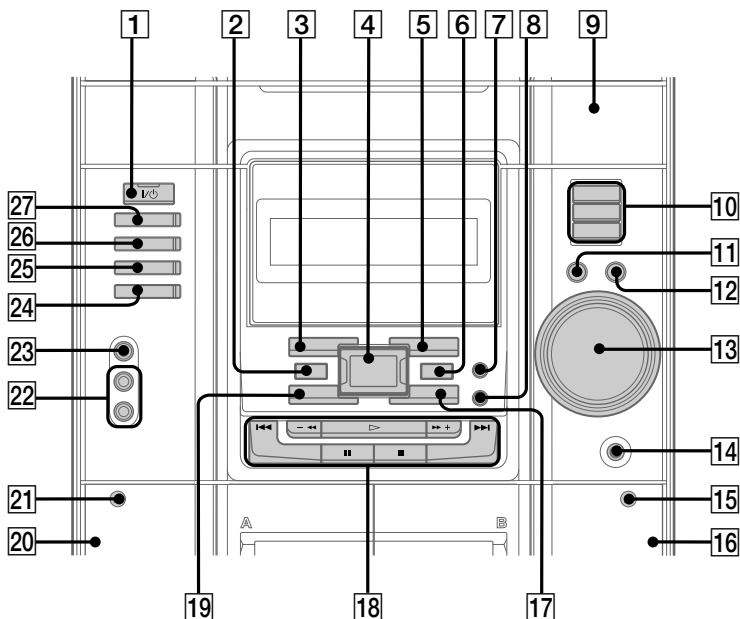

# Sub woofer

(MHC-GX40 only)

ALPHABETICAL ORDER

A - Z

Indicator **1** (20)

ON/OFF **2** (20)

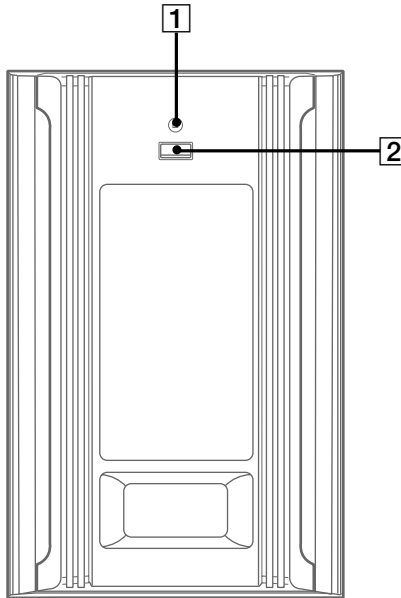

# Remote Control

## ALPHABETICAL ORDER

### A - G

CD **19** (11, 12, 18)  
 CLEAR **20** (12)  
 CLOCK/TIMER SELECT **2**  
 (19, 23)  
 CLOCK/TIMER SET **3** (10, 19,  
 23)  
 DISPLAY **6** (16, 21)  
 D.SKIP **7** (11)  
 ENTER **15** (10, 12 - 14, 19, 23)  
 EQ +/- **14** (20)  
 GAME **10** (22, 24)  
 GROOVE **13** (20)

### O - Z

ON/OFF **16** (20)  
 PLAY MODE **21** (11, 12, 17)  
 PRESET +/- **5** (13 - 15)  
 REPEAT **8** (11)  
 SLEEP **1** (22)  
 STEREO/MONO **8** (15)  
 SURROUND **11** (20)  
 TAPE A/B **9** (16, 18)  
 TUNER MEMORY **17** (13, 14)  
 TUNER/BAND **18** (13 - 15, 18)  
 TUNING +/- **5** (13 - 15)  
 VOL +/- **12**

## BUTTON DESCRIPTIONS

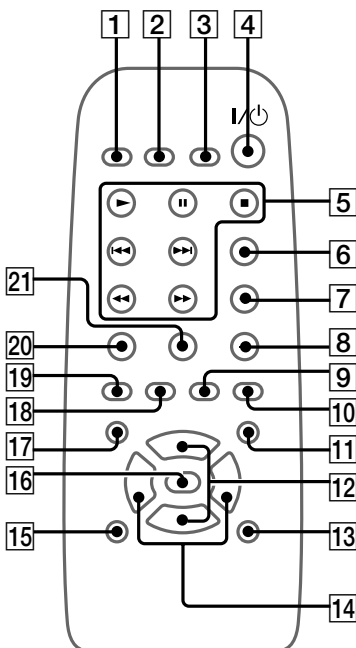
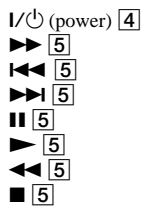

# Hooking up the system

Perform the following procedure **1** to **5** to hook up your system using the supplied cords and accessories.

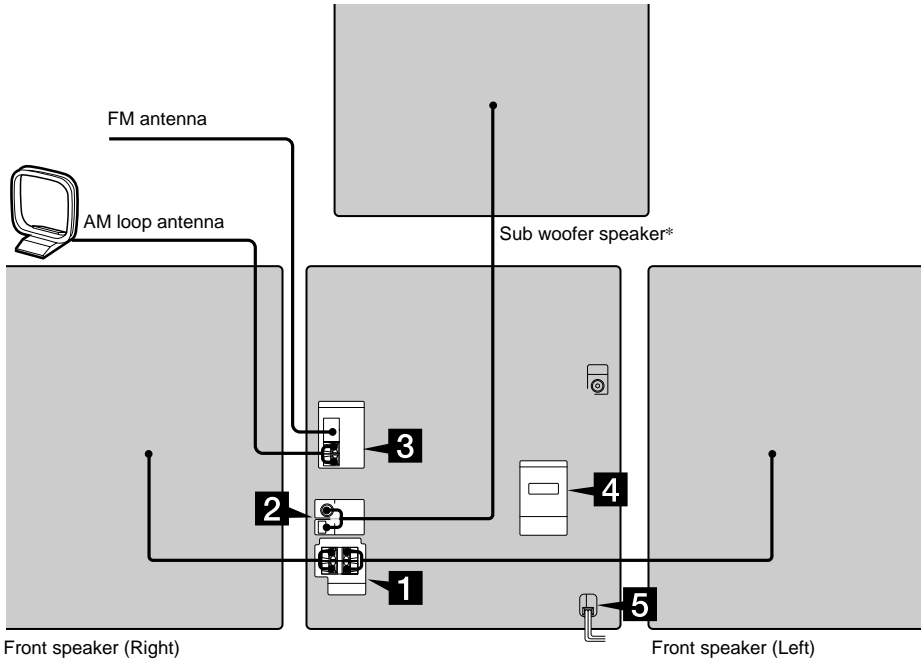

\* MHC-GX40 only

**1** Connect the front speakers.

Connect the speaker cords to the SPEAKER jacks as shown below.

Insert only the stripped portion

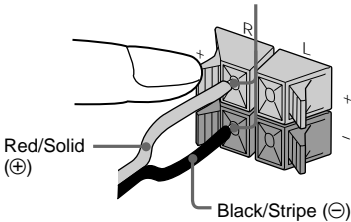

**2** Connect the sub woofer speaker. (MHC-GX40 only)

Connect the speaker cords to the SUB WOOFER OUT jack and SUB WOOFER CONTROL jack as shown below.

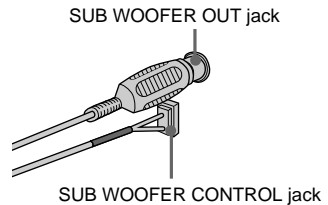

**continued**

## Hooking up the system (continued)

### 3 Connect the FM/AM antennas.

Set up the AM loop antenna, then connect it.

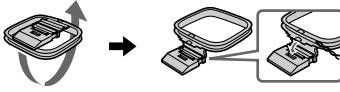

Jack type (A)

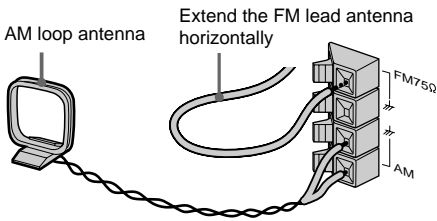

Jack type (B)

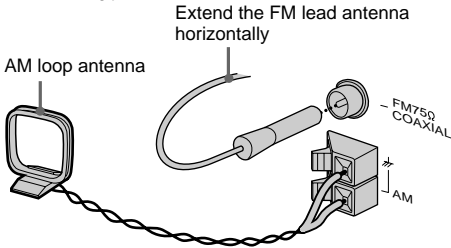

### 4 For models with a voltage selector, set VOLTAGE SELECTOR to the local power line voltage.

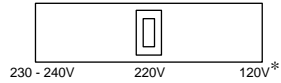

\* Middle Eastern models: 120 – 127 V

### 5 Connect the power cord to a wall outlet.

The demonstration appears in the display. When you press I/⏻, the system turns on and the demonstration automatically ends.

If the supplied adapter on the plug does not fit your wall outlet, detach it from the plug (only for models equipped with an adapter).

To connect optional components  
See page 24.

To attach the front speaker pads  
Attach the supplied front speaker pads to the bottom of the speakers to stabilize the speakers and prevent them from slipping.

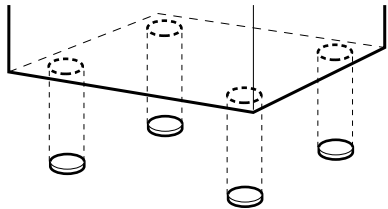

#### Note

Keep the speaker cords away from the antennas to prevent noise.



Placing the sub woofer (MHC-GX40 only)

Since the human ear cannot detect the direction and position where the bass sound being reproduced by a woofer (below 150 Hz) comes from, you can place the woofer wherever you like in your room. To obtain a better bass reproduction, we recommend you to place the woofer on a solid floor where the resonance is unlikely to occur.

#### Notes

- Always place the woofer vertically, keeping a few centimeters from away the wall.
- If the woofer is placed in the center of a room, the bass could be extremely weakened. This is due to the influence of the standing wave of the room. If this happened, move the woofer away from the center of a room or eliminate the cause of the standing wave, by placing a bookshelf on the wall, etc.

#### When carrying this system

Perform the following procedure to protect the CD mechanism.

- 1** Make sure that all discs are removed from the system.
- 2** Press **I/⏻** to turn off the system.
- 3** Unplug the power cord.

## Inserting two R6 (size AA) batteries into the remote

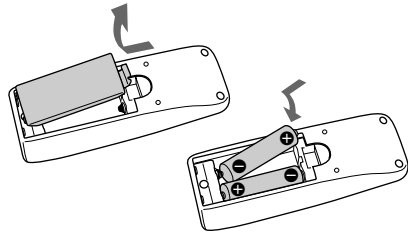

#### Tip

With normal use, the batteries should last for about six months. When the remote no longer operates the system, replace both batteries with new ones.

#### Note

If you do not use the remote for a long period of time, remove the batteries to avoid possible damage from battery leakage.

## Setting the clock

- 1 Press I/⏻ to turn on the system.
- 2 Press CLOCK/TIMER SET on the remote.
- 3 Press ◀◀ or ▶▶ on the remote repeatedly to set the hour.
- 4 Press ENTER on the remote.  
The minute indication flashes.
- 5 Press ◀◀ or ▶▶ on the remote repeatedly to set the minute.
- 6 Press ENTER on the remote.  
The clock starts working.

To adjust the clock

- 1 Press CLOCK/TIMER SET on the remote.
- 2 Press ◀◀ or ▶▶ on the remote to select "CLOCK SET", then press ENTER on the remote.
- 3 Do the same procedures as step 3 to 6 above.

Note

The clock settings are canceled when you disconnect the power cord or if a power failure occurs.

## Loading a CD

- 1 Press ▲ OPEN/CLOSE.  
The disc tray opens.
- 2 Place a CD with the label side up on the disc tray.

When you play a CD single (8 cm CD), place it on the inner circle of the tray.

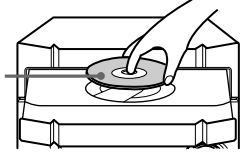

To insert additional discs, press DISC SKIP/EX-CHANGE to rotate the disc tray.

- 3 Press ▲ OPEN/CLOSE to close the disc tray.

## Playing a CD

### — Normal Play/Shuffle Play/Repeat Play

This system lets you play the CD in different play modes.

Disc tray number

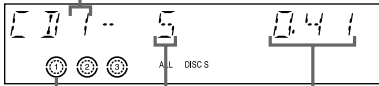

Disc presence indicator

Track number

Playing time

### 1 Press CD.

### 2 Press PLAY MODE on the remote repeatedly until the mode you want appears in the display.

Select	To play
ALL DISCS (Normal Play)	All CDs in the disc tray continuously.
1DISC (Normal Play)	The CD you have selected in original order.
ALL DISCS SHUF (Shuffle Play)	The tracks on all CDs in random order.
1DISC SHUF (Shuffle Play)	The tracks on the CD you have selected in random order.
PGM (Program Play)	The tracks on all CDs in the order you want them to be played (see "Programing CD tracks" on page 12).

### 3 Press ▷ (or ► on the remote).

## Other Operations

To	Do this
Stop play	Press ■.
Pause	Press ■■. Press again to resume play.
Select a track	During play or pause, press ►► or ◀◀.
Find a point in a track	During play, press and hold ►► or ◀◀. Release it when you find the desired point.
Select a CD in stop mode	Press DISC 1 – 3 or DISC SKIP/EX-CHANGE (or D.SKIP on the remote).
Switch to CD function from another source	Press DISC 1 – 3 (Automatic Source Selection).
Remove a CD	Press ▲ OPEN/CLOSE.
Exchange other CDs while playing	Press DISC SKIP/EX-CHANGE.
Play repeatedly (Repeat Play)	Press REPEAT on the remote during play until "REP" or "REP 1" appears. REP*: For all the tracks on the CD up to five times. REP 1**: For a single track only. To cancel playing repeatedly, press REPEAT until "REP" or "REP 1" disappears.

\* You cannot select "REP" and "ALL DISCS SHUF" at the same time.

\*\* When you select "REP 1", that track is repeated endlessly until "REP 1" is canceled.

#### Note

The play mode cannot be changed while playing a disc. To change the play mode, press ■ first to stop playing.

## Programming CD tracks

### — Program Play

You can make a program of up to 25 tracks from all the CDs in the order you want to play them.

- 1 Press **CD**.
- 2 Press **PLAY MODE** on the remote repeatedly until “**PGM**” appears in the display.
- 3 Press one of **DISC 1 – 3** to select a CD.  
To program all the tracks on a CD at once, proceed to step 5 with “**AL**” displayed.
- 4 Press **◀** or **▶** until the desired track appears in the display.

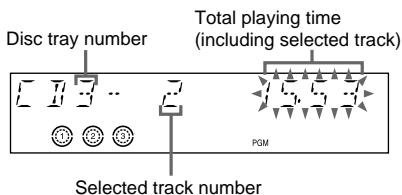

- 5 Press **ENTER** on the remote.  
The track is programmed. The program step number appears, followed by the total playing time.

### 6 Program additional discs or tracks.

To program	Repeat steps
Other discs	3 and 5
Other tracks on the same disc	4 and 5
Other tracks on other discs	3 to 5

- 7 Press **▷** (or **▶** on the remote).

### Other Operations

To	Do this
Cancel Program Play	Press <b>PLAY MODE</b> on the remote repeatedly until “ <b>PGM</b> ” and “ <b>SHUF</b> ” disappear.
Clear a track from the end	Press <b>CLEAR</b> on the remote in stop mode.

#### Tips

- The program you made remains after Program Play finishes. To play the same program again, press **CD**, then press **▷** (or **▶** on the remote).
- “--” appears when the total CD program time exceeds 100 minutes, or when you select a CD track whose number is 21 or over.

## Presetting radio stations

You can preset up to 20 FM stations and 10 AM stations. You can then tune in any of those stations simply by selecting the corresponding preset number.

There are two ways to store the station presets.

To	Method
Automatically preset all of the stations that can be received in your area	Automatic Tuning Preset
Manually set the radio frequency of your favourite stations	Manual Tuning Preset

## Setting presets through automatic tuning

- 1 Press **TUNER/BAND** repeatedly to select "FM" or "AM".
- 2 Press and hold **◀◀** or **▶▶** (or **TUNING -** or **+** on the remote) until the frequency indication starts to change, then release it.

Scanning stops automatically when the system tunes in a station. "TUNED" and "STEREO" (for an FM stereo program) appear.



### If "TUNED" does not appear and the scanning does not stop

Set the frequency of the desired radio station as described in steps 2 through 6 of "Setting presets through manual tuning".

- 3 Press **TUNER MEMORY** on the remote. A preset number appears in the display. The stations are stored from preset number 1.

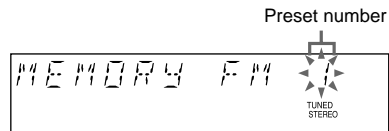

- 4 Press **◀◀** or **▶▶** (or **PRESET -** or **+** on the remote) repeatedly to select the desired preset number.
- 5 Press **ENTER** on the remote.
- 6 Repeat steps 1 to 5 to store other stations.

continued

### Setting presets through manual tuning

- 1 Press TUNER/BAND repeatedly to select “FM” or “AM”.**
- 2 Press ◀◀ or ▶▶ (or TUNING – or + on the remote) repeatedly to tune in the desired station.**
- 3 Press TUNER MEMORY on the remote.**  
A preset number appears in the display.  
The stations are stored from preset number 1.
- 4 Press ◀◀ or ▶▶ (or PRESET – or + on the remote) repeatedly to select the desired preset number.**
- 5 Press ENTER on the remote.**
- 6 Repeat steps 1 to 5 to store other stations.**

To	Do this
Tune in a station with a weak signal	Follow the procedure described in “Setting presets through manual tuning”.
Set another station to an existing preset number	Start over from step 1. After step 3, press ◀◀ or ▶▶ (or PRESET – or + on the remote) repeatedly to select the preset number you want to store the other station.

To change the AM tuning interval (except for the European and Middle Eastern models)

The AM tuning interval is factory-set to 9 kHz (10 kHz in some areas). To change the AM tuning interval, tune in any AM station first, then turn off the system. While holding down TUNER/BAND, turn the system back on. When you change the interval, all the AM preset stations are erased. To reset the interval, repeat the same procedure.

#### Note

You cannot change the AM tuning interval in the Power Saving Mode.

#### Tips

- The preset stations are retained for half a day even if you disconnect the mains lead or if a power failure occurs.
- To improve broadcast reception, reorient or move the supplied antenna near a window or outdoors.

## Listening to the radio

You can listen to a radio station either by selecting a preset station, or by manually tuning in the station.

### Listening to a preset station

#### — Preset Tuning

Preset radio stations in the tuner's memory first (see "Presetting radio stations" on page 13).

- 1 Press **TUNER/BAND** repeatedly to select "FM" or "AM".
- 2 Press **◀◀** or **▶▶** (or **PRESET –** or **+** on the remote) repeatedly to select the desired preset station.

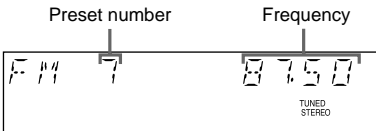

### Listening to non-preset radio station

#### — Manual Tuning

- 1 Press **TUNER/BAND** repeatedly to select "FM" or "AM".
- 2 Press **◀◀** or **▶▶** (or **TUNING –** or **+** on the remote) repeatedly to tune in the desired station.

#### Tips

- To improve broadcast reception, adjust the supplied antennas.
- When an FM stereo program has static noise, press **STEREO/MONO** on the remote repeatedly until "MONO" appears. There will be no stereo effect, but the reception will improve.
- Press and hold **◀◀** or **▶▶** (or **TUNING –** or **+** on the remote). The frequency indication changes and scanning stops when the system tunes in a station (Automatic Tuning).
- To record from the radio, see "Recording to a tape" on page 18 or "Timer-recording radio programs" on page 19.

## Using the Radio Data System (RDS)

(MHC-RG33/RG22, European model only)

What is the Radio Data System?

Radio Data System (RDS) is a broadcasting service that allows radio stations to send additional information along with the regular program signal. This tuner offers convenient RDS features like station name display and location of stations by program type. RDS is available only on FM stations.\*

Note

RDS may not work properly if the station you tuned in is not transmitting the RDS signal properly or if the signal is weak.

\* Not all FM stations provide RDS service, nor do they provide the same types of services. If you are not familiar with the RDS system, check with your local radio stations for details on RDS services in your area.

### Receiving RDS broadcasts

Simply select a station from the FM band. When you tune in a station that provides RDS services, the station name appears in the display.

To check the RDS information

Each time you press DISPLAY, the display changes cyclically as follows:

Station name\* → Frequency → Program type\* → Clock display → Effect status

\* If the RDS broadcast is not received, the station name and program type may not appear in the display.

## Loading a tape

- 1 Press **TAPE A/B** repeatedly to select deck A or B.
- 2 Press **▲**.
- 3 Insert a tape in deck A or B with the **side you want to play/record facing forward**.

With the side you want to play/record facing forward.

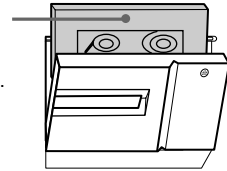



# Playing a tape

You can use TYPE I (normal) tape.

## 1 Load a tape.

To play both decks in succession, press **PLAY MODE** on the remote repeatedly until “RELAY” (Relay Play)\* appears in the display.

## 2 Press ▷ (or ► on the remote).

The tape starts playing.



\* After the playback of the front side of deck A, deck B plays the front side, then stops.

## Other Operations

To	Do this
Stop play	Press ■.
Pause	Press ■■. Press again to resume play.
Fast-forward or rewind	Press ◀◀ or ▶▶.
Remove the cassette	Press ▲.

Searching for the beginning of the current or the next track (AMS)\*

To go forward

Press ▶▶ during playback.

“TAPE A (or TAPE B) >>> +1” appears.

To go back

Press ◀◀ during playback.

“TAPE A (or TAPE B) <<< -1” appears.

\* AMS (Automatic Music Sensor)

Note

The AMS function may not operate correctly under the following circumstances:

- When the unrecorded space between songs is less than 4 seconds long.
- When the system is placed near a television.

## Recording to a tape

### — CD Synchro Recording/Recording Manually

You can record from a CD, tape (or connected components) or radio. You can use TYPE I (normal) tapes. The recording level is adjusted automatically.

Steps	Recording from a CD (CD Synchro Recording)	Recording from a CD/tape/radio manually
1	Load a recordable tape into deck B.	
2	Press <b>CD</b> .	Press <b>CD, TAPE A/B</b> or <b>TUNER/BAND</b> .
3	Load the CD you want to record.	Load the CD or tape (or other music source), or tune in the station you want to record.
4	Press <b>CD SYNC</b> .	Press <b>REC PAUSE/START</b> .
	Deck B stands by for recording. “REC” flashes.	
5	Press <b>REC PAUSE/START</b> . Recording starts.	Press <b>REC PAUSE/START</b> , and then start playing the desired source to record.

To stop recording

Press **■**.

Tip

For recording from the radio:

If noise is heard while recording from the radio, move the respective antenna to reduce the noise.

Note

You cannot listen to other sources while recording.

## Timer-recording radio programs

You can record a preset radio station from a specified time.

To timer-record, you must first preset the radio station (see “Presetting radio stations” on page 13) and set the clock (see “Setting the clock” on page 10).

### 1 Tune in the preset radio station (see “Listening to the radio” on page 15).

### 2 Press CLOCK/TIMER SET on the remote.

“DAILY SET” appears.

### 3 Press ◀◀ or ▶▶ on the remote repeatedly to select “REC SET”, then press ENTER on the remote.

“ON” appears and the hour indication flashes in the display.

### 4 Set the time to start recording.

Press ◀◀ or ▶▶ on the remote repeatedly to set the hour, then press ENTER on the remote.

The minute indication starts flashing.

Press ◀◀ or ▶▶ on the remote repeatedly to set the minute, then press ENTER on the remote.

### 5 Repeat step 4 to set the time to stop recording.

The start time appears, followed by the stop time, the preset radio station to be recorded (e.g., “TUNER FM 5”), then the original display appears.

### 6 Load a recordable tape into deck B.

### 7 Press I/⏻ to turn off the system.

When the recording starts, the volume level is set to minimum.

## Other Operations

To	Do this
Check the setting	Press CLOCK/TIMER SELECT on the remote and press ◀◀ or ▶▶ on the remote repeatedly to select “REC SELECT”, then press ENTER on the remote.
Change the setting	Start over from step 1.
Cancel the timer	Press CLOCK/TIMER SELECT on the remote and press ◀◀ or ▶▶ on the remote repeatedly to select “TIMER OFF”, then press ENTER on the remote.

### Notes

- If the system is on at the preset time, the recording will not be made.
- When you use the Sleep Timer, Timer-recording and Daily Timer will not turn on the system until the Sleep Timer turns it off.
- You cannot activate the Daily Timer and Timer-recording at the same time.

### Using the sub woofer

(MHC-GX40 only)

You can use the sound of the sub woofer to suit the sound source.

#### Press ON/OFF on the sub woofer.

The indicator lights up while the sub woofer turns on.

Press the button again to turn off the sub woofer.

#### Tip

You can use VOLUME (VOL – or + on the remote) to adjust the volume of the sub woofer linked to the front speakers.

### Adjusting the sound

You can reinforce the bass and create a more powerful sound.

#### Press GROOVE.

“GROOVE” appears in the display and the volume switches to power mode.

Press the button again to cancel GROOVE.

### Selecting the sound effect

Selecting the effect from the music menu

**Press MUSIC EQ, MOVIE EQ or GAME EQ (or EQ – or + on the remote\*) repeatedly to select the preset you desire.**

The preset name appears in the display. See the chart “Sound effect options”.

\* You can select all of the effects in order.

To cancel the effect

Press EFFECT ON/OFF (or ON/OFF on the remote).

Sound effect options

“SURR” appears if you select an effect with surround effects.

#### MUSIC EQ

---

##### Effect

---

ROCK	Standard music sources
POP	

---

#### MOVIE EQ

---

##### Effect

---

MOVIE	Soundtracks and special listening situations
-------	--

---

#### GAME EQ

---

##### Effect

---

GAME	PlayStation 1, 2 and other video game music sources
------	---

---

### Selecting the surround effect

**Press SURROUND on the remote.**

“SURR” appears in the display.

Press the button again to cancel SURROUND.

## Turning off the display

### — Power Saving Mode

Even if the system is off, the system consumes power to display the clock and to stay responsive to commands from the remote.

Power saving mode reduces the amount of power consumed during standby.

In this mode, the clock is not displayed.

**Press DISPLAY repeatedly while the system is off until the demonstration display or the clock display disappears.**

To cancel the Power Saving Mode

Press DISPLAY while the system is off. Each time you press the button, the display switches cyclically as follows:

Demonstration display → Clock display\* →

No display (Power Saving Mode)

\* The clock is displayed only if you set the clock.

Tip

The timer continues to operate in Power Saving Mode.

## Using the CD display

### Checking the remaining time

**Press DISPLAY repeatedly during play.**

Each time you press the button, the display changes cyclically as follows:

Elapsed playing time on the current track →

Remaining time on the current track →

Remaining time on the current CD → Clock

display (for eight seconds) → Effect status

### Checking the total playing time

**Press DISPLAY repeatedly in stop mode.**

Each time you press the button, the display changes cyclically as follows:

During normal play mode:

Total number of tracks and total playing time

→ Clock display (for eight seconds) → Effect status

During Program Play mode when there is a program:

The last track number of the program and the

total playing time → Total number of

programed tracks (for five seconds) → Clock

display (for eight seconds) → Effect status

## Enhancing video game sound

### — Game Sync

You need to connect a video game machine (see “Hooking up video game machine” on page 24).

#### Press GAME.

##### Tips

- In the standby mode, the system automatically turns on.
- The GAME EQ is automatically selected.
- These operations cannot be performed in the Power Saving Mode.

## Mixing video game sound with other sound source

### — Game Mixing

#### 1 Select the desired source sound.

#### 2 Press GAME MIXING.

Each time you press the button, the level of the game sound changes cyclically as follows:

MIXING LOW → MIXING MID →  
MIXING HIGH → MIXING OFF

##### Tips

- The GAME MIXING indicator lights up while Game Mixing is activated.
- Once Game Mixing is activated, it will remain active while the power is on even if the source sound is changed.

##### Note

If you start recording while Game Mixing is activated, Game Mixing is canceled. To record the mixed sound, press GAME MIXING after step 4 of “Recording from a CD/tape/radio manually” on page 18, and then press REC PAUSE/START to start the recording.

## Falling asleep to music

### — Sleep Timer

You can set the system to turn off after a certain time, so that you can fall asleep to music.

#### Press SLEEP on the remote.

Each time you press the button, the minute display (the turn-off time) changes cyclically as follows:

AUTO\* → 90 MIN → 80 MIN → 70 MIN  
→ ... → 10 MIN → OFF

- \* The system turns off when the current CD or tape finishes playback (for up to 100 minutes).

## Other Operations

To	Press
Check the remaining time**	SLEEP on the remote once.
Change the time to turn off	SLEEP on the remote repeatedly to select the time you want.
Cancel the Sleep Timer function	SLEEP on the remote repeatedly until “SLEEP OFF” appears.

\*\* You cannot check the remaining time when you select “AUTO”.

# Waking up to music

## — Daily Timer

You can wake up to music at a preset time. Make sure you have set the clock (see “Setting the clock” on page 10).

### 1 Prepare the music source you want to play.

- CD: Load a CD. To start from a specific track, make a program (see “Programming CD tracks” on page 12).
- Tape: Load a tape with the side you want to play facing forward.
- Radio: Tune in the preset station you want (see “Listening to the radio” on page 15).

### 2 Adjust the volume.

### 3 Press CLOCK/TIMER SET on the remote.

“DAILY SET” appears.

### 4 Press ENTER on the remote.

“ON” appears and the hour indication flashes.

### 5 Set the time to start playing.

Press **◀◀** or **▶▶** on the remote repeatedly to set the hour, then press ENTER on the remote.

The minute indication flashes.

Press **◀◀** or **▶▶** on the remote repeatedly to set the minute, then press ENTER on the remote.

### 6 Repeat step 5 to set the time to stop playing.

### 7 Press **◀◀** or **▶▶** on the remote repeatedly until the music source you want appears.

The indication changes as follows:

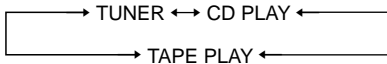

### 8 Press ENTER on the remote.

The type of timer (“DAILY”), followed by the start time, stop time, and the music source appear, then the original display appears.

### 9 Press I/⏻ to turn off the system.

## Other Operations

To	Do this
Check the setting	Press CLOCK/TIMER SELECT on the remote and press <b>◀◀</b> or <b>▶▶</b> on the remote repeatedly to select “DAILY”, then press ENTER on the remote.
Change the setting	Start over from step 1.
Cancel the timer	Press CLOCK/TIMER SELECT on the remote and press <b>◀◀</b> or <b>▶▶</b> on the remote repeatedly to select “TIMER OFF”, then press ENTER on the remote.

#### Tip

The system turns on 15 seconds before the preset time.

#### Notes

- When you use the Sleep Timer, the Daily Timer will not turn on the system until the Sleep Timer turns it off.
- You cannot activate the Daily Timer and Timer-recording at the same time.
- If the system is on at the preset time, you cannot activate the Daily Timer.

## Hooking up video game machine

To enhance your system, you can connect optional components. Refer to the operating instructions provided with each component.

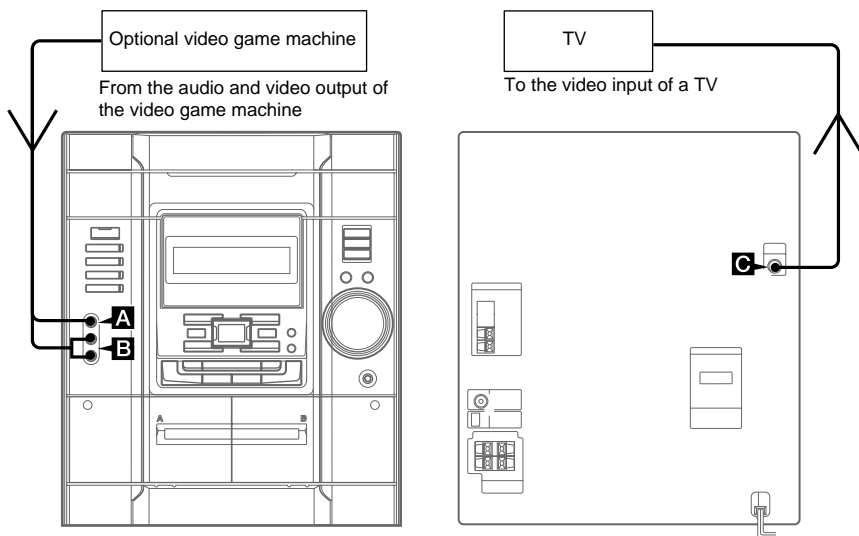

### **A** VIDEO INPUT jack

Use a video cable (not supplied) to connect the video output of the optional video game machine to this jack.

### **B** AUDIO INPUT jacks

Use audio cords (not supplied) to connect the audio output of the optional video game machine to these jacks. You can then output audio through this system.

### **C** VIDEO OUT jack

Use a video cable (not supplied) to connect the video input of TV to this jack.

### Notes

- The video game machine image may appear on the TV screen even if the system is turned off.
- See “Selecting the sound effect” on page 20 for video game sound effects.
- If you press GAME while the system is off, the system turns on, the function switches to GAME, and the equalizer also switches to the GAME EQ.
- If you press GAME while the system is on, the function switches to GAME and the equalizer automatically switches to the GAME EQ in the same manner.



## Problems and remedies

If you have any problem using this system, use the following check list.

First, check that the power cord is connected firmly and the speakers are connected correctly and firmly.

Should any problem persist, consult your nearest Sony dealer.

### General

**The display starts flashing as soon as you plug in the power cord even though you have not turned on the system (see step 5 of "Hooking up the system" on page 8).**

- Press DISPLAY twice while the system is off. The demonstration disappears.

**"-- --" lights in the display.**

- A power interruption occurred. Set the clock and timer settings again.

**The clock setting/radio presetting/timer is canceled.**

- The power cord is disconnected or a power failure occurs longer than half a day. Redo the following:
  - "Setting the clock" on page 10
  - "Presetting radio stations" on page 13

If you have set the timer, also redo "Waking up to music" on page 23 and "Timer-recording radio programs" on page 19.

**There is no sound.**

- Turn VOLUME clockwise.
- The headphones are connected.
- Insert only the stripped portion of the speaker cord into the SPEAKER jack. Inserting the vinyl portion of the speaker cord will obstruct the speaker connections.
- There is no audio output during timer recording.

**There is severe hum or noise.**

- A TV or VCR is placed too close to the system. Move the system away from the TV or VCR.

**The timer does not function.**

- Set the clock correctly.

**"DAILY" and "REC" do not appear when you press CLOCK/TIMER SET.**

- Set the timer correctly.
- Set the clock.

**The remote does not function.**

- There is an obstacle between the remote and the system.
- The remote is not pointing in the direction of the system's sensor.
- The batteries have run down. Replace the batteries.

**There is acoustic feedback.**

- Reduce the volume.

**The color irregularity on a TV screen persists.**

- Turn off the TV set once, then turn it on after 15 to 30 minutes. If the color irregularity still persists, place the speakers farther away from the TV set.

### Speakers

**Sound comes from one channel or unbalanced left and right volume.**

- Check the speaker connection and speaker placement.

**Sound lacks bass.**

- Check that the speaker's + and - jacks are connected correctly.

**continued**

## Problems and remedies (continued)

### CD Player

---

#### The CD tray does not close.

- The CD is not placed properly.
- 

#### The CD will not play.

- The CD is not lying flat in the disc tray.
  - The CD is dirty.
  - The CD is loaded label side down.
  - There is moisture on the CD.
- 

#### Play does not start from the first track.

- The player is in program or shuffle mode. Press PLAY MODE repeatedly until “PGM” or “SHUF” disappears.
- 

#### The disc tray does not open and “LOCKED” appears.

- Contact your Sony dealer or local authorized Sony service facility.
- 

### Tape Deck

---

#### The tape does not record.

- No tape in the cassette holder.
  - The tab has been removed from the cassette (see “To save a tape permanently” on page 27).
  - The tape has reeled to the end.
- 

#### The tape does not record nor play or there is a decrease in sound level.

- The heads are dirty (see “Cleaning the tape heads” on page 28).
  - The record/playback heads are magnetized (see “Demagnetizing the tape heads” on page 28).
- 

#### The tape does not erase completely.

- The record/playback heads are magnetized (see “Demagnetizing the tape heads” on page 28).
- 

#### There is excessive wow or flutter, or the sound drops out.

- The capstans or pinch rollers are dirty (see “Cleaning the tape heads” on page 28).
- 

#### Noise increases or the high frequencies are erased.

- The record/playback heads are magnetized (see “Demagnetizing the tape heads” on page 28).
- 

### Tuner

---

#### There is severe hum or noise (“TUNED” or “STEREO” flashes in the display).

- Adjust the antenna.
  - The signal strength is too weak. Connect the external antenna.
- 

#### A stereo FM program cannot be received in stereo.

- Press STEREO/MONO on the remote repeatedly until “MONO” disappears.
- 

If other troubles not described above occur, reset the system as follows:

**1** Unplug the power cord.

**2** Plug the power cord back in.

**3** Press ■, GROOVE, and I/⏻ at the same time.

**4** Press I/⏻ to turn on the system.

The system is reset to the factory settings. All the settings you made are cleared.

## Messages

One of the following messages may appear or flash in the display during operation.

---

#### NO DISC

- There is no CD on the disc tray.
- 

#### OVER

- You have reached the end of the CD.
- 

#### “PROTECT” and “PUSH POWER” appear alternately.

- A strong signal was input. Press I/⏻ to turn off the system, leave the system turned off for a while, then press I/⏻ again to turn on the system. If “PROTECT” and “PUSH POWER” appear alternately even after the system is turned on again, press I/⏻ to turn off the system and check the speaker cord.
-

## Precautions

### On operating voltage

Before operating the system, check that the operating voltage of your system is identical with the voltage of your local power supply.

### On safety

- The unit is not disconnected from the AC power source (mains) as long as it is connected to the wall outlet, even if the unit itself has been turned off.
- Unplug the system from the wall outlet (mains) if it is not to be used for an extended period of time. To disconnect the cord (mains lead), pull it out by the plug. Never pull the cord itself.
- Should any solid object or liquid fall into the component, unplug the system and have it checked by qualified personnel before operating it any further.
- The AC power cord must be changed only at a qualified service shop.

### On placement

- Do not place the system in an inclined position.
- Do not place the system in locations where it is:
  - Extremely hot or cold
  - Dusty or dirty
  - Very humid
  - Subject to vibrations
  - Subject to direct sunlight.

### On heat build up

- Although the system heats up during operation, this is not a malfunction.
- Place the system in a location with adequate ventilation to prevent heat build up in the system.
- If you continuously use this system at a large volume, the cabinet temperature of the top, side and bottom rises considerably. To avoid burning yourself, do not touch the cabinet.
- To prevent a malfunction, do not cover the ventilation hole for the cooling fan.

### On operation

- If the system is brought directly from a cold to a warm location, or is placed in a very damp room, moisture may condense on the lens inside the CD player. Should this occur, the system will not operate properly. Remove the CD and leave the system turned on for about an hour until the moisture evaporates.
- When you move the system, take out any discs.

If you have any questions or problems concerning your stereo system, please consult your nearest Sony dealer.

### Notes on CDs

- Before playing, clean the CD with a cleaning cloth. Wipe the CD from the center out.
- Do not use solvents.
- Do not expose the CD to direct sunlight or heat sources.

### Note on CD-R/CD-RW playback

Discs recorded on CD-R/CD-RW drives may not be played back because of scratches, dirt, recording condition or the drive's characteristics. Besides, the discs, which are not yet finalized at the end of recording, cannot be played back.

### Cleaning the cabinet

Use a soft cloth slightly moistened with mild detergent solution.

### To save a tape permanently

To prevent a tape from being accidentally recorded over, break off the cassette tab from side A or B as illustrated. If you later want to reuse the tape for recording, cover the broken tab with adhesive tape.

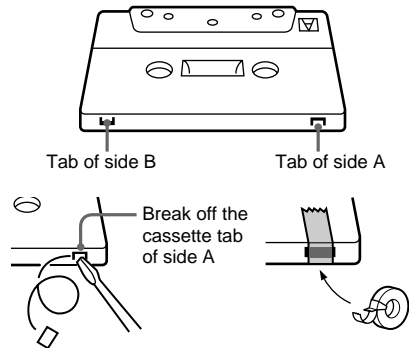

**continued**

## Precautions (continued)

Before placing a cassette in the tape deck

Take up any slack in the tape. Otherwise the tape may get entangled in the parts of the tape deck and become damaged.

When using a tape longer than 90 minutes

The tape is very elastic. Do not change the tape operations such as play, stop, and fast-winding frequently. The tape may get entangled in the tape deck.

### Cleaning the tape heads

Clean the tape heads after every 10 hours of use.

Be sure to clean the tape heads before you start an important recording or after playing an old tape. Use a separately sold dry-type or wet-type cleaning cassette. For details, refer to the instructions of the cleaning cassette.

### Demagnetizing the tape heads

Demagnetize the tape heads and the metal parts that have contact with the tape every 20 to 30 hours of use with a separately sold demagnetizing cassette. For details, refer to the instructions of the demagnetizing cassette.

## Specifications

AUDIO POWER SPECIFICATIONS:  
(MHC-GX40/GX20 USA model only)

POWER OUTPUT AND TOTAL  
HARMONIC DISTORTION:

with 6 ohms loads both channels driven, from 120 – 10,000 Hz; rates 60 watts per channel minimum RMS power, with no more than 10% total harmonic distortion from 250 milliwatts to rated output.

Total harmonic distortion less than 0.07%  
(6 ohms at 1 kHz, 30 W)

### Amplifier section

#### North American models:

##### MHC-GX40

Front speaker

Continuous RMS power output (reference)

60 + 60 watts (6 ohms at  
1 kHz, 10% THD)

Total harmonic distortion less than 0.07%

(6 ohms at 1 kHz, 30 W)

Sub woofer

Continuous RMS power output (reference)

120 watts (12 ohms at  
40 Hz, 10% THD)

Total harmonic distortion less than 0.07%

(12 ohms at 40 Hz, 60 W)

##### MHC-GX30

Continuous RMS power output (reference)

75 + 75 watts (6 ohms at  
1 kHz, 10% THD)

Total harmonic distortion less than 0.07%

(6 ohms at 1 kHz, 40 W)

##### MHC-GX20

Continuous RMS power output (reference)

60 + 60 watts (6 ohms at  
1 kHz, 10% THD)

Total harmonic distortion less than 0.07%

(6 ohms at 1 kHz, 30 W)

## European models:

### MHC-RG33

DIN power output (rated)	60 + 60 watts (6 ohms at 1 kHz, DIN)
Continuous RMS power output (reference)	75 + 75 watts (6 ohms at 1 kHz, 10% THD)
Music power output (reference)	150 + 150 watts (6 ohms at 1 kHz, 10% THD)

### MHC-RG22

DIN power output (rated)	50 + 50 watts (6 ohms at 1 kHz, DIN)
Continuous RMS power output (reference)	60 + 60 watts (6 ohms at 1 kHz, 10% THD)
Music power output (reference)	120 + 120 watts (6 ohms at 1 kHz, 10% THD)

## Other models:

### MHC-RG33

The following measured at AC 120, 220, 240 V,  
50/60 Hz

DIN power output (rated)	60 + 60 watts (6 ohms at 1 kHz, DIN)
Continuous RMS power output (reference)	75 + 75 watts (6 ohms at 1 kHz, 10% THD)

### MHC-RG22

The following measured at AC 120, 127, 220, 240 V  
50/60 Hz

DIN power output (rated)	50 + 50 watts (6 ohms at 1 kHz, DIN)
Continuous RMS power output (reference)	60 + 60 watts (6 ohms at 1 kHz, 10% THD)

## Inputs

AUDIO INPUT (phono jack):  
voltage 450 mV,  
impedance 47 kilohms

## Outputs

PHONES (stereo mini jack):  
accepts headphones of  
8 ohms or more

Front speaker: accepts impedance of 6 to  
16 ohms

Sub woofer speaker (MHC-GX40 only):  
accepts impedance of 12  
to 16 ohms

## CD player section

System	Compact disc and digital audio system
Laser	Semiconductor laser ( $\lambda=780$ nm) Emission duration: continuous
Frequency response	2 Hz – 20 kHz ( $\pm 0.5$ dB)
Wavelength	780 – 790 nm
Signal-to-noise ratio	More than 90 dB
Dynamic range	More than 90 dB

## Tape deck section

Recording system	4-track 2-channel stereo
Frequency response	50 – 13,000 Hz ( $\pm 3$ dB), using Sony TYPE I cassette
Wow and flutter	$\pm 0.15\%$ W.Peak (IEC) 0.1% W.RMS (NAB) $\pm 0.2\%$ W.Peak (DIN)

## Tuner section

FM stereo, FM/AM superheterodyne tuner

### FM tuner section

Tuning range	87.5 – 108.0 MHz
Antenna	FM lead antenna
Antenna terminals	75 ohms unbalanced
Intermediate frequency	10.7 MHz

### AM tuner section

Tuning range	
Pan-American models:	530 – 1,710 kHz (with the interval set at 10 kHz) 531 – 1,710 kHz (with the interval set at 9 kHz)
European and Middle Eastern models:	531 – 1,602 kHz (with the interval set at 9 kHz)

### Other models:

	530 – 1,710 kHz (with the interval set at 10 kHz) 531 – 1,602 kHz (with the interval set at 9 kHz)
Antenna	AM loop antenna
Antenna terminals	External antenna terminal
Intermediate frequency	450 kHz

**continued**

## Specifications (continued)

### Speaker

#### North American model:

##### Front speaker SS-RG55 for MHC-GX40

Speaker system	3-way, 3-unit, bass-reflex type
Speaker units	
Woofer:	13 cm, cone type
Tweeter:	5 cm, cone type
Super tweeter:	2 cm, dome type
Nominal impedance	6 ohms
Dimensions (w/h/d)	Approx. 200 × 325 × 237 mm
Mass	Approx. 3.6 kg net per speaker

##### Sub woofer speaker SS-WG99 for MHC-GX40

Speaker system	Passive sub woofer
Speaker units	
Woofer:	15 cm, cone type
Nominal impedance	12 ohms
Dimensions (w/h/d)	Approx. 210 × 325 × 239 mm
Mass	Approx. 4.0 kg

#### Canadian model:

##### Front speaker SS-RG66A for MHC-GX30

Speaker system	3-way, 3-unit, bass-reflex type
Speaker units	
Sub Woofer:	13 cm, cone type
Woofer:	13 cm, cone type
Tweeter:	5 cm, cone type
Nominal impedance	6 ohms
Dimensions (w/h/d)	Approx. 215 × 356 × 260 mm
Mass	Approx. 4.2 kg net per speaker

#### Other models:

##### Front speaker SS-RG66A for MHC-RG33

Speaker system	3-way, 3-unit, bass-reflex type
Speaker units	
Sub Woofer:	13 cm, cone type
Woofer:	13 cm, cone type
Tweeter:	5 cm, cone type
Nominal impedance	6 ohms
Dimensions (w/h/d)	Approx. 215 × 356 × 260 mm
Mass	Approx. 4.2 kg net per speaker

##### Front speaker SS-RG55 for MHC-GX20/RG22

Speaker system	3-way, 3-unit, bass-reflex type
Speaker units	
Woofer:	13 cm, cone type
Tweeter:	5 cm, cone type
Super tweeter:	2 cm, dome type
Nominal impedance	6 ohms
Dimensions (w/h/d)	Approx. 200 × 325 × 237 mm
Mass	Approx. 3.6 kg net per speaker

## General

### Power requirements

North American models:	120 V AC, 60 Hz
European models:	230 V AC, 50/60 Hz
Australian model:	230 – 240 V AC, 50/60 Hz
Argentine models:	220 V AC, 50/60 Hz
Mexican models:	120 V AC, 60 Hz
Middle Eastern models:	120 – 127/220/230 – 240 V AC, 50/60 Hz
	Adjustable with voltage selector
Thai model:	220 V AC, 50/60 Hz
Other models:	120 V, 220 V or 230 – 240 V AC, 50/60 Hz
	Adjustable with voltage selector

### Power consumption

USA models:	
MHC-GX40:	140 watts
MHC-GX20:	105 watts
Canadian models:	
MHC-GX40:	140 watts
MHC-GX30:	125 watts
MHC-GX20:	105 watts
European models:	
MHC-RG33:	125 watts
	0.5 watts (at the Power Saving Mode)
MHC-RG22:	105 watts
	0.5 watts (at the Power Saving Mode)
Other models:	
MHC-RG33:	125 watts
MHC-RG22:	105 watts
Dimensions (w/h/d)	Approx. 280 × 325 × 412 mm

### Mass

North American models:	
HCD-GX40:	Approx. 9.0 kg
HCD-GX30:	Approx. 9.0 kg
HCD-GX20:	Approx. 8.5 kg
European models:	
HCD-RG33:	Approx. 9.0 kg
HCD-RG22:	Approx. 8.5 kg
Other models:	
HCD-RG33:	Approx. 9.5 kg
HCD-RG22:	Approx. 9.0 kg

Supplied accessories:	Remote Commander (1) Batteries (2) AM loop antenna (1) FM lead antenna (1) Front speaker pads (8)
-----------------------	---

Design and specifications are subject to change without notice.



