

Portable Memory Stick Audio Player
Network Walkman

Operating Instructions

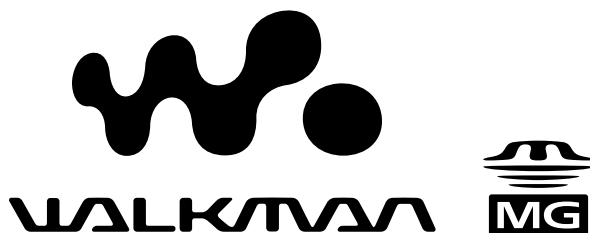

NW-MS9

For the customers in the United States

Owner's Record

The model and serial numbers are located inside the "Memory Stick" slot cover of the player (see page 7). Record the serial number in the space provided below. Refer to them whenever you call your Sony dealer regarding this product.

Model No. NW-MS9

Serial No. _____

INFORMATION:

This equipment has been tested and found to comply with the limits for a Class B digital device, pursuant to Part 15 of the FCC Rules. These limits are designed to provide reasonable protection against harmful interference in a residential installation. This equipment generates, uses, and can radiate radio frequency energy and, if not installed and used in accordance with the instructions, may cause harmful interference to radio communications.

However, there is no guarantee that interference will not occur in a particular installation. If this equipment does cause harmful interference to radio or television reception, which can be determined by turning the equipment off and on, the user is encouraged to try to correct the interference using one or more of the following measures:

- Reorient or relocate the receiving antenna.
- Increase the separation between the equipment and receiver.
- Connect the equipment into an outlet on a circuit different from that to which the receiver is connected.
- Consult the dealer or an experienced radio/TV technician for help.

You are cautioned that any changes or modifications not expressly approved in this manual could void your authority to operate this equipment.

If you have any questions about this product, you may call:

Sony Direct Response Center 1-(800)-222-7669

or write to:

Sony Direct Response Center 12451 Gateway Blvd. Fort Myers, FL 33913

Declaration of Conformity

Trade Name: SONY
Model No.: NW-MS9
Responsible Party: Sony Electronics Inc.
Address: 1 Sony Drive,
Park Ridge, NJ.07656 USA
Telephone No.: 201-930-6972

This device complies with Part 15 of the FCC Rules. Operation is subject to the following two conditions: (1) This device may not cause harmful interference, and (2) this device must accept any interference received, including interference that may cause undesired operation.



For the customers in the Netherlands

Voor de Klanten in Nederland



Gooi de batterij niet weg, maar lever hem in als KCA

Note on the supplied "MagicGate Memory Stick"

For the customers in the United States

This device complies with Part 15 of the FCC Rules. Operation is subject to the following two conditions:

- (1) This device may not cause harmful interference, and
- (2) this device must accept any interference received, including interference that may cause undesired operation.

For the customers in Canada

This class B digital apparatus complies with Canadian ICES-003.

Notice for users

On the supplied software

- Copyright laws prohibit reproducing the software or the manual accompanying it in whole or in part, or renting the software without the permission of the copyright holder.
- In no event will SONY be liable for any financial damage, or loss of profits, including claims made by third parties, arising out of the use of the software supplied with this player.
- In the event a problem occurs with this software as a result of defective manufacturing, SONY will replace it. However, SONY bears no other responsibility.
- The software provided with this player cannot be used with equipment other than that which is so designated.
- Please note that, due to continued efforts to improve quality, the software specifications may be changed without notice.
- Operation of this player with software other than that provided is not covered by the warranty.

Program ©2000 Sony Corporation
Documentation ©2001 Sony Corporation

Table of Contents

Overview	4
What you can do with your Network Walkman	4
Other features	5
On “MagicGate Memory Stick”	5

Getting Started

Step 1: Unpacking	7
Step 2: Charging the rechargeable battery	8

Basic Operations

Transferring songs from the computer to the “Memory Stick” (Check- Out)	9
Listening to music with Network Walkman	11
On other operations	12
On the display	12

Advanced Operations

Playing tracks repeatedly (REPEAT)	13
Adjusting the sound	14
Emphasizing the bass sound (MEGA BASS)	14
Protecting your hearing (AVLS)	14
Changing the display mode	15
Locking the controls (HOLD)	16
Changing the settings	16
To set a reasonable volume (Volume preset functions) ..	16
To turn off the beep sound (BEEP)	17
To change the display backlight setting (LIGHT)	18
To set the date and time (DATE – TIME)	18
To erase the “Memory Stick” (ERASE)	20
To format the “Memory Stick” (FORMAT)	21
Menu	22



Other Information

Precautions	23
Notes on the rechargeable battery	24
Troubleshooting	25
To reset the player	25
What happened ?	25
Error messages	28
Specifications	30
Glossary	31
Looking at the controls	33
Index	34

This manual explains how to operate Network Walkman. For details on how to use the supplied software (OpenMG Jukebox), refer to the OpenMG Jukebox Operating Instructions.

Network Walkman is a trademark of Sony Corporation.

OpenMG and its logo are trademarks of Sony Corporation.

“MagicGate Memory Stick,” , “Memory Stick,” , Network Walkman are trademarks of Sony Corporation.

“MagicGate” and **MAGICGATE** are trademarks of Sony Corporation.

WALKMAN is a registered trademark of Sony Corporation.

US and foreign patents licensed from Dolby Laboratories.

All other trademarks and registered trademarks are trademarks or registered trademarks of their respective holders.

Overview

What you can do with your Network Walkman

Network Walkman is a portable Memory Stick audio player.

You can easily transfer digital audio files from your computer to the “MagicGate Memory Stick” using this product, and carry it anywhere to enjoy.

- 1** Store digital audio files on your computer.*

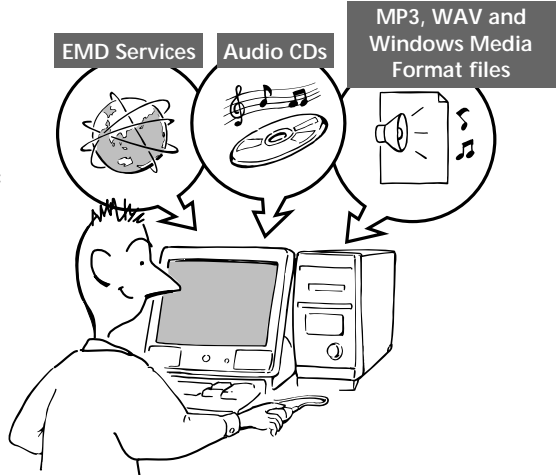

- 2** Transfer the files to the Network Walkman.

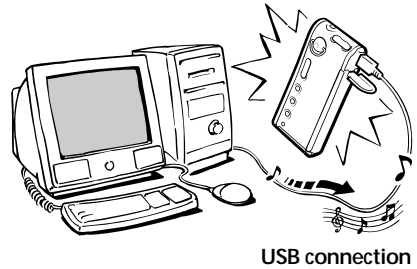

- 3** Listen to your Network Walkman.



Other features

- Compact size, light weight.
- Skip-proof: you can enjoy uninterrupted enjoyment of music during physical activities such as jogging or commuting.
- Approximately 10 hours of continuous playback with a rechargeable nickel hydride battery.
- Recordable time: up to 60 min., 80 min., 120 min.**, on the supplied 64MB “MagicGate Memory Stick.”
- Backlight LCD screen: song titles and artist names can be displayed.
- High speed data transfer using the supplied USB cable.
- OpenMG Jukebox software enables you to record compact discs using the ATRAC3 format (high sound quality, high compression) to the hard drive.

* The copyright protection technology of Network Walkman conforms to the SDMI (Secure Digital Music Initiative) specifications.

**Differs according to the bit rate when recording. In this case, the figures for the recordable time are when recording on a 64MB “MagicGate Memory Stick” at 132kbps, 105kbps, and 66kbps.

NOTES:

- The recorded music is limited to private use only. Use of the music beyond this limit requires permission of the copyright holders.
- Sony is not responsible for music files that are not saved on your computer due to unsuccessful recording from CD or music downloading.

On “MagicGate Memory Stick”

What is a “Memory Stick”?

“Memory Stick” is a compact, portable and versatile Integrated Circuit recording medium with a data capacity that exceeds a floppy disk. “Memory Stick” is specially designed for exchanging and sharing digital data among “Memory Stick” compatible products. Because it is removable, the “Memory Stick” can also be used for external data storage.

Types of “Memory Stick”

There are two types of “Memory Stick”:

- “MagicGate Memory Stick” that is equipped with “MagicGate” copyright protection technology.
 - “Memory Stick” that is not equipped with “MagicGate” copyright protection technology.
- (See “Glossary” on page 31 for details.)

Use a “MagicGate Memory Stick” with this player.

A 64-MB “MagicGate Memory Stick” is supplied with this product.

When you purchase a spare “Memory Stick” for your Network Walkman, be sure to ask for a “MagicGate Memory Stick,” which is distinguished by the  logo.

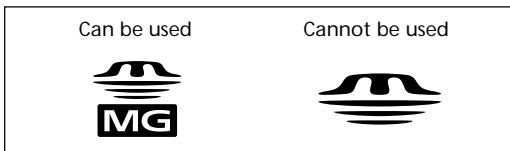

Note

The Memory capacity of a “MagicGate Memory Stick” supported by this product is 128MB.

Overview (continued)

What is “MagicGate”?

“MagicGate” is a copyright protection technology for “MagicGate Memory Stick” and compliant products, such as Network Walkman. Authentication ensures that protected content is transferred only between compliant devices and “MagicGate Memory Stick,” and that protected content is recorded and transferred in an encrypted format to prevent unauthorized copying or playback.

Notes on use

To avoid damaging data, do not

- release the “Memory Stick” or unplug the USB cable during reading or writing of data.
- use the “Memory Stick” in a location subject to static electricity or electric noise.

On formatting the “Memory Stick”

The “Memory Stick” is shipped with a FAT format as the standard format.

To format the “Memory Stick,” please use devices conformable with the “Memory Stick.”

When formatting the “Memory Stick,” do not use the format function on the Windows Explorer.

“FORMAT ERR” (page 28) is displayed and you cannot playback using Network Walkman. To

format the “Memory Stick,” do one of the following:

- Follow the instructions, “To format the ‘Memory Stick’” on page 21.
- Use the supplied OpenMG Jukebox software.

For details on how to use the OpenMG Jukebox, refer to the online Help for Network Walkman.

On the Windows Explorer

When you connect Network Walkman to your computer with the supplied USB cable, you can display the data recorded on a “Memory Stick” as an external drive (for example, as the D drive) using the Windows Explorer.

- Data is stored in a folder called “Hifi” Folder. Do not edit data that is stored in the “Hifi” Folder. You cannot playback data that has been copied or edited using the Windows Explorer.
- You can display data that has been recorded on other “Memory Stick” compatible devices (JPEG data, MPEG data, etc.).

For information on how to handle data except in the “Hifi” Folder, refer to the instruction manual that comes with the equipment with which the recording has been done.

Step 1: Unpacking

Your Memory Stick Audio Player comes with the following items.

- Memory Stick Player (1)
- Earphones (1)

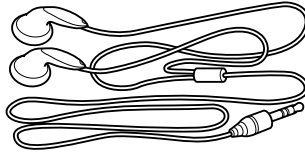
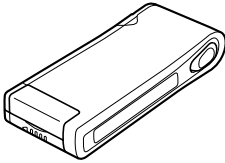

- “MagicGate Memory Stick” (1)

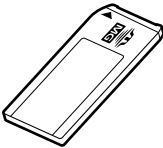

- USB cable (1)

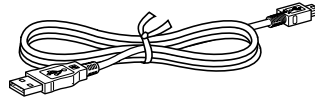

- Rechargeable battery (1)



- “Memory Stick” storage case (1)
- Rechargeable battery carrying case (1)
- Carrying pouch (1) (Except for U.S.A model)
- Key ring (1)
- CD-ROM
(OpenMG Jukebox installation disc) (1)
- NW-MS9 Operating Instructions (1)
- OpenMG Jukebox
Operating Instructions (1)

- Battery charger (1)
- AC plug adaptor (1)
(Except for U.S.A, Europe, Hong Kong,
Korea, and Australia model)

About the Serial Number

The serial number provided for your device is required for the customer registration. The number is on a label on the inside of the Memory Stick slot cover.

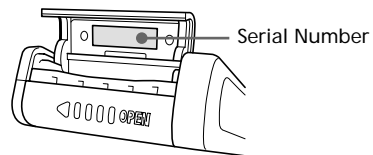

Step 2: Charging the rechargeable battery

Please charge the battery before using the player.

1 Charge the battery.

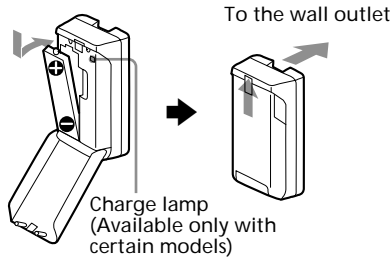

For U.S.A and European models:
Full charging takes about 7 hours.

For other countries:
After about 1.5 hours, charging ends and the lamp turns off. (To get maximum performance from battery, continue charging it for another hour after the lamp turns off.)

Notes

- The shape of the supplied charger varies depending on your country.
- Please charge the battery where the temperature is 0°C to 35°C.

2 Insert the fully charged battery in the battery compartment.

Slide the battery cover in the direction of the arrow to open.

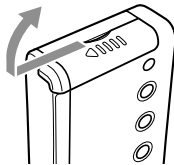

Insert the negative end (-) of the battery first.

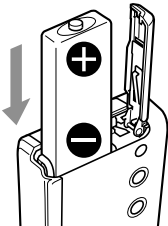

If the battery compartment lid is accidentally detached, attach it as illustrated.

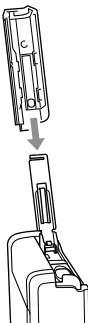

Battery duration

About 10 hours.

About the remaining battery charge indication

The battery icon in the display changes as shown below.

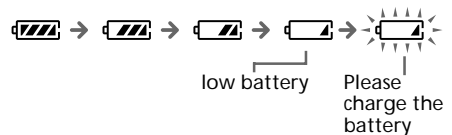

If "LOW BATT" is displayed in the display, you need to recharge the battery.

Transferring songs from the computer to the “Memory Stick” (Check-Out)

In order to check-out digital audio files from your computer, first you must install the supplied OpenMG Jukebox software and then import digital audio files to OpenMG Jukebox.

For details, refer to the OpenMG Jukebox operating instructions.

1 Connect Network Walkman to your computer.

- ① Insert “MagicGate Memory Stick.”

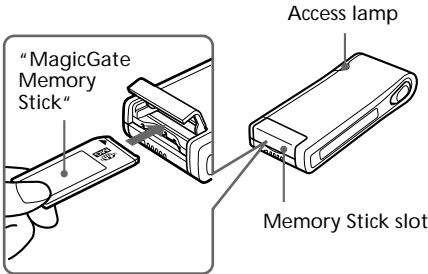

Notes

- When connecting Network Walkman to your computer, make sure the erasure prevention switch of the “Memory Stick” (page 23) is OFF .
- Insert the “Memory Stick” into the slot until it clicks into place.

- ② Connect Network Walkman to your computer.

Connect the narrow connector of the supplied dedicated USB cable into the dedicated USB jack on Network Walkman, then the wide connector to the USB jack of your computer. “CONNECT” appears in the display.

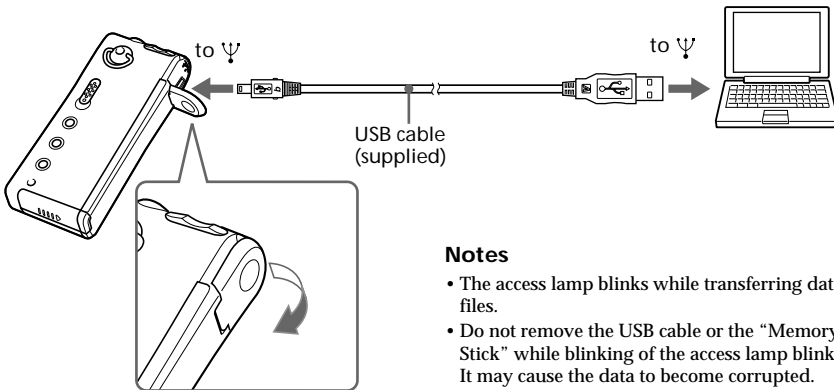

Notes

- The access lamp blinks while transferring data files.
- Do not remove the USB cable or the “Memory Stick” while blinking of the access lamp blinks. It may cause the data to become corrupted.

Notes

- Do not connect more than two USB devices to your computer. Normal operation will not be guaranteed.
- Use of this player with a USB hub or a USB extension cable is not guaranteed.
- A malfunction may occur depending on the USB devices connected at any one time.
- When connecting Network Walkman to your computer for the first time, check if the OpenMG Jukebox icon appears on the tasktray.

If the icon appears, remove it from the tasktray. And then connect Network Walkman to your computer with the supplied dedicated USB cable and start the OpenMG Jukebox software. (This procedure is only necessary the first time you connect to your computer.)

Transferring songs from the computer to “Memory Stick” (Check-Out) (continued)

- 2** Transfer the music file to the “Memory Stick” (Check-out).
For details on how to operate, refer to the OpenMG Jukebox operating instructions.

When the cover of the USB connector is released.

After releasing the cover, to reconnect, follow the steps below.

- ① Insert the stud of the cover into the hole of the Network Walkman as shown.
- ② Rotate the cover in the direction of the arrow and insert the other stud into the opposite hole as shown.

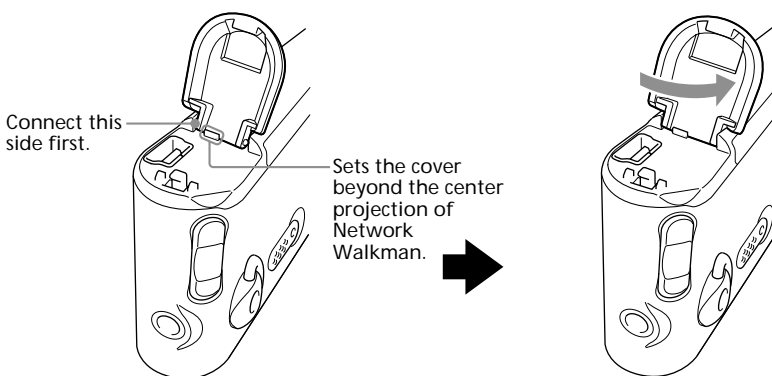

Tip

To transfer the song back to the computer (check-in), refer to the OpenMG Jukebox software instruction manual or the online help.

Listening to music with Network Walkman

Please charge the battery before use (see page 8).

Note

When using Network Walkman, be sure to disconnect it from the computer.

1 Insert a recorded "MagicGate Memory Stick" into Network Walkman.

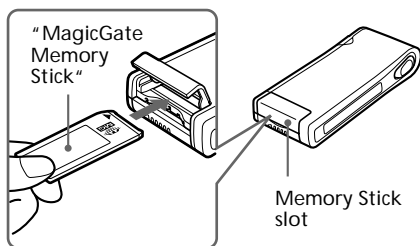

When the "Memory Stick" is inserted into the slot, "ACCESS" appears.

All the music files and total playing hours appear.

2 Connect the headphones/earphones.

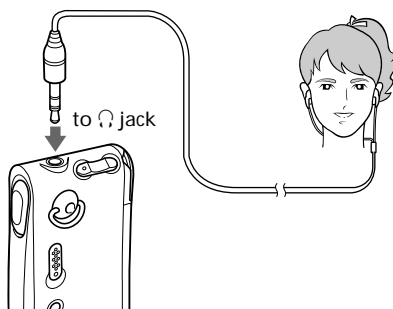

3 Start playback.

① Press the Seesaw key.

② Press the VOLUME +/- button up or down to adjust the volume.

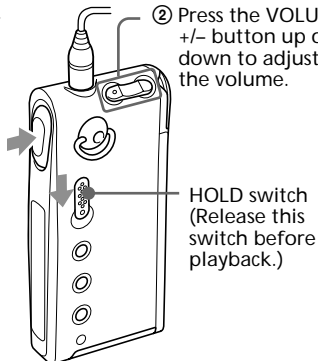

Playback stops automatically when the music reaches the end (only when REPEAT OFF is selected).

If playback does not start

The HOLD switch may be switched down. Please release it up (page 16).

To stop playback

Press the Seesaw key.

To adjust the volume

The volume can be set in PRESET and MANUAL mode (page 16).

Tip

If you do not operate the player for 10 seconds while in stop mode, the display automatically turns off. When scrolling song titles, etc., the display turns off after scrolling is finished.

On other operations

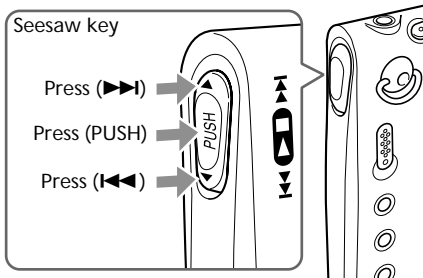

To	Operation of the Seesaw key
Go to the beginning of the next track	Press (▶▶▶) once.
Go to the beginning of the succeeding tracks ¹⁾	Press (▶▶▶) repeatedly.
Go to the beginning of the actual track	Press (◀◀◀) once.
Go to previous tracks ¹⁾	Press (◀◀◀) repeatedly.
Go forward ²⁾	During playback, press (▶▶▶) and hold.
Go backward ²⁾	During playback, press (◀◀◀) and hold.

¹⁾ Pressing and holding (▶▶▶) of the Seesaw key during stop mode allows you to go to the beginning of the next and succeeding tracks continuously.
Also, pressing and holding (◀◀◀) of the Seesaw key during the stop mode allows you to go to the beginning of the previous and further tracks continuously.

²⁾ Passing five seconds after starting fast forwarding or fast rewinding operations, its speed increases.

To take out the "Memory Stick"

Open the cover of the "Memory Stick" slot, then slightly push and release the "Memory Stick."

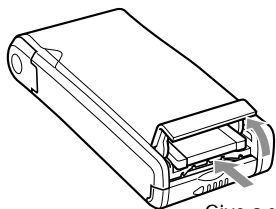

Give a slight push once.

On the display

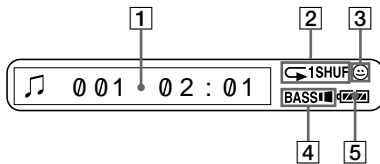

- 1** Text/graphic information display (page 15)
Display track number, song title, current date and time (page 18) and menu.
In the graphic mode, Spectrum analyzer, etc. are displayed.
Press the DISPLAY button to change the display mode. See "Changing the display mode" on page 15 for details.
- 2** Playback mode indication (page 13)
The selected playback mode is displayed.
- 3** AVLS indication (page 14)
The indication lights up while the AVLS function is activated.
- 4** MEGA BASS indication (page 14)
The indication lights up while the MEGA BASS function is activated.
- 5** Battery remain indication (page 8)
The remaining battery power is displayed.

Playing tracks repeatedly (REPEAT)

You can play tracks repeatedly in three ways— all repeat, single repeat and shuffle repeat.

Menu	Playback mode	Display indication*
REP OFF	normal	none
REP ALL	all tracks repeatedly	↻
REP 1	current track repeatedly	↻ 1
REP SHUF	all tracks repeatedly in random order	↻ SHUF

* The display indication appears after step 4.

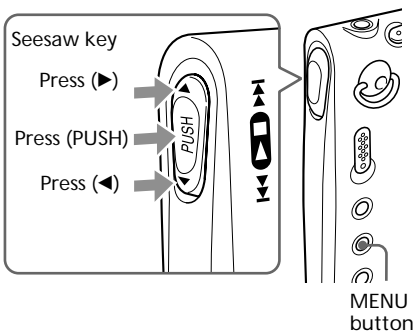

- 1 Press the MENU button. The menu is displayed.

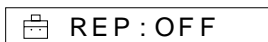

- 2 Press (PUSH) of the Seesaw key. "OFF" blinks.

- 3 Press ◀ or ▶ of the Seesaw key to select "ALL", "1", "SHUF", or "OFF."



- 4 Press (PUSH) of the Seesaw key. The selected playback mode indication lights.

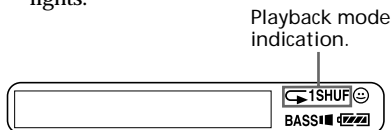

- 5 Press the MENU button. The display returns to normal.

To exit from the Menu mode

Select [RETURN] in the menu or press the MENU button.

To cancel the REPEAT mode

Select OFF in step 3.

Notes

- If there is no "Memory Stick" inserted, "REP : ---" appears in the display, and repeat mode cannot be selected.
- Removing the "Memory Stick" from the slot, the setting of "REPEAT" returns to "REP : OFF."

Adjusting the sound

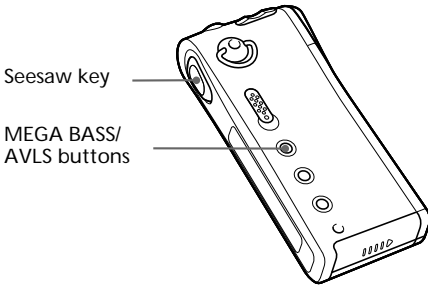

Emphasizing the bass sound (MEGA BASS)

Mega Bass function intensifies low frequency sound for richer quality audio reproduction.

Press the MEGA BASS/AVLS button.

Each time you press the MEGA BASS/AVLS button, the MEGA BASS indication changes as follows:



Display indication	Sound quality
BASS I	Mega Bass (moderate effect)
BASS II	Mega Bass (strong effect)
none	normal play

Note

If the sound becomes distorted when emphasizing the bass, turn down the volume.

To cancel the MEGA BASS effect

Press the MEGA BASS/AVLS button repeatedly until the MEGA BASS indication goes off.

Protecting your hearing (AVLS)

The AVLS (Automatic Volume Limiter System) function keeps down the maximum volume to protect your ears.

Press and hold the MEGA BASS/AVLS button more than one-half second.

The 😊 (AVLS) indication lights up in the display.

The volume is kept to a moderate level.

To cancel AVLS

Press and hold the MEGA BASS/AVLS button until the 😊 indication goes off.

Changing the display mode

Information for the track numbers or song titles appears on the display in playback or stop mode.

You can change the display mode.

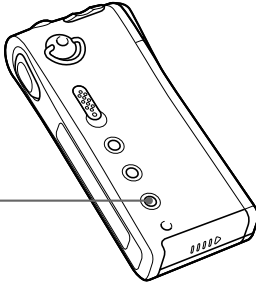

Press the DISPLAY button.

Each time you press the DISPLAY button, the display changes as shown below.

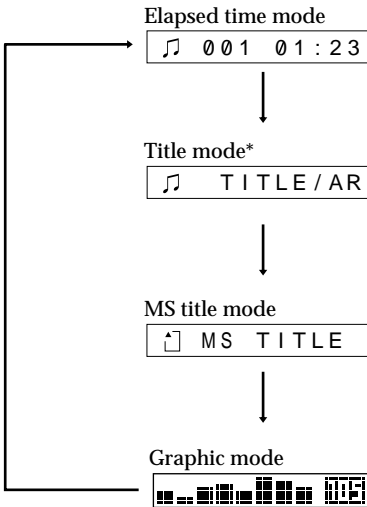

* If the files have no song titles or artist names, "Track001," etc. appears.

• Elapsed time mode

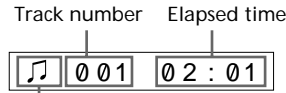

Play status
 During playback: or is displayed alternately.
 In stop mode: is displayed.
 While locating tracks: or is displayed.
 While searching a point in a track: or is displayed.

• Title mode

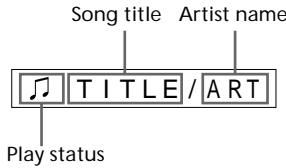

• MS title mode

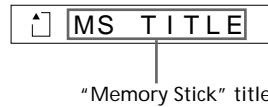

• Graphic mode

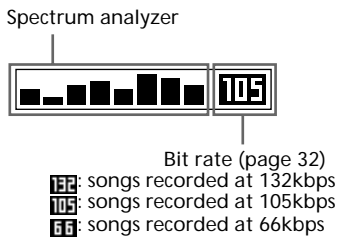

• While searching a point in a track (Graphic mode):

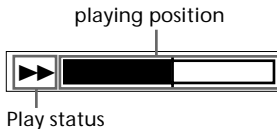

While fast forwarding, fast rewinding, or during continuous search operations, the current playing position is displayed.

Locking the controls (HOLD)

To prevent the controls from being accidentally operated when you carry the player, use this function.

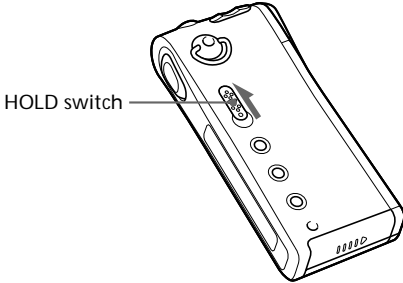

Slide the HOLD switch in the direction of the arrow.

No controls will be able to operate.

If you press buttons while the HOLD switch is ON, "HOLD" appears in the display.

To release the Hold function

Slide the HOLD switch in the opposite direction of the arrow.

Changing the settings

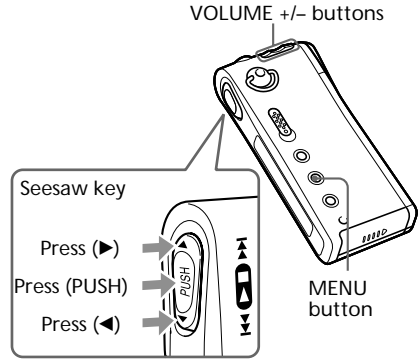

To set a reasonable volume (Volume preset functions)

There are two modes of adjusting the volume.

Manual mode: By pressing the "VOLUME +/-" button, you can change the setting from 0 to 31.

Preset mode: You can switch to any of three preset levels: LO, MID, or HI .

- 1 Press the MENU button.
The menu is displayed.

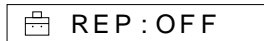

- 2 Press ◀ or ▶ of the Seesaw key to display "VOL : MAN."

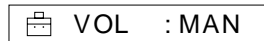

- 3 Press (PUSH) of the Seesaw key.
"MAN" blinks.

- 4 Press ◀ or ▶ of the Seesaw key to display "VOL : SET>."

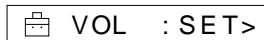

-
- 5** Press (PUSH) of the Seesaw key.
 “VOL LO xx”* blinks.
 * xx is a numeric value.



-
- 6** Press the “VOLUME +/-” button to set the settings of LO, MID, or HI.
- ① Sets numeric of LO.
 - ② Press ► to display “VOL MID xx,” and set it using “+/-.”
 - ③ Do the same to set “VOL HI xx.”

-
- 7** Press (PUSH) of the Seesaw key.

-
- 8** Press the MENU button.
 The display returns to normal.
 While the above settings, the volume can be adjusted to LO, MID, or HI.

To exit from the Menu mode
 Select [RETURN] in the menu or press the MENU button.

Note
 If AVLS is set (page 14), the volume may be lower than previous settings.

To turn off the beep sound (BEEP)

BEEP ON: a beep will sound to indicate that operation has been accepted.

BEEP OFF: no beep sound will be heard.

-
- 1** Press the MENU button.
 The menu is displayed.

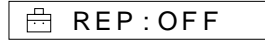

-
- 2** Press ◀ or ▶ of the Seesaw key to display “BEEP : ON.”



-
- 3** Press (PUSH) of the Seesaw key.
 “ON” blinks.

-
- 4** Press ◀ or ▶ of the Seesaw key to display “OFF.”



-
- 5** Press (PUSH) of the Seesaw key.

-
- 6** Press the MENU button.
 The display returns to normal.

To exit from the Menu mode
 Select [RETURN] in the menu or press the MENU button.

To turn on the beep sound
 Select ON in step 4.

Changing the settings (continued)

To change the display backlight setting (LIGHT)

Menu	Backlight mode
OFF	always off
ON	turns on for three seconds after each operation (or until scrolling is complete)

- 1 Press the MENU button.
The menu is displayed.

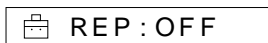

- 2 Press ◀ or ▶ of the Seesaw key to display "LIGHT : ON."



- 3 Press (PUSH) of the Seesaw key.
"ON" blinks.

- 4 Press ◀ or ▶ of the Seesaw key to display selections.



- 5 Press (PUSH) of the Seesaw key.

- 6 Press the MENU button.
The display returns to normal.

To exit from the Menu mode

Select [RETURN] in the menu or press the MENU button.

To set the date and time (DATE - TIME)

You can set the current date and time and display it. To play a music item with a playback period restriction, you need to set the date and time.

- 1 Press the MENU button.
The menu is displayed.

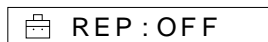

- 2 Press ◀ or ▶ of the Seesaw key to display "DATE-TIME."



- 3 Press (PUSH) of the Seesaw key.
The "DATE" display appears, and the year indication "y" blinks.

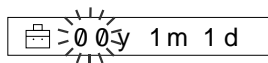

- 4 Press ◀ or ▶ of the Seesaw key to select the year number "y."

- 5 Press (PUSH) of the Seesaw key.
The month indication "m" blinks.

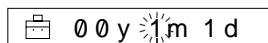

- 6 Do the same to set the month "m" and the day "d," and press (PUSH) of the Seesaw key.

The "TIME" display appears, The hour indication "h" blinks.

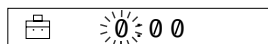

7 Do the same to set the month “h” and the day “m,” and press (PUSH) of the Seesaw key.

8 Press the MENU button.
The display returns to normal.

To switch between 24 hour display and 12 hour display

Press the DISPLAY button during the setting in step 7.

To exit from the Menu mode

Select [RETURN] in the menu or press the MENU button.

To display the current time

Press the DISPLAY button more than one-half second.

You can display the current time during pressing.

Note

If the unit is not used for a long time, it may reset your settings of the date and time.

To erase the “Memory Stick” (ERASE)

You can erase music data from the “Memory Stick” one by one.

Confirm the contents before erasing.

-
- 1** Press the MENU button.
The menu is displayed.

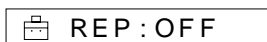

-
- 2** Press ◀ or ▶ of the Seesaw key to display “ERASE.”



If “ERASE” does not appear in the menu, erasing is not available.

-
- 3** Press (PUSH) of the Seesaw key.
The current track number blinks.



-
- 4** Press ◀ or ▶ of the Seesaw key to select the track numbers you want to erase.

-
- 5** Press (PUSH) of the Seesaw key.
“N” blinks.
Playback starts from the first track. If you do not operate it for more than 10 seconds while in playback mode, erasing automatically turns off.



-
- 6** Press ◀ or ▶ of the Seesaw key to display “Y.”



-
- 7** Press (PUSH) of the Seesaw key.
“ERASE 001?” appears.

-
- 8** Press (PUSH) of the Seesaw key.
“ERASING” appears, and music data is erased from the “Memory Stick.”
After erasing is complete, “COMPLETE” appears, and returns to the display in step 2.

-
- 9** Press the MENU button.
The display returns to normal.
-

To exit from the Menu mode

Select [RETURN] in the menu or press the MENU button.

To cancel the erasing

Select “N” in step 5, or press the Seesaw key to select ◀ or ▶ in step 7.

Notes

- You cannot erase while playback (“ERASE” will not be displayed).
- If the erasure prevention switch of the “Memory Stick” is ON, “MS LOCKED” appears in the display, and you cannot erase the “Memory Stick.”
- Do not take out the “Memory Stick” when “ERASING” is displayed.

Tip

If the songs are erased from the “Memory Stick,” OpenMG Jukebox recognizes them as songs to be checked in when the “Memory Stick” is connected to the original computer that you used for Check-out.

Therefore, the remaining Check-out count increases automatically.

To format the “Memory Stick” (FORMAT)

You can use the Network Walkman player to format the “Memory Stick”.

If formatted, all data previously recorded on the “Memory Stick” will be erased. Be sure to check the data of the “Memory Stick” before formatting (data recorded using other devices will also be erased).

A commercially available “Memory Stick” is already formatted at the factory.

The supplied “Memory Stick” is also formatted.

Note

You cannot use a “Memory Stick” that has been formatted using the computer (page 6).

- 1 Press the MENU button.
The menu is displayed.



- 2 Press ◀ or ▶ of the Seesaw key to display “FORMAT.”



If “FORMAT” does not appear in the menu, formatting is not available.

- 3 Press (PUSH) of the Seesaw key.
“N” blinks.



- 4 Press ◀ or ▶ of the Seesaw key to display “Y.”



- 5 Press (PUSH) of the Seesaw key.
“FORMAT?” appears.

- 6 Press (PUSH) of the Seesaw key.
“FORMATING” blinks, and starts formatting of the “Memory Stick.”
When formatting is finished,
“COMPLETE” appears in the display,
and returns to the menu in step 2.

- 7 Press the MENU button.
The display returns to normal.

To exit from the Menu mode

Select [RETURN] in the menu or press the MENU button.

To cancel the formatting

Select “N” in step 3, or press the Seesaw key to select ◀ or ▶ in step 5.

Notes

- You cannot format while playback (“FORMAT” will not be displayed).
- If the erasure prevention switch of the “Memory Stick” is ON, “MS LOCKED” appears in the display, and you cannot format the “Memory Stick.”
- Do not take out the “Memory Stick” when “FORMATING” is displayed.

Tip

If the songs are formatted from the “Memory Stick,” OpenMG Jukebox recognizes them as songs to be checked in when the “Memory Stick” is connected to the original computer that you used for Check-out.

Therefore, the remaining Check-out count increases automatically.

Menu

Press the MENU button to display the menu.

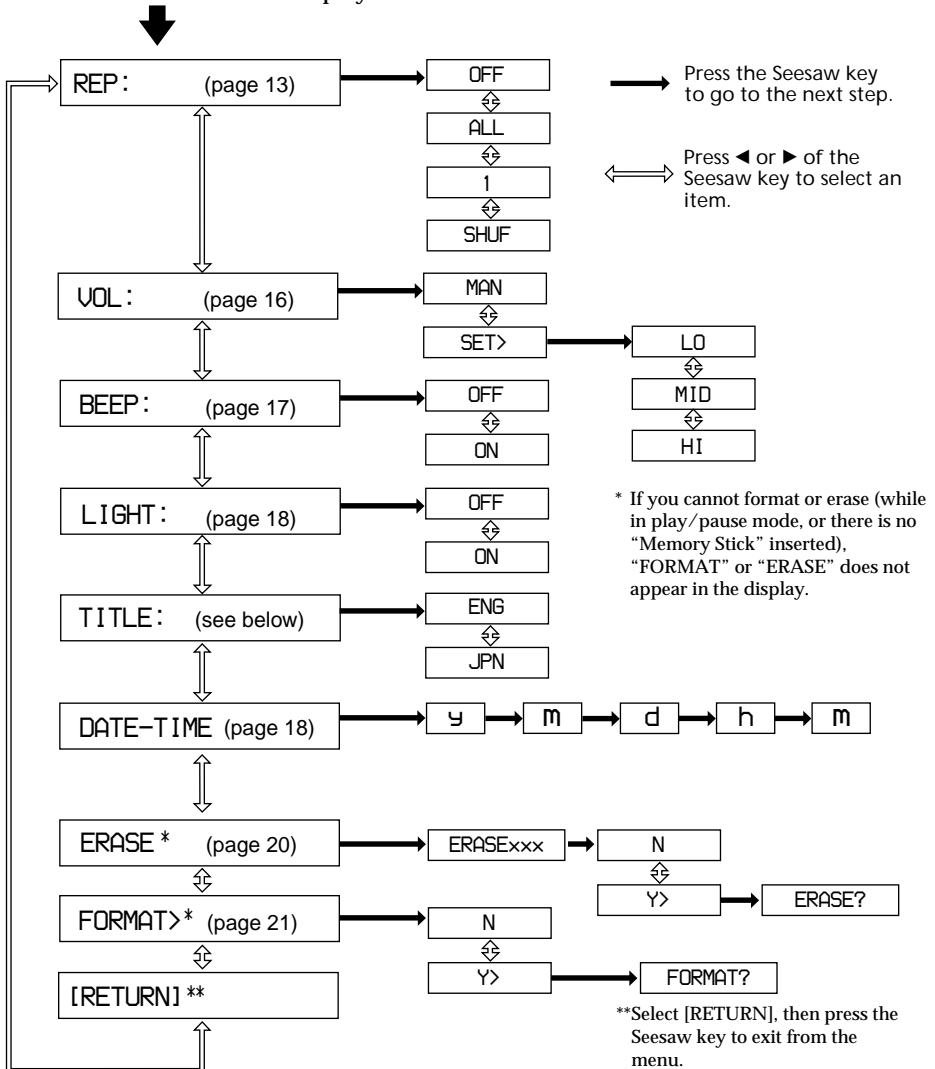

On the TITLE menu

You can choose between “ENG” (English) and “JPN” (Japanese). This function will be available in the future when the OpenMG Jukebox software is upgraded and you can use both English and Japanese for album and song titles.

About “>”

Selecting “>” on the display, waits your operations on the next window.

Precautions

On safety

- When you carry the supplied rechargeable battery, be sure to put it in the supplied rechargeable battery carrying case. Carrying the rechargeable battery without the case may cause a short-circuit with metallic objects such as coins, key rings, or necklace. As a result, a heat may generate.
- Incorrect battery usage may lead to leakage of battery fluid or bursting batteries. To prevent such accidents, observe the following precautions:
 - Install batteries with the + and – poles aligned correctly.
 - Do not charge dry batteries.
- If a battery leak should develop, carefully and thoroughly wipe away battery fluid from the battery compartment before inserting new one.

On installation

Never use the player where it will be subjected to extremes of light, temperature, moisture or vibration.

On handling the “Memory Stick”

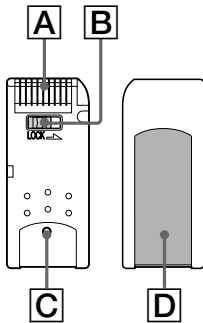

- When the “Memory Stick” erasure prevention switch is set to “LOCK,” data cannot be recorded, erased or edited. (A)
- The tactile protrusion on the rear surface of “MagicGate Memory Stick” distinguishes it from a general “Memory Stick.” (C)
- Do not attach any other material than the supplied label on the label space. (D)
- Attach the label so that it does not stick out from the proper attachment location.

- Do not touch the “Memory Stick” connector with your finger or metallic objects. (A)
- Do not bend, drop or apply strong shock to the “Memory Stick.”
- Do not disassemble or modify the “Memory Stick.”
- Do not allow the “Memory Stick” to get wet.
- Do not use or store the “Memory Stick” in a location that is subject to:
 - Extremely high temperature, such as in a car parked in the sun
 - Direct sunlight
 - High humidity or places with corrosive substances
- To prolong the life of the “Memory Stick,” use the supplied storage case.

On the headphones/earphones

Road Safety

Do not use headphones/earphones while driving, cycling, or operating any motorized vehicle. It may create a traffic hazard and is illegal in many areas. It can also be potentially dangerous to play your player at high volume while walking, especially at pedestrian crossings. You should exercise extreme caution or discontinue use in potentially hazardous situations.

Preventing hearing damage

Avoid using headphones/earphones at high volume. Hearing experts advise against continuous, loud and extended play. If you experience a ringing in your ears, reduce the volume or discontinue use.

Caring for others

Keep the volume at a moderate level. This will allow you to hear outside sounds and to be considerate of the people around you.

Precautions (continued)

On cleaning

- Clean the player casing with a soft cloth slightly moistened with water or a mild detergent solution. Do not use any type of abrasive pad, scouring powder or solvent such as alcohol or benzene as it may mar the finish of the casing.
- Clean the headphones/earphones plug and extension cord plug periodically.

If you have any questions or problems concerning your Network Walkman, please consult your nearest Sony dealer. (If trouble occurred when the "Memory Stick" was in the player, we recommend that the "Memory Stick" be left in the player when you consult your Sony dealer so that the cause of trouble may be better understood.)

Notes on the rechargeable battery

- Be sure to use the supplied battery charger only for specified batteries.
- When a rechargeable battery is charged for the first time or charged after a long period of disuse, battery life may be shorter than usual. Repeat discharging and recharging a few times. The battery life should return to normal.
- Disconnect the charger from the wall outlet as soon as the battery has been charged. Leaving it connected may result in reduced battery performance.
- The charger and a rechargeable battery may become warm while recharging, however this is normal and is not a malfunction.
- The charging time may vary depending on the battery condition.
- A rechargeable battery can be charged about 300 times.
- When the battery life of a fully charged rechargeable battery becomes about half the normal life, you may need to replace the battery with a new one.

For the customers in the U.S.A. and Canada

DISPOSAL OF NICKEL METAL HYDRIDE BATTERY.

NICKEL METAL HYDRIDE BATTERY. DISPOSE OF PROPERLY.

You can return your unwanted nickel metal hydride batteries to your nearest Sony Service Center or Factory Service Center.

Note: In some areas the disposal of nickel metal hydride batteries in household or business trash may be prohibited.

For the Sony Service Center nearest you call 1-800-222-SONY (United States only)

For the Sony Factory Service Center nearest you call

416-499-SONY (Canada only)

Caution: Do not handle damaged or leaking nickel metal hydride battery.

Troubleshooting

If you experience any of the following difficulties while using Network Walkman, use this troubleshooting guide to help you remedy the problem. Should any problem persist, consult your nearest Sony dealer. For trouble concerning operations while connecting with your computer, please refer to the supplied software's online help "Troubleshooting" contents, too.

To reset the player

If Network Walkman does not operate normally or if there is no sound, even after checking the troubleshooting guide below, remove the battery, then re-insert it.

What happened ?

On playback

Symptom	Cause/Remedy
There is no sound.	→ Adjust the volume (page 11). → Connect the headphones securely to the headphones jack.
The volume does not increase.	→ Cancel the AVLS function (page 14).
Sound is distorted.	→ Record with a higher bps value (page 32).
There is no sound from the right channel of the headphones.	→ Make sure that the headphones plug is connected securely.
Playback has stopped suddenly.	→ The battery is exhausted. You need to change it (page 8). → Release and reinsert the "Memory Stick" a few times to clean the terminals.
Cannot playback audio data with date limits.	→ You must set the date in the menu (page 18). → The date has expired.

On the display window

Symptom	Cause/Remedy
The backlight is off.	→ Set the LIGHT setting to ON (turns on during operation) in the menu (page 18).
"□" appears instead of the album title.	→ Use the OpenMG Jukebox to rename the title with characters which can be displayed on the player.

Troubleshooting (continued)

On charging

Symptom	Cause/Remedy
The battery does not last even when recharged.	<ul style="list-style-type: none">→ If you use the player where the temperature is below 0°C (32°F), the battery does not function.→ You need to replace the battery. Please contact your nearest Sony dealer.
Charging stops just after connecting the supplied battery charger.	<ul style="list-style-type: none">→ The battery is full. (If the charging stops even when the battery is low, this may be due to a problem with the battery life. Please contact your nearest Sony dealer.)

On the connection with the computer

Symptom	Cause/Remedy
“CONNECT” does not appear in the display window when connecting to the computer with the supplied USB cable.	<ul style="list-style-type: none">→ Please wait for the authentication of the OpenMG Jukebox (page 31) to be finished.→ If another software is active on your computer, wait for a while, then reconnect the USB cable. If the problem persists, disconnect the USB cable, restart your computer, then connect the USB cable to your computer again.→ Make sure the USB cable is correctly connected.
The computer does not identify the player when it is connected to the computer.	<ul style="list-style-type: none">→ Make sure the USB cable is correctly connected (page 9).→ Install driver only. For details, refer to the OpenMG Jukebox operating instructions.
There are only a few songs I can Check-out. (The recordable time is short.)	<ul style="list-style-type: none">→ If there is data other than audio files in the “Memory Stick,” copy them to your computer to free memory on the “Memory Stick.”
After connecting to the computer, the drive appears but there is nothing inside.	<ul style="list-style-type: none">→ Make sure the “Memory Stick” is inserted and reconnect the player to your computer. Disconnect the USB cable and put in the battery, then check the display. If the error message is displayed, there may be a problem with the “Memory Stick.” Follow the on-screen instructions to solve the problem.
The computer/player does not operate normally when connected.	<ul style="list-style-type: none">→ If you are connecting both devices with a USB hub or a USB extension cable, normal operation is not guaranteed. Please use only the supplied USB cable.

Other

Symptom	Cause/Remedy
The buttons do not operate.	→ Make sure the HOLD switch is OFF (page 16). → You must recharge the battery (page 8).
There is no beep sound to indicate that operation has been accepted.	→ Set the BEEP setting to ON in the menu (page 17).
Cannot insert the "Memory Stick."	→ Make sure the "Memory Stick" is correctly inserted as shown on Network Walkman (page 9).
The current time is reset.	→ The battery is low and needs to be charged.
Cannot use a "Memory Stick" used on other devices.	→ Only "MagicGate Memory Stick" can be used with this player. → If the "Memory Stick" has been formatted using a computer, backup the files of the "Memory Stick" on your computer if necessary, and reformat the "Memory Stick" using this player (page 21).

Troubleshooting (continued)

Error messages

Follow the instructions below if an error message appears in the display.

Message	Meaning	Remedy
ACCESS	Accessing the "Memory Stick."	This is not an error. Please wait for access to be finished. Do not take out the "Memory Stick".
CANNOT PLAY	<ul style="list-style-type: none">• The player cannot playback certain contents of this "Memory Stick" due to a difference in format.• Check-out has been interrupted forcefully.	<ul style="list-style-type: none">• Remove and reinsert the battery, and then check the display on the screen.• If music data cannot be played back, you can erase it from the "Memory Stick." <p>For details on how to erase, refer to "To erase the abnormal data from the Memory Stick" (page 29).</p>
FILE ERROR	<ul style="list-style-type: none">• Cannot read the data.• The data is not normal.	<ul style="list-style-type: none">• Remove and reinsert the battery, and then make sure displays on the screen.• You need to Check-in data you are able to Check-in into your computer, then format the "Memory Stick" using this player. (See "To delete abnormal data from the Memory Stick" on page 29.)
FORMAT ERR	The inserted "Memory Stick" contains a data format which is not supported by Network Walkman. (For example, if you format the "Memory Stick" using the computer.)	You must format the "Memory Stick" following the instructions on page 21. (You must format the "Memory Stick" using this player. If you format the "Memory Stick" using the computer, you may Check-in/out, but you cannot playback using this player.)
HOLD	The HOLD switch is ON, and no operating buttons are available.	This is not an error. Switch the HOLD switch to OFF before operating the buttons.
EXPIRED	<ul style="list-style-type: none">• The data's playback date has expired.• The current date has not been set to playback data with date limits.• Plays back songs beyond the playback restriction supported by Network Walkman.	<ul style="list-style-type: none">• You need to set the current date to playback data with date limits (page 18).• If there is data in a different format, you must delete that data from the "Memory Stick". (See "To delete abnormal data from the Memory Stick," on page 29.)
MS LOCKED	The erasure prevention switch of the "Memory Stick" is on LOCK.	Switch the erasure prevention switch to OFF when connecting to your computer or formatting a "Memory Stick."
LOW BATT	The battery is low, and needs to be charged.	You must charge the battery.
ERROR	A malfunction is detected.	First, remove and reinsert the battery. If you have any questions or problems concerning your Network Walkman, please consult your nearest Sony dealer.
NO AUDIO	<ul style="list-style-type: none">• There is no music data in "MagicGate Memory Stick."• The "Memory Stick" is not "MagicGate Memory Stick."	Check that "MagicGate Memory Stick" is inserted. If there is no music data in "MagicGate Memory Stick," use the OpenMG Jukebox to Check-out music items.

Message	Meaning	Remedy
NO DATA	There are no tracks inside "MagicGate Memory Stick."	Use the OpenMG Jukebox to Check-out music items.
NO STICK	There is no "Memory Stick" inserted.	Insert a "Memory Stick."
CONNECT	The player is connected to the computer.	This is not an error. You can operate using the OpenMG Jukebox software, but you cannot operate the controls on the player.
STICK ERROR	You cannot access the "Memory Stick," or the data inside the "Memory Stick" or the player itself is not normal.	<ul style="list-style-type: none"> • Remove and reinsert the battery, and then make sure displays on the screen. • Eject and reinsert the "Memory Stick" a few times. If this does not solve the problem, Check-in data items into the computer, and then format the "Memory Stick" using this player. (Refer to the instructions in "To delete the abnormal data from the Memory Stick" below for details.) <p>If the problem persists, bring both the player and the "Memory Stick" to your nearest Sony dealer.</p>
MG ERROR	An unauthorized distribution file is detected for copyright protection.	<ul style="list-style-type: none"> • Remove and reinsert the battery, then check the display on the screen. • First, check-in the Check-in data available to your computer, then format the "Memory Stick" with Network Walkman. <p>Refer to the instructions in "To delete the abnormal data from the Memory Stick" below for details.</p>

To delete abnormal data from the "Memory Stick"

If "CANNOT PLAY," "EXPIRED" "FILE ERROR," "STICK ERROR" "MG ERROR" appears in the display window, there is abnormal data in the "Memory Stick."

Please follow the instructions below to delete abnormal data (data you cannot playback).

- 1 Connect Network Walkman to your computer, and start the "OpenMG Jukebox."
- 2 If the cause of the abnormal data is clear (data of which the playback date limits have expired, etc.), erase the data from the Portable Player window of the "OpenMG Jukebox."
- 3 If the problem persists, click the  button on the OpenMG Jukebox to Check-in all data you are able to Check-in.
- 4 Disconnect the player from the computer and then format the "Memory Stick" using the menu (page 21).

Note

If you format the "Memory Stick," data that has been recorded using other devices will be deleted, too. If there are other data in the "Memory Stick," check the data contents using a compatible equipment before formatting the "Memory Stick." Refer to the OpenMG Jukebox Help files.

Specifications

Recording time (when using the supplied 64MB "MagicGate Memory Stick")

Approx. 60 min. (132kbps)
Approx. 80 min. (105kbps)
Approx. 120 min. (66kbps)

Sampling frequency response

44.1kHz

Recording format

ATRAC3

Frequency response

20 to 20,000 Hz (single signal measurement)

Output

Headphone/earphone: stereo mini-jack

Signal-to-noise ratio (S/N)

More than 80dB (excluding 66 kbps)

Dynamic range

More than 85dB (excluding 66 kbps)

Operating temperature

5°C to 35°C (-41°F to 95°F)

Power source

- DC IN 1.2V (gum type, secondary battery Ni-MH (NH-14WM))
- Power for USB (supplies from the computer through supplied USB cable)

Battery life

Approx. 10 hours (back-to-back playback)

Dimensions (approx.)

36 × 81.4 × 14.1 mm (1 7/16 × 3 1/4 × 9/16 inches)
(w/h/d, projecting parts not included)

Mass (approx.)

67g (2.4 oz) (includes "Memory Stick," battery NH-14WM)

Supplied accessories

64MB "MagicGate Memory Stick" (1)
Rechargeable battery (1)
Battery charger (1)
AC plug adaptor (1) (Except U.S.A, Europe, Hong Kong, Korea, and Australia model)
Earphones (1)
USB cable (1)
"Memory Stick" storage case (1)
Rechargeable battery carrying case (1)
Carrying pouch (1) (Except for U.S.A model)
Key ring (1)
CD-ROM (OpenMG Jukebox installation disc) (1)
NW-MS9 Operating Instructions (1)
OpenMG Jukebox Operating Instructions (1)

Optional accessories

"MagicGate Memory Stick" MSG-32A (32MB)
MSG-64A (64MB)

Design and specifications are subject to change without notice.

Glossary

MagicGate

Copyright protection technology that consists of authentication and encryption technology. Authentication ensures that protected content is transferred only between compliant devices and media, and that protected content is recorded and transferred in an encrypted format to prevent unauthorized copying or playback.

Note

MAGIC GATE is terminology denoting the copyright protection system developed by Sony. It does not guarantee conversion among other media.

“MagicGate Memory Stick”

A compact IC recording media “Memory Stick” equipped with “MagicGate” copyright protection technology. You can record or play data, such as music, that requires copyright protection only by using a “MagicGate Memory Stick” with “MagicGate” compatible equipment (e.g., Network Walkman).

“MagicGate Memory Stick” can be used to record any other kind of digital data with any other “Memory Stick” compatible equipment.

“MagicGate Memory Stick” is distinguished by the “MG” and “MAGIC GATE” logos.

“Memory Stick”

“Memory Stick” is a portable and compact Integrated Circuit recording medium. There are two types of “Memory Stick”: “MagicGate Memory Stick” equipped with “MagicGate” copyright protection technology and a normal “Memory Stick” not equipped with the copyright protection technology. You can record image files, audio files, and sound files using “Memory Stick” compatible audio visual devices, or record data from the computer. Data with different formats can be stored in the same “Memory Stick.” (Please refer to the instruction manuals that come with the devices to check which format the equipment is able to read.)

For example, you can store image files in the space available on “MagicGate Memory Stick” using the respective equipment even if there are already audio files in “MagicGate Memory Stick.”

OpenMG

Copyright protection technology that securely manages music content from the EMD/Audio CD on a personal computer. Application software that is installed on the computer encrypts the digital music content when recording on the hard drive. This allows you to enjoy music content on the computer, but prevents unauthorized transmission of this content across a network (or elsewhere). This PC copyright protection complies with “MagicGate,” and allows you to transfer digital music content from a PC’s hard drive to a compliant device.

ATRAC3

ATRAC3, which stands for Adaptive Transform Acoustic Coding3, is audio compression technology that satisfies the demand for high sound quality and high compression rates.

The ATRAC3 compression rate is approximately 10 times higher than that of the Audio CD, resulting an increased data capacity for the media.

Glossary (continued)

SDMI

SDMI which stands for Secure Digital Music Initiative, is a forum that consists of over 130 companies in the fields of recorded audio content, computers, and consumer electronics, dedicated to developing an integrated method of copyright protection technology that can be used worldwide.

SDMI is working to create a framework for preventing improper usage of audio files and to promote legal music distribution services. The copyright protection technologies “OpenMG” and “MagicGate” are based upon the SDMI standard.

“Check-in/Check-out”

Check-out is to transfer music files from a personal computer to an external device/media (such as Network Walkman). Returning checked-out music files to the same computer is to check-in. (You cannot move checked-out music files to another computer.)

You can check-out a music file, check it back in, and then check it out again an infinite number of times. The SDMI rules provide that up to four copies of a music file can be checked-out at one time. OpenMG employs a method whereby three copies of a song can be checked-out simultaneously, while the fourth copy is maintained as a “master” on your PC. If three copies of the same song are checked-out at a given time, one copy of the song needs to be checked-in to the computer in order to create an additional check-out.

Bit rate

Indicates the data amount per second. The rate is reflected in bps (bit per second).

In OpenMG Jukebox, the bit rate for recording an audio CD or converting MP3 and WAV format audio files into ATRAC3 format can be chosen from 132 kbps/105kbps/66kbps. 105 kbps means 105000 bits of information per second. If the bit rate is large, that means a large amount of information is used to play music. Comparing music of the same format, a 105 kbps data offers better sound quality than 66 kbps data, and 132 kbps data offers better sound quality than 105 kbps data. However, audio files in formats such as MP3 have different encoding methods, and thus sound quality cannot be determined by simply comparing the bit rate.

Looking at the controls

Network Walkman

(front)

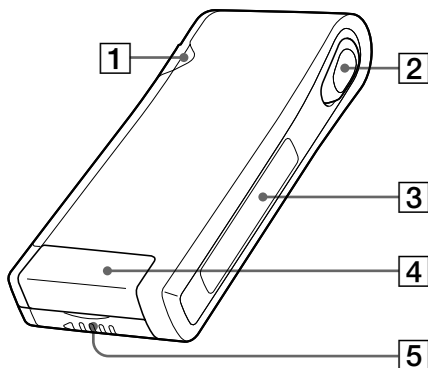

- 1 Access lamp (page 9)
- 2 Seesaw key (page 11-14, 16-22)
- 3 Display (page 12, 15)
- 4 Memory Stick slot (page 9, 11)
- 5 Battery compartment (page 8)

(rear)

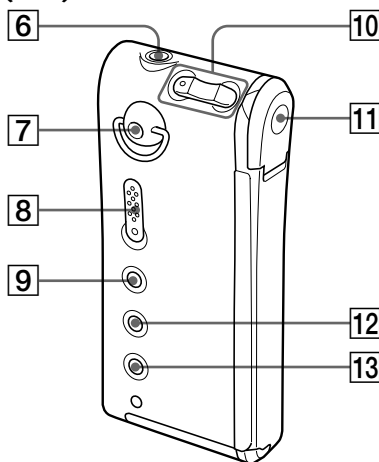

- 6 (Headphones/earphones) jack (page 11)
- 7 Hole for attaching the key ring or strap (The strap is not supplied)
- 8 HOLD switch (page 16)
- 9 MEGA BASS/AVLS button (page 18)
- 10 VOLUME +/- buttons (page 11, 16)
- 11 Dedicated USB jack (page 9)
- 12 MENU button (page 13, 16-22)
- 13 DISPLAY button (page 12, 15)

Other Information

Display

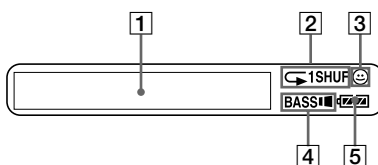

- 1 Text/graphic information display (page 15)
- 2 Playback mode indication (page 13)
- 3 AVLS indication (page 14)
- 4 MEGA BASS indication (page 14)
- 5 Battery remain indication (page 8)

Index

A

Access lamp	9
actual track	12
artist name	15
ATRAC3	31
AVLS	14

B

Backlight	18
Battery	8
Battery charge lamp	8
Battery remain indicator	8
BEEP	17
beginning of the track	12
Bit rate	15, 32

C

CD (compact disc)	4
CD-ROM	7
charging	8
Check-in	32
Check-out	9, 32
computer	4, 9

D

DATE-TIME	18
display	12, 15
DISPLAY button	15
display mode	15
download	4

E

EMD services	4
ERASE	20
erasure prevention switch	23
earphones	7

F

FORMAT	21
formatting	6, 21

G

go backward	12
go forward	12

H

headphones/earphones	11
Hifi Folder	6
HOLD	16
HOLD switch	16

I

Internet (EMD services)	4
-------------------------	---

L

LIGHT	18
listen to music	11
LOW BATT	8, 28

M

MEGA BASS	14
MagicGate	31
“MagicGate Memory Stick”	4, 5, 7, 31
“Memory Stick”	5, 23, 31
insert	9
remove	12
Menu	22
MENU button	13, 16-22

O

OpenMG	4, 31
OpenMG Jukebox software	9

P

playback	11
Preset volume	16
previous tracks	12

R

REPEAT	13
RETURN	22

S

SDMI	31
Serial Number	7
set the current data and time	18
song title	15
spectrum analyzer	15
succeeding tracks	12
supplied accessories	7

T

TITLE	15
transferring	
to the “Memory Stick”	9
troubleshooting	25

U

USB cable	7, 9
-----------	------

V

volume	11, 16
--------	--------

W

WAV format	4
Windows Explorer	6

<http://www.world.sony.com/>