



Desktop Computer

# PCV-RS600 Series Quick Start

**SONY**<sup>®</sup>

---

## Notice

© 2004 Sony Electronics Inc. Reproduction in whole or in part without written permission is prohibited. All rights reserved. This manual and the software described herein, in whole or in part, may not be reproduced, translated, or reduced to any machine-readable form without prior written approval.

SONY ELECTRONICS INC. PROVIDES NO WARRANTY WITH REGARD TO THIS MANUAL, THE SOFTWARE, OR OTHER INFORMATION CONTAINED HEREIN AND HEREBY EXPRESSLY DISCLAIMS ANY IMPLIED WARRANTIES OF MERCHANTABILITY OR FITNESS FOR ANY PARTICULAR PURPOSE WITH REGARD TO THIS MANUAL, THE SOFTWARE, OR SUCH OTHER INFORMATION. IN NO EVENT SHALL SONY ELECTRONICS INC. BE LIABLE FOR ANY INCIDENTAL, CONSEQUENTIAL, OR SPECIAL DAMAGES, WHETHER BASED ON TORT, CONTRACT, OR OTHERWISE, ARISING OUT OF OR IN CONNECTION WITH THIS MANUAL, THE SOFTWARE, OR OTHER INFORMATION CONTAINED HEREIN OR THE USE THEREOF.

SONY CANNOT WARRANT THAT THE FUNCTIONS DESCRIBED IN THIS GUIDE WILL BE UNINTERRUPTED OR ERROR-FREE. SONY ALSO ASSUMES NO RESPONSIBILITY, AND SHALL NOT BE LIABLE FOR ANY DAMAGES TO, OR VIRUSES THAT MAY INFECT, YOUR COMPUTER EQUIPMENT, OR OTHER PROPERTY ON ACCOUNT OF YOUR ACCESS TO, USE OF, OR BROWSING IN ANY DESCRIBED WEB SITE, OR YOUR DOWNLOADING OF ANY MATERIALS, DATA, TEXT, IMAGES, VIDEO, OR AUDIO FROM ANY DESCRIBED WEB SITE. WEB SITE INFORMATION IS OBTAINED FROM VARIOUS SOURCES AND MAY BE INACCURATE. COPIES OF COPYRIGHTED INFORMATION MAY ONLY BE MADE FOR LEGALLY PERMISSIBLE PURPOSES.

Sony Electronics Inc. reserves the right to make any modification to this manual or the information contained herein at any time without notice. The software described herein is governed by the terms of a separate user license agreement.

This product contains software owned by Sony and licensed by third parties. Use of such software is subject to the terms and conditions of license agreements enclosed with this product. Some of the software may not be transported or used outside the United States. Software specifications are subject to change without notice and may not necessarily be identical to current retail versions.

Certain product(s) included with this computer may include features such as copy protection and content management technology. USE OF THE SOFTWARE PRODUCT(S) REQUIRES AGREEMENT TO APPLICABLE END USER AGREEMENTS AND FULL COMPLIANCE WITH APPLICABLE PRODUCT ACTIVATION PROCEDURES. Product activation procedures and privacy policies will be detailed during initial launch of the software product(s), or upon certain reinstallations of the software product(s), or reconfigurations of the computer, and may be completed by Internet or telephone (toll charges may apply).

Updates and additions to software may require an additional charge. Subscriptions to online service providers may require a fee and credit card information. Financial services may require prior arrangements with participating financial institutions.

---

**Important information for Canadian customers:** Your new VAIO® computer includes certain software versions or upgrades, and Internet services or offers that are available to U.S. customers only.

Sony, VAIO, the VAIO logo, VAIO Digital Studio, VAIO Media, VAIO Media Music Server, VAIO Media Photo Server, VAIO Media Video Server, Click to DVD, CLIE, DVgate Plus, Handycam, MagicGate, Memory Stick, the Memory Stick logo, OpenMG, MICROMV, SonicStage, PictureGear, ImageStation, ATRAC3, and i.LINK, are trademarks or registered trademarks of Sony.

Intel and Pentium are trademarks or registered trademarks of the Intel Corporation. Microsoft, Windows, and the Windows logo, are trademarks or registered trademarks of Microsoft Corporation. PS/2 is a registered trademark of IBM Corporation.

All other trademarks are trademarks or registered trademarks of their respective owners.

	As an ENERGY STAR® Partner, Sony Corporation has determined that this product meets the ENERGY STAR® guidelines for energy efficiency.
---	--

The International ENERGY STAR® Office Equipment Program is an international program that promotes energy saving through the use of computers and other office equipment. The program backs the development and dissemination of products with functions that effectively reduce energy consumption. It is an open system in which business proprietors can participate voluntarily. The targeted products are office equipment such as computers, displays, printers, facsimiles and copiers. Their standards and logos are uniform among participating nations. ENERGY STAR is a U.S. registered trademark of the Environmental Protection Agency.

### ***Owner's Record***

The model number and serial number are located inside the lower front panel of your Sony VAIO® computer. Record the model and serial number in the space provided here, and keep in a secure location. Refer to the model and serial numbers when you call your Sony Service Center.

Model Number:	
Serial Number:	

---

## **Safety Information and Caution**

Your computer's installed optical drives may vary, depending on the system configuration you have purchased. See the online specification sheet for details on your installed optical drives. For questions regarding your product or for the Sony Service Center nearest you, visit the Sony Online Support Web site at <http://www.sony.com/pcsupport>.

- To prevent fire or shock hazard, do not expose your desktop to rain or moisture.
- To avoid electrical shock, do not open the cabinet. Refer servicing to qualified personnel only.
- Never install modem or telephone wiring during a lightning storm.
- Never install telephone jacks in wet locations unless the jack is specifically designed for wet locations.
- Never touch uninsulated telephone wire or terminals unless the telephone line has been disconnected at the network interface.
- Use caution when installing or modifying telephone lines.
- Avoid using the modem during an electrical storm.
- Do not use the modem or a telephone to report a gas leak in the vicinity of the leak.
- The socket outlet shall be installed near the equipment and shall be easily accessible.



**To change the backup battery, please contact your nearest Sony Service Center.**



**Caution: The use of optical instruments with this product will increase eye hazard. As the laser beam used in this product is harmful to the eyes, do not attempt to disassemble the drive cabinet. Refer servicing to qualified personnel only.**



**Danger: Visible and invisible laser radiation when open. Avoid direct exposure to beam.**



**For DVD±RW/DVD-RW/DVD-ROM: Danger—Visible and invisible laser radiation when open. Avoid direct exposure to beam.**



**For CD-RW/CD-ROM: Danger—Invisible laser radiation when open. Avoid direct exposure to beam.**



**Caution: For ADSL and V.90 modem models; to reduce the risk of fire, use only No. 26 AWG or larger telecommunication line cord.**

- 
- Pour prévenir tout risque d'incendie ou d'électrocution, garder cet appareil à l'abri de la pluie et de l'humidité.
  - Pour prévenir tout risque d'électrocution, ne pas ouvrir le châssis de cet appareil et ne confier son entretien qu'à une personne qualifiée.
  - Ne jamais effectuer l'installation de fil modem ou téléphone durant un orage électrique.
  - Ne jamais effectuer l'installation d'une prise téléphonique dans un endroit mouillé à moins que la prise soit conçue à cet effet.
  - Ne jamais toucher un fil téléphonique à découvert ou un terminal à moins que la ligne téléphonique n'ait été débranché de l'interface réseau.
  - Soyez très prudent lorsque vous installez ou modifiez les lignes téléphoniques.
  - Évitez d'utiliser le modem durant un orage électrique.
  - N'utilisez pas le modem ni le téléphone pour prévenir d'une fuite de gaz vous êtes près de la fuite.
  - L'appareil doit être le plus près possible d'une prise murale pour en faciliter l'accès.



**Pour changer la pile de recharge, veuillez contacter votre centre de service Sony le plus près.**



**Avertissement: L'utilisation d'instruments optiques avec ce produit augmente les risques pour les yeux. Puisque le faisceau laser utilisé dans ce produit est dommageable pour les yeux, ne tentez pas de désassembler le boîtier. Adressez-vous à un agent de service qualifié.**



**Danger: Radiation laser visible et invisible si ouvert. Évitez l'exposition directe au faisceau.**



**Pour les DVD±RW/DVD-RW/DVD-ROM: Danger—Radiation laser visible et invisible si ouvert. Évitez l'exposition directe au faisceau.**



**Pour les CD-RW/CD-ROM: Danger—Radiation laser invisible si ouvert. Évitez l'exposition directe au faisceau.**



**Attention: Pour ADSL et V.90 modele modem; afin de réduire les risques d'incendie, n'utilisez qu'un cordon de communication NO. 26 AWG ou plus gros.**

---

## **Regulatory Information**

If you have questions about this product, write to Sony Customer Information Service Center at 12451 Gateway Blvd., Ft. Myers, FL 33913, USA, or visit Sony Customer Service on the Sony Online Support Web site at <http://www.sony.com/pcsupport>.

### **Declaration of Conformity**

Trade Name:	SONY
Model No.:	PCV-2252 PCV-2253
Responsible Party:	Sony Electronics Inc.
Address:	16450 W. Bernardo Drive San Diego, CA 92127, USA
Telephone:	858-942-2230

This phone number is for FCC-related matters only.

This device complies with Part 15 of the FCC rules. Operation is subject to the following two conditions:

- (1) This device may not cause harmful interference, and
- (2) this device must accept any interference received, including interference that may cause undesired operation.

### **Model No.: PCVA-IMB5A (For models equipped with Giga Pocket features)**

This device complies with Part 15 of the FCC rules. Operation is subject to the following two conditions:

- (1) This device may not cause harmful interference, and
- (2) this device must accept any interference received, including interference that may cause undesired operation.

---

This equipment has been tested and found to comply with the limits for a Class B digital device, pursuant to Part 15 of the FCC Rules. These limits are designed to provide reasonable protection against harmful interference in a residential installation. This equipment generates, uses, and can radiate radio frequency energy and, if not installed and used in accordance with the instructions, may cause harmful interference to radio communications. However, there is no guarantee that interference will not occur in a particular installation. If this equipment does cause harmful interference to radio or television reception, which can be determined by turning the equipment off and on, the user is encouraged to try to correct the interference by one or more of the following measures:

- 
- Reorient or relocate the receiving antenna.
  - Increase the separation between the equipment and the receiver.
  - Connect the equipment into an outlet on a circuit different from that to which the receiver is connected.
  - Consult the dealer or an experienced radio/TV technician for help.

You are cautioned that any changes or modifications not expressly approved in this manual could void your authority to operate this equipment.

Only peripherals (computer input/output devices, terminals, printers, etc.) that comply with FCC Class B limits may be attached to this computer product. Operation with noncompliant peripherals is likely to result in interference to radio and television reception.

All cables used to connect peripherals must be shielded and grounded. Operation with cables, connected to peripherals, that are not shielded and grounded, may result in interference to radio and television reception.

## ***FCC Part 68***

This equipment complies with Part 68 of the FCC rules and the requirements adopted by the ACTA. On the modem card is a label that contains, among other information, a product identifier in the format US:AAAEQ##TXXXX. If requested, this number must be provided to the telephone company.

This modem uses the USOC RJ-11 telephone jack.

A telephone plug and jack used to connect this equipment to the premises wiring and telephone network must comply with the applicable FCC Part 68 rules and requirements adopted by the ACTA. The REN is used to determine the quantity of devices which may be connected to the telephone line.

Excessive RENs on the telephone line may result in the devices not ringing in response to an incoming call. In most, but not all areas, the sum of the RENs should not exceed five (5.0). To be certain of the number of devices that may be connected to the line, as determined by the total RENs, contact the telephone company. For products approved after July 23, 2001, the REN for this product is part of the product identifier that has the format US:AAAEQ##TXXXX. The digits represented by ## are the REN without a decimal point (e.g. 03 is a REN of 0.3). For earlier products, the REN is separately shown on the label.

If this equipment causes harm to the telephone network, the telephone company will notify you in advance that temporary discontinuance of service may be required. But if advance notice is not practical, the telephone company will notify the customer as soon as possible. Also, you will be advised of your right to file a complaint with the FCC if you believe it is necessary.

The telephone company may make changes in its facilities, equipment, operations or procedures that could affect the operations of the equipment. If this happens, the telephone company will provide advance notice in order for you to make the necessary modifications in order to maintain uninterrupted service.

---

If trouble is experienced with this equipment, for repair or warranty information, please contact the Sony Customer Information Service Center at 1-888-4-SONY-PC (1-888-476-6972), or write to the Sony Customer Information Center, 12451 Gateway Blvd., Fort Myers, FL 33913, or find Sony Customer Service on the Web at <http://www.sony.com/pcsupport>. If this equipment is causing harm to the telephone network, the telephone company may request that you disconnect the equipment from the network until the problem is resolved.

Repair of this equipment should be made only by a Sony Service Center or Sony authorized agent. For the Sony Service Center nearest you, call 1-888-4-SONY-PC (1-888-476-6972), or visit the Sony Online Support Web site at <http://www.sony.com/pcsupport>.

Connection to Party Line Service is subject to state tariffs. Contact the state public utility commission, public service commission, or corporation commission for information.

If your home has specially wired alarm equipment connected to the telephone line, ensure the installation of this equipment does not disable your alarm equipment. If you have questions about what will disable alarm equipment, consult your telephone company or a qualified installer.

Please use a surge arrester against electrical surges.

### ***Telephone Consumer Protection Act of 1991 (United States)***

The Telephone Consumer Protection Act of 1991 makes it unlawful for any person to use a computer or other electronic device, including FAX machines, to send any message unless such message clearly contains, in a margin at the top or bottom of each transmitted page or on the first page of the transmission, the date and time it is sent and an identification of the business, other entity, or individual sending the message, and the telephone number of the sending machine or such business, other entity, or individual. (The telephone number provided may not be a 900 number or any other number for which charges exceed local or long distance transmission charges.)

In order to program this information into your facsimile machine, see your fax software documentation.

### ***Telephone Consumer Guidelines (Canada)***

Please refer to your telephone directory under 'Privacy Issues' and/or 'Terms of Service.' For more detailed information, please contact:

**CRTC**

**Terrasses de la Chaudière**

**Tour centrale 1 promenade du Portage**

**5 étage Hull PQ K1A 0N2.**

This Class B digital apparatus complies with Canadian ICES-003.

Cet appareil numérique de la classe B est conforme à la norme NMB-003 du Canada.

**Model No.: PCVA-IMB5A (For models equipped with Giga Pocket features)**

Supplementary Television Broadcasting Receiving Apparatus - Appareils supplémentaires de réception de télévision, Canada.



---

## **Disposal of Lithium Battery**

You can return your unwanted lithium batteries to your nearest Sony Service Center or Factory Service Center.



In some areas the disposal of lithium batteries in household or business trash may be prohibited.

For the location of the Sony Service Center nearest you, visit the Sony Online Support Web site at <http://www.sony.com/pcsupport>.



**Do not handle damaged or leaking lithium batteries.**

**Ne pas manipuler les batteries au lithium qui fuient ou sont endommagées.**



**Danger of explosion if battery is incorrectly replaced. Replace only with the same or equivalent type recommended by the manufacturer. Discard used batteries according to the manufacturer's instructions.**

**Une batterie non conforme présente un danger d'explosion. La remplacer seulement par une batterie identique ou de type équivalent recommandé par le fabricant. Évacuer les batteries usées selon les directives du fabricant.**



**The battery pack used in this device may present a fire or chemical burn hazard if mistreated. Do not disassemble, heat above 212° F (100° C), or incinerate. Dispose of used battery promptly. Keep away from children.**

**La manutention incorrecte du module de batterie de cet appareil présente un risque d'incendie ou de brûlures chimiques. Ne pas démonter, incinérer ou exposer à une température de plus de 100°C. Évacuer promptement la batterie usée. Garder hors de portée des enfants.**

---

## ***Industry Canada Notice***

This equipment meets the applicable Industry Canada technical specifications.

The Ringer Equivalence Number (REN) is an indication of the maximum number of devices allowed to be connected to a telephone interface. The termination on an interface may consist of any combination of devices subject only to the requirement that the sum of the RENs of all the devices does not exceed 5.

## ***Avis De L'industrie Canada***

Le présent matériel est conforme aux spécifications techniques applicables d'Industrie Canada.

L'indice d'équivalence de la sonnerie (IES) sert à indiquer le nombre maximal de terminaux qui peuvent être raccordés à une interface téléphonique. La terminaison d'une interface peut consister en une combinaison quelconque de dispositifs, à la seule condition que la somme d'indices d'équivalence de la sonnerie de tous les dispositifs n'excède pas 5.

## ***Macrovision License***

**(For models equipped with ATI® RADEON™ 9200 technology.)**

This product incorporates copyright protection technology that is protected by U.S. patents and other intellectual property rights. Use of this copyright protection technology must be authorized by Macrovision, and is intended for home and other limited viewing uses only, unless otherwise authorized by Macrovision. Reverse engineering or disassembly is prohibited.

## ***Licence Macrovision***

**(Pour les modèles distribués avec la technologie ATI® RADEON™ 9200.)**

Ce produit intègre une technologie de protection de la loi sur le droits de propriété intellectuelle couverts par la législation américaine. L'utilisation de cette technologie doit être autorisée par Macrovision. Elle est uniquement destinée à un usage privé et à d'autres fins de visualisation limitée, sauf autorisation contraire de la part de Macrovision. Tout désossage ou désassemblage est formellement interdit.

# Contents

<b>Getting Started .....</b>	<b>13</b>
Unpacking Your Computer .....	14
<b>Locating Controls And Ports .....</b>	<b>17</b>
About the Front Panel .....	18
About the Back Panel .....	21
About the Keyboard .....	24
About the Remote Control .....	26
<b>Setting Up Your Computer .....</b>	<b>31</b>
Connecting a Display (Monitor) .....	32
Connecting the Speakers .....	33
Connecting the Keyboard and Mouse .....	34
Connecting the Telephone and Modem Cables.....	36
Connecting the Power Cords.....	38
Turning On Your Computer .....	39
Registering Your Computer .....	39
Turning Off Your Computer .....	40

**Troubleshooting.....41**

**Support Options.....43**

Immediate Help and Support ..... 43

Resources for Additional Help and Support ..... 44

# Getting Started

*Congratulations on your purchase of the Sony VAIO® computer! Your new, high-performance, multimedia computer combines state-of-the-art computer functionality with the latest audio, video and information technology features.*

## Unpacking Your Computer

Your computer may not be supplied with all of the accessories shown, depending on the system configuration purchased. For details on the accessories supplied with your computer, go to the Sony Online Support web site at <http://www.sony.com/pcsupport> to view the online specifications sheet.

 Your VAIO® computer is not supplied with System or Application Recovery CDs. Use the VAIO Recovery utility to recover your computer's operating system and preinstalled software.

### Computer and supplied accessories

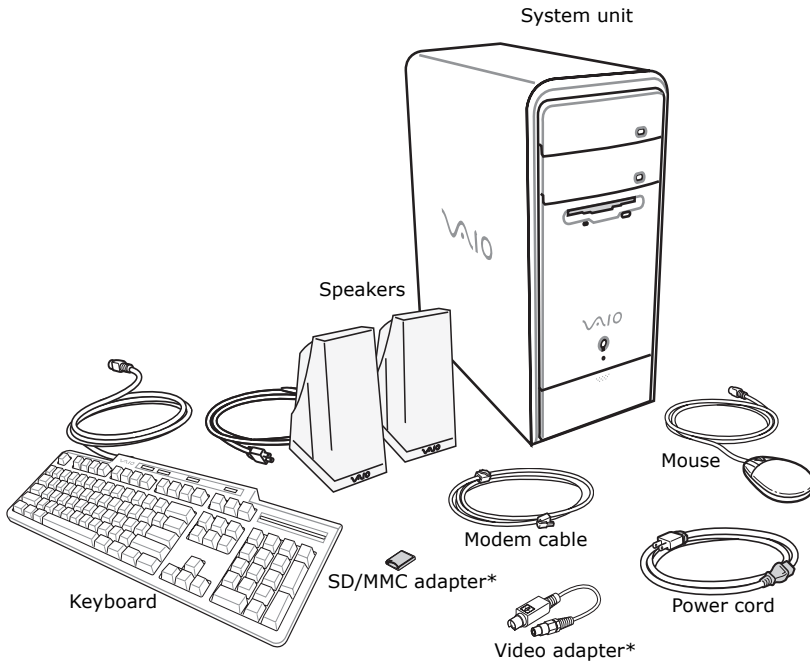

\* These items are not available with all VAIO® computer models. For details about your computer's supplied accessories, go to the Sony Online Support Web site and view your computer's specifications sheet.

***Giga Pocket Personal Video Recorder accessories  
(For models equipped with Giga Pocket features)***

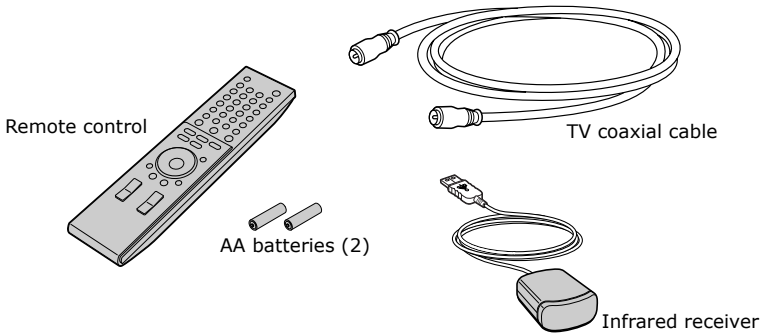

***Manuals***

- ❑ ***VAIO® Computer Quick Start*** — Provides basic information on setting up and registering your computer. The Quick Start also provides resources for technical support, safety guidelines, and owner’s information.

***Online documentation***

- ❑ ***VAIO® Computer User Guide*** — Contains information on the hardware and preinstalled software programs included with your system.

To access the online manual:

- 1 Click **Start** in the Windows taskbar, then click **Help and Support**.
  - 2 From the **VAIO Help And Support Center** menu, click **VAIO User Guide**.
- ❑ ***Specifications*** — This online specifications sheet describes the hardware and software configuration of your VAIO computer. Go to the Sony Online Support Web site at <http://www.sony.com/pcsupport> to view the specifications sheet.

- **VAIO® Software** — Provides specific information on the preinstalled software on your computer.

To access this online software information:

- 1 Click **Start** in the Windows® taskbar.
- 2 Click **Welcome to VAIO life**.

### ***Hard disk drive recovery***

Your computer is equipped with the VAIO Recovery Wizard, a utility program that recovers your computer's operating system and preinstalled software.

For more information about hard disk recovery:

- 1 Click **Start** in the Windows® taskbar, then click **Help and Support**.
- 2 From the **VAIO Help And Support Center** menu, click **VAIO Recovery Options**.

### ***Other***

A software library, containing the Microsoft® software and Sony® end-user license agreements.



# *Locating Controls And Ports*

*This section is intended to familiarize you with the controls, ports and jacks on your computer. Your computer may not be equipped with all of these hardware features, and the location of the controls, ports, and jacks may vary from the illustrations shown in this section. See the specifications sheet for your computer on the Sony Online Support Web site at <http://www.sony.com/pcsupport>.*

## About the Front Panel

The front panel of your VAIO® computer enables access to the optical and floppy disk drives. On certain models, the front panel also provides access to a Memory Stick® media slot, Giga Pocket® Personal Video Recorder features, SmartMedia™, CompactFlash®/Microdrive™ media card slot, Universal Serial Bus (USB) and i.LINK® ports that enable you to connect compatible peripheral devices. Your computer configuration may vary, depending on the model purchased. See the specifications sheet for your computer on the Sony Online Support Web site at <http://www.sony.com/pcsupport>.

### Front panel

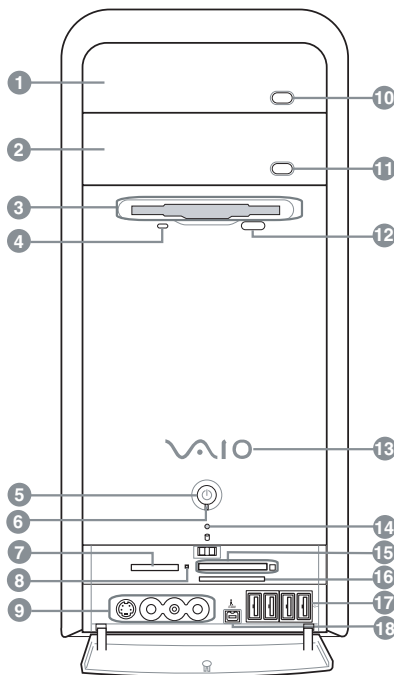

---

**1 Optical drive 1**

See the online specifications sheet for optical drive information.

---

**2 Optical drive 2\***

See the online specifications sheet for optical drive information.

- 
- 3 Floppy disk drive**  
Reads and writes data from and to a 3.5-inch floppy disk.
- 
- 4 Floppy disk drive access indicator**  
Light is green while reading and writing data from and to a floppy disk.
- 
- 5 Power button**  
The power button turns the computer on/off.
- 
- 6 Standby indicator**  
Light is amber when the computer is in Stand by mode.
- 
- 7 Memory Stick media slot and access indicator<sup>†</sup>**  
Reads and writes data from and to a Memory Stick® media. The access indicator is amber when reading or writing data to a Memory Stick media.
- 
- 8 Media access indicator<sup>‡</sup>**  
Light is amber when reading or writing data.
- 
- 9 S-video In jack<sup>†</sup>**  
Connection for an S-video cable (optional).  
**Composite video In jack<sup>†</sup>**  
Connection for a video cable (optional).  
**Composite audio L In jack<sup>†</sup>**  
Connection for an audio cable (optional).  
**Composite audio R In jack<sup>†</sup>**  
Connection for an audio cable (optional).
- 
- 10 Optical drive 1 eject button**  
Ejects a disc from Optical drive 1.
- 
- 11 Optical drive 2 eject button**  
Ejects a disc from Optical drive 2.
- 
- 12 Floppy disk eject button**  
Ejects a floppy disk.
-

- 
- 13 Power indicator (VAIO)**  
Light is blue when the computer is on. The light turns off when the computer is in Standby mode or turned off.
- 
- 14 Hard disk drive and optical disc drive access indicator**  
Light is amber while reading and writing data.
- 
- 15 CompactFlash/Microdrive media card slot<sup>†</sup>**  
Reads and writes data from and to CompactFlash® or Microdrive™ media.
- 
- 16 SmartMedia slot<sup>†</sup>**  
Reads and writes data from and to SmartMedia™ media.
- 
- 17 Universal Serial Bus (USB 2.0) ports<sup>\*\*</sup>**  
Connections for compatible high/full/low-speed USB devices.
- 
- 18 i.LINK 4-pin S400 port (IEEE 1394)**  
Connection for a compatible digital device.
- 

\* A second optical drive is optional on certain VAIO® computer models. See the specifications sheet for details on your computer's hardware configuration.

<sup>†</sup> Not available on all models. See your online specifications sheet for details.

<sup>‡</sup> On models equipped with these hardware features, the media access indicator light is amber when reading or writing data to the SmartMedia™ or CompactFlash®/Microdrive® slots.

\*\* The number of USB ports may vary depending on the model purchased.

 For your convenience, your computer includes USB and i.LINK ports on both the front and back panels. The 4-pin i.LINK port is located on the front panel and the 6-pin i.LINK port is located on the back.

## **Additional information**

Your computer is equipped with one or more optical disc drives that have a drive eject button on the drive door.

- After pushing the eject button, wait for the drive to stop reading the CD. It may take a few moments for the drive tray to eject.
- Gently push the drive tray in, when closing the optical drive door. Do not force the door or handle roughly.
- After closing the drive door, wait a few moments for the drive to begin reading the CD.

## About the Back Panel

The back panel of your computer contains the ports for supplied and optional accessories. The icons on the back panel locate and identify the ports and jacks on your computer.

 Your hardware configuration may vary based on the computer model purchased.

### Back panel

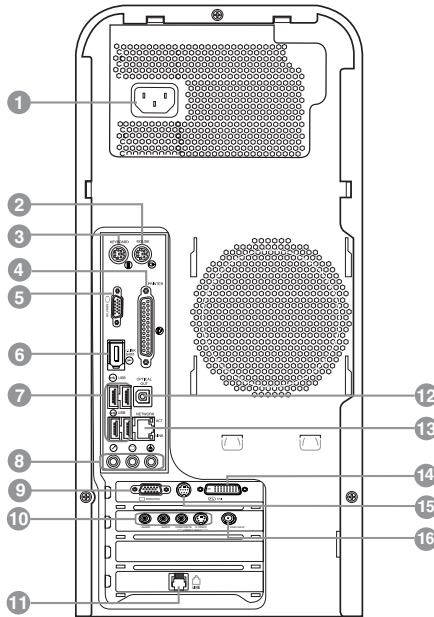

- 
- 1 AC Input port**  
Connection for the supplied power cord.
- 
- 2 Mouse port**  
Connection for a PS/2® mouse.
- 
- 3 Keyboard port**  
Connection for a PS/2® keyboard.
-

- 
- 4 Printer port**  
Connection for a parallel device, such as a printer or scanner.
- 
- 5 Monitor port\***  
Connection for a standard display.
- 
- 6 i.LINK 6-pin S400 port (IEEE 1394)**  
Connection for a compatible digital device.
- 
- 7 Universal Serial Bus (USB 2.0) ports (4)**  
Connections for compatible high/full/low-speed USB devices.
- 
- 8 Microphone jack**  
Connection for a microphone (optional).  
**Headphones jack**  
Connection for the supplied speakers or headphones (optional).  
**Line In jack**  
Connection for an audio device.
- 
- 9 Monitor port\***  
Connection for a standard display.
- 
- 10 Composite audio R In jack<sup>†</sup>**  
Connection for an audio cable (optional).  
**Composite audio L In jack<sup>†</sup>**  
Connection for an audio cable (optional).  
**Composite video In jack<sup>†</sup>**  
Connection for a video cable (optional).  
**S-video In jack<sup>†</sup>**  
Connection for an S-video cable (optional).
- 
- 11 Modem line jack**  
Connection for the modem cable (supplied) to the telephone wall jack.
- 
- 12 S/PDIF Optical Out port**  
Connection for a digital audio or optical device.
-

- 
- 13 Ethernet port**  
Connection for a 10BASE-T/100BASE-TX Ethernet interface.  
(The port marked with  $\frac{\square}{\square}$  (Network) is for LAN connections only.)
- 
- 14 Monitor (DVI) port\***  
Connection for a DVI monitor.
- 
- 15 TV Out (S-Video/video) jack†**  
Connection for an S-video cable (optional).
- 
- 16 VHF/UHF port†**  
Connection for a TV coaxial cable (supplied).
- 

\* This monitor port is not available on all models, and monitor port locations may vary. For details about your computer's hardware configuration, see the online specifications sheet.

† This feature is not available on all models. For details about your computer's hardware configuration, see the online specifications sheet.

 i.LINK is a trademark of Sony used only to designate that a product contains an IEEE 1394 connection. The i.LINK connection may vary, depending on the software applications, operating system, and compatible i.LINK devices. All products with an i.LINK connection may not communicate with each other.

Refer to the documentation that came with your compatible i.LINK device for information on operating conditions and proper connection. Before connecting compatible i.LINK devices to your system, such as an optical or hard disk drive, confirm their operating system compatibility and required operating conditions.

## About the Keyboard

Your VAIO® keyboard uses a standard key arrangement with additional keys that perform specific functions.

### VAIO Keyboard

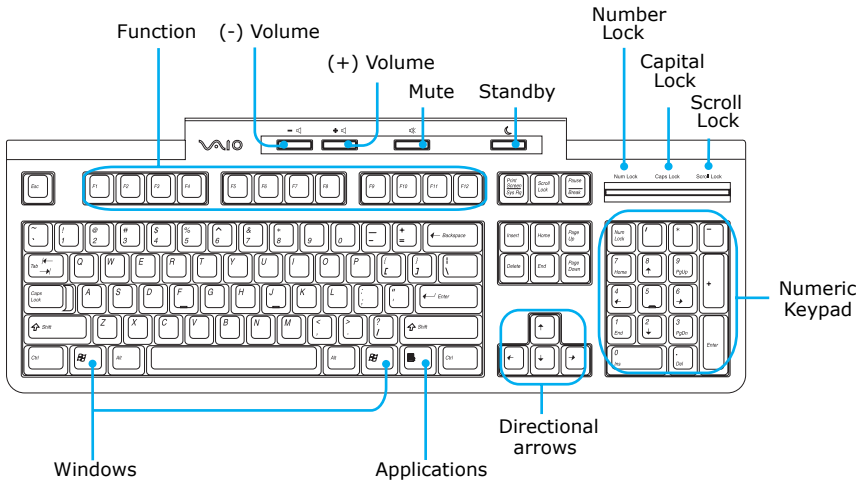

---

KEY	DESCRIPTION
-----	-------------

---

<b>Function</b>	The 12 function keys along the top of the keyboard are used to perform certain tasks. The task associated with each function key may vary from one application to the next.
-----------------	---

---

<b>Volume Control</b> =	Press a button to increase (+) or decrease (-) the volume of the speakers.
----------------------------	--



---

<b>Mute</b> 	Press the button to turn off the speaker sound. Press the Mute button again to restore sound.
-----------------	---

---



---

<b>KEY</b>	<b>DESCRIPTION</b>
<b>Standby</b> 	Press the button to place the computer in Standby mode. Press the Power button or any key briefly, to resume normal operation.
<b>Numeric keypad</b>	Use the numeric keypad area to type numbers or to perform basic math calculations. Press the Num Lock key to activate the numeric keypad. (The Num Lock indicator lights.) Press the Num Lock key again to deactivate the numeric keypad.
<b>Directional Arrows</b>	The Up, Down, Left, and Right arrow keys move the pointer on the screen.
<b>Applications</b> 	The Applications key displays a shortcut menu in certain software applications. Pressing this key is equivalent to clicking the right mouse button.
<b>Windows</b> 	The key with the Microsoft® Windows® logo, displays the Start menu. Pressing this key is equivalent to clicking Start on the taskbar.
<b>INDICATORS</b>	<b>FUNCTION</b>
<b>Num Lock</b>	The Num Lock indicator lights when the numeric keypad is activated. When the indicator is off, the directional arrow and correction keys on the numeric keypad area are active.
<b>Caps Lock</b>	The Caps Lock indicator lights up to advise you that the keyboard is set to type letters in uppercase. When the indicator is off, the letters appear in lower case as you type.
<b>Scroll Lock</b>	The Scroll Lock indicator lights up to advise you that your screen's scrolling pattern has changed. When the indicator is off, the screen scrolls normally. This function is not available with all software applications.

---

## About the Remote Control

The remote control is supplied with VAIO® computers that are equipped with Giga Pocket® Personal Video Recorder features\*. The remote control can start and stop video recording and playback, select channels, and set viewing preferences. This section describes the basic functions of your remote control.

### Remote control

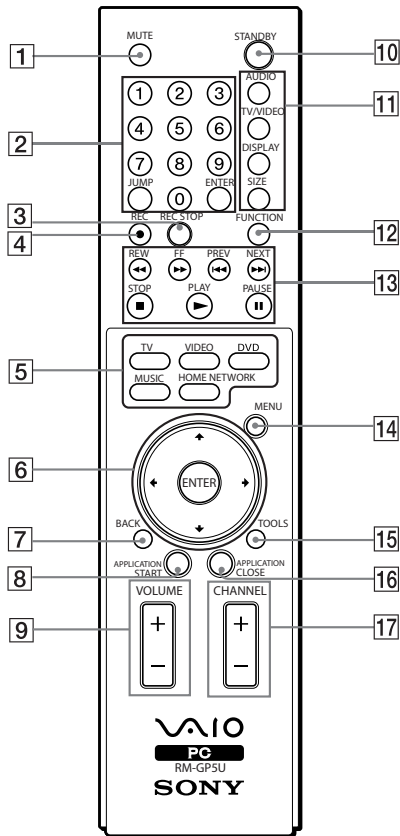

\* See the online specifications sheet for information about your computer's hardware configuration.

---

**1 MUTE button**

Press to turn off the sound. Press again to restore the sound.

---

**2 Channel number buttons (0-9)**

Press to select specific channels.

(Press the **ENTER** button to activate channel selection.)

**JUMP button**

Press to go to the previous channel. Press again to return to the current channel.

**ENTER button**

Press to activate channel selection. See **Channel number** buttons.

---

**3 REC STOP button**

Press to stop recording.

(Note: The **REC STOP** function is available for Giga Pocket software only.)

---

**4 REC button**

Press to begin recording.

(Note: The **REC** function is available for Giga Pocket software only.)

---

**5 TV button**

Press to change from the on-screen image to the TV/Recording deck.

**VIDEO button**

Press to start the Giga Pocket playback deck.

(Note: You cannot change the input source while recording.)

**DVD button**

Press to start the DVD player software program.

**MUSIC button**

Press to launch the SonicStage software.

**HOME NETWORK button**

Press to launch the VAIO Media.

---

**6 Direction and ENTER buttons**

Press a direction arrow to navigate. Press **ENTER** to select.

---

**7 BACK button**

Press to return to the previous screen.

(Note: This function is not available for Giga Pocket software.)

---

**8 APPLICATION START button**

Press to open a shortcut menu of software programs to start. Use the direction arrows to navigate to a specific software program and press the **APPLICATION START** button to select and start the program.

---

**9 VOLUME button**

Press to raise or lower the volume.

---

**10 STANDBY button**

Press to place the system into Stand by mode.

(Note: You cannot place the computer into Stand by mode when certain Giga Pocket functions are running.)

---

**11 AUDIO button**

Press to view available sound mode options on the monitor/display.

**TV/VIDEO button**

Press to change the on-screen image from the TV/Recording deck to external video equipment, such as your VCR.

(Note: You cannot change the input source while recording.)

**DISPLAY button**

During DVD playback in full screen mode, press to show the settings window. When using Giga Pocket software, press to display the TV/Recording deck and playback deck screens. Press again to hide these views.

**SIZE button \***

Press to view the current software in full-screen size. Press again to return the view to its original size.

---

**12 FUNCTION button**

When using SonicStage software, press to change from the music drive (hard disk drive) to the CD.

---

**13 REW and FF buttons**

Press to rewind or fast-forward.

**PREV and NEXT buttons**

Press to move back to the previous screen or forward to the next screen.

**STOP button**

Press to stop playback.

**PLAY button**

Press to begin playback.

**PAUSE button**

Press to pause playback.

---

**14 MENU button**

Press to view a shortcut menu of available options for a software program.

Press again to hide this menu.

(Note: For the Giga Pocket software program, the **Select A Cabinet** window displays. Press the button again to hide this window.)

---

---

**15 TOOLS button**

The function of this button may vary between DVD media. See the DVD player software instructions for details.

---

**16 APPLICATION CLOSE button**

Press to view a shortcut menu of software programs to close. If more than one software program is open, use the direction arrows to navigate to a specific program and press the **Application Close** button again to close the program.

---

**17 CHANNEL button**

Press to change channels automatically (no number input required).  
(Note: This function is available for Giga Pocket software only.)

---

\* This function is available on selected models.

 For more details about the function buttons on your remote control, see the Giga Pocket software Help.

***To set up the remote control***

Insert two AA batteries (supplied) into the remote control as shown.

***Inserting batteries into the remote control***

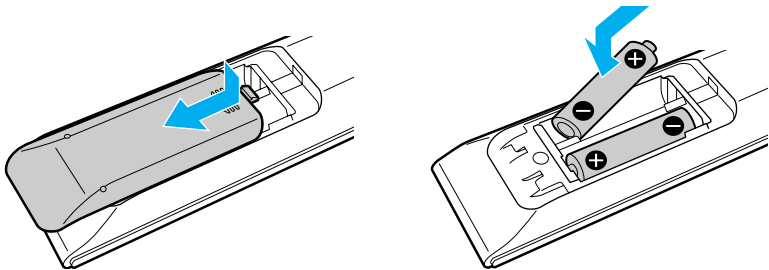

 If your remote control does not operate properly, the batteries may need to be replaced. When your remote control is not being used for extended periods of time, remove the batteries to avoid possible damage from battery leakage.



# Setting Up Your Computer

*Your computer may not be equipped with all of the hardware features described in the section. The location of the controls, ports, and jacks may vary from the illustrations shown. For details on your computer's hardware configuration, see the specifications sheet on the Sony Online Support Web site at <http://www.sony.com/pcsupport>.*

## Connecting a Display (Monitor)

The location and availability of the monitor ports may vary, depending on the model purchased. See the specifications sheet for your computer on the Sony Online Support Web site at <http://www.sony.com/pcsupport>, for details about your computer's hardware configuration

- 1 Plug the display's cable into the appropriate monitor port.
- 2 If necessary, plug the display's cable into the back of the display.

### To connect a display

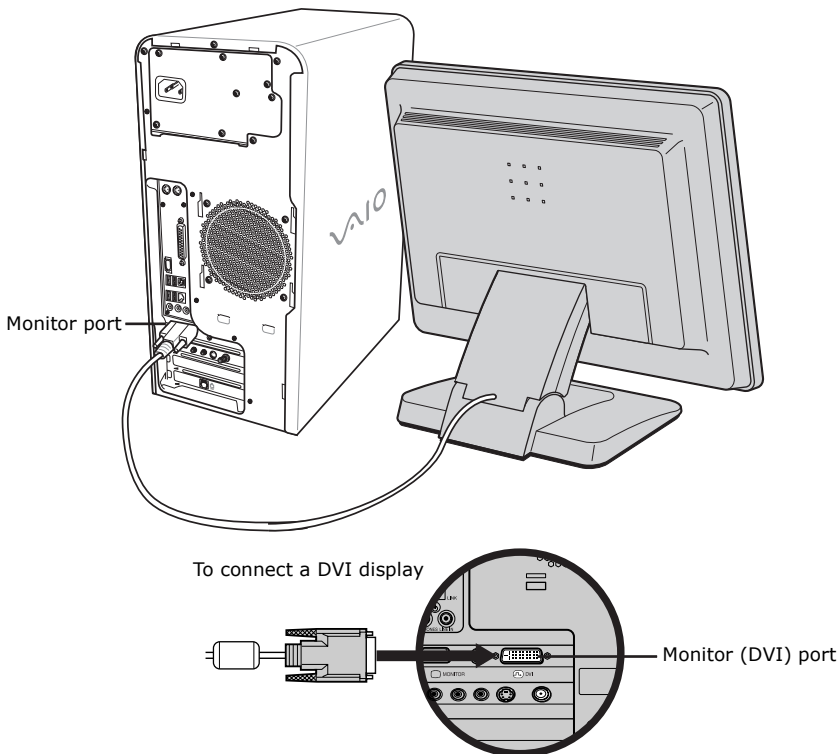

 Install your computer in an area where you can easily reach the power outlet in the event of an emergency.



## Connecting the Speakers

The right and left speakers are attached. The right speaker has a speaker wire with a jack connector and an AC power cord that supplies power to both speakers.

- 1 From the right speaker, plug the jack connector into the Headphones jack located on the back panel of your computer.
- 2 From the right speaker, plug the AC power cord into a grounded AC wall outlet or surge suppressor.

### *To connect the speakers*

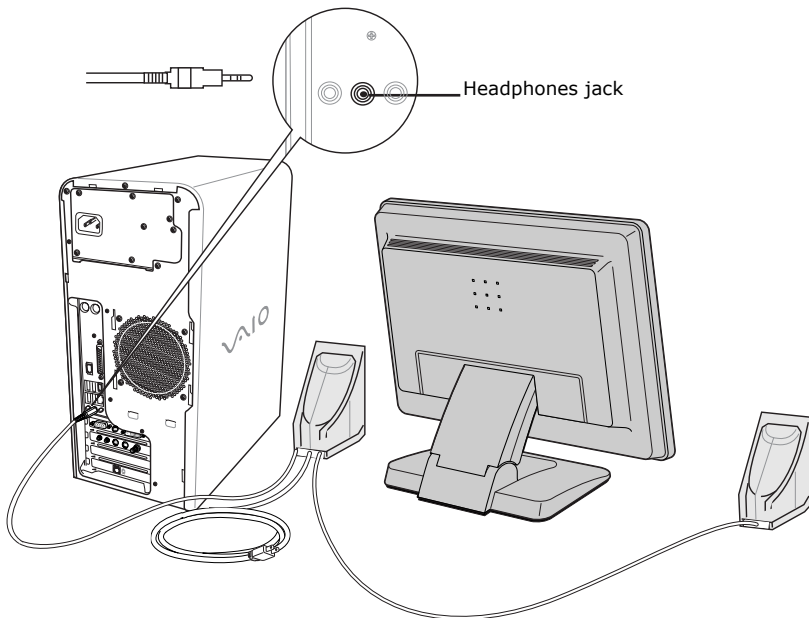

## Connecting the Keyboard and Mouse

- 1 Plug the keyboard cable into the keyboard port on the back of the computer.
- 2 Plug the mouse cable into the mouse port on the back of the computer.

*To connect the keyboard and mouse*

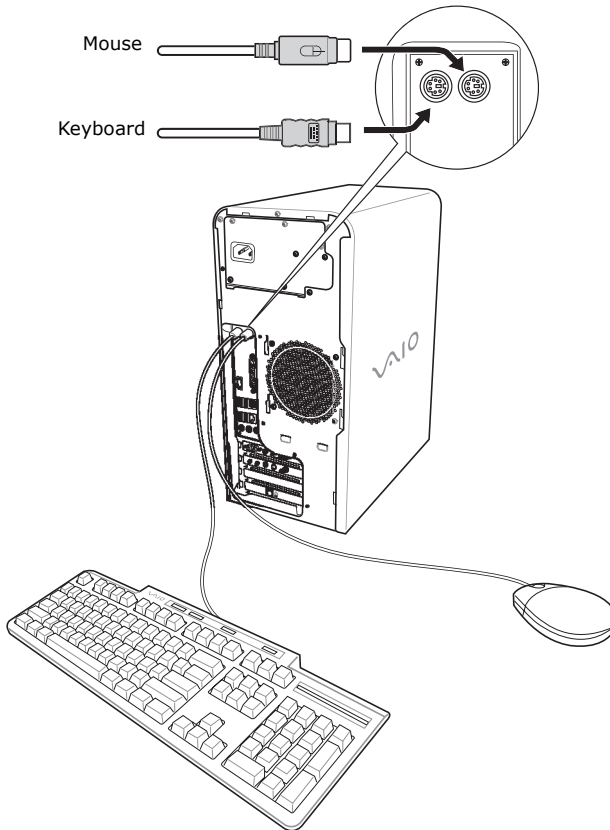

### ***To use an optical mouse***

An optical mouse requires an ideal surface in order to provide proper pointing and tracking.

- ❑ Use surfaces such as plain paper, card stock, or fabric that have minimal repetitive patterning.
- ❑ Avoid surfaces such as mirrors, smooth glass, or magazines that have half-tone printing.

## ***Connecting the Telephone and Modem Cables***

Your computer is equipped with a single modem line jack to connect the supplied modem cable to your telephone wall jack. To use your wall jack for your telephone and modem lines, purchase a “1-to-2” jack adapter device (splitter).

### ***To connect the modem cable***

- 1 Unplug your telephone from the wall jack.
- 2 Plug the modem cable (supplied) into the modem line jack located on the back panel of your computer
- 3 Plug the other end of the modem cable into the wall jack.

### ***To connect the telephone and modem cables***

- 1 Unplug your telephone cable from the wall jack.
- 2 Insert the telephone cable into one of the RJ-11 jacks on an optional “1-to-2” jack adapter device (splitter).
- 3 Insert one end of the modem cable (supplied) into the other RJ-11 jack on the splitter device.

*To connect the telephone and modem cables*

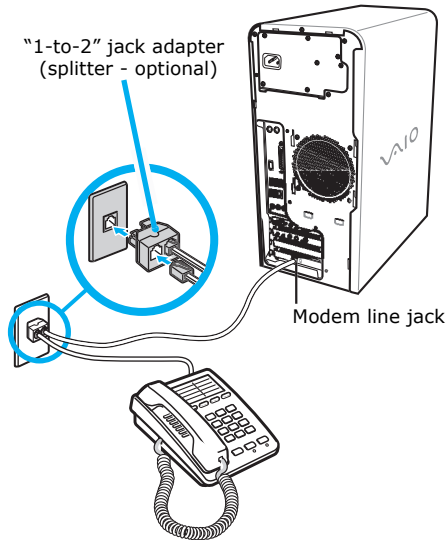

- 4 Insert the plug end of the splitter device into the wall jack.
- 5 Plug the modem cable into the modem line jack located on the back panel of the computer.



**Your computer has a protective sticker  covering the Ethernet port located on the rear panel. Connect only 10BASE-T and 100BASE-TX cables to the Ethernet port. Using other cables or a telephone cable may result in an electric current overload that can cause a malfunction, excessive heat, or fire in the Ethernet port. For help on connecting to a network, see your network administrator.**

## Connecting the Power Cords

- 1 Plug the power cord into the AC Input port, located on the back panel of the computer.
- 2 Plug both the display and computer power cords into a grounded AC wall outlet or a power strip.

### *To connect the power cords*

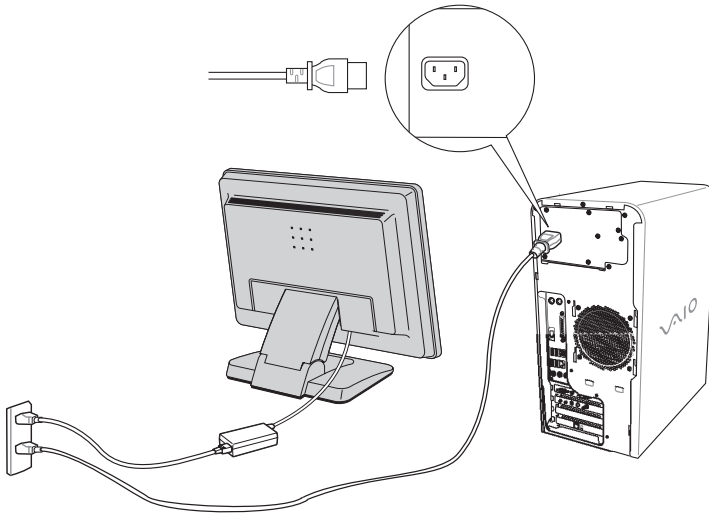

## Turning On Your Computer

When you start your system for the first time, your computer may detect new equipment and display a dialog box that prompts you to restart your computer. Respond to this prompt immediately.

- 1 Press the power button on the computer to turn on the power.
- 2 Press the power button on the display to turn on the power.
- 3 Press the power button, located on the side of the right speaker, to turn on the power.

### To turn on your computer

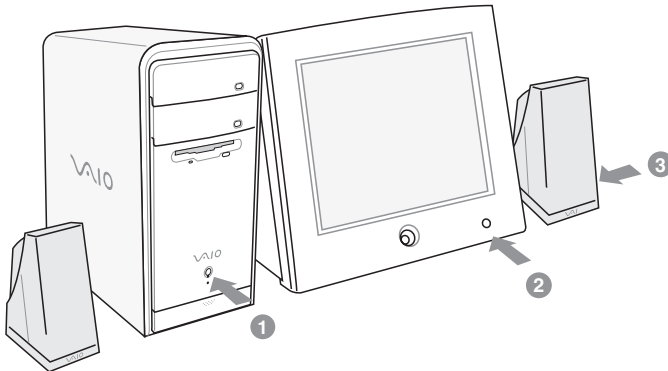

## Registering Your Computer

Take advantage of Sony's commitment to quality customer support and receive these benefits by registering your computer:

- ❑ **Sony Customer Support** — Communicate with a Support Representative to troubleshoot problems you may be having with your computer.
- ❑ **Limited warranty** — Protect your investment. See the Limited Warranty Card for more details.

 You are prompted to register your computer the first time you turn on the unit. Follow the on-screen instructions to complete the registration process. If you are not able to register your computer during the first session, you are provided with additional registration opportunities later.

## Turning Off Your Computer

Follow these steps when you are ready to turn off your computer for an extended period of time.



**To avoid loss of data, do not use the Power button to turn off the computer.**

### To turn off your computer

- 1 Click **Start** in the Windows® taskbar, then select **Turn Off Computer**.  
The **Turn Off Computer** dialog box appears.
- 2 Select the **Turn Off** option.

 Respond to any prompts about saving your documents.

- 3 Wait for your computer to turn off automatically—the power indicator light turns off.
- 4 Turn off any peripheral devices connected to your computer.

 If you plan to stop using your computer for a short period of time, use Stand by mode.

### About the power button

If your system stops responding, press and hold the Power button for more than six seconds to force your system to shut down. You may need to repeat this procedure if your system does not shut down on the first attempt.



# Troubleshooting

*This section describes how to troubleshoot common problems. You can also find helpful information on how to use your computer's hardware features and preinstalled software. Your computer may not be equipped with all of the features or software discussed in this section, depending on the system configuration purchased.*

## **My computer does not start.**

- ❑ Verify that the computer is plugged into a power source and that it is turned on. Check that the power indicator is lit on the front panel of the computer.
- ❑ Confirm that a disk is not in the floppy disk drive\* (unless you are using a bootable floppy disk).
- ❑ Confirm that a CD is not in an optical drive (unless you are using a bootable CD).
- ❑ Confirm that the power cord and all cables are connected firmly.
- ❑ If you plugged the computer into a power strip or Uninterruptible Power Supply (UPS), make sure the power strip or UPS is turned on and working.
- ❑ Verify that the monitor is plugged into a power source and turned on.  
If your system has a built-in monitor, confirm that it is plugged into an appropriate power source and that the system is turned on.
- ❑ Verify that the brightness or contrast control dials are adjusted correctly. (See the manual supplied with your display for details.)
- ❑ Confirm that the computer is not in Stand by mode by pressing any key on the keyboard.

---

\* Certain VAIO computers are not equipped with a floppy disk drive. You can purchase this equipment separately.

## **What can I do if my computer or software stop responding?**

You can try to locate and close the software program that has stopped responding.

- 1 Press the **Ctrl+Alt+Delete** keys. The **Windows Task Manager** window appears.
- 2 From the Applications tab, locate the software program that has the status message, “**Not responding.**”
- 3 Select the software program that has a **Not Responding** status and click **End Task**. Windows attempts to close the program.

If your computer does not respond or the software program does not close:

- 1 Save and close any open files, if possible.
- 2 Press the **Alt+F4** keys. The **Shut Down Windows**<sup>\*</sup> window appears.
- 3 Click the drop-down list box and select **Restart**.
- 4 Click **OK**. The computer turns off and restarts.

If the **Shut Down Windows** window does not appear:

- 1 Press **Ctrl+Alt+Delete** keys. The **Windows Task Manager** window appears.
- 2 Click **Shut Down**.
- 3 Restart your computer.

If your computer still does not respond and you cannot restart, shut down your computer by pressing and holding the power button for more than six seconds.

If the software program continues to stop responding or causes your computer to stop responding, contact the software publisher or designated technical support provider.



**Pressing and holding the power button for more than six seconds may result in the loss of data from files that are currently open.**

<sup>\*</sup> The window text may vary, depending on the Microsoft Windows XP operating system installed on your computer.

# Support Options

*Sony provides several options to help solve common problems or to locate support for your VAIO® computer. This section describes all available resources and offers suggestions on how to access this information for maximum results.*

## **Immediate Help and Support**

You can locate helpful information immediately by consulting your hard copy guides and supplements, or by accessing the online Computer User Guide and the individual software Help files.

Your computer is supplied with these support options:

- ❑ **VAIO® Computer Quick Start** — The Quick Start contains information on how to set up your computer quickly and easily. You can find instructions on how to connect power cords, cables and peripheral devices, and register your computer with Sony®. The Quick Start can also provide troubleshooting support, if problems occur.
- ❑ **VAIO® Computer User Guide** — The online User Guide provides information about configuring, maintaining, and upgrading your computer. This support resource offers a variety of available topics, enabling you to quickly view specific information using context-sensitive search features. To access the online guide:
  - 1 Click **Start** in the Windows® taskbar, then click **Help and Support**.
  - 2 From the **VAIO Help And Support Center** menu, click **VAIO User Guide**.
- ❑ **Specifications** — The online specifications sheet describes the hardware and software configuration of your VAIO computer. To view this online information go to <http://www.sony.com/pcsupport>.

- ❑ **Preinstalled software Help files** — Each preinstalled software program provides online Help within the software, that describes the software's features. In these Help files, you can find tutorials that teach you to use the software and locate troubleshooting support, should problems occur. To access software Help files:
  - 1 Click **Start** in the Windows taskbar and point to **All Programs**. A submenu appears, listing all preinstalled software programs.
  - 2 Click the desired software program.\* The software's main window appears.
  - 3 From the menu bar, click **Help**. The software program's **Help** appears.
- ❑ **VAIO Software** — Provides specific information on preinstalled software on your computer.

To access this online software information

  - 1 Click **Start** in the Windows taskbar.
  - 2 Click **Welcome to VAIO life**.

## ***Resources for Additional Help and Support***

If the information provided with your VAIO® computer does not offer an immediate solution, or you would like to get direct support, try these additional help and support resources.

### ***Sony Online Support Web site***

Online help and support are available 24 hours a day, seven days a week, when you visit the Sony Online Support Web site. You can access the Web site at <http://www.sony.com/pcsupport>.

The Sony Online Support Web site provides:

- ❑ Information about your specific computer model, such as
  - ❑ hardware and software specifications.
  - ❑ upgrade and maintenance procedures<sup>†</sup>.
  - ❑ safety and legal information.
  - ❑ quick solutions to common problems.

---

\* You can locate the online Help for Sony® software programs by pointing to the individual software program's icon and selecting Help from the submenu.

† Upgrade and maintenance information may not be available for all computer models.

- ❑ An automated tutorial library that contains interactive, easy-to-understand lessons on using your computer's hardware and software features.
- ❑ Links that enable you to:
  - ❑ quickly find the nearest Sony service center locations.
  - ❑ arrange for repairs or check repair status.
  - ❑ review warranty information.
  - ❑ e-mail your question or comments to the Sony Customer Information Services Center.
  - ❑ check pricing and availability for products, accessories and parts, as well as purchase online.
  - ❑ access the Sony Solutions Knowledge Base, a database that contains answers to many frequently asked questions.

### ***Sony Customer Information Services Center***

If other support options do not resolve your issue, you can contact a Sony Support representative directly.

Before making a call to the Sony Customer Information Services Center, have this basic information readily available.

- 1 VAIO® computer system type.
- 2 Model number.
- 3 Serial number\*.

*Example:* 

- 4 Operating system.
- 5 Hardware feature or software program that has a problem. (See the online *VAIO® Computer User Guide* for the appropriate software technical support information.)
- 6 Brief description of the issue.

For VAIO® computers purchased in the U.S. and Canada, contact a Sony Support representative at 1-888-476-6972.

---

\* The serial number is located on the back panel of your computer. The serial number is on a white barcode label.





For customer support information, go to:  
<http://www.sony.com/pcsupport>

VAIO Homepage  
<http://www.vaio.net>

© 2004 Sony Electronics Inc.

Printed in USA

2-102-329-01