

Compact Disc Recorder

Operating Instructions

Owner's Record

The model and serial numbers are located on the rear panel. Record the serial number in the space provided below. Refer to them whenever you call upon your Sony dealer regarding this product.

Model No. _____ Serial No. _____



RCD-W50C/W10

WARNING

To prevent fire or shock hazard, do not expose the unit to rain or moisture.

To prevent fire, do not cover the ventilation of the apparatus with newspapers, table-cloths, curtains, etc. And don't place lighted candles on the apparatus.

To prevent fire or shock hazard, do not place objects filled with liquids, such as vases, on the apparatus.



Don't throw away the battery with general house waste, dispose of it correctly as chemical waste.

CLASS 1 LASER PRODUCT
LUOKAN 1 LASERLAITE
KLASS 1 LASERAPPARAT

This appliance is classified as a CLASS 1 LASER product.

This label is located on the rear exterior.

The following caution label is located inside the apparatus.



For the customers in the U.S.A.

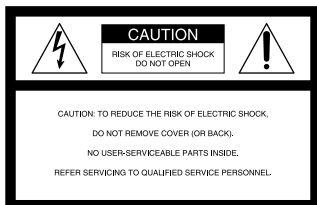

This symbol is intended to alert the user to the presence of uninsulated "dangerous voltage" within the product's enclosure that may be of sufficient magnitude to constitute a risk of electric shock to persons.



This symbol is intended to alert the user to the presence of important operating and maintenance (servicing) instructions in the literature accompanying the appliance.

CAUTION

You are cautioned that any changes or modifications not expressly approved in this manual could void your authority to operate this equipment.

WARNING

This equipment has been tested and found to comply with the limits for a Class B digital device, pursuant to Part 15 of the FCC Rules. These limits are designed to provide reasonable protection against harmful interference in a residential installation. This equipment generates, uses, and can radiate radio frequency energy and, if not installed and used in accordance with the instructions, may cause harmful interference to radio communications. However, there is no guarantee that interference will not occur in a particular installation. If this equipment does cause harmful interference to radio or television reception, which can be determined by turning the equipment off and on, the user is encouraged to try to correct the interference by one or more of the following measures:

- Reorient or relocate the receiving antenna.
- Increase the separation between the equipment and receiver.
- Connect the equipment into an outlet on a circuit different from that to which the receiver is connected.
- Consult the dealer or an experienced radio/TV technician for help.

As the laser beam used in this unit is harmful to eyes, do not attempt to disassemble the cabinet. Refer servicing to qualified personnel only.

The following caution label is located inside the apparatus.

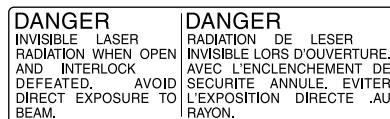

FOR THE CUSTOMERS IN CANADA

This Class B digital apparatus complies with Canadian ICES-003.

CAUTION

TO PREVENT ELECTRIC SHOCK, DO NOT USE THIS POLARIZED AC PLUG WITH AN EXTENSION CORD, RECEPTACLE OR OTHER OUTLET UNLESS THE BLADES CAN BE FULLY INSERTED TO PREVENT BLADE EXPOSURE.

Contents

Getting Started

Unpacking	6
Hooking Up the System	6
This Unit Can Use the Following Discs	7

Basic Operations

Playing a CD	8
Using the Display	9
Locating a Specific Track	11
Locating a Particular Point in a Track	12
Playing Tracks/Discs Repeatedly (Repeat Play)	13
Playing in Random Order (Shuffle Play)	14
Creating Your Own Program (Program Play)	15

Recording/Editing

Notes on Recording	16
Useful Tips for Recording	16
Synchro-Recording a CD to CD-R or CD-RW	18
Recording on a CD-R or CD-RW Manually	20
Adjusting the Recording Level	21
Marking Track Numbers While Recording	22
Recording the Original Sound of the Program Source (Direct Recording Function)	23
Fading In and Out (Fader)	23
Finalizing a CD-R or CD-RW	24
Unfinalizing a CD-RW	25
Erasing Tracks of a CD-RW	25
Labeling Tracks/Discs	26

Additional Information

Using the Setup Menu	28
Messages	29
Self-diagnosis Function	30
System Limitations	30
Troubleshooting	31
Specifications	Back cover

Welcome

Thank you for purchasing this Sony Compact Disc Unit. Before operating the unit, please read this manual thoroughly and retain it for future reference.

About This Manual

The instructions in this manual are for 2 models: RCD-W50C and RCD-W10.

RCD-W50C is the model used for illustration purposes.

Conventions

- Instructions in this manual describe the controls on the unit. You can also use the controls on the remote if they have the same or similar names as those on the unit.
- The following icons are used in this manual:



Indicates that you can do the task using the remote.

Precautions

On safety

- Should any solid object or liquid fall into the cabinet, unplug the unit and have it checked by qualified personnel before operating it any further.
- The use of optical instruments with this product will increase eye hazard.

On power sources

- Before operating the unit, check that the operating voltage of the deck is identical with your local power supply. The operating voltage is indicated on the nameplate at the rear of the unit.
- The unit is not disconnected from the AC power source (mains) as long as it is connected to the wall outlet, even if the unit itself has been turned off.
- If you are not going to use the unit for a long time, be sure to disconnect the unit from the wall outlet. To disconnect the AC power cord, grasp the plug itself; never pull the cord.
- AC power cord must be changed only at the qualified service shop.

On condensation in the unit

If the unit is brought directly from a cold to a warm location, or is placed in a very damp room, moisture may condense on the lenses inside the unit. Should this occur, the unit may not operate properly. In this case, remove the CD, CD-R, or CD-RW and leave the unit turned on for about an hour until the moisture evaporates.

On handling discs

- To keep the disc clean, handle it by its edge. Do not touch the surface.
- Do not stick adhesive papers or tapes onto the disc.



- Only regular circular discs can be used in this unit. Irregularly shaped discs, such as star or heart-shaped discs may damage the unit.
- If there is glue or a similar substance on the disc, remove it completely before using the disc.

On storage

- Do not expose the disc to direct sunlight or heat sources such as hot air ducts, nor leave it in a car parked in direct sunlight as there can be a considerable rise in temperature inside the car.
- Store discs in their cases. Do not store discs either stacked horizontally or standing vertically without their cases.

On cleaning

- Fingerprints or dust on the disc may cause poor sound reproduction or sound dropout.
- Before playing a disc, clean it with a cleaning cloth. Wipe the disc from the center out.



- If the disc is still dirty after being wiped with a cleaning cloth, wipe it again with a slightly moistened cloth. Then wipe off the residual moisture with a dry cloth.
- Do not use solvents such as benzene, thinner, commercially available cleaners, or antistatic spray intended for vinyl LPs.

Note on High-Speed Synchro-Recording

Certain CD conditions may cause sound dropout or noise in the recording results, or even create unwanted tracks on the CD-R or CD-RW. If this happens, clean the CD as instructed in “On cleaning” above, and record material to the CD-R or CD-RW using normal speed Synchro-Recording only.

Note on CD-R or CD-RW playback

When you playback a CD-R or CD-RW recorded by a CD-R or CD-RW recorder, you may not be able to playback depending on the recording conditions (e.g., dirty disc, etc.). Also, you should note that you need to finalize a CD-R or CD-RW before playing back on another system other than the one used to make the recording. (Finalizing is a process to complete the recording.)

After finalizing a CD-R, you can play it in any conventional CD player. However, depending on the state of the recording, there may be sound skips during playback.

After finalizing a CD-RW, you can play it in a CD-RW compatible player only.

Unpacking

Check that the following items are included:

- Audio connecting cords
- Phono jack × 2 (red/white) ↔ Phono jack × 2 (red/white) (2)
- Remote commander (remote) (1)
- Size AA (R6) batteries (2)

Inserting batteries into the remote

You can control the unit using the supplied remote.

Insert two size AA (R6) batteries by matching the ⊕ and ⊖ ends on the batteries to the markings inside the compartment. When using the remote, point it at the remote sensor  on the unit.

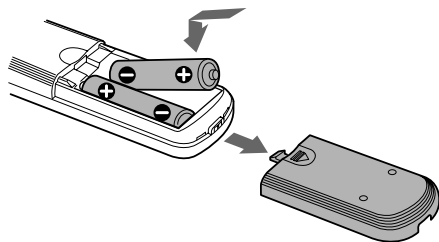

Tip

With normal use, the batteries should last for about six months. When the remote no longer operates the unit, replace both batteries with new ones.

Notes

- Do not leave the remote near an extremely hot or humid place.
- Do not drop any foreign object into the remote casing, particularly when replacing the batteries.
- Do not expose the remote sensor to direct light from the sun or lighting apparatus. Doing so may cause a malfunction.
- If you don't use the remote for an extended period of time, remove the batteries to avoid possible damage from battery leakage and corrosion.

Hooking Up the System

This section describes how to hook up the unit to an amplifier. Be sure to turn off the power of each component before making the connections.

Connecting the unit to an amplifier

Connect the amplifier to the ANALOG IN/OUT jacks using the audio connecting cords (supplied), making sure to match the color-coded cords to the appropriate jacks on the components: red (R) to red and white (L) to white. Be sure to make connections firmly to prevent hum and noise.

Audio connecting cords (supplied) (2)

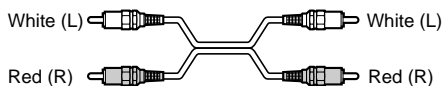

RCD-W50C/W10

Amplifier

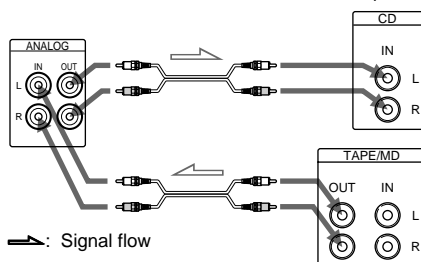

Connecting the unit to a digital component

Connect a component such as digital amplifier, CD player, DAT deck, or MD deck through the DIGITAL OPTICAL IN/OUT connectors with the optical digital cord (not supplied). Plug in the cord.

Optical digital cord (not supplied)



Setting the voltage selector (voltage selector equipped models only)

Check that the voltage selector on the rear panel of the unit is set to the local power line voltage. If not, set the selector to the correct position using a screwdriver before connecting the AC power cord to a wall outlet.

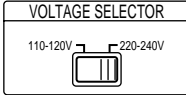

Connecting the AC power cord

Connect the AC power cord to a wall outlet.

This Unit Can Use the Following Discs

The unit can use three types of discs as follows:

Audio CD



Discs with these logos can be played by both DECK A (the CD player section) and DECK B (the CD-R or CD-RW recording section) of the unit.

Audio CD-R



Discs with this logo are **recordable only one time**. When you finalize the disc (page 24), you can play it in either DECK A (the CD player section) or DECK B (the CD-R or CD-RW

recording section), or any conventional CD player (you may not be able to play it in some CD players), including home, car, and portable models. (An unfinalized disc can be played only in DECK B.) When you buy a CD-R, please note that you must buy an audio CD-R. A CD-R designed for computer use will not work in this unit.

Audio CD-RW



Discs with this logo are **recordable, and also re-writable**. When you finalize the disc (page 24), you can play it in either DECK A (the CD player section) or DECK B (the CD-R or CD-RW recording section), and CD-RW compatible players. They will not play back in most current CD players unless the player is CD-RW compatible. (An unfinalized disc can be played only in DECK B.)

When you buy a CD-RW, please note that you must buy an audio CD-RW. A CD-RW designed for computer use will not work in this unit.



This logo means that a unit is compatible with Audio CD-R and Audio CD-RW (both Audio CD-R and Audio CD-RW can be used).

Playing a CD

This unit has two decks.

In this manual, the CD player section is just called DECK A, and the CD-R and CD-RW recording section is called DECK B.

When using the remote, set SELECT to CD for operations on DECK A (the CD player section), or to CDR for operations on DECK B (the CD-R or CD-RW recording section).

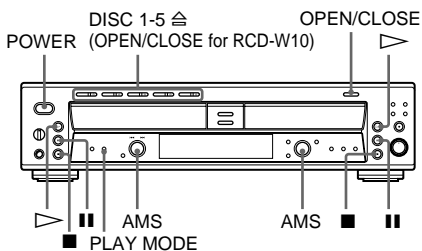

- 1 Turn on the amplifier and adjust the volume to the minimum.
- 2 Set the function of the connected amplifier with its input selector.
- 3 Press POWER.
- 4 Press OPEN/CLOSE (or one of the DISC 1-5 buttons) for DECK A of RCD-W50C and place a disc on the inner circle of DECK A (or B). Press OPEN/CLOSE (or the button) again to close the disc tray.



With the label side up

- 5 For DECK A of RCD-W50C, press PLAY MODE repeatedly to select the Continuous play mode.

When you select	The unit plays
ALL DISCS	All discs in the unit consecutively in the order of the disc number.
1 DISC	Only one disc you have selected.

- 6 Press \triangleright .
The unit starts playing. Adjust the volume on the amplifier.

To	Do the following:
Stop playback	Press ■.
Pause playing	Press \parallel . Press the button again or press \triangleright to resume playing.
Select the disc (for DECK A of RCD-W50C)	Press one of the DISC 1-5 buttons.*
Go to the next disc (for DECK A of RCD-W50C)	Press D. SKIP on the remote.
Go to the next track	Turn AMS**clockwise (or press \blacktriangleright on the remote).
Go to the beginning of the current track or the preceding track	Turn AMS counterclockwise (or press \blacktriangleleft on the remote).
Remove the disc	Press OPEN/CLOSE (or \triangle), whichever contains the disc you want to remove after stopping play.

* When the disc is in the unit, the indicator lights up in orange, then it turns green when the disc is selected.

**AMS: Automatic Music Sensor

Tips

- You can start playing with the track selected in Step 6.
 - 1 Turn AMS (or press \blacktriangleleft / \blacktriangleright or the number buttons on the remote) to select the track you want to play using the display*.
 - 2 Press \triangleright .
- *See "Using the Display" on page 9.
- You can remove or load discs while playing the other deck. Press OPEN/CLOSE (or \triangle) of the deck that is not currently playing to open that tray, and remove or load a disc.
- The DISC 1-5 button indicator lights up when the disc is in the tray. The indicator turns to green when the disc is selected.
- You can connect a headphone to the PHONE jack on the front panel. Turn the PHONE LEVEL control to adjust the volume.
- You can replace any discs in the other disc trays while playing a disc in DECK A of RCD-W50C. Press OPEN/CLOSE (or \triangle) of the deck that is not currently playing to open that tray, and remove or load a disc.

Notes

- You can play unfinalized CD-Rs or CD-RWs only in DECK B. For the detailed explanation about finalizing, see "Finalizing a CD-R or CD-RW" on page 24.
- Do not leave the disc tray open when the unit is not in use to prevent dust and dirt from entering and prevent damage to the disc tray.
- When you turn on the unit, you will hear some mechanical noise from the unit. This is not a malfunction.

Using the Display

You can check information about the disc using the front panel display.

When using the remote, set SELECT to CD for operations on DECK A, or to CDR for operations on DECK B.

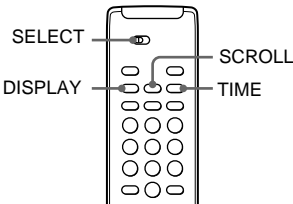
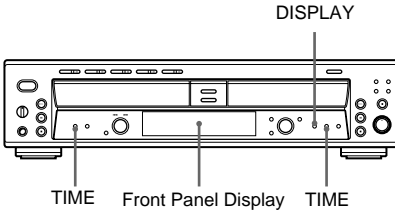

Changing the display

Press DISPLAY while the unit is stopped or playing. Each time you press the button, you can change the display as follows:

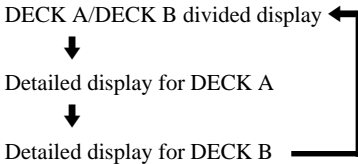

DECK A/DECK B divided display

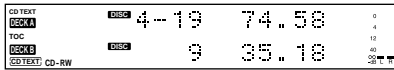

Detailed display for DECK A

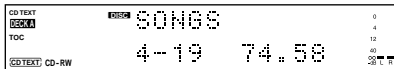

Detailed display for DECK B



Tips

- The disc titles and track titles are displayed as follows:
When either of the detailed displays are selected, the disc title appears whenever the unit is stopped. The title of the current track appears when a track is playing.
To label a disc and its tracks, see "Labeling Tracks/ Discs" on page 26.
- You can scroll disc or track titles that do not fit entirely into the display. Press SCROLL on the remote to see the rest of the title. Press SCROLL again to pause scrolling, and again to continue scrolling.

Display while the unit is stopped

The information appears as follows:

DECK A

The total track number and total playing time



Tip

When you put a CD containing a CD text in the disc tray, "CD TEXT" lights up in the display.

DECK B

When you placed an unfinalized CD-R or CD-RW in DECK B, you can also check the remaining recordable time by pressing TIME.

The information appears as follows:

The total track number and total playing time



The remaining recordable time of the disc (only the unfinalized CD-R or CD-RW)



Tip

When you put a CD containing a CD text in the disc tray, "CD TEXT" lights up in the display.

Display while playing

Press **TIME** repeatedly while the unit is playing. Each time you press the button, the display for any deck that has a disc inside changes as follows:

DECK A

The track number and playing time

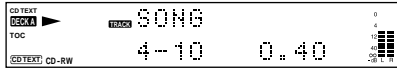

The track number and remaining time of the track currently being played

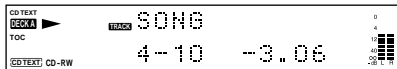

The total remaining time of the disc (in Continuous play mode)



DECK B

The track number and playing time



The track number and remaining time of the track currently being played

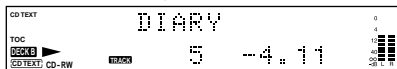

The total remaining time of the disc (in Continuous play mode)

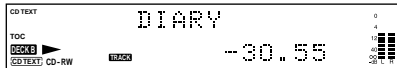

Display while recording

Press **TIME** repeatedly while recording. Each time you press the button, the display for DECK B changes as follows:

The track number and recording time of the track currently being recorded

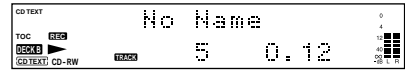

The total remaining time of the CD-R or CD-RW

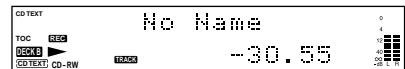

Display for disc information of DECK B

The indicators show which type of recordable disc is in the disc tray, and whether the recordable disc has been already finalized.

TOC indicator

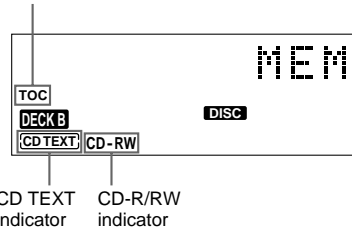

The CD-R/RW indicator

When you put an unfinalized CD-R in the disc tray, "CD-R" lights up.

When you put a CD-RW disc in the disc tray, "CD-RW" lights up.

The TOC indicator

When you put an unfinalized CD-R or CD-RW in the disc tray, "TOC" lights up.

For details on finalizing, refer to page 24, and page 25 for unfinalizing.

The CD TEXT indicator

When you put a CD containing a CD text in the disc tray, "CD TEXT" lights up.

When "CD TEXT" is framed in red in the display of DECK B, CD TEXT information is not recorded. In this case, finalize the disc to record the information.

If you remove the disc or turn off the power before finalizing, CD TEXT information is erased.

Note

When you put a CD or finalized CD-R in the disc tray, "CD" lights up.

Locating a Specific Track

You can quickly locate any track while playing a disc by using the AMS (Automatic Music Sensor) dial on the deck, ◀◀ and ▶▶ buttons on the remote, or number buttons on the remote.

When using the remote, set SELECT to CD for operations on DECK A, or to CDR for operations on DECK B.

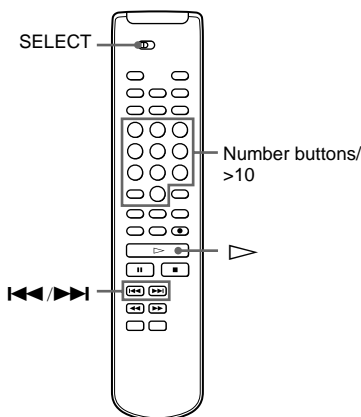
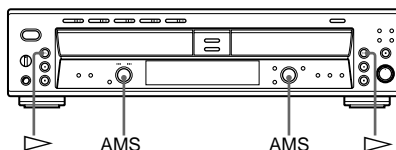

To locate	Do the following:
The next or succeeding tracks	During playback, turn AMS clockwise (or press ►► on the remote repeatedly) until you find the track.
The beginning of the current or preceding tracks	During playback, turn AMS counterclockwise (or press ◀◀ on the remote repeatedly) until you find the track.
A specific track number or track name directly	In stop mode, turn AMS (or press ◀◀/►►) on the remote repeatedly) until you find the track number or track name, and press ▷.

Tip

To pause playing at the beginning of a track, turn AMS (or press ◀◀/►► on the remote) after pausing playback.

Playing directly using the number buttons

You can playback a track directly by using the number buttons. Press the track number you want to play. When you select a track number over 10, press >10 first, then the corresponding number buttons.

Example:

To enter number 15, press >10, then 1 and 5.

Locating a Particular Point in a Track

You can locate a particular point in a track during playback or playback pause.

Before using the remote, set SELECT to CD for operations on DECK A, or to CDR for operations on DECK B.

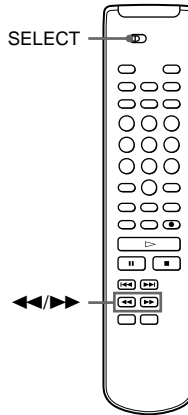

To locate a point	Do the following
While monitoring the sound	During playback, press and hold ◀◀ or ►► on the remote until you find the point.
While observing the display	During pause, press and hold ◀◀ or ►► on the remote until you find the point. You will not hear the sound during operation.

Tip

“-Over-” appears if the disc reaches the end. Turn the AMS dial counterclockwise (or press ◀◀ or ◀◀ on the remote).

Note

Tracks that are only a few seconds long may be too short to scan using the search function. For such tracks, it is better to play the disc at normal speed.

Playing Tracks/Discs

Repeatedly (Repeat Play)

You can play tracks repeatedly in any play mode.

Before using the remote, set SELECT to CD for operations on DECK A, or to CDR for operations on DECK B.

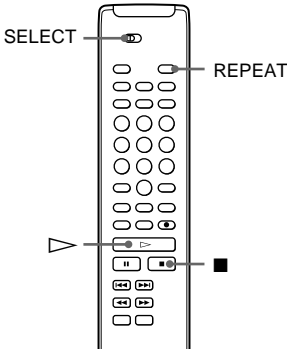

Repeating all tracks on the disc

Press REPEAT repeatedly until “REPEAT” lights up in the display, and then press ▷.

The unit repeats the discs/tracks as follows:

When the disc is played in	The deck repeats
ALL DISCS Continuous play (page 8)	All tracks on all discs.
1 DISC Continuous play (page 8)	All tracks on the current disc.
Shuffle Play (page 14)	All tracks on the current disc in random order.
Program Play (page 15)	All the same program.

To stop Repeat Play

Press ■.

To cancel Repeat Play

Press REPEAT repeatedly until “REPEAT” goes off.

Notes

- When the unit has repeated tracks in the same play mode five times, playback stops.
- When “ALL DISCS SHUFFLE” (page 14) is selected, you cannot repeatedly play all tracks on the disc (for DECK A of RCD-W50C).

Repeating only the current track

While the track you want to repeat is being played, press REPEAT repeatedly until “REPEAT 1” lights up.

To cancel Repeat 1

Press REPEAT repeatedly until “REPEAT 1” goes off.

Playing in Random Order (Shuffle Play)

You can have the unit “shuffle” tracks and play them in random order.

When using the remote, set SELECT to CD for operations on DECK A, or to CDR for operations on DECK B.

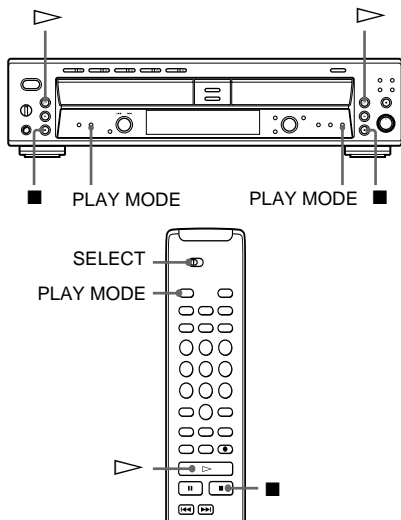

1 While the unit is stopped, press **PLAY MODE** repeatedly to select the Shuffle Play mode as follows:

When you select	The unit plays
ALL DISCS SHUFFLE (for DECK A of RCD-W50C)	All tracks on all discs in random order.
1 DISC SHUFFLE (for DECK A of RCD-W50C)	All tracks on the current disc in random order.
SHUFFLE (for DECK B of RCD-W50C and DECK A/B of RCD-W10)	All tracks on the disc in random order.

2 Press **▷**.

“**▷**” appears in the display while the unit is “shuffling” the tracks, and the track is played.

To stop Shuffle Play

Press **■**.

To cancel Shuffle Play

While the unit is stopped, press **PLAY MODE** until “SHUFFLE” goes off.

Tip

To play from the beginning of the current track again, turn AMS counterclockwise (or press **◀◀** on the remote). You cannot go back to tracks that have already been played.

Notes

- If “ALL DISCS SHUFFLE” is selected in the “REPEAT” setting, “REPEAT” is cancelled (for DECK A of RCD-W50C).
- You cannot change the **PLAY MODE** during playback.

Creating Your Own Program (Program Play)

You can specify the playback order of the tracks on a disc to create your own programs containing up to 25 tracks.

When using the remote, set SELECT to CD for operations on DECK A, or to CDR for operations on DECK B.

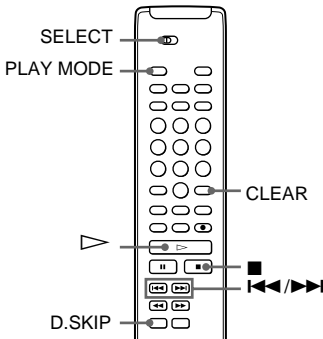
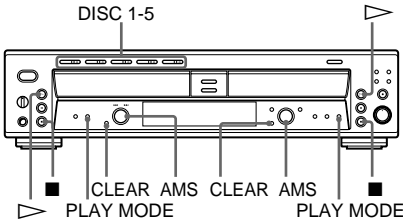

- 1 While the unit is stopped, press **PLAY MODE** repeatedly until “PROGRAM” lights up in the display.
- 2 For DECK A of RCD-W50C, press one of the DISC 1-5 buttons (or D. SKIP on the remote) to select the desired disc number.
- 3 Turn AMS to select the desired track number, then press AMS (or press ◀◀/▶▶ to select the desired track number, then press PLAY MODE on the remote).
- 4 To program additional tracks, repeat Step 3 (Steps 2 and 3 for DECK A of RCD-W50C).
- 5 Press ▷ to start Program Play.
The unit starts playing tracks in the programmed order.

To program all tracks on the selected disc

After displaying the first track number in Step 3 above, turn AMS counterclockwise (or press ◀◀ on the remote) to select “AL” instead of a track number.

To stop Program Play

Press ■.

To cancel Program Play

Press PLAY MODE repeatedly until “PROGRAM” goes off.

To erase the last programmed track

Press CLEAR. Each time you press the button, the last programmed track is erased.

Tips

- You can also select the track number using the number buttons on the remote in Step 3 above. See page 11.
- The program remains even after Program Play ends. When you press ▷, you can play the same program again.
- To check the total number of the programmed tracks, press TIME while the unit is stopped.

Notes

- You cannot create a program containing tracks from both DECK A and DECK B.
- “Step Full!” appears in the display when you program over 25 tracks. Erase the unnecessary tracks to enter other tracks.
- The program is erased when you turn the unit off.
- If the total time of the program exceeds 99 minutes 59 seconds, “--:--” appears in the display.
- You cannot change the PLAY MODE during playback.

Notes on Recording

- You cannot record over existing material. The unit automatically starts recording from the end of any existing material.
- Make sure that the remaining recordable time on the CD-R or CD-RW is longer than the playing time of a source CD, especially if you want to record all the tracks on the CD.
- If a message appears in the display, refer to “Messages” on page 29.
- With the following kinds of CDs, you may experience a reading failure or noise when recorded to a CD-R or CD-RW.
 - CD with adhesive labels attached to them
 - Irregularly shaped CDs (for example, heart or star shaped)
 - CDs with printed text concentrated on one side only
 - Old CDs
 - Scratched CDs
 - Dirty CDs
 - Warped CDs
- If the following occurs during CD playback or recording, a reading error may occur or noise may be produced in the recorded results:
 - The disc tray or other part of the system is bumped.
 - The system is placed on an uneven or soft surface.
 - The system is located near a speaker, door, or other source of vibration.
- Recording automatically stops if recording is paused for more than about 3 minutes.

Note on a copy protection

Some commercial CD may contain a copy protection code that will prevent the disc from being recorded. In this case, “Cannot Copy” and either “C12” or “C41” will appear alternately in the display.

Do not move the unit or disconnect the unit from power source in the following situation. Recording may not complete successfully.

- When “Finalize,” “Unfinalize,” “Erase,” or “OPC” appears in the display:
The unit is currently updating the table of contents (TOC).
- When “PMA Writing” appears in the display:
The unit is currently updating the track information.

Useful Tips for Recording

When using the remote, set SELECT to CDR.

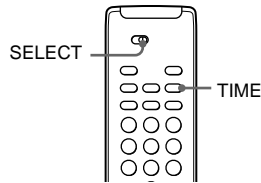
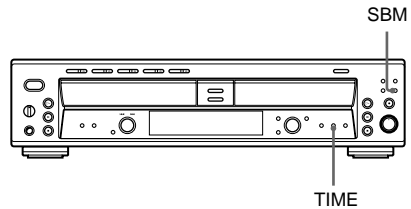

Checking the remaining recordable time on the CD-R or CD-RW

Press TIME repeatedly.

- Each time you press the button while the unit is stopped, the display alternates between total disc playing time and remaining recordable time on the CD-R or CD-RW (page 9).
- Each time you press the button while recording, the display alternates between the recording time of the current track and the remaining recordable time on the CD-R or CD-RW (page 10).

If “Auto Cut” appears in the display (Auto Cut Function)

There has been no sound input for about 30 seconds during recording. The 30 seconds of silence are replaced by a blank of about 3 seconds and the unit changes to recording pause.

If the unit continues pausing for about 3 minutes after the Auto Cut Function activated, recording stops automatically.

Note that this function does not activate if the unit has started recording from a blank portion or is synchro-recording from a CD on DECK A.

Tip

You can turn off the Auto Cut Function. For details, see “To turn off the Smart Space Function and Auto Cut Function” below. Note that when you turn off the Auto Cut Function, the Smart Space Function is also turned off automatically.

If “Smart Space” appears in the display (Smart Space Function)

There has been an extended silence of 4 to 30 seconds in length during recording. When the signal is input again, the silence is replaced with a blank of about 3 seconds and the deck continues recording.

Note that new track numbers may not be marked for portions recorded while this function is activated. Also, this function does not activate even if there has been an extended silence of 4 to 30 seconds in length when the deck started recording from the blank portion.

To turn off the Smart Space Function and Auto Cut Function

Set “Smart Space” in Setup Menu to “Off.” For details, see “Using the Setup Menu” (page 28).

Note

When you turn off the Smart Space Function, the Auto Cut Function is also turned off automatically.

Insert the silence into the end of the song (The function of adding Post Gap)

You can insert the silence of 2 seconds between the songs, when recording more than two tracks at once. The silence is inserted according to the following situations.

- When recording is stopped.
- When the disc of DECK A changes to the next disc during Synchro-Recording. (RCD-W50C only)

To use the function of adding Post Gap

Set “Post Gap” of the setup menu to “On” during stop. For details, see “Using the Setup Menu” on page 28.

Using the SBM (Super Bit Mapping) function

When you record through the ANALOG input, the SBM function enables you to record a 24-bit high quality sound source by converting it to a 16-bit source without reduction in sound quality. This is made possible by incorporating a noise-shaping filter in the 24-bit A/D converter of this unit, which has a frequency range designed to cover the range of human hearing.

During recording pause, press SBM. The indicator lights up.

When you press the button again, the function is canceled and the indicator turns off.

Notes

- You cannot change the setting while recording.
- When you record through the DIGITAL OPTICAL IN input, or when you make Synchro-Recording, the SBM function is automatically canceled.

Synchro-Recording a CD to CD-R or CD-RW

You can easily make digital recordings from a CD to a CD-R or CD-RW. Before recording, see “Notes on Recording” on page 16. To record a CD at high speed, see page 19.

There are 2 types of recording. Each recording type can be selected both in normal speed Synchro-Recording and High-Speed Synchro-Recording (page 19).

Normal Synchro-Recording (NORM SYNC)

- After recording, you must finalize the disc. Until the disc is properly finalized, it cannot be played on any other machine. See “Finalizing a CD-R or CD-RW” on page 24.
- A CD text contained in the disc is not automatically recorded on the disc. To label tracks/discs, see “Labeling Tracks/Discs” (page 26).

Tip

You can perform Synchro-Recording in the programmed order (page 15).

Make-Disc Synchro-Recording (MAKE DISC)

Records a CD in the original order of its track number regardless of the selected play mode, and finalizes the disc. Be sure to use the disc that has not been recorded. (“Blank Disc” appears in the display when you put the disc in DECK B.)

- A CD text (if contained in the disc) is automatically recorded. (Note that “Text Save” in Setup Menu is set to “On.”) You can enter the disc name or track name (up to 70 characters each, and 40 tracks per disc).

Tip

When you do not want to record the CD text automatically, set “Text Save” in Setup Menu to “Off.” For details, see “Using the Setup Menu” (page 28). Depending on the CDs, the CD text is automatically recorded even if “Text Save” in Setup Menu is set to “Off.”

Notes

- You cannot pause recording in Synchro-Recording.
- If Repeat Play has been set, it is automatically canceled.
- If you start the recording when Shuffle play is set, Shuffle play is automatically canceled.
- Smart Space, Auto Cut, and SBM functions do not work during Synchro-Recording.
- The recording level is set to 0.0 dB regardless of the Setup Menu setting.
- When copying a disc digitally recorded under control of the Serial Copy Management System (SCMS), the unit automatically select the analog recording. High speed recording changes to normal speed recording. For detailed explanation on SCMS, refer to the “Notes” on page 20.
- When copying a commercial music CD contains copy protection code, the unit automatically select the analog recording. High speed recording changes to normal speed recording.
- You cannot stop recording during finalizing in Make-Disc Synchro-Recording.

Normal speed Synchro-Recording

The disc is recorded at the same speed as the playing CD. You can hear the sound during recording.

When using the remote, set SELECT to CDR.

DISC 1-5 \triangle
POWER (OPEN/CLOSE for RCD-W10) OPEN/CLOSE

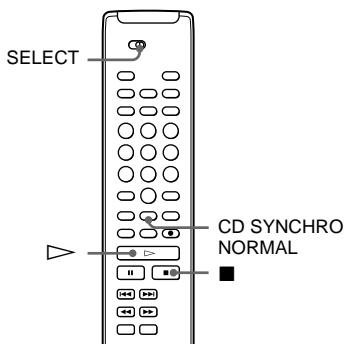
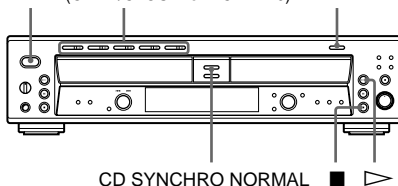

- 1 Press **POWER**.
- 2 Press **OPEN/CLOSE** of **DECK B** and place a recordable **CD-R** or **CD-RW** on the disc tray. Press **OPEN/CLOSE** of **DECK B** again to close the disc tray.

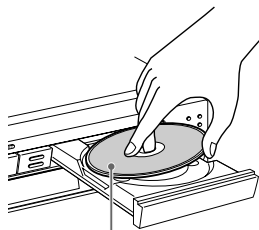

With the label side up

“TOC Reading” appears. The unit starts to read the TOC (Table of Contents) data and shows the type of the disc on the deck in the display.

- 3 Press **OPEN/CLOSE** of **DECK A** (one of the **DISC 1-5** buttons for **RCD-W50C**) and place a **CD** on the disc tray. Press **OPEN/CLOSE** (or) of **DECK A** again to close the disc tray.

When you perform Normal Synchro-Recording (**NORM SYNC**), you can choose the disc which you want to record, and the play mode.

When you perform Make-Disc Synchro-Recording (**MAKE DISC**), the disc in **DECK A** is used to record.

- 4 Press **CD SYNCHRO NORMAL** repeatedly to select the recording type, “**NORM SYNC**” or “**MAKE DISC.**” **DECK B** stands by for recording, and **DECK A** stands by for playing.*

When you place a **CD-R** or **CD-RW** in the deck, the unit optimizes itself for the best possible recording and “**OPC**” appears on the display shortly.

When “**Not Blank**” appears, make sure that the blank disc is placed correctly.

* The unit stands by for recording immediately by pressing **YES**. While “**OPC**” appears, you cannot press **YES**.

- 5 After “**New Track**” appears in the display, press (or **II**) of **DECK B** to start recording.

Synchro-Recording starts. **DECK A** and **DECK B** will automatically stop after recording.

To stop recording

Press .

High-Speed Synchro-Recording

You can easily make digital recordings from a **CD** to a **CD-R** or **CD-RW**, faster than normal speed Synchro-Recording.

You cannot monitor the recorded signal while recording.

When using the remote, set **SELECT** to **CDR**.

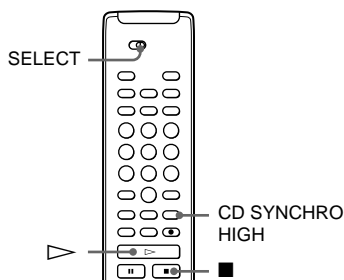
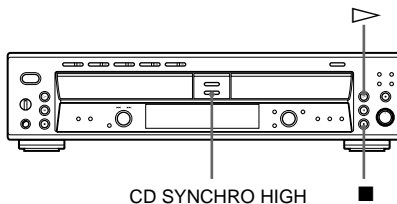

- 1 Do Steps 1 to 3 of “**Normal speed Synchro-Recording**” on page 18.

- 2 Press **CD SYNCHRO HIGH** repeatedly to select the recording type, “**NORM SYNC**” or “**MAKE DISC.**”

DECK B stands by for recording, and **DECK A** stands by for playing.*

* The unit stands by for recording immediately by pressing **YES**.

- 3 After “**New Track**” appears in the display, press (or **II**) of **DECK B** to start recording.

High-Speed Synchro-Recording starts.

DECK A and **DECK B** will automatically stop after recording.

To stop recording

Press .

Playing from the beginning of the disc after recording

- 1 Press again while the unit is stopped.

- 2 Press .

The unit starts playing from the first track.

Recording on a CD-R or CD-RW Manually

You can start recording from the end of the existing material. Before recording, see “Notes on Recording” on page 16.

When using the remote, set SELECT to CDR.

- After recording, you must finalize the disc. Until the disc is properly finalized, it cannot be played on any other machine. See “Finalizing a CD-R or CD-RW” on page 24.

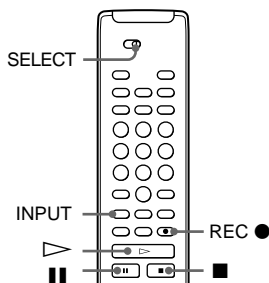
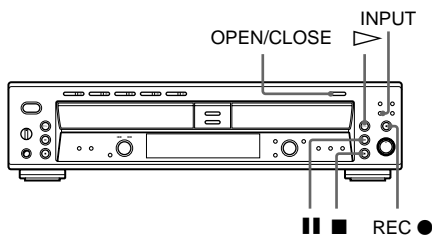

- 1 Turn on the amplifier and the sound source, and then select the sound source on the amplifier.
- 2 Press OPEN/CLOSE of DECK B and place a recordable CD-R or CD-RW on DECK B. Press OPEN/CLOSE again to close the disc tray.

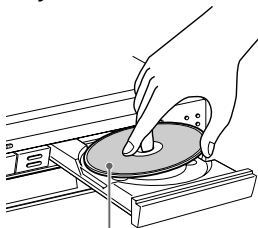

With the label side up

- 3 Press INPUT repeatedly to select the input connector.

To record through	Turn on the indicator
DIGITAL OPTICAL IN	OPTICAL
ANALOG IN	ANALOG

To record the disc in DECK A, turn off “OPTICAL” or “ANALOG.”

- 4 Press REC ●. DECK B stands by for recording.
- 5 Adjust the recording level, if necessary. For details, see “Adjusting the Recording Level” on page 21.
- 6 Press ▷.
- 7 Start playing the sound source you want to record.

To pause recording

Press |||. To resume recording, press the button again or press ▷.

Note

Whenever you pause recording, a new track number is added. For example, if you paused recording while recording on track 4, the track number increases by one and recording continues on the new track when recording is resumed.

To stop recording

Press ■.

“PMA Writing” appears while updating the information of the disc before stopping the recording.

Notes

- If you press REC ● during recording, you can add a track (page 22). The track must be longer than 4 seconds.
- This unit uses the Serial Copy Management System, which allows only first-generation digital copies to be made of premastered software via the unit’s digital input. Therefore you may not be able to record a CD-R or CD-RW digitally through OPTICAL IN, depending on the content being recorded.

Adjusting the Recording Level

Adjusting the recording level for digital recording

You can adjust the recording level using the Setup Menu. (For details of “Using the Setup Menu,” see page 28.)

When using the remote, set SELECT to CDR.

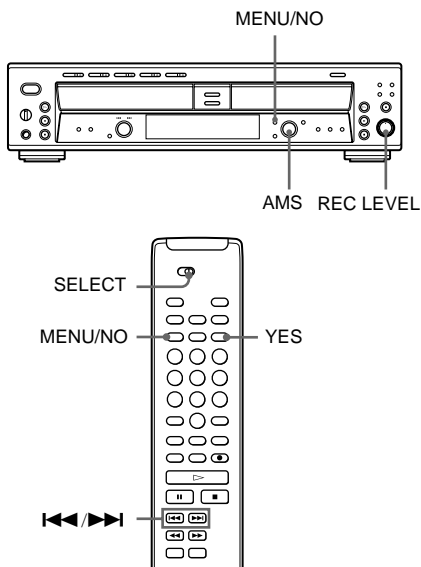

- 1 Do Steps 1 to 4 of “Recording on a CD-R or CD-RW Manually” on page 20.
- 2 Play the portion of the sound source with the strongest signal level.
- 3 Press MENU/NO.
- 4 Turn AMS (or press **◀▶** on the remote) to select the program source.

To select	Display
DECK A	DECK A Lvl
a component connected to the DIGITAL OPTICAL IN connector	Optical Lvl

- 5 Press AMS (or YES).

- 6 While monitoring the sound, turn AMS (or press **◀▶** on the remote) to adjust the recording level, then press AMS (or YES).

Adjust the recording level within a range of $-\infty$ to +18 dB, so that the OVER indication of the peak level meters does not light up in red.

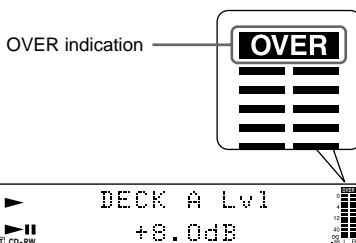

- 7 Press MENU/NO.
- 8 Stop playing the sound source.
- 9 To start recording, do Steps 6 and 7 of “Recording on a CD-R or CD-RW Manually” on page 20.

Note

You cannot change the setting of the DIGITAL OPTICAL output level even if you adjust the recording level for digital recording.

Adjusting the recording level for analog recording

Turn the REC LEVEL control on the front panel. Adjust the recording level so that the OVER indication on the peak level meters does not light up.

Note

You can adjust the recording level while recording, not while playing a disc in DECK B.

Marking Track Numbers While Recording

You can mark track numbers either manually or automatically. By marking track numbers at specific points, you can quickly locate the points later using the AMS Function or Editing Functions.

When using the remote, set SELECT to CDR.

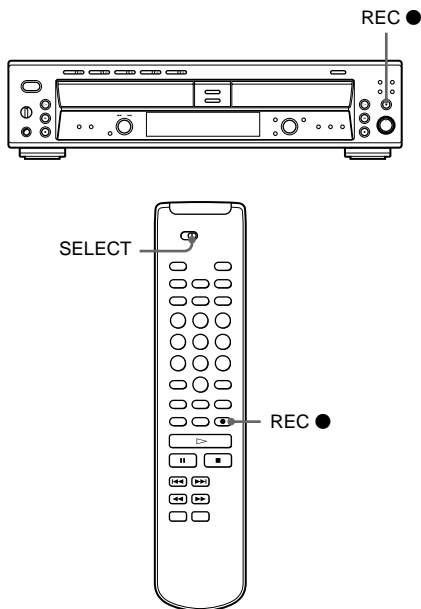

Marking track numbers manually

You can mark track numbers at any time while recording.

Press REC ● at the point you want to add a track mark while recording.

Marking track numbers automatically (Track Marking Function)

The unit adds track marks differently in the following cases:

- When you make a Synchro-Recording (page 18)
The unit marks track numbers automatically under the control of DECK A.
- When recording from a CD or MD connected through the DIGITAL OPTICAL IN connector (with "OPTICAL" selected by the INPUT button)
The unit marks track numbers automatically according to the information contained in the source being recorded. However, the unit may not automatically mark track numbers when recording from some CD players and multi disc players.
- In all other cases
When "Track Mark LSync" is set in Setup Menu, the unit marks a new track number whenever the signal drops to the specified level* or below for about 1.5 seconds or longer, then rises to a specified level.

* The initial setting is -50 dB.

To turn off the Track Mark Function
While the unit is stopped, set "Track Mark" in Setup Menu to "Off." For details, see "Using the Setup Menu" (page 28).

To change the trigger level for Track Marking Function

While the unit is stopped, select "LSync Lvl" in Setup Menu and set the level between -72 dB and -20 dB. For details, see "Using the Setup Menu" (page 28).

Recording the Original Sound of the Program Source (Direct Recording Function)

Digital signals with a sampling frequency of 44.1 kHz can be recorded without using internal circuits of the unit. You can set this function using the Setup Menu. (For details on “Using the Setup Menu,” see page 28.)

When using the remote, set SELECT to CDR.

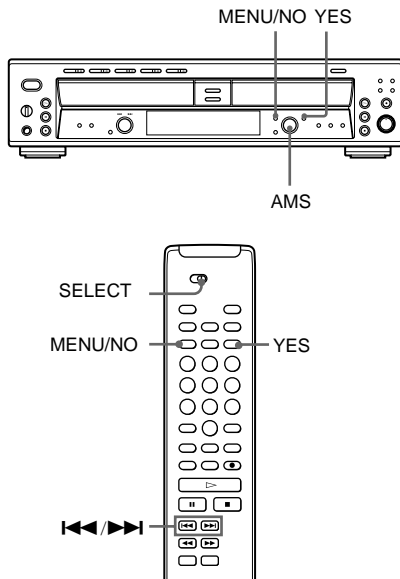

- 1 While the unit is stopped, press **MENU/NO**.
- 2 Turn **AMS** (or press **◀◀/▶▶** on the remote) to select “Direct Off,” and press **AMS** (or **YES**).
- 3 Turn **AMS** (or press **◀◀/▶▶** on the remote) to select “Direct On,” and press **AMS** (or **YES**).
- 4 Press **MENU/NO**.

Note

Digital signals with other sampling frequencies than 44.1 kHz are automatically recorded through the sampling rate converter of the unit, even when “Direct On” is selected in Setup Menu.

Fading In and Out (Fader)



You can gradually increase the recording level at the beginning of a recording (fade-in recording) or decrease the recording level at the end of a recording (fade-out recording).

This function is convenient when you do not want the track to start or end abruptly.

Before using the remote, set SELECT to CDR.

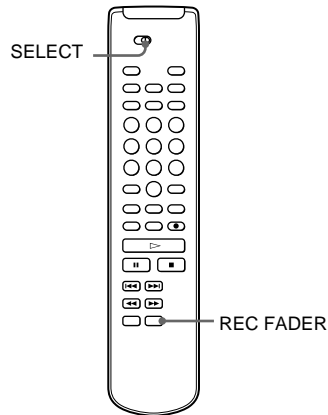

Notes

- Fading lasts for 5 seconds.
- You cannot change the setting of the DIGITAL OPTICAL output level even if you make fade-in/fade-out recording.

Fade-in recording

During recording pause, press **REC FADER** at the point where you want to start fade-in recording.

“Fade In” flashes in the display, and recording starts.

Fade-out recording

During recording, press **REC FADER** at the point where you want to start fade-out recording.

“Fade Out” flashes in the display, and the unit fades out and changes to recording pause.

Finalizing a CD-R or CD-RW

Finalizing completes the recording of a disc. It enables you to play the disc on other players. (The player must be CD-RW compatible.)

When a recording is finished, a CD-R or CD-RW must be finalized. Once that is done, a CD-R may not be added or erased to. CD-RWs are locked once they are finalized, and must be unfinalized to permit additional recording or erasure.

When using the remote, set SELECT to CDR.

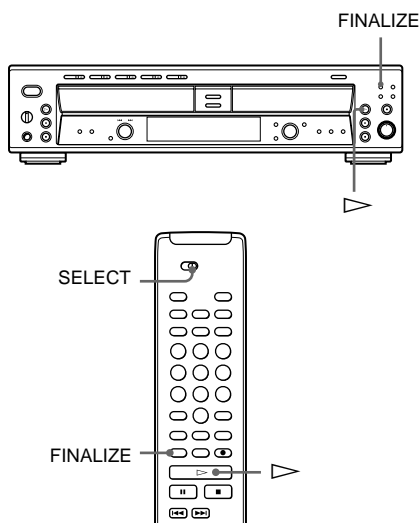

Notes

- Once the finalizing process starts, you cannot stop in the middle of the process.
- Do not turn off the unit or disconnect the unit from the power source in the middle of the finalizing process. Recording will not be complete successfully, and you will not be able to play back the recorded tracks.
- An unfinalized disc can be played back only in DECK B.

1 Place a CD-R or CD-RW that has not been finalized in DECK B.

Make sure that "TOC" appears in the display. If a finalized CD is loaded, "TOC" does not appear.

2 Press FINALIZE while the unit is stopped.

Finalizing enters standby mode.

3 Press ▷ (or YES).

Finalizing starts. During finalizing, "Finalize" appears in the display and the remaining time for finalizing (may not be accurate) appears. When the finalizing process is finished, the total track number and total playing time appears in the display and the TOC (red) indicator goes off.

Unfinalizing a CD-RW

A finalized CD-RW is neither recordable nor rewritable. If you want to add new tracks or erase tracks, you must first unfinalize the disc.

When using the remote, set SELECT to CDR.

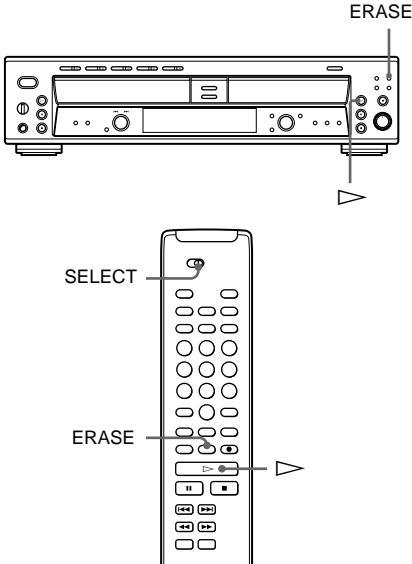

1 Place a finalized CD-RW in DECK B.

Make sure that “TOC” does not appear in the display. If an unfinalized CD is loaded, “TOC” appears.

2 Press ERASE while the unit is stopped.

Unfinalizing enters standby mode.

3 Press \blacktriangleright (or YES).

Unfinalizing starts. During unfinalizing, “Unfinalize” appears in the display and the remaining time for unfinalizing (may not be accurate) appears. When the unfinalizing process is finished, the total track number and the total playing time appears in the display and the TOC (red) indicator lights up.

Notes

- Once the unfinalizing process was started, you cannot stop in the middle of the process.
- Do not turn off the unit or disconnect the unit from the power source in the middle of the unfinalizing process.

Erasing Tracks of a CD-RW

You can erase tracks recorded on a CD-RW. This process starts with the last track on the disc.

Before erasing the track, note that the disc is not finalized. If the disc is finalized, follow the instructions for “Unfinalizing a CD-RW” (page 25).

When using the remote, set SELECT to CDR.

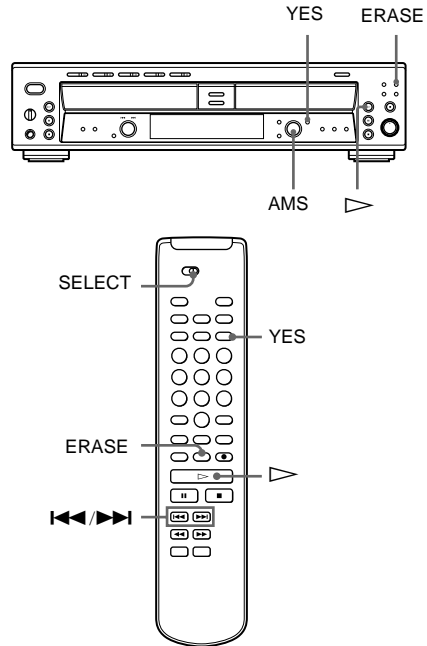

1 Place an unfinalized CD-RW disc in DECK B.

Make sure that “TOC” appears in the display. If a finalized CD is loaded, “TOC” does not appear.

2 Press ERASE while the unit is stopped.

“Tr Erase?” appears in the display.

3 Press YES.

The last track is selected.

To erase only the last track, go to step 5.

4 Turn AMS (or press **◀◀/▶▶** on the remote) to select the first of the tracks you want to erase.

5 Press **▷** (or YES).

Erasing of the last track starts. During erasing, “Tr Erase” appears in the display and the remaining time for erasing the last track (may not be accurate) appears. When this process is finished, the total track number and the total playing time appears in the display.

To erase all tracks

1 Place an unfinalized CD-RW disc in DECK B.

2 Press ERASE repeatedly until “Disc Erase?” appears in the display while the unit is stopped.

3 Press **▷** (or YES).

Erasing starts. During erasing, “Disc Erase” appears in the display and the remaining time of erasing (may not be accurate) appears. When the entire disc is erased, “Blank Disc” appears.

Notes

- Once the erasing process has started, you cannot stop in the middle of the process.
- You can erase only from the last track.
- Do not turn off the unit or disconnect the unit from the power source in the middle of the erasing process.

Labeling Tracks/Discs

You can create titles for tracks/discs for a recorded CD-R or CD-RW with capital and small letters, numbers, and symbols. You can enter a disc name of up to 70 characters, and a track name of up to 70 characters per track, for 40 tracks per disc.

Label the track/disc before finalizing it. You cannot label the track/disc on a finalized disc.

After labeling, you must finalize the disc before you remove the disc or turn off the unit.

Otherwise, the titles will be cleared.

When using the remote, set SELECT to CDR.

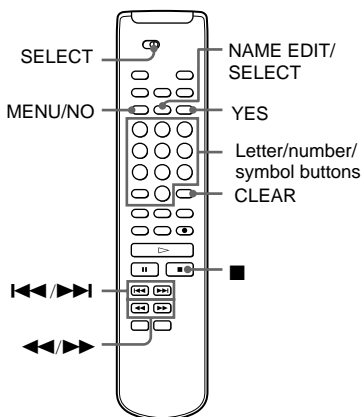

1 Place a CD-R or CD-RW disc that has not been finalized in DECK B.

2 Press NAME EDIT/SELECT while the unit is stopped.

“Name In?” appears in the display.

3 Press YES.

4 Press **◀◀/▶▶** to select the disc or track you want to label.

When you label the disc name, select “Disc,” and when you label the track name, select the track number.

5 Press YES.

A flashing cursor appears.

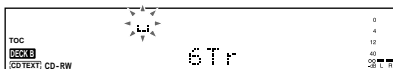

6 Press NAME EDIT/SELECT repeatedly to select the character type as follows:

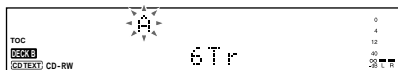

To select	Display
Capital letters and symbols*	Selected AB
Small letters and symbols*	Selected ab
Numbers	Selected 12

* You can use the following symbols in titles:
' - / , . () : ! ? & + < > _ = " ; # \$ % @ * ^`
To enter a space, press 10/0.

7 Press a letter/number/symbol button to enter a character.

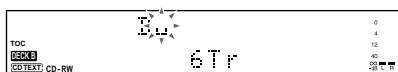

To enter a number, press the number button you want.

To enter a letter or symbol,

1 Press the corresponding letter button repeatedly until the letter or symbol you want flashes. You can also enter a letter or symbol by pressing **◀◀/▶▶** repeatedly. To select the symbol, press **▶▶** repeatedly after flashing “.”.

2 Press **▶▶**.

8 Repeat Steps 6 and 7 until you have entered the entire title.

If you enter an incorrect character, press **◀◀** or **▶▶** until the incorrect character starts flashing.

Press **CLEAR** to erase the incorrect character, then enter the correct one.

9 Press YES.

“Complete !” appears in the display for a few seconds and the track or disc is labeled. Finalize the disc before you remove the disc or turn off the unit. Otherwise, the titles will be cleared.

To cancel labeling
Press **MENU/NO** or **■**.

Changing an existing title

1 Do Steps 1 to 5 in “Labeling Tracks/ Discs” (page 26) to select the title you want to change.

2 Press and hold **CLEAR** until the current title is erased.

3 Do Steps 6 to 8 of “Labeling Tracks/ Discs” (page 26) to enter the new title.

4 Press **YES**.

“Complete !” appears in the display for a few seconds and the track or disc is labeled.

Using the Setup Menu

You can make various settings on this unit by using the Setup Menu.

When using the remote, set SELECT to CDR.

- 1 Press **MENU/NO**.
- 2 Turn **AMS** (or press **◀◀/▶▶** on the remote) to select the setup item, and press **AMS** (or **YES**).
- 3 Turn **AMS** (or press **◀◀/▶▶** on the remote) to set the item, and press **AMS** (or **YES**).
- 4 Press **MENU/NO**.

To initialize an item's parameter
Press **CLEAR** after Step 2.

Notes

- The menus you can use while the unit is stopped, playing, or recording differ.
- The setting is stored in memory even if you turn off the unit or disconnect the power.

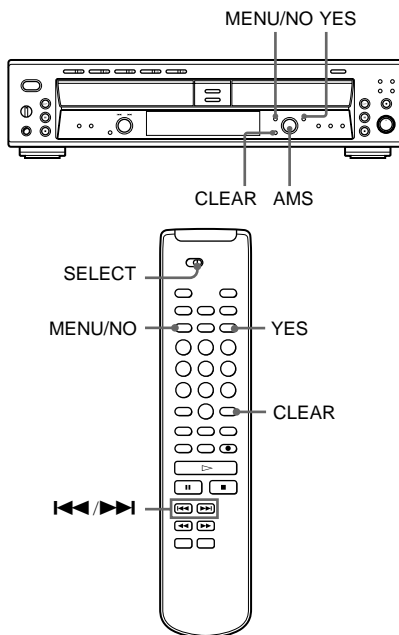

Menu items

Setup item	Function (reference page)	Parameters (Initial setting)
Track Mark	Sets the Track Marking Function (page 22).	LSync/Off (LSync)
LSync Lvl	Changes the trigger level for Track Marking Function (page 22).	-72 dB to -20 dB in 2 dB increments (-50 dB)
Smart Space	Sets the Smart Space and Auto Cut Functions (page 17).	On/Off (On)
Direct	Sets the Direct Recording Function (page 23).	On/Off (Off)
Text Save	Records the CD text automatically at Make-Disc Synchronous Recording (page 18).	On/Off (On)
Post Gap	Sets the function to add Post Gap. (page 17).	On/Off (Off)
DECK A Lvl	Adjusts the input level from the CD player section (DECK A) (page 21).	-∞ dB to 18.0 dB (0.0 dB)
Optical Lvl	Adjusts the input level from the DIGITAL OPTICAL IN connector (page 21).	-∞ dB to 18.0 dB (0.0 dB)

Messages

The following table explains the messages that appear in the display.

Message	Explanation
Auto Cut	The Auto Cut function is operating.
Blank Disc	A blank CD-R/CD-RW you have just bought or a CD-RW you have entirely erased is in the unit.
Check Disc	You are trying to record or edit a finalized disc or CD. Or you are trying to edit a CD-R.
Complete!	Editing has been completed successfully.
Data Disc	You are trying to record or edit a non audio CD-R/CD-RW. • Insert an audio CD-R/CD-RW.
Disc Full!	There is not enough time left on the CD-R/CD-RW or there are no recordable tracks available to complete a planned recording.
Erase	The ERASE function is operating.
Ex-Change (RCD-W50C only)	During CD playback, you remove and insert another CD.
Fade In	The FADE IN REC function is operating.
Fade Out	The FADE OUT REC function is operating.
Finalize	The FINALIZE function is operating.
Incomplete!	Editing has not completed successfully due to vibration of the unit or a dirty or scratched disc.
Initialize	The unit does not memorize the Setup Menu settings or the previous playback state.
Name Full!	The number of characters used for the track or disc names is beyond the maximum.
-NO DISC-	There is no disc in the unit.
No Name	There is no title.

Message	Explanation
Not Blank	You have tried the MAKE DISC Synchro-Recording, with a disc that is not blank. • Use a blank disc for the MAKE DISC Synchro-Recording.
OPC	OPC: Optimum Power Control The unit is optimizing itself for best possible sound.
OPC Over	The number of times OPC recording has been performed 90 times. • Stop the recording and finalize the disc.
-Over-	The playback of the last track is over. • Turn the AMS dial counterclockwise (or press ◀◀ or ◀◀ on the remote).
PMA Writing	PMA: Program Memory Area A disc's information is being updated.
Push STOP!	You operate the unit not in the STOP mode. • Stop the unit, and then operate the unit again.
-Retry-	Recording or editing has been tried again.
Smart Space	The Smart Space function is operating.
Step Full!	The number of programmed tracks has reached the limit, and you cannot program any more tracks. • Before you program a new track, erase the current program and restart a new program procedure.
TEXT Edited	A disc whose text has been edited but has not been finalized is inserted, and OPEN/CLOSE (or ⏏) has been pressed. • Finalize the disc, and then press OPEN/CLOSE (or ⏏) to remove the disc. If you want to remove the disc before finalizing it, press OPEN/CLOSE (or ⏏) again while "TEXT Edited" is displayed.
Unfinalize	The UNFINALIZE function is operating.

Self-diagnosis Function

When the self-diagnosis function is activated to prevent the player from malfunctioning, three character service numbers in a combination with a message appears in the display. In this case, check the following table.

Message	Explanation
C12/ Cannot Copy	<p>You are trying to record a disc that cannot be played back in DECK-A or with an external device, such as CD-ROM or VIDEO CD.</p> <ul style="list-style-type: none">• Remove the disc, and then insert a music CD for playback.
C13/ Rec Error	<p>Recording has not been completed successfully because of vibration.</p> <ul style="list-style-type: none">• Relocate the unit in a place free of vibration and restart the recording again. <p>The disc you try to record is excessively dirty (such as oil-stained or finger marked) or scratched. Or the disc is not normal.</p> <ul style="list-style-type: none">• Replace the disc with another one and restart the recording again.
C14/ TOC Error	<p>The unit did not read the TOC information.</p> <ul style="list-style-type: none">• Insert other discs.
C41/ Cannot Copy	<p>The sound source you are trying to record is a copy of a commercial music software. Or you are trying to record on a CD-R/CD-RW digitally.</p> <ul style="list-style-type: none">• Because of the restriction of the Serial Copy Management System, you cannot record a copy of a commercial music software. Neither can you record a CD-R/CD-RW digitally.
C71/ Din Unlock	<p>If this message is displayed momentarily, this is not an error. It is caused by the digital signal during recording.</p> <p>During recording of a digital sound source, the connecting cable has been disconnected or the player of the sound source has turned off.</p> <ul style="list-style-type: none">• Connect the cable or turn on the digital player.

System Limitations

“TOC Reading” appears in the display for a long time

Regardless of the disc, “TOC Reading” appears in the display of DECK B longer than in that of DECK A. This is because, DECK B is a CD-R/RW writer and reads various version information while setting optimum recording condition.

Limitations when recording over an existing track

- The correct remaining recording time may not be displayed.
- The remaining recording time may be inaccurately displayed relative to the total recorded time.
- You can record up to 99 tracks.

Note

When you turn on the unit, you will hear some mechanical noise from the unit. This is not a malfunction.

Troubleshooting

If you experience any of the following difficulties while using the unit, use this troubleshooting guide to help you remedy the problem.

DECK A (the CD player section)

The player does not start playing.

- Insert a disc.
- Place the disc properly.
- Clean the disc (page 4).
- Place the disc with the label side up.
- Moisture condensation has formed inside the unit. Take the disc out and leave the unit turned on for about an hour until the moisture evaporates (page 4).
- Press POWER to turn the unit on.

DECK B (the CD-R and CD-RW recording section)

The unit does not operate or operates poorly.

- The CD-R or CD-RW may be damaged. Replace the disc.

The unit does not play back.

- Place the CD-R or CD-RW with the label side up.
- Moisture has formed inside the unit. Take the disc out and leave the unit in a warm place for several hours until the moisture evaporates (page 4).
- Press POWER to turn the unit on.
- Replace the CD-R or CD-RW with one that has been recorded.

The unit does not record.

- The CD-R or CD-RW is finalized. Unfinalize (for CD-RW only) the disc (page 25) and try again.
- Make connections properly to the sound source (page 6).
- The sound source is not connected to the selected input connector. Select the correct input using the INPUT button (page 20).
- The recording level is set too low. Adjust the recording level properly (page 21).
- There has been a power failure or the AC power cord has been disconnected during recording. Data recorded to that point may be lost.

The sound has a lot of static.

Strong magnetism from a television or a similar device is interfering with operations. Move the unit away from any sources of strong magnetism.

Other

No sound is output.

- Make the connections properly (page 6).
- Operate the amplifier properly.
- When using the headphones, turn PHONE LEVEL to turn up the output level.

The remote does not operate the unit.

- Make sure that there are no obstacles between the unit and the remote.
- Point the remote at the remote sensor on the unit.
- Replace the batteries in the remote.

When you turn on the unit, you will hear some mechanical noise from the unit. This is not a malfunction.

After you have attempted the prescribed corrective actions

If the unit still does not operate properly, or if other problems not described above occur, turn off the unit, then reinsert the plug into the power outlet.

Should any problem persist even after reinserting the power plug, consult your nearest Sony dealer.

Specifications

DECK A (the CD player section)

System	Compact disc digital audio system
Laser	Semiconductor laser ($\lambda = 780 \text{ nm}$) Emission duration: continuous
Frequency response	20 Hz – 20,000 Hz ($\pm 0.5 \text{ dB}$)

DECK B (the CD-R and CD-RW recording section)

System	Compact disc digital audio system
Laser	Semiconductor laser ($\lambda = 780 \text{ nm}$) Emission duration: continuous
Playable discs	CD, CD-R, CD-RW
Recordable discs	CD-R, CD-RW (for music use)
Frequency response	20 Hz - 20,000 Hz ($\pm 0.5 \text{ dB}$)

Inputs

ANALOG IN (Phono jacks)	Impedance: 47 kilohms Rated input: 500 mVrms Minimum input: 250 mVrms
----------------------------	---

DIGITAL OPTICAL IN (Square optical connector jack)	Optical wavelength: 660 nm
---	----------------------------

Outputs

ANALOG OUT (Phono jacks)	Impedance: 47 kilohms Rated output: 2 Vrms Load impedance: over 10 kilohms
-----------------------------	--

DIGITAL OPTICAL OUT (Square optical connector jack)	Wavelength: 660 nm Output level: -18 dBm
--	---

PHONES (Phono jack)	Load impedance: 32 ohms Output level: 12mW
------------------------	---

General

Power requirements	
North American model:	120 V AC, 60 Hz
Mexican model:	120 V AC, 60 Hz
Other models:	110-120/220-240V AC, 50/60 Hz
Power consumption	25 W
Dimensions (approx.) (w/h/d) incl. projecting parts and control	430 × 108 × 399 mm (17 × 4 ³ / ₈ × 15 ³ / ₄ inch)
Mass (approx.)	RCD-W50C: 6.8 kg (15 lbs) RCD-W10: 6.0 kg (13 lbs 4 oz)

Supplied accessories See page 6.

Design and specifications are subject to change without notice.