

TFT LCD Color Computer Display

Operating Instructions _____

SDM-P82

Owner's Record

The model and serial numbers are located at the rear of the unit. Record these numbers in the spaces provided below. Refer to them whenever you call upon your dealer regarding this product.

Model No. _____ Serial No. _____

WARNING

To prevent fire or shock hazard, do not expose the unit to rain or moisture.

Dangerously high voltages are present inside the unit. Do not open the cabinet. Refer servicing to qualified personnel only.

FCC Notice

This equipment has been tested and found to comply with the limits for a Class B digital device, pursuant to Part 15 of the FCC Rules. These limits are designed to provide reasonable protection against harmful interference in a residential installation. This equipment generates, uses, and can radiate radio frequency energy and, if not installed and used in accordance with the instructions, may cause harmful interference to radio communications. However, there is no guarantee that interference will not occur in a particular installation. If this equipment does cause harmful interference to radio or television reception, which can be determined by turning the equipment off and on, the user is encouraged to try to correct the interference by one or more of the following measures:

- Reorient or relocate the receiving antenna.
 - Increase the separation between the equipment and receiver.
 - Connect the equipment into an outlet on a circuit different from that to which the receiver is connected.
 - Consult the dealer or an experienced radio/TV technician for help.
- You are cautioned that any changes or modifications not expressly approved in this manual could void your authority to operate this equipment.

If you have any questions about this product, you may call:
Sony Customer Information Center
1-800-222-SONY (7669)
or write to:
Sony Customer Information Center
1 Sony Drive, Mail Drop #T1-11, Park Ridge, NJ 07656

Declaration of Conformity

Trade Name: SONY
Model No.: SDM-P82
Responsible Party: Sony Electronics Inc.
Address: 680 Kinderkamack Road, Oradell, NJ 07649
USA
Telephone No.: 201-930-6972

This device complies with Part 15 of the FCC Rules. Operation is subject to the following two conditions: (1) This device may not cause harmful interference, and (2) this device must accept any interference received, including interference that may cause undesired operation.

NOTICE

This notice is applicable for USA/Canada only. If shipped to USA/Canada, install only a UL LISTED/CSA LABELLED power supply cord meeting the following specifications:

SPECIFICATIONS

Plug Type	Nema-Plug 5-15p
Cord	Type SVT or SJT, minimum 3 x 18 AWG
Length	Maximum 15 feet
Rating	Minimum 7 A, 125 V

NOTICE

Cette notice s'applique aux Etats-Unis et au Canada uniquement.

Si cet appareil est exporté aux Etats-Unis ou au Canada, utiliser le cordon d'alimentation portant la mention UL LISTED/CSA LABELLED et remplissant les conditions suivantes:

SPECIFICATIONS

Type de fiche	Fiche Nema 5-15 broches
Cordon	Type SVT ou SJT, minimum 3 x 18 AWG
Longueur	Maximum 15 pieds
Tension	Minimum 7 A, 125 V



As an ENERGY STAR Partner, Sony Corporation has determined that this product meets the ENERGY STAR guidelines for energy efficiency.



This monitor complies with the TCO'95 guidelines.

Table of Contents

Precautions	4
Identifying parts and controls	5
Setup	7
Setup 1: Connect a computer equipped with the DVI output connector (digital RGB)	7
Setup 2: Connect a computer equipped with the HD15 output connector (analog RGB)	7
Setup 3: Connect the power cord	8
Setup 4: Bundle the cords and cables	9
Setup 5: Turn on the monitor and computer	9
Setup 6: Adjusting the tilt	10
Selecting the input signal (INPUT button)	11
Customizing Your Monitor	11
Navigating the menu	11
:☐ BACKLIGHT	12
● CONTRAST	12
☀ BRIGHTNESS	12
▲ SCREEN (analog RGB signal only)	12
☐ COLOR	14
γ GAMMA	15
☒ ZOOM	15
↔ SMOOTHING	15
Additional settings	16
Technical Features	17
Power saving function	17
Reducing the power consumption (ECO mode)	17
Automatic picture quality adjustment function (analog RGB signal only)	17
Troubleshooting	18
On-screen messages	18
Trouble symptoms and remedies	19
Self-diagnosis function	21
Specifications	21
TCO'95 Eco-document	i

- Macintosh is a trademark licensed to Apple Computer, Inc., registered in the U.S.A. and other countries.
- Windows® is registered trademark of Microsoft Corporation in the United States and other countries.
- IBM PC/AT and VGA are registered trademarks of IBM Corporation of the U.S.A.
- VESA and DDC™ are trademarks of the Video Electronics Standards Association.
- ENERGY STAR is a U.S. registered mark.
- All other product names mentioned herein may be the trademarks or registered trademarks of their respective companies.
- Furthermore, “™” and “®” are not mentioned in each case in this manual.

Precautions

Warning on power connections

- Use the supplied power cord. If you use a different power cord, be sure that it is compatible with your local power supply.

For the customers in the U.S.A.

If you do not use the appropriate cord, this monitor will not conform to mandatory FCC standards.

For the customers in the UK

If you use the monitor in the UK, be sure to use the appropriate UK power cord.

Example of plug types

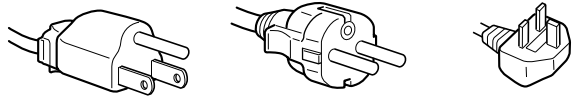

for 100 to 120 V AC for 200 to 240 V AC for 240 V AC only

The equipment should be installed near an easily accessible outlet.

Installation

Do not install or leave the monitor:

- In places subject to extreme temperatures, for example near a radiator, heating vent, or in direct sunlight. Subjecting the monitor to extreme temperatures, such as in an automobile parked in direct sunlight or near a heating vent, could cause deformations of the casing or malfunctions.
- In places subject to mechanical vibration or shock.
- Near any equipment that generates a strong magnetic field, such as a TV or various other household appliances.
- In places subject to inordinate amounts of dust, dirt, or sand, for example near an open window or an outdoor exit. If setting up temporarily in an outdoor environment, be sure to take adequate precautions against airborne dust and dirt. Otherwise irreparable malfunctions could occur.

Handling the LCD screen

- Do not leave the LCD screen facing the sun as it can damage the LCD screen. Take care when you place the monitor by a window.
- Do not push on or scratch the LCD screen. Do not place a heavy object on the LCD screen. This may cause the screen to lose uniformity or cause LCD panel malfunctions.
- If the monitor is used in a cold place, a residual image may appear on the screen. This is not a malfunction. The screen returns to normal as the temperature rises to a normal operating level.
- If a still picture is displayed for a long time, a residual image may appear for a while. The residual image will eventually disappear.
- The LCD panel becomes warm during operation. This is not a malfunction.

Note on the LCD (Liquid Crystal Display)

Please note that the LCD screen is made with high-precision technology. However, black points or bright points of light (red, blue, or green) may appear constantly on the LCD screen, and irregular colored stripes or brightness may appear on the LCD screen. This is not malfunction.

(Effective dots: more than 99.99%)

Replacement of the fluorescent tube

A specially designed fluorescent tube is installed as the lighting apparatus for this monitor. If the screen becomes dark, unstable, or does not turn on, replace the fluorescent tube with a new one. Consult your Sony dealer when replacing the fluorescent tube.

Maintenance

- Be sure to unplug the power cord from the power outlet before cleaning your monitor.
- Clean the LCD screen with a soft cloth. If you use a glass cleaning liquid, do not use any type of cleaner containing an anti-static solution or similar additive as this may scratch the LCD screen's coating.
- Clean the cabinet, panel, and controls with a soft cloth lightly moistened with a mild detergent solution. Do not use any type of abrasive pad, scouring powder, or solvent, such as alcohol or benzene.
- Do not rub, touch, or tap the surface of the screen with sharp or abrasive items such as a ballpoint pen or screwdriver. This type of contact may result in a scratched picture tube.
- Note that material deterioration or LCD screen coating degradation may occur if the monitor is exposed to volatile solvents such as insecticide, or if prolonged contact is maintained with rubber or vinyl materials.

Transportation

- Disconnect all cables from the monitor and grasp the support and base sections of the display stand firmly with both hands when transporting. If you drop the monitor, you may be injured or the monitor may be damaged.
- When you transport this monitor for repair or shipment, use the original carton and packing materials.

Disposal of the monitor

- **Do not dispose of this monitor with general household waste.**
- **The fluorescent tube used in this monitor contains mercury. Disposal of this monitor must be carried out in accordance to the regulations of your local sanitation authority.**

Identifying parts and controls

See the pages in parentheses for further details.

Front of the LCD display

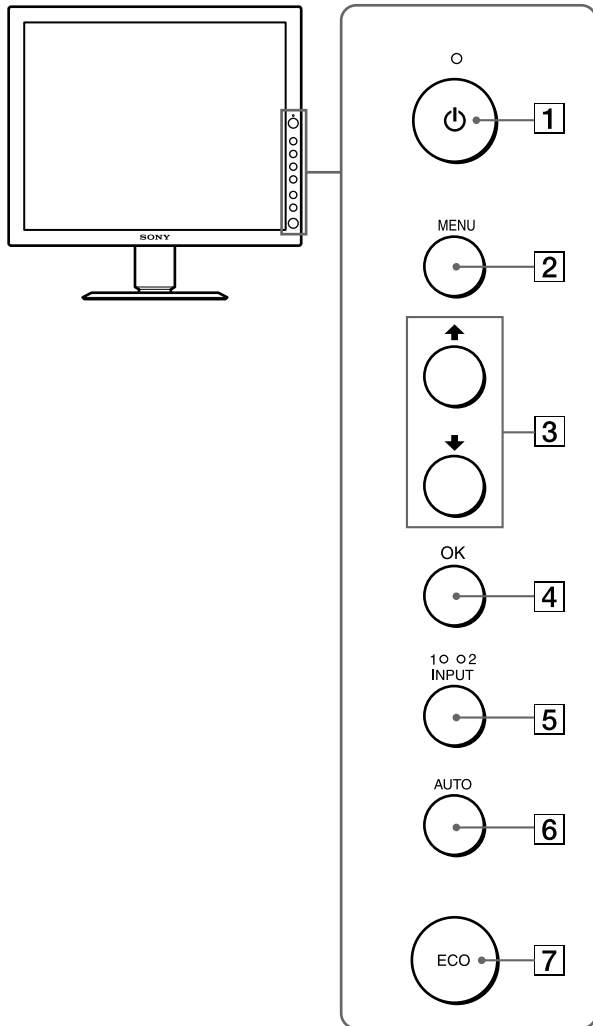

Side view of the LCD display

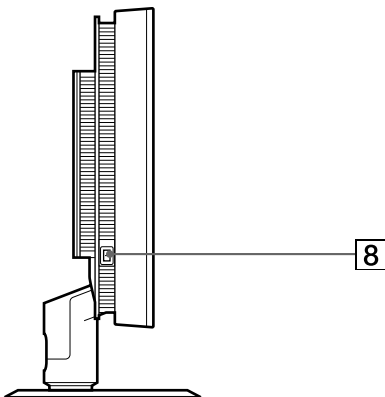

Rear of the display stand

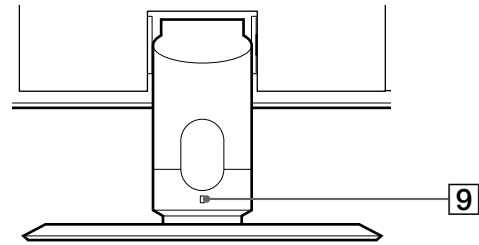

1 (Power) switch and (Power) indicator (pages 9, 17, 21)

This switch turns the monitor on when the (power) indicator lights up in red. To turn the monitor off, press this switch again.

If the (power) indicator does not light up, press the MAIN POWER switch (8).

2 MENU button (page 11)

This button turns the menu screen on and off.

3 buttons (page 11)

These buttons are used to select the menu items and make adjustments.

4 OK button (page 11)

This button activates the selected menu item and adjustments using with buttons (3).

5 INPUT button and INPUT1/INPUT2 indicator (page 11)

This button selects the connected computer for switching the video input signals, and the corresponding indicator, (INPUT1 or INPUT2) lights up.

6 AUTO button (page 12)

Press this button when the displayed picture seems poorly adjusted. It makes further automatic adjustment of the picture quality for the current input signal.

7 ECO button (page 17)

This button is used to reduce the power consumption.

8 MAIN POWER switch (page 9)

This switch turns the monitor's main power on and off.

9 Security Lock Hole

The security lock hole should be applied with the Kensington Micro Saver Security System.

Micro Saver Security System is a trademark of Kensington.

US

(continued)

Rear of the LCD display

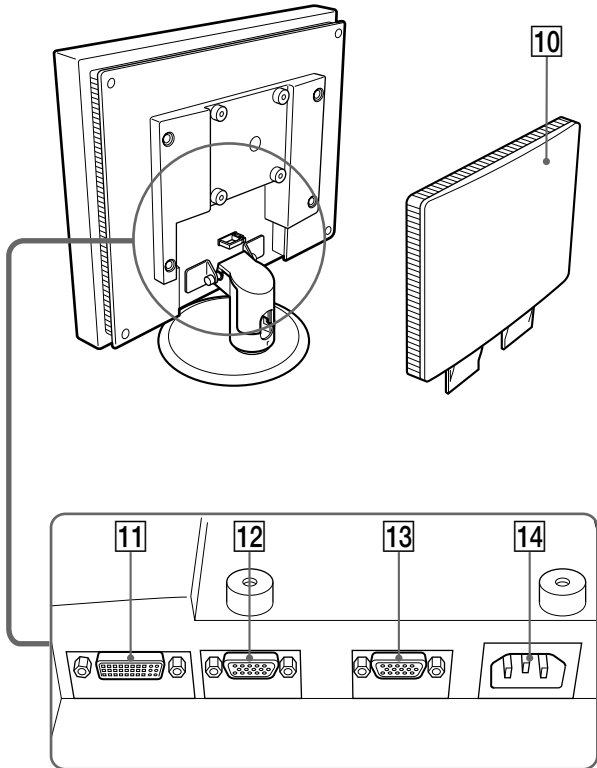

10 Back cover (page 7)

Remove this cover when you connect cables or cords.

11 DVI-D input connector (digital RGB) for INPUT1 (page 7)

This connector inputs digital RGB video signals that comply with DVI Rev. 1.0.

12 HD15 input connector (analog RGB) for INPUT1 (page 7)

This connector inputs analog RGB video signals (0.700 Vp-p, positive) and sync signals.

13 HD15 input connector (analog RGB) for INPUT2 (page 7)

This connector inputs analog RGB video signals (0.700 Vp-p, positive) and sync signals.

14 AC IN connector (page 8)

Connect the power cord (supplied).

15 Arm cover (page 9)

Remove this cover to bundle connecting cords and cables.

16 Cable holder (page 9)

This part secures cables and cords to the monitor.

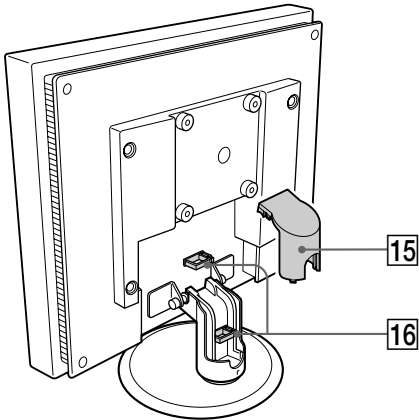

Setup

Before using your monitor, check that the following items are included in your carton:

- LCD display
- Power cord
- HD15-HD15 video signal cable (analog RGB)
- DVI-D video signal cable (digital RGB)
- Windows Utility/Macintosh Utility Disk
- Warranty card
- This instruction manual

Setup 1: Connect a computer equipped with the DVI output connector (digital RGB)

- Turn off the monitor and computer before connecting.
- When connecting the computer to the monitor's HD15 input connector (analog RGB), refer to "Setup 2: Connect a computer equipped with the HD15 output connector (analog RGB)."

Note

Do not touch the pins of the video signal cable connector as this might bend the pins.

1 Remove the back cover.

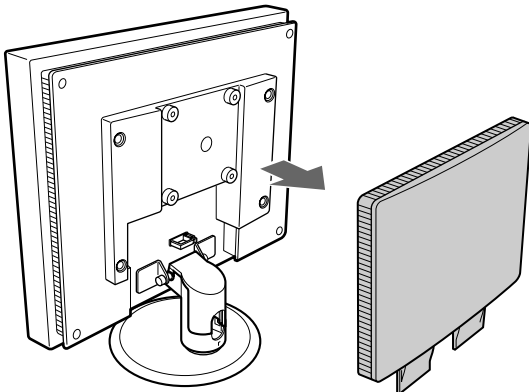

2 Using the supplied DVI-D video signal cable (digital RGB), connect the computer to the monitor's DVI-D input connector (digital RGB) for INPUT1.

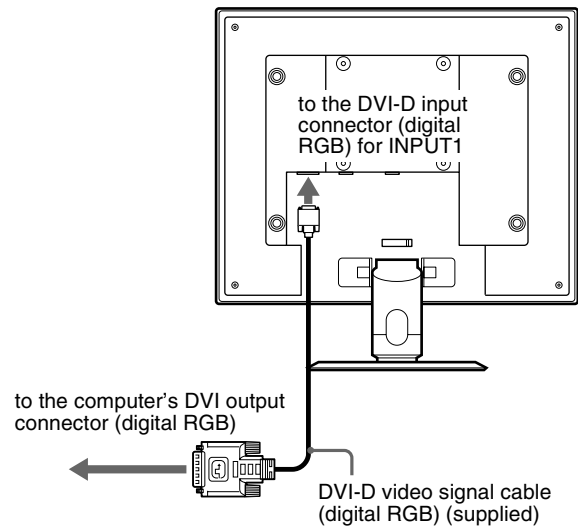

Setup 2: Connect a computer equipped with the HD15 output connector (analog RGB)

US

Turn off the monitor and computer before connecting.

Note

Do not touch the pins of the video signal cable connector as this might bend the pins.

1 Remove the back cover.

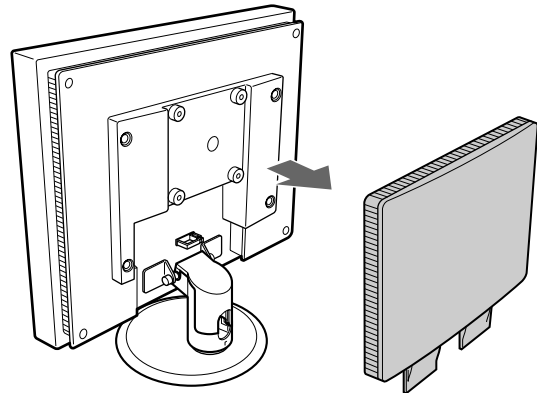

(continued)

- Using the supplied HD15-HD15 video signal cable (analog RGB), connect the computer to the monitor's HD 15 input connector (analog RGB) for INPUT 1 or INPUT2.

Connect the computer according to the following illustrations.

■ Connecting to an IBM PC/AT or compatible computer

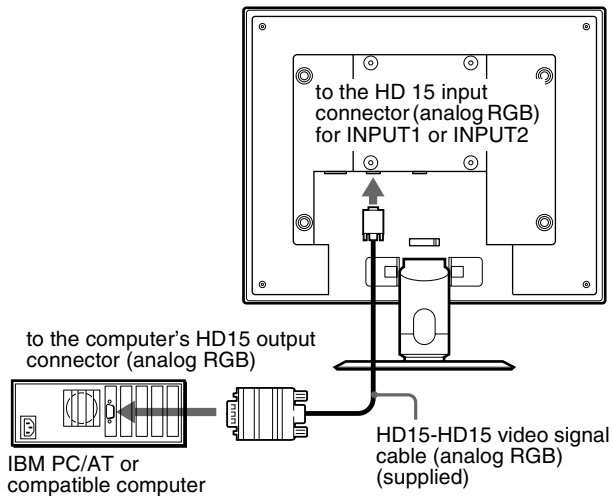

■ Connecting to a Macintosh

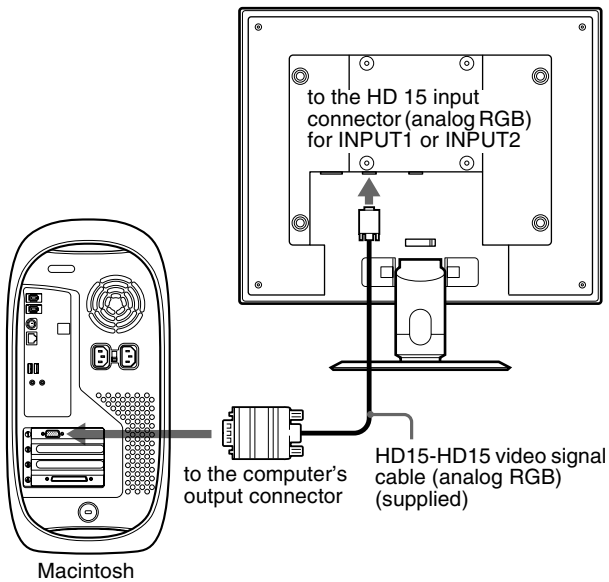

When connecting a Macintosh computer, use an adapter (not supplied) if necessary. Connect the adapter to the computer before connecting the video signal cable.

Setup 3: Connect the power cord

- Connect the supplied power cord to the monitor's AC IN connector.
- Connect it to a power outlet.

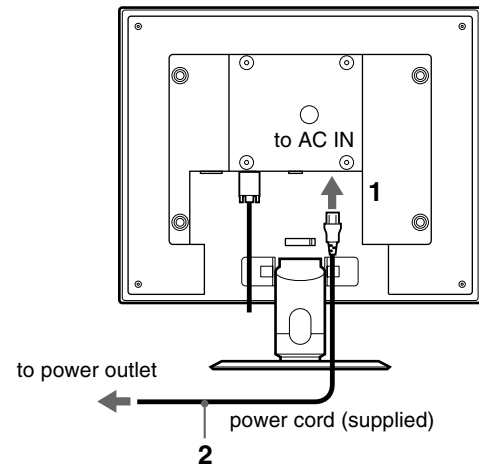

Setup 4: Bundle the cords and cables

- 1 Remove the arm cover.
- 2 Bundle the cords and cables inside of the stand.
- 3 Secure the cables and cords with the cable holder.
- 4 Replace the arm cover and back cover.

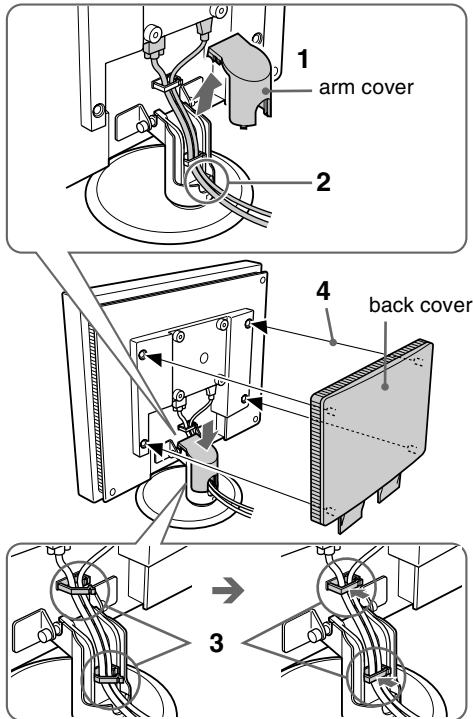



Note

If you cannot bundle all of the cords and cables inside the stand, leave them hanging down outside the stand.

Setup 5: Turn on the monitor and computer

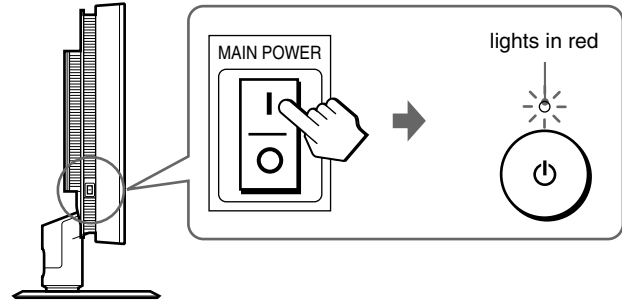
- 1 Press the **MAIN POWER** switch on the left side of the monitor in the direction of I.
The  (power) indicator lights up in red.



- 2 Press the  (power) switch on the front right of the monitor.
The  (power) indicator lights up in green.

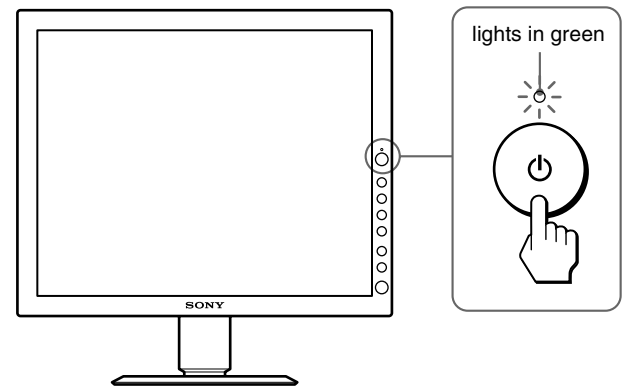

US

- 3 Turn on the computer.
- 4 Press the **INPUT** button repeatedly and select the desired input signal.
The selected input signal indicator lights up and the picture appears on the screen.
For more information, see “Selecting the input signal (INPUT button)” on page 11.

1 0 0 2
INPUT



The installation of your monitor is complete. If necessary, use the monitor's controls to adjust the picture (page 11).

(continued)

If no picture appears on your screen

- Check that the power cord and the video signal cable are properly connected.
- If NO INPUT SIGNAL appears on the screen:
 - The computer is in the power saving mode. Try pressing any key on the keyboard or moving the mouse.
 - Check that the input signal setting is correct by pressing the INPUT button repeatedly (page 11).
- If CABLE DISCONNECTED appears on the screen:
 - Check that the video signal cable is properly connected.
 - Check that the input signal setting is correct by pressing the INPUT button repeatedly (page 11).
- If OUT OF SCAN RANGE appears on the screen, reconnect the old monitor. Then adjust the computer's graphics board in the following ranges.

Horizontal frequency	28 – 92 kHz
Vertical frequency	56 – 85 Hz
Resolution	1280 × 1024 or less

For more information about on-screen messages, see “Trouble symptoms and remedies” on page 19.

No need for specific drivers

The monitor complies with the “DDC” Plug & Play standard and automatically detects all the monitor's information. No specific driver needs to be installed to the computer.

The first time you turn on your computer after connecting the monitor, the setup Wizard may appear on the screen. In this case, follow the on-screen instructions. The Plug & Play monitor is automatically selected so that you can use this monitor.

The vertical frequency turns to 60 Hz.

Since flickers are unobtrusive on the monitor, you can use it as it is. You do not need to set the vertical frequency to any particular high value.

Setup 6: Adjusting the tilt

This monitor can be adjusted within the angles shown below.

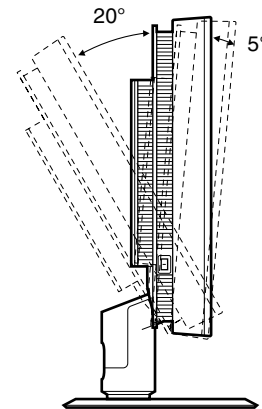

To use the monitor comfortably

Adjust the viewing angle of your monitor according to the height of your desk and chair, and so that light is not reflected from the screen to your eyes.

Note

When adjusting the screen tilt, proceed slowly and carefully, being sure not to hit the monitor against the desk or the base of the display stand.

- 1 Grasp the lower middle part of the LCD panel while holding the display stand, then, tilt the LCD panel adequately backward.

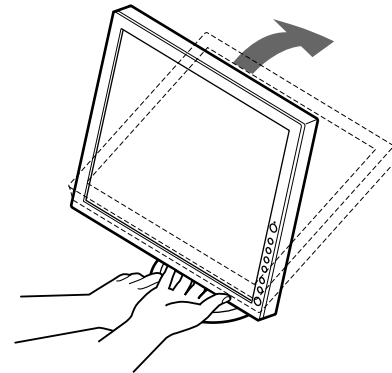

- 2 Grasp the lower sides of the LCD panel, then adjust screen tilt.

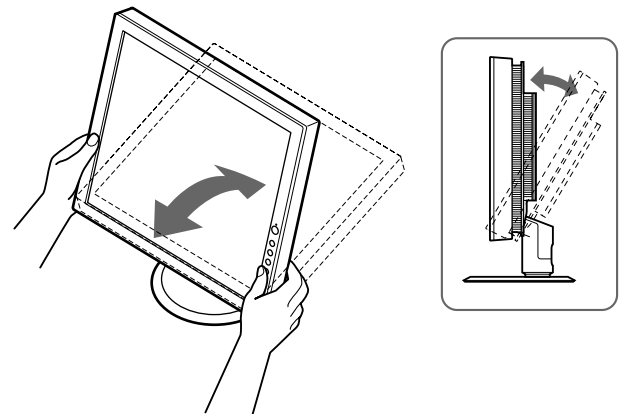

Selecting the input signal (INPUT button)

Press the INPUT button.

The input signal change each time you press this button as follows.



On-screen message) (Appears about 5 seconds on the upper left corner.)	Input indicator lights up	Input signal configuration
INPUT1: DVI-D	INPUT1	DVI-D input connector (digital RGB) for INPUT1
INPUT1: HD15	INPUT1	HD15 input connector (analog RGB) for INPUT1
INPUT2: HD15	INPUT2	HD15 input connector (analog RGB) for INPUT2

Customizing Your Monitor

Before making adjustments

Connect the monitor and the computer, and turn them on. Wait for at least 30 minutes before making adjustments for the best results.

You can make numerous adjustments to your monitor using the on-screen menu.

Navigating the menu

1 Display the main menu.

Press the MENU button to display the main menu on your screen.

MENU



2 Select the menu you want to adjust.

Press the \uparrow/\downarrow buttons to display the desired menu. Press the OK button to select the menu item.

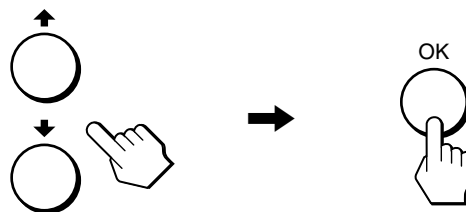

3 Adjust the menu.

Press the \uparrow/\downarrow buttons to make the adjustment, then press the OK button.

When you press the OK button, the setting is stored, then the display returns to the previous menu.

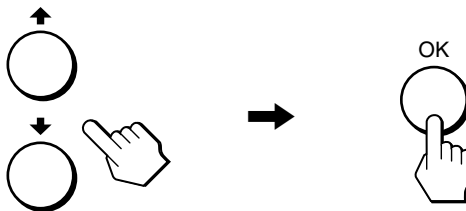

4 Close the menu.

Press the MENU button once to return to normal viewing. If no buttons are pressed, the menu closes automatically after about 45 seconds.

MENU



US

■ Resetting the adjustments to the default settings

You can reset the adjustments using the RESET menu. For more information about resetting the adjustments, see “←→ (RESET)” on page 16.

|☐ BACKLIGHT

If the screen is too bright, adjust the backlight and make the screen easier to see.

Note

The backlight cannot be adjusted when the ECO mode is set to “ON” (page 17).

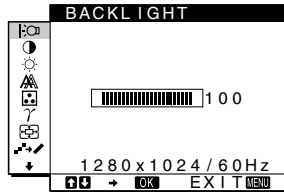

- 1 Press the MENU button.**
The main menu appears on the screen.
- 2 Press the ↑/↓ buttons to select |☐ (BACKLIGHT) and press the OK button.**
The BACKLIGHT menu appears on the screen.
- 3 Press the ↑/↓ buttons to adjust the desired light level.**

● CONTRAST

Adjust the picture contrast.

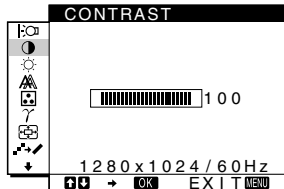

- 1 Press the MENU button.**
The main menu appears on the screen.
- 2 Press the ↑/↓ buttons to select ● (CONTRAST) and press the OK button.**
The CONTRAST menu appears on the screen.
- 3 Press the ↑/↓ buttons to adjust the contrast.**

☀ BRIGHTNESS

Adjust the picture brightness (black level).

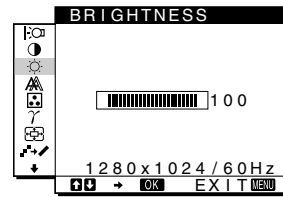

- 1 Press the MENU button.**
The main menu appears on the screen.
- 2 Press the ↑/↓ buttons to select ☀ (BRIGHTNESS) and press the OK button.**
The BRIGHTNESS menu appears on the screen.
- 3 Press the ↑/↓ buttons to adjust the brightness.**

▲ SCREEN (analog RGB signal only)

Note

When receiving digital RGB signals from the DVI-D input connector for INPUT1, adjustment is unnecessary.

■ Automatic picture quality adjustment function

When the monitor receives an input signal, it automatically adjusts the picture's position and sharpness (phase/pitch), and ensures that a clear picture appears on the screen (page 17).

Note

While the automatic picture quality adjustment function is activated, only the ⏻ (power) switch will operate.

If the automatic picture quality adjustment function of this monitor seems to not completely adjust the picture
By pressing the AUTO button, you can make further automatic adjustment of the picture quality for the current input signal (page 5).

If you still need to make further adjustments to the picture quality
You can manually adjust the picture's sharpness (phase/pitch) and position (horizontal/vertical position).

If you need to eliminate a shift of the picture occurring when the input signal has been changed
The shift is caused by the automatic picture quality adjustment function. You can deactivate this function (page 14).

These adjustments are stored in memory and automatically recalled when the display receives the same input signal.

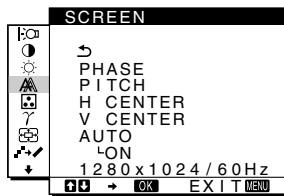

■ Adjust the picture's sharpness manually (PHASE/PITCH)

You can adjust the picture's sharpness as follows. This adjustment is effective when the computer is connected to the monitor's HD15 input connector (analog RGB).

1 Set the resolution to 1280 × 1024 on the computer.

2 Load the Utility Disk.

3 Start the Utility Disk and display the test pattern.
For Windows

Click [Utility] → [Windows]/[Win Utility.exe].

For Macintosh

Click [Utility] → [Mac]/[Mac Utility].

4 Press the MENU button.

The main menu appears on the screen.

5 Press the ↑/↓ buttons to select  (SCREEN) and press the OK button.

The SCREEN menu appears on the screen.

6 Press the ↑/↓ buttons to select PHASE and press the OK button.

The PHASE menu appears on the screen.

7 Press the ↑/↓ buttons until the horizontal stripes are at a minimum.

Adjust so that the horizontal stripes are at a minimum.

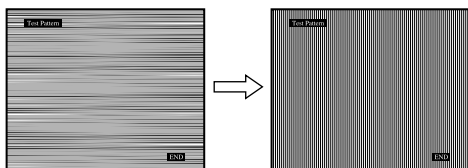

8 Press the OK button.

The main menu appears on the screen.

If vertical stripes are observed over the entire screen, adjust pitch by the following steps.

9 Press the ↑/↓ buttons to select  (SCREEN) and press the OK button.

The SCREEN menu appears on the screen.

10 Press the ↑/↓ buttons to select PITCH and press the OK button.

The PITCH menu appears on the screen.

11 Press the ↑/↓ buttons until the vertical stripes disappear.

Adjust so that the vertical stripes disappear.

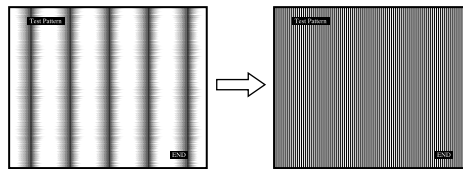

12 Click [END] on the screen to turn off the test pattern.

13 Press the ↑/↓ buttons to select  and press the OK button.

Return to the menu screen.

■ Adjust the picture's position manually (H CENTER/V CENTER)

If the picture is not in the center of the screen, adjust the picture's centering as follows.

1 Set the resolution to 1280 × 1024 on the computer.

2 Load the Utility Disk.

3 Start the Utility Disk and display the test pattern.

For Windows

Click [Utility] → [Windows]/[Win Utility.exe].

For Macintosh

Click [Utility] → [Mac]/[Mac Utility].

4 Press the MENU button.

The main menu appears on the screen.

5 Press the ↑/↓ buttons to select  (SCREEN) and press the OK button.

The SCREEN menu appears on the screen.

6 Press the ↑/↓ buttons to select H CENTER or V CENTER and press the OK button.

The H CENTER or V CENTER menu appears on the screen.

7 Press the ↑/↓ buttons to center the test pattern in the screen.

8 Click [END] on the screen to turn off the test pattern.

9 Press the ↑/↓ buttons to select  and press the OK button.

Return to the menu screen.

■ Eliminate a shift of the picture caused by the automatic picture quality adjustment (AUTO)

- 1 Press the MENU button.**
The main menu appears on the screen.
- 2 Press the ↑/↓ buttons to select  (SCREEN) and press the OK button.**
The SCREEN menu appears on the screen.
- 3 Press the ↑/↓ buttons to select AUTO and press the OK button. Then press the ↑/↓ buttons to select OFF and press the OK button.**

To resume the automatic picture quality adjustment function

Select ON in step 3 above.

COLOR

You can select the picture's color level of the white color field from the default color temperature settings. Also, if necessary, you can fine tune the color temperature.

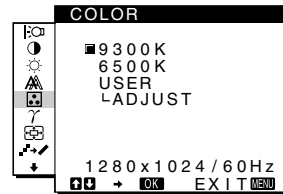

- 1 Press the MENU button.**
The main menu appears on the screen.
- 2 Press the ↑/↓ buttons to select  (COLOR) and press the OK button.**
The COLOR menu appears on the screen.
- 3 Press the ↑/↓ buttons to select the desired color temperature and press the OK button.**
Whites will change from a bluish hue to reddish hue as the temperature is lowered from 9300K (default setting) to 6500K.

Fine tuning the color temperature (USER ADJUSTMENT)

INPUT1 and INPUT2 can be set independently.

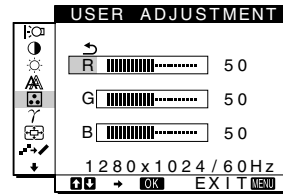

- 1 Press the ↑/↓ buttons to select ADJUST and press the OK button.**
The USER ADJUSTMENT menu appears on the screen.
- 2 Press the ↑/↓ buttons to select R (Red) or B (Blue) and press the OK button. Then press the ↑/↓ buttons to adjust the color temperature and press the OK button.**
Since this adjustment changes the color temperature by increasing or decreasing the R and B components with respect to G (green), the G component is fixed.
- 3 Press the ↑/↓ buttons to select , then press the OK button.**
The new color setting is stored in memory for USER ADJUSTMENT and automatically recalled whenever USER is selected.
The COLOR menu appears on the screen.

γ GAMMA

You can associate the picture's color shade on the screen with the picture's original color shade.

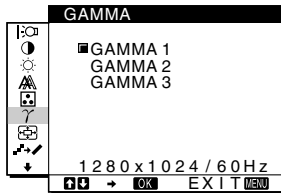

- 1 Press the MENU button.**
The main menu appears on the screen.
- 2 Press the ↑/↓ buttons to select γ (GAMMA) and press the OK button.**
The GAMMA menu appears on the screen.
- 3 Press the ↑/↓ buttons to select the desired mode.**

SMOOTHING

If the picture displayed at the FULL2 or FULL1 mode of ZOOM is not smooth, use the picture smoothing function.

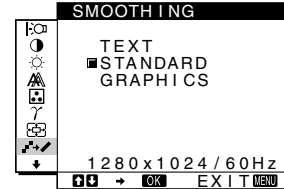

- 1 Press the MENU button.**
The main menu appears on the screen.
- 2 Press the ↑/↓ buttons to select SMOOTHING and press the OK button.**
The SMOOTHING menu appears on the screen.
- 3 Press the ↑/↓ buttons to select the desired mode.**
The smoothing effect becomes stronger in the order of TEXT→STANDARD→GRAPHICS.
 - TEXT: To make the characters appear clear. (This mode is suited for text-based applications.)
 - STANDARD (The default setting): Standard smoothing effect.
 - GRAPHICS: To make the pictures appear clean. (This mode is suited for CD-ROM software such as photo images or illustrations.)

ZOOM

The monitor is set to display the picture on the screen in full, irrespective of the picture's mode or resolution in the default setting (FULL2).

You can also view the picture in its actual aspect ratio or resolution.

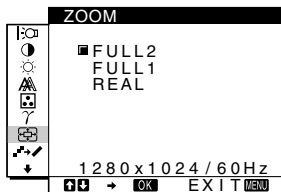

- 1 Press the MENU button.**
The main menu appears on the screen.
- 2 Press the ↑/↓ buttons to select ZOOM and press the OK button.**
The ZOOM menu appears on the screen.
- 3 Press the ↑/↓ buttons to select the desired mode.**
 - FULL2 (The default setting): The input signal is displayed on the screen in full, irrespective of the picture's mode or resolution.
 - FULL1: The input signal is displayed on the screen at its actual aspect ratio. Therefore, black bands may appear at the top and bottom of the picture depending on the signal.
 - REAL: The input signal is displayed on the screen at its actual resolution. Sub-1280 × 1024 signals are displayed at the center of the screen surrounded by a black frame.

Note





When you use 1280 × 1024 resolution signals, the above mentioned settings are not available. The picture is displayed on the screen in full.

Notes

- When you set the ZOOM menu to REAL, the SMOOTHING menu is not available.
- 1280 × 1024 resolution signals are shown only in REAL mode and SMOOTHING is not possible.

Additional settings

The following menus appear on the screen when you keep pressing the ↓ button.

- MENU POSITION 
- POWER SAVE 
- LANGUAGE 
- RESET 
- MENU LOCK 

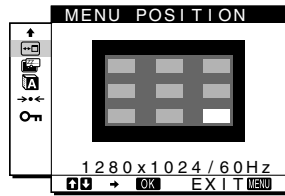

- 1 Press the MENU button.**
The main menu appears on the screen.
- 2 Keep pressing the ↓ button until the desired menu's item you want to adjust appears on the screen.**
- 3 Press the ↑/↓ buttons to select the desired menu and press the OK button.**
Adjust the selected menu according to the following instructions.

■ MENU POSITION

You can change the menu position if it is blocking an image on the screen.

- 1 Press the ↑/↓ buttons to select  (MENU POSITION) and press the OK button.**
The MENU POSITION menu appears on the screen.
- 2 Press the ↑/↓ buttons to select the desired position and press the OK button.**
You can choose one of 9 positions where the menu will appear.

■ POWER SAVE

Set the power saving mode (page 17).



- 1 Press the ↑/↓ buttons to select  (POWER SAVE) and press the OK button.**
The POWER SAVE menu appears on the screen.
- 2 Press the ↑/↓ buttons to select either ON or OFF.**
 - ON: Enters the power saving mode automatically when no input signal is being input via currently selected computer.
 - OFF: Not enter the power saving mode.

■ LANGUAGE

- 1 Press the ↑/↓ buttons to select  (LANGUAGE) and press the OK button.**
The LANGUAGE menu appears on the screen.
- 2 Press the ↑/↓ buttons to select a language.**
 - ENGLISH
 - FRANÇAIS: French
 - DEUTSCH: German
 - ESPAÑOL: Spanish
 - ITALIANO: Italian
 - NEDERLANDS: Dutch
 - SVENSKA: Swedish
 - РУССКИЙ: Russian
 - 日本語: Japanese





■ RESET

Reset the adjustments to the default settings.

- 1 Press the ↑/↓ buttons to select  (RESET) and press the OK button.**
The RESET menu appears on the screen.
- 2 Press the ↑/↓ buttons to select the desired mode.**
 - OK: To reset all of the adjustment data to the default setting. Note that the  (LANGUAGE) setting is not reset by this method.
 - CANCEL: To cancel resetting and return to the menu screen.

■ MENU LOCK

Lock the control of buttons to prevent accidental adjustments or resetting.

- 1 Press the ↑/↓ buttons to select  (MENU LOCK) and press the OK button.**
The MENU LOCK menu appears on the screen.
- 2 Press the ↑/↓ buttons to select ON or OFF.**
 - ON: Only the  (power) switch and INPUT button will operate. If you attempt any other operation, the  (MENU LOCK) appears on the screen.
 - OFF: Set  (MENU LOCK) to OFF. If you set the  (MENU LOCK) to ON, only this menu item can be selected.

Technical Features

Power saving function

This monitor meets the power-saving guidelines set by VESA, ENERGY STAR, and NUTEK. If the monitor is connected to a computer or video graphics board that is DPMS (Display Power Management Signaling) compliant, the monitor will automatically reduce power consumption as shown below.

Power mode	Power consumption	⏻ (power) indicator
normal operation	58 W (max.)	green
active off* (deep sleep)**	3 W (max.)	orange
⏻ (power) off	1 W	red
main power off	0 W	off

- * When your computer enters the “active off” mode, the input signal is cut and NO INPUT SIGNAL appears on the screen. After 20 seconds, the monitor enters the power saving mode.
- ** “Deep sleep” is a power saving mode defined by the Environmental Protection Agency.

Note

If the  (POWER SAVE) is set to OFF (page 16), the monitor does not enter the power saving mode.

Reducing the power consumption (ECO mode)

If you press the ECO button on the front of the monitor, the backlight level reduces and the power consumption is reduced.

Press the ECO button.

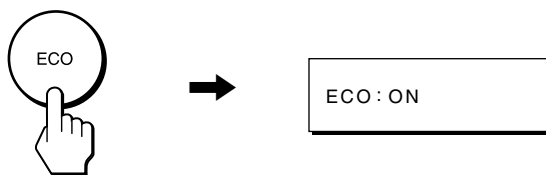

The ECO: ON menu appears on the screen and the backlight level is reduced. The menu automatically disappears after about 5 seconds.

To cancel the ECO mode

Press the ECO button again.

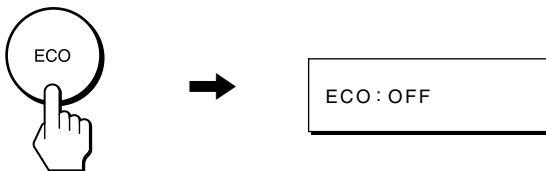

The ECO: OFF menu appears on the screen and normal backlight level is set. The menu automatically disappears after about 5 seconds.

Automatic picture quality adjustment function (analog RGB signal only)

When the monitor receives an input signal, it automatically adjusts the picture's position and sharpness (phase/pitch), and ensures that a clear picture appears on the screen.

The factory preset mode

When the monitor receives an input signal, it automatically matches the signal to one of the factory preset modes stored in the monitor's memory to provide a high quality picture at the center of the screen. If the input signal matches the factory preset mode, the picture is appears on the screen automatically with the appropriate default adjustment.

If input signals do not match one of the factory preset modes

When the monitor receives an input signal, the automatic picture quality adjustment function of this monitor is activated and ensures that a clear picture always appears on the screen (within the following monitor frequency ranges):

Horizontal frequency: 28 – 92 kHz

Vertical frequency: 56 – 85Hz

Consequently, the first time the monitor receives input signals that do not match one of the factory preset modes, the monitor may take a longer time than normal for displaying the picture on the screen. This adjustment data is automatically stored in memory so that next time, the monitor will function in the same way as when the monitor receives the signals that match one of the factory preset modes.

If you adjust the phase, pitch, and pictures position manually

For some input signals, the automatic picture quality adjustment function of this monitor may not completely adjust the picture position, phase, and pitch. In this case, you can manually set these adjustments (page 12). If you manually set these adjustments, they are stored in memory as user modes and automatically recalled whenever the monitor receives the same input signals.

US

Troubleshooting

Before contacting technical support, refer to this section.

On-screen messages

If there is something wrong with the input signal, one of the following messages appears on the screen. To solve the problem, see “Trouble symptoms and remedies” on page 19.

If OUT OF SCAN RANGE appears on the screen

This indicates that the input signal is not supported by the monitor’s specifications. Check the following items. For more information about on-screen messages, see “Trouble symptoms and remedies” on page 19.

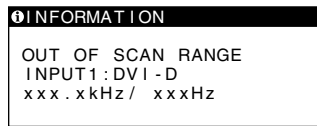

If “xxx.x kHz/xxx Hz” is displayed

This indicates that either the horizontal or vertical frequency is not supported by the monitor’s specifications. The figures indicate the horizontal and vertical frequencies of the current input signal.

If “RESOLUTION > 1280 × 1024” is displayed

This indicates that the resolution is not supported by the monitor’s specifications (1280 × 1024 or less).

If NO INPUT SIGNAL appears on the screen

This indicates that no signal is being input via the currently selected connector.

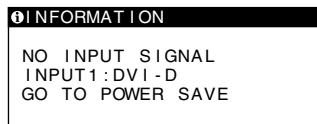

GO TO POWER SAVE

If the  (POWER SAVE) is set to “ON,” the monitor will enter the power saving mode after about 5 seconds from the time the message is displayed.

If CABLE DISCONNECTED appears on the screen

This indicates that the video signal cable has been disconnected from the currently selected connector.

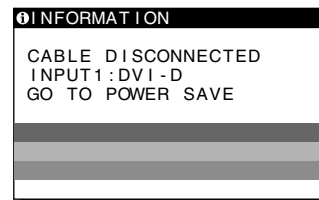







GO TO POWER SAVE

If the  (POWER SAVE) is set to “ON,” the monitor will enter the power saving mode after about 5 seconds from the time the message is displayed.

Trouble symptoms and remedies

If a problem occurs as a result of a connected computer or other equipment, refer to the connected computer/equipment's instruction manual. Use the self-diagnosis function (page 21) if the following recommendations do not resolve the problem.

Symptom	Check these items
No picture	
If the  (power) indicator is not lit, or if the  (power) indicator will not light up when the  (power) switch is pressed,	<ul style="list-style-type: none"> • Check that the power cord is properly connected. • Check that the monitor's MAIN POWER switch is "on" (page 9).
The  (power) indicator turns on red.	<ul style="list-style-type: none"> • Check that the  (power) switch is on.
If the  (power) indicator is green,	<ul style="list-style-type: none"> • Use the self-diagnosis function (page 21).
If CABLE DISCONNECTED appears on the screen,	<ul style="list-style-type: none"> • Check that the video signal cable is properly connected and all plugs are firmly seated in their sockets (page 7). • Check that the video input connector's pins are not bent or pushed in. • Check that the input select setting is correct (page 11). • A non-supplied video signal cable is connected. If you connect a non-supplied video signal cable, CABLE DISCONNECTED may appear on the screen before entering the power saving mode. This is not a malfunction.
If NO INPUT SIGNAL appears on the screen, or the  (power) indicator is orange,	<ul style="list-style-type: none"> • Check that the video signal cable is properly connected and all plugs are firmly seated in their sockets (page 7). • Check that the video input connector's pins are not bent or pushed in. • Check that the input select setting is correct (page 11). <p>■ Problem caused by a connected computer or other equipment, and not caused by the monitor</p> <ul style="list-style-type: none"> • The computer is in the power saving mode. Try pressing any key on the keyboard or moving the mouse. • Check that your graphics board is attached to the computer properly. • Check that the computer's power is "on."
If OUT OF SCAN RANGE appears on the screen (page 18),	<p>■ Problem caused by a connected computer or other equipment, and not caused by the monitor</p> <ul style="list-style-type: none"> • Check that the video frequency range is within that specified for the monitor. If you replaced an old monitor with this monitor, reconnect the old monitor and adjust the computer's graphics board in the following ranges: Horizontal frequency: 28 – 92 kHz Vertical frequency: 56 – 85 Hz Resolution: 1280 × 1024 or less
If using Windows,	<ul style="list-style-type: none"> • If you replaced an old monitor with this monitor, reconnect the old monitor and do the following. Select "SONY" from the "Manufacturers" list and select "SDM-P82" from the "Models" list in the Windows device selection screen. If "SDM-P82" does not appear in the "Models" list, try "Plug & Play" or install the information file for this monitor using the Windows Monitor Information Disk.
If using a Macintosh system,	<ul style="list-style-type: none"> • When connecting a Macintosh computer, use an adapter (not supplied) if necessary. Connect the adapter to the computer before connecting the video signal cable.

US

(continued)

Symptom	Check these items
Picture flickers, bounces, oscillates, or is scrambled.	<ul style="list-style-type: none"> Adjust the pitch and phase (analog RGB signal only) (page 12). Isolate and eliminate any potential sources of electric or magnetic fields such as other monitors, laser printers, electric fans, fluorescent lighting, or televisions. Move the monitor away from power lines or place a magnetic shield near the monitor. Try plugging the monitor into a different AC outlet, preferably on a different circuit. Change the orientation of the monitor. <p>■ Problem caused by a connected computer or other equipment, and not caused by the monitor</p> <ul style="list-style-type: none"> Check your graphics board manual for the proper monitor setting. Confirm that the graphics mode (VESA, Macintosh 19" Color, etc.) and the frequency of the input signal are supported by this monitor. Even if the frequency is within the proper range, some graphics boards may have a sync pulse that is too narrow for the monitor to sync correctly. This monitor does not process the interlace signals. Set for progressive signals. Adjust the computer's refresh rate (vertical frequency) to obtain the best possible picture (60 Hz is recommended).
Picture is fuzzy.	<ul style="list-style-type: none"> Adjust the brightness and contrast (page 12). Adjust the pitch and phase (analog RGB signal only) (page 12). <p>■ Problem caused by a connected computer or other equipment, and not caused by the monitor</p> <ul style="list-style-type: none"> Set the resolution to 1280 × 1024 on your computer.
Picture is ghosting.	<ul style="list-style-type: none"> Eliminate the use of video cable extensions and/or video switch boxes. Check that all plugs are firmly seated in their sockets.
Picture is not centered or sized properly (analog RGB signal only).	<ul style="list-style-type: none"> Adjust the pitch and phase (page 12). Adjust the picture position (page 13). Note that some video modes do not fill the screen to the edges.
Picture is too small.	<ul style="list-style-type: none"> Set the zoom setting to FULL2 (page 15). <p>■ Problem caused by a connected computer or other equipment, and not caused by the monitor</p> <ul style="list-style-type: none"> Set the resolution to 1280 × 1024 on your computer.
Picture is dark.	<ul style="list-style-type: none"> Adjust the brightness (page 12). Adjust the backlight (page 12). It takes a few minutes for the display to become bright after turning on the monitor. Adjust γ (GAMMA)(page 15). If you press the ECO button, the screen turns darker.
Wavy or elliptical pattern (moire) is visible.	<ul style="list-style-type: none"> Adjust the pitch and phase (analog RGB signal only) (page 12).
Color is not uniform.	<ul style="list-style-type: none"> Adjust the pitch and phase (analog RGB signal only) (page 12).
White does not look white.	<ul style="list-style-type: none"> Adjust the color temperature (page 14).
Monitor buttons do not operate (ON appears on the screen).	<ul style="list-style-type: none"> If the menu lock is set to ON, set it to OFF (page 16).
The monitor turns off after a while.	<ul style="list-style-type: none"> Set the power saving function to OFF (page 16). <p>■ Problem caused by a connected computer or other equipment, and not caused by the monitor</p> <ul style="list-style-type: none"> Set the computer's power saving setting to off.

Displaying this monitor's name, serial number, and date of manufacture.

While the monitor is receiving a video signal, press and hold the MENU button for more than 5 seconds.

The monitor's information box appears. Press the MENU button again to make the box disappear.

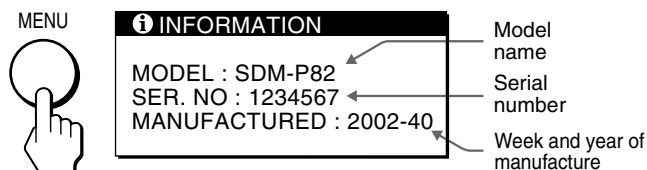

Example



If any problem persists, call your authorized Sony dealer and give the following information:



- Model name: SDM-P82
- Serial number
- Name and specifications of your computer and graphics board.
- Type of input signals (analog RGB/digital RGB)

Self-diagnosis function

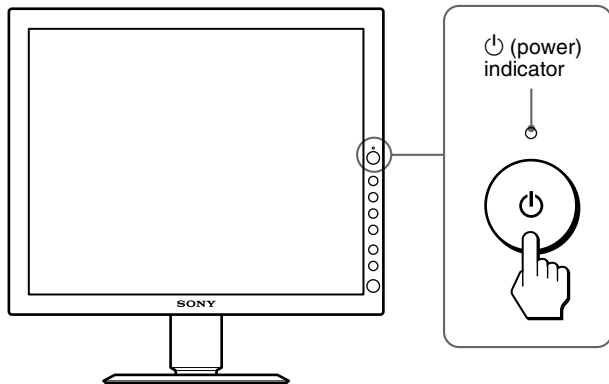
This monitor is equipped with a self-diagnosis function. If there is a problem with your monitor or computer(s), the screen will go blank and the  (power) indicator will either light up green or flash orange. If the  (power) indicator is lit in orange, the computer is in power saving mode. Try pressing any key on the keyboard or moving the mouse.



If the picture disappears from the screen and the  (power) indicator is green

- 1 Turn off the  (power) switch and disconnect the video signal cables from the monitor.
- 2 Turn the monitor on by pressing the  (power) switch.

If all four color bars appear (white, red, green, blue), the monitor is working properly. Reconnect the video input cables and check the condition of your computer(s).

If the color bars do not appear, there is a potential monitor failure. Inform your authorized Sony dealer of the monitor's condition.

If the  (power) indicator lights up in orange

Try pressing any key on the keyboard or moving the mouse.

The computer's power saving mode is awaked and the  (power) indicator lights up in green, and the picture appears on the screen.

Specifications

LCD panel	Panel type: a-Si TFT Active Matrix Picture size: 18.1 inch
Input signal format	RGB operating frequency* Horizontal: 28 – 92 kHz Vertical: 56 – 85 Hz
Resolution	Horizontal: Max.1280 dots Vertical: Max.1024 lines
Input signal levels	Analog RGB video signal 0.7 Vp-p, 75 Ω, positive SYNC signal TTL level, 2.2 kΩ, positive or negative (Separate horizontal and vertical, or composite sync) 0.3 Vp-p, 75Ω, negative (Sync on green) Digital RGB (DVI) signal: TMDS (Single link)
Power requirements	100 – 240 V, 50 – 60 Hz, Max. 1.2 A
Power consumption	Max. 58 W
Operating temperature	5 – 35 °C
Dimensions (width/height/depth)	Display (upright): Approx. 404 × 406 × 201 mm (16 × 16 × 8 inches) (with stand) Approx. 404 × 332.6 × 86.2 mm (16 × 13 1/8 × 3 1/2 inches) (without stand)
Mass	Approx. 7.6 kg (16 lb 12 oz) (with stand) Approx. 6.3 kg (13 lb 14 oz) (without stand)
Plug & Play	DDC2B
Accessories	See page 7.

- * Recommended horizontal and vertical timing condition
- Horizontal sync width duty should be more than 4.8% of total horizontal time or 0.8 μs, whichever is larger.
 - Horizontal blanking width should be more than 2.5 μsec.
 - Vertical blanking width should be more than 450 μsec.

Design and specifications are subject to change without notice.

US

TCO'95 Eco-document (for the black model)

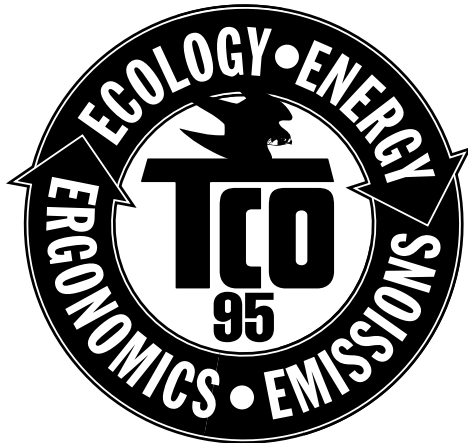

■ Congratulations!

You have just purchased a TCO'95 approved and labelled product! Your choice has provided you with a product developed for professional use. Your purchase has also contributed to reducing the burden on the environment and also, to the further development of environmentally adapted electronics products.

■ Why do we have environmentally labelled computers?

In many countries, environmental labelling has become an established method for encouraging the adaptation of goods and services to the environment. The main problem, as far as computers and other electronics equipment are concerned, is that environmentally harmful substances are used both in the products and during the manufacturing. Since it has not been possible for the majority of electronics equipment to be recycled in a satisfactory way, most of these potentially damaging substances sooner or later enter Nature.

There are also other characteristics of a computer, such as energy consumption levels, that are important from the viewpoints of both the work (internal) and natural (external) environments. Since all methods of conventional electricity generation have a negative effect on the environment (acidic and climate-influencing emissions, radioactive waste, etc.), it is vital to conserve energy. Electronics equipment in offices consume an enormous amount of energy since they are often left running continuously.

■ What does labelling involve?

This product meets the requirements for the TCO'95 scheme which provides for international and environmental labelling of personal computers. The labelling scheme was developed as a joint effort by the TCO (The Swedish Confederation of Professional Employees), Naturskyddsforeningen (The Swedish Society for Nature Conservation) and NUTEK (The National Board for Industrial and Technical Development in Sweden).

The requirements cover a wide range of issues: environment, ergonomics, usability, emission of electrical and magnetic fields, energy consumption and electrical and fire safety.

The environmental demands concern restrictions on the presence and use of heavy metals, brominated and chlorinated flame retardants, CFCs (freons) and chlorinated solvents, among other things. The product must be prepared for recycling and the manufacturer is obliged to have an environmental plan which must be adhered to in each country where the company implements its operational policy.

The energy requirements include a demand that the computer and/or display, after a certain period of inactivity, shall reduce its power consumption to a lower level in one or more stages. The length of time to reactivate the computer shall be reasonable for the user.

Labelled products must meet strict environmental demands, for example, in respect of the reduction of electric and magnetic fields, physical and visual ergonomics and good usability.

On this page, you will find a brief summary of the environmental requirements met by this product. The complete environmental criteria document may be ordered from:

TCO Development Unit

S-114 94 Stockholm

Sweden

Fax: +46 8 782 92 07

Email (Internet): development@tco.se

Current information regarding TCO'95 approved and labelled products may also be obtained via the Internet, using the address: <http://www.tco-info.com/>

TCO'95 is a co-operative project between TCO (The Swedish Confederation of Professional Employees), Naturskyddsforeningen (The Swedish Society for Nature Conservation) and NUTEK (The National Board for Industrial and Technical Development in Sweden).

■ Environmental Requirements

Brominated flame retardants

Brominated flame retardants are present in printed circuit boards, cables, wires, casings and housings. In turn, they delay the spread of fire. Up to thirty percent of the plastic in a computer casing can consist of flame retardant substances. These are related to another group of environmental toxins, PCBs, which are suspected to give rise to similar harm, including reproductive damage in fish-eating birds and mammals, due to the bio-accumulative* processes. Flame retardants have been found in human blood and researchers fear that disturbances in foetus development may occur.

TCO'95 demand requires that plastic components weighing more than 25 grams must not contain organically bound chlorine and bromine.

Lead**

Lead can be found in picture tubes, display screens, solders and capacitors. Lead damages the nervous system and in higher doses, causes lead poisoning.

TCO'95 requirement permits the inclusion of lead since no replacement has yet been developed.

Cadmium**

Cadmium is present in rechargeable batteries and in the colour-generating layers of certain computer displays. Cadmium damages the nervous system and is toxic in high doses.

TCO'95 requirement states that batteries may not contain more than 25 ppm (parts per million) of cadmium. The colour-generating layers of display screens must not contain any cadmium.

Mercury**

Mercury is sometimes found in batteries, relays and switches. Mercury damages the nervous system and is toxic in high doses.

TCO'95 requirement states that batteries may not contain more than 25 ppm (parts per million) of mercury. It also demands that no mercury is present in any of the electrical or electronics components concerned with the display unit.

CFCs (freons)

CFCs (freons) are sometimes used for washing printed circuit boards and in the manufacturing of expanded foam for packaging. CFCs break down ozone and thereby damage the ozone layer in the stratosphere, causing increased reception on Earth of ultraviolet light with consequent increased risks of skin cancer (malignant melanoma).

The relevant TCO'95 requirement: Neither CFCs nor HCFCs may be used during the manufacturing of the product or its packaging.

* Bio-accumulative is defined as substances which accumulate within living organisms

** Lead, Cadmium and Mercury are heavy metals which are Bio-accumulative.

