

SONY®

TFT LCD Color Computer Display

***SDM-S53
SDM-S73
SDM-S93***

Owner's Record

The model and serial numbers are located at the rear of the unit. Record these numbers in the spaces provided below. Refer to them whenever you call upon your dealer regarding this product.

Model No. _____ Serial No. _____

WARNING

To prevent fire or shock hazard, do not expose the unit to rain or moisture.

Dangerously high voltages are present inside the unit. Do not open the cabinet. Refer servicing to qualified personnel only.

FCC Notice

This equipment has been tested and found to comply with the limits for a Class B digital device, pursuant to Part 15 of the FCC Rules. These limits are designed to provide reasonable protection against harmful interference in a residential installation. This equipment generates, uses, and can radiate radio frequency energy and, if not installed and used in accordance with the instructions, may cause harmful interference to radio communications. However, there is no guarantee that interference will not occur in a particular installation. If this equipment does cause harmful interference to radio or television reception, which can be determined by turning the equipment off and on, the user is encouraged to try to correct the interference by one or more of the following measures:

- Reorient or relocate the receiving antenna.
- Increase the separation between the equipment and receiver.
- Connect the equipment into an outlet on a circuit different from that to which the receiver is connected.
- Consult the dealer or an experienced radio/TV technician for help.

You are cautioned that any changes or modifications not expressly approved in this manual could void your authority to operate this equipment.

IMPORTANTE

Para prevenir cualquier mal funcionamiento y evitar daños, por favor, lea detalladamente este manual de instrucciones antes de conectar y operar este equipo.

**If you have any questions about this product, you may call;
Sony Customer Information Services Center
1-800-222-7669 or <http://www.sony.com/>**

Declaration of Conformity

Trade Name: SONY
Model: SDM-S53/S73/S93
Responsible Party: Sony Electronics Inc.
Address: 16450 W. Bernardo Dr,
San Diego, CA 92127 U.S.A.
Telephone Number: 858-942-2230

This device complies with part 15 of the FCC rules. Operation is subject to the following two conditions: (1) This device may not cause harmful interference, and (2) this device must accept any interference received, including interference that may cause undesired operation.

NOTICE

This notice is applicable for USA/Canada only. If shipped to USA/Canada, install only a UL LISTED/CSA LABELLED power supply cord meeting the following specifications:

SPECIFICATIONS

Plug Type	Nema-Plug 5-15p
Cord	Type SVT or SJT, minimum 3 × 18 AWG
Length	Maximum 15 feet
Rating	Minimum 7 A, 125 V

NOTICE

Cette notice s'applique aux Etats-Unis et au Canada uniquement.

Si cet appareil est export* aux Etats-Unis ou au Canada, utiliser le cordon d'alimentation portant la mention UL LISTED/CSA LABELLED et remplissant les conditions suivantes:

SPECIFICATIONS

Type de fiche	Fiche Nema 5-15 broches
Cordon	Type SVT ou SJT, minimum 3 × 18 AWG
Longueur	Maximum 15 pieds
Tension	Minimum 7 A, 125 V

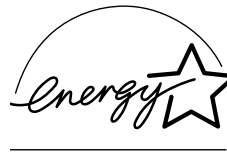

As an ENERGY STAR Partner, Sony Corporation has determined that this product meets the ENERGY STAR guidelines for energy efficiency.

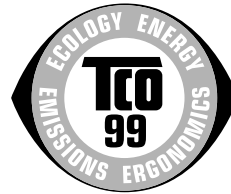











This monitor complies with the TCO'99 guidelines.



BZ03

Table of Contents

Precautions	4
Identifying parts and controls	5
Setup	6
Setup 1: Connect the video signal cables	6
Setup 2: Connect the power cord	7
Setup 3: Secure the cords and close the back cover	8
Setup 4: Turn on the monitor and computer	8
Setup 5: Adjusting the tilt	9
Customizing Your Monitor	10
Navigating the menu	10
 Adjusting the backlight (BACKLIGHT)	11
 Adjusting the contrast (CONTRAST)	11
 Adjusting the black level of an image (BRIGHTNESS)	11
 Adjusting the picture's sharpness and centering (SCREEN)	12
 Adjusting the color temperature (COLOR)	13
 Changing the gamma setting (GAMMA)	14
 Changing the menu's position (MENU POSITION)	14
 Selecting the on-screen menu language (LANGUAGE)	14
 Resetting the adjustment data to the defaults (RESET)	14
 Locking the menus and controls (MENU LOCK)	14
Technical Features	15
Power saving function	15
Reducing the power consumption (ECO mode)	15
Automatic picture quality adjustment function	15
Troubleshooting	16
On-screen messages	16
Trouble symptoms and remedies	18
Self-diagnosis function	20
Specifications	21

GB

- Macintosh is a trademark licensed to Apple Computer, Inc., registered in the U.S.A. and other countries.
- Windows® is registered trademarks of Microsoft Corporation in the United States and other countries.
- IBM PC/AT and VGA are registered trademarks of IBM Corporation of the U.S.A.
- VESA and DDC™ are trademarks of the Video Electronics Standards Association.
- ENERGY STAR is a U.S. registered mark.
- Adobe and Acrobat are trademarks of Adobe Systems Incorporated.
- All other product names mentioned herein may be the trademarks or registered trademarks of their respective companies.
- Furthermore, “™” and “®” are not mentioned in each case in this manual.

Precautions

Warning on power connections

- Use the supplied power cord. If you use a different power cord, be sure that it is compatible with your local power supply.

For the customers in the U.S.A.

If you do not use the appropriate cord, this monitor will not conform to mandatory FCC standards.

For the customers in the UK

If you use the monitor in the UK, be sure to use the appropriate UK power cord.

Example of plug types

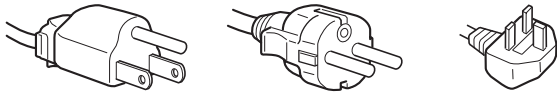

for 100 to 120 V AC for 200 to 240 V AC for 240 V AC only

The equipment should be installed near an easily accessible outlet.

Installation

Do not install or leave the monitor:

- In places subject to extreme temperatures, for example near a radiator, heating vent, or in direct sunlight. Subjecting the monitor to extreme temperatures, such as in an automobile parked in direct sunlight or near a heating vent, could cause deformations of the casing or malfunctions.
- In places subject to mechanical vibration or shock.
- Near any equipment that generates a strong magnetic field, such as a TV or various other household appliances.
- In places subject to inordinate amounts of dust, dirt, or sand, for example near an open window or an outdoor exit. If setting up temporarily in an outdoor environment, be sure to take adequate precautions against airborne dust and dirt. Otherwise irreparable malfunctions could occur.

Handling the LCD screen

- Do not leave the LCD screen facing the sun as it can damage the LCD screen. Take care when you place the monitor by a window.
- Do not push on or scratch the LCD screen. Do not place a heavy object on the LCD screen. This may cause the screen to lose uniformity or cause LCD panel malfunctions.
- If the monitor is used in a cold place, a residual image may appear on the screen. This is not a malfunction. The screen returns to normal as the temperature rises to a normal operating level.
- If a still picture is displayed for a long time, a residual image may appear for a while. The residual image will eventually disappear.
- The LCD panel becomes warm during operation. This is not a malfunction.

Note on the LCD (Liquid Crystal Display)

Please note that the LCD screen is made with high-precision technology. However, black points or bright points of light (red, blue, or green) may appear constantly on the LCD screen, and irregular colored stripes or brightness may appear on the LCD screen. This is not malfunction.

(Effective dots: more than 99.99%)

Maintenance

- Be sure to unplug the power cord from the power outlet before cleaning your monitor.
- Clean the LCD screen with a soft cloth. If you use a glass cleaning liquid, do not use any type of cleaner containing an anti-static solution or similar additive as this may scratch the LCD screen's coating.
- Clean the cabinet, panel, and controls with a soft cloth lightly moistened with a mild detergent solution. Do not use any type of abrasive pad, scouring powder, or solvent, such as alcohol or benzene.
- Do not rub, touch, or tap the surface of the screen with sharp or abrasive items such as a ballpoint pen or screwdriver. This type of contact may result in a scratched picture tube.
- Note that material deterioration or LCD screen coating degradation may occur if the monitor is exposed to volatile solvents such as insecticide, or if prolonged contact is maintained with rubber or vinyl materials.

Transportation

- Disconnect all cables from the monitor and grasp both side of the LCD display firmly taking care not to scratch the screen when transporting. If you drop the monitor, you may be injured or the monitor may be damaged.
- When you transport this monitor for repair or shipment, use the original carton and packing materials.

Disposal of the monitor

- Do not dispose of this monitor with general household waste.
- The fluorescent tube used in this monitor contains mercury. Disposal of this monitor must be carried out in accordance to the regulations of your local sanitation authority.

Identifying parts and controls

See the pages in parentheses for further details.

Front of the LCD display

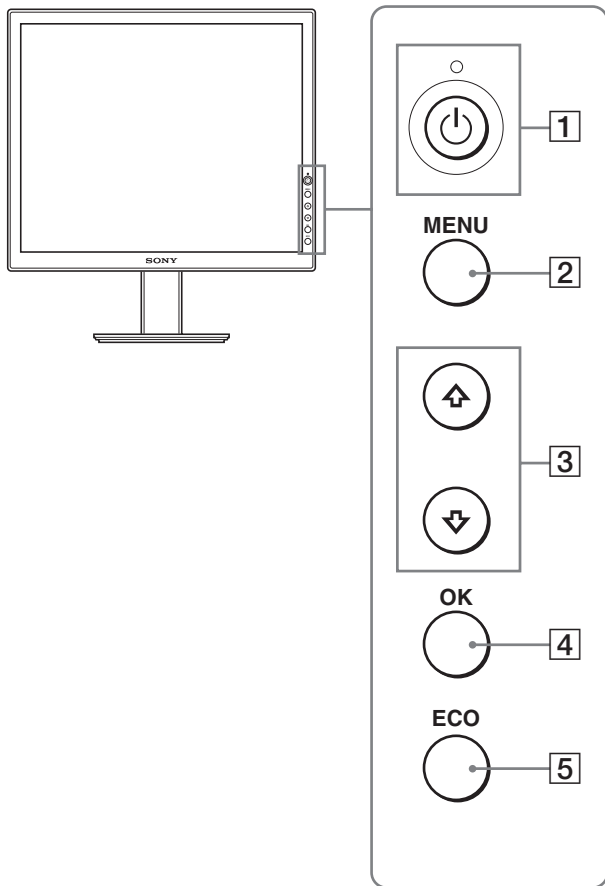

Side view of the LCD display

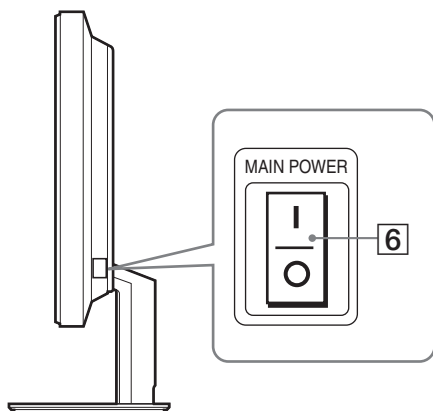

1 (Power) switch and (power) indicator (pages 8, 15, 20)

This switch turns the monitor on when the  (power) indicator lights up in red. To turn the monitor off, press this switch again.

If the  (power) indicator does not light up, press the MAIN POWER switch (**6**).



2 MENU button (pages 10, 11)

This button turns the menu screen on and off.

3 / buttons (page 11)

These buttons are used to select the menu items and make adjustments.

4 OK button (page 11)

This button activates the selected menu item and adjustments made using the / buttons (**3**).

5 ECO button (page 15)

This button is used to reduce the power consumption.

6 MAIN POWER switch (page 8)

This switch turns the monitor's main power on and off.

Rear of the LCD display

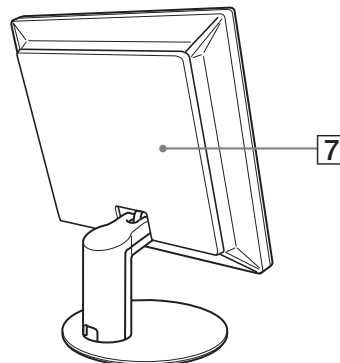

7 Back cover (page 8)

Remove this cover when you connect cables or cords.

GB

(continued)

SDM-S53/S73

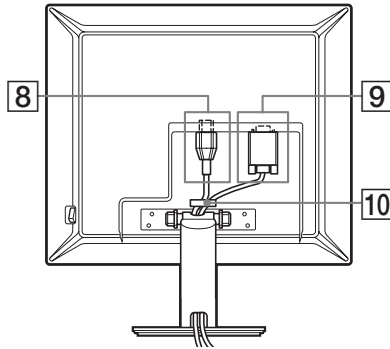

The illustration of the back of the monitor show here is the SDM-S53.

SDM-S93

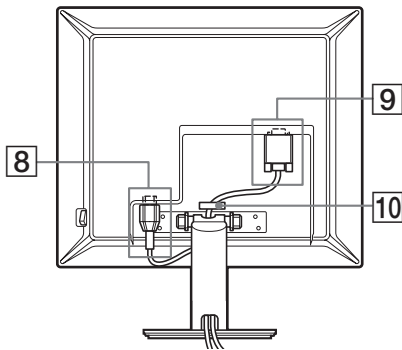

8 AC IN connector (page 7)

This connector connects the power cord (supplied).

9 HD15 (RGB) input connector

This connector inputs analog RGB video signals (0.700 Vp-p, positive) and sync signals.

10 Cable holder (page 8)

This part secures cables and cords to the monitor.

Setup

Before using your monitor, check that the following items are included in your carton:

- LCD display
- Power cord
- HD15-HD15 video signal cable
- CD-ROM (utility software for Windows/Macintosh, Operating Instructions, etc.)
- Warranty card
- Quick Setup Guide

Setup 1: Connect the video signal cables

Turn off the monitor and computer before connecting.

Notes

- Do not touch the pins of the video signal cable connector as this might bend the pins.
- Check the alignment of the HD15 connector to prevent bending the pins of the video signal cable connector.

1 Slide up the back cover.

2 Tilt the display forward.

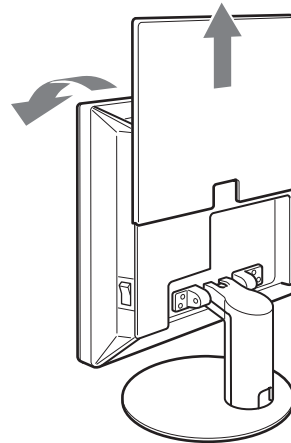

Connect a computer equipped with an HD15 output connector (analog RGB)

Using the supplied HD15-HD15 video signal cable (analog RGB), connect the computer to the monitor's HD 15 input connector (analog RGB).

Connect the computer according to the following illustrations.

■ **Connecting to an IBM PC/AT or compatible computer**

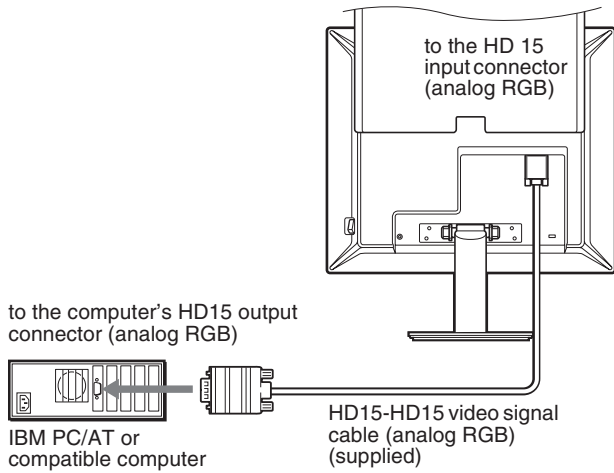

■ **Connecting to a Macintosh computer**

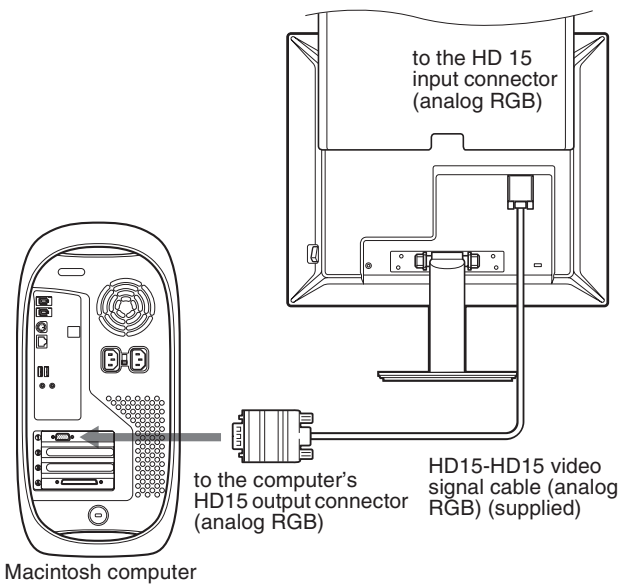

When connecting a Macintosh computer, use an adapter (not supplied), if necessary. Connect the adapter to the computer before connecting the video signal cable.

Setup 2: Connect the power cord

- 1 Connect the supplied power cord securely to the monitor's AC IN connector.
- 2 Connect the other end securely to a power outlet.

SDM-S53/S73

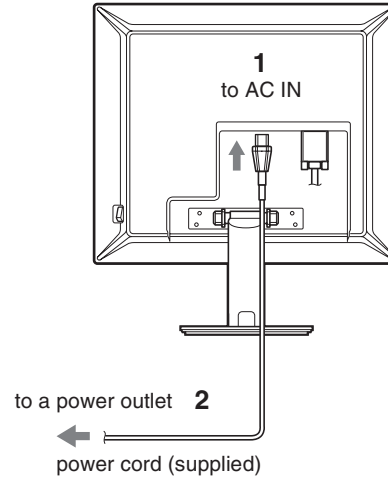

The illustration of the back of the monitor show here is that of the SDM-S53. The same applies for the SDM-S73 model.

SDM-S93

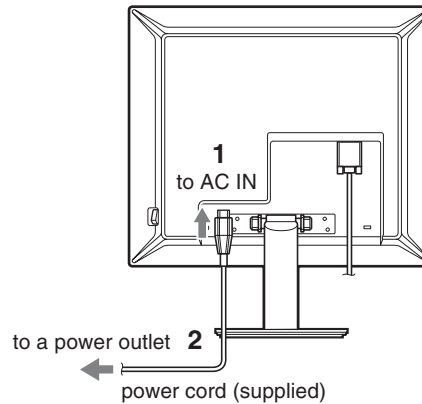

GB

Setup 3: Secure the cords and close the back cover

- 1 Slide up the back cover.
- 2 Remove the stand cover.
- 3 Secure the power cord and video signal cable using the cable holder on the cabinet (SDM-S53/S73). Secure the video signal cable using the cable holder on the cabinet (SDM-S93).
- 4 Feed the power cord and the video signal cable into the stand, and secure them using the cable holder (SDM-S53/S73). Feed the power cord through the hole on the left of the stand and secure the power cord and video signal cable using the cable holder inside (SDM-S93).
- 5 Replace the stand cover and then slide down the back cover.
Please be sure that cords come out through the opening at the bottom of the stand cover, for proper placement of the stand cover.

SDM-S53/S73

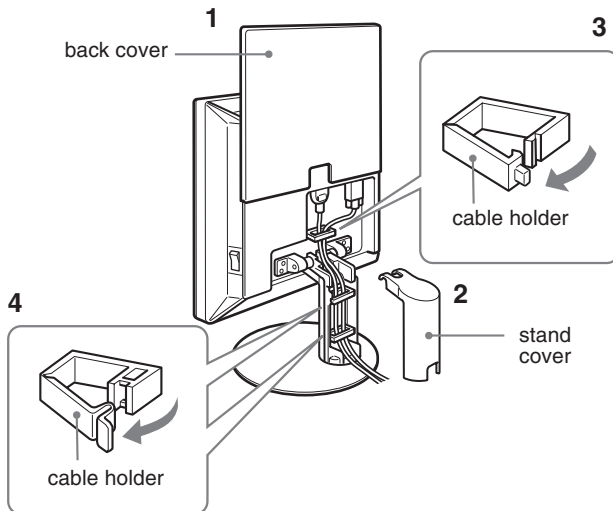

Illustrations of monitor rear are the SDM-S53.
The same applies for the SDM-S73 model.

SDM-S93

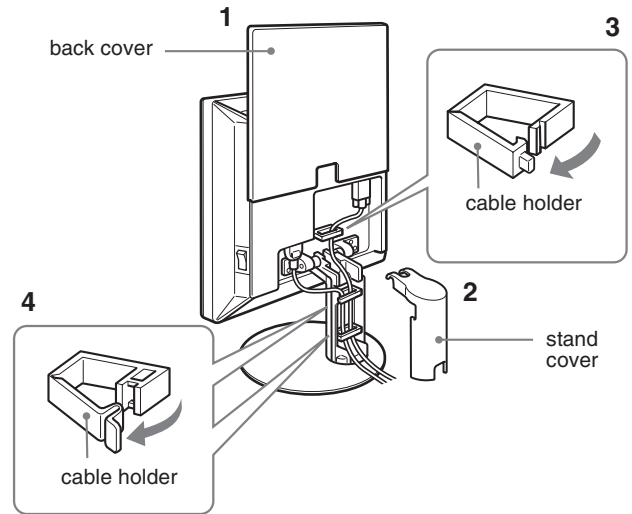

Setup 4: Turn on the monitor and computer

- 1 Press the MAIN POWER switch located on the right side of the monitor in the direction of the I, if it is not already pressed. Make sure the ⏻ (power) indicator is lit in red.

Note

The monitor is factory shipped with the MAIN POWER switch set to on (I).

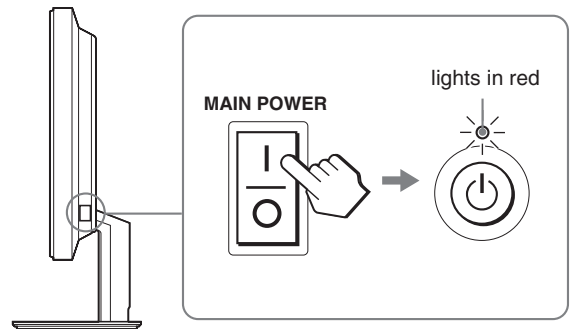

- 2 Press the ⏻ (power) switch on the front right of the monitor.
The ⏻ (power) indicator lights up in green.

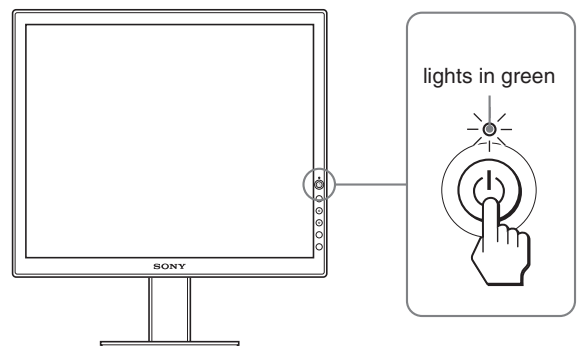

3 Turn on the computer.

The installation of your monitor is complete. If necessary, use the monitor's controls to adjust the picture (page 10).

If no picture appears on your screen

- Check that the power cord and the video signal cable are properly connected.
- **If “NO INPUT SIGNAL” appears on the screen:**
The computer is in the power saving mode. Try pressing any key on the keyboard or moving the mouse.
- **If “CABLE DISCONNECTED” appears on the screen:**
Check that the video signal cable is properly connected.
- **If “OUT OF RANGE” appears on the screen:**
Reconnect the old monitor. Then adjust the computer's graphics board within the following ranges.

	SDM-S53	SDM-S73/S93
Horizontal frequency	28–61 kHz	28–80 kHz
Vertical frequency	48–75 Hz	48–75 Hz
Resolution	1024 × 768 or less	1280 × 1024 or less

For more information about the on-screen messages, see “Trouble symptoms and remedies” on page 18.

No need for specific drivers

The monitor complies with the “DDC” Plug & Play standard and automatically detects all the monitor's information. No specific driver needs to be installed to the computer.

The first time you turn on your computer after connecting the monitor, the setup Wizard may appear on the screen. In this case, follow the on-screen instructions. The Plug & Play monitor is automatically selected so that you can use this monitor.

The vertical frequency turns to 60 Hz.

Since flickers are unobtrusive on the monitor, you can use it as it is. You do not need to set the vertical frequency to any particular high value.

Setup 5: Adjusting the tilt

This display can be adjusted within the angles shown below.

Grasp the sides of the LCD panel, then adjust screen angles.

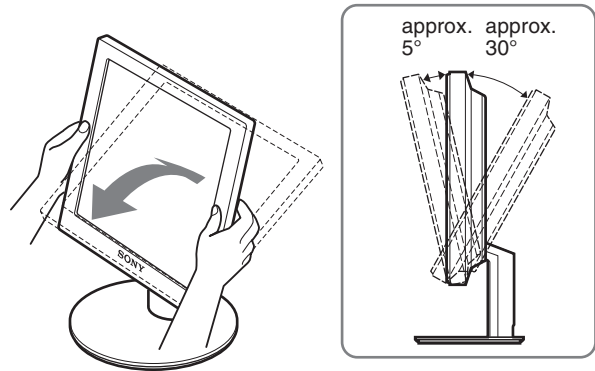

SDM-S93 only

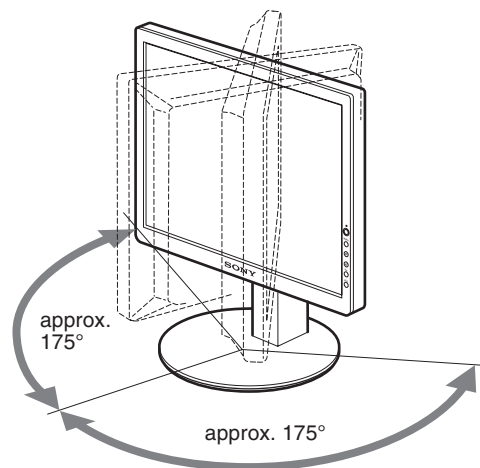

To use the monitor comfortably

Adjust the viewing angle of your monitor according to the height of your desk and chair, and so that light is not reflected from the screen to your eyes.

Note

When adjusting the screen tilt and height, proceed slowly and carefully, being sure not to hit the monitor against the desk.

Customizing Your Monitor

Before making adjustments

Connect the monitor and the computer, and turn them on. For the best results, wait for at least 30 minutes before making adjustments.

You can make numerous adjustments to your monitor using the on-screen menu.

Navigating the menu

Press the MENU button to display the main menu on your screen. See page 11 for more information on using the MENU button.

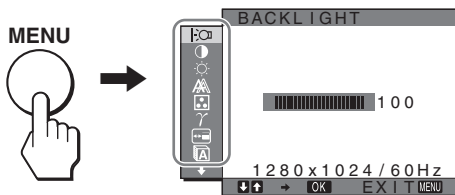

Use the \downarrow/\uparrow and OK buttons to select the icons in the above main menu illustration. The following [1]~[9] menu appears. Keep pressing \downarrow to scroll down until the icons in menu [9] appear. See page 11 for more information on using the \downarrow/\uparrow and OK buttons.

1 BACKLIGHT (page 11)

Select the BACKLIGHT menu to adjust the brightness of the backlight.

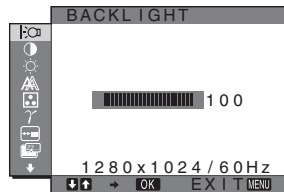

2 CONTRAST (page 11)

Select the CONTRAST menu to adjust the picture contrast.

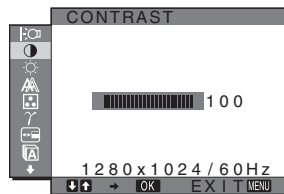

3 BRIGHTNESS (page 11)

Select the BRIGHTNESS menu to adjust the picture brightness (black level).

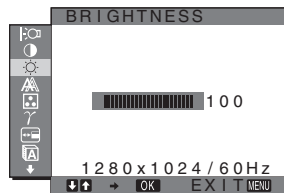

4 SCREEN (page 12)

Select the SCREEN menu to adjust the picture's sharpness (phase/pitch) or its centering (horizontal/vertical position).

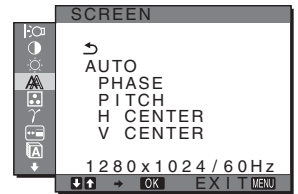

5 COLOR (page 13)

Select the COLOR menu to adjust the color temperature of the picture. This adjusts the tone of the screen.

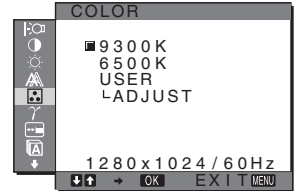

6 GAMMA (page 14)

Select the GAMMA menu to change the picture's color shade setting.

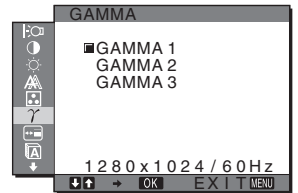

7 MENU POSITION (page 14)

Select the MENU POSITION to change the on-screen menu position.

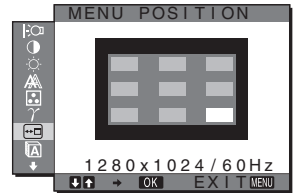

8 LANGUAGE (page 14)

Select LANGUAGE to change the language used on menus or messages.



9 RESET (page 14)

Reset the adjustments to the default settings.

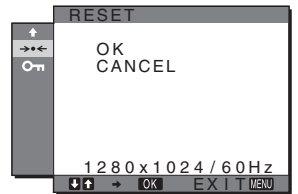

10 MENU LOCK (page 14)

Lock the control of buttons to prevent accidental adjustments or resetting.

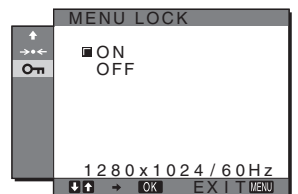

■ Using the MENU, ↓/↑, and OK buttons

1 Display the main menu.

Press the MENU button to display the main menu on your screen.



2 Select the menu you want to adjust.

Press the ↓/↑ buttons to display the desired menu. Press the OK button to select the menu item.

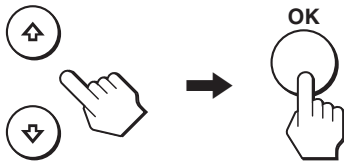

3 Adjust the menu.

Press the ↓/↑ buttons to make the adjustment, then press the OK button.

When you press the OK button, the setting is stored, then the display returns to the previous menu.

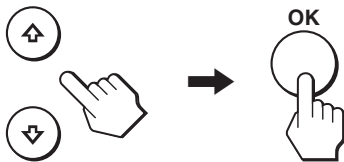

4 Close the menu.

Press the MENU button once to return to normal viewing. If no buttons are pressed, the menu closes automatically after about 30 seconds.



■ Resetting the adjustments to the default settings

You can reset the adjustments using the RESET menu. For more information about resetting the adjustments, see →← (RESET) on page 14.

☰ Adjusting the backlight (BACKLIGHT)

If the screen is too bright, adjust the backlight and make the screen easier to see.

Note

The backlight cannot be adjusted when the ECO mode is set to HIGH, MIDDLE, or LOW (page 15).

1 Press the MENU button.

The main menu appears on the screen.

2 Press the ↓/↑ buttons to select ☰ (BACKLIGHT) and press the OK button.

The BACKLIGHT menu appears on the screen.

3 Press the ↓/↑ buttons to adjust the light level and press the OK button.

● Adjusting the contrast (CONTRAST)

Adjust the picture contrast.

Note

The contrast cannot be adjusted when the ECO mode is set to HIGH, MIDDLE, or LOW (page 15).

1 Press the MENU button.

The main menu appears on the screen.

2 Press the ↓/↑ buttons to select ● (CONTRAST) and press the OK button.

The CONTRAST menu appears on the screen.

3 Press the ↓/↑ buttons to adjust the contrast and press the OK button.

☀ Adjusting the black level of an image (BRIGHTNESS)

Adjust the picture brightness (black level).

Note

The brightness cannot be adjusted when the ECO mode is set to HIGH, MIDDLE, or LOW (page 15).

1 Press the MENU button.

The main menu appears on the screen.

2 Press the ↓/↑ buttons to select ☀ (BRIGHTNESS) and press the OK button.

The BRIGHTNESS menu appears on the screen.

3 Press the ↓/↑ buttons to adjust the brightness and press the OK button.

Adjusting the picture's sharpness and centering (SCREEN)

Automatic picture quality adjustment function

When the monitor receives an input signal, it automatically adjusts the picture's position and sharpness (phase/pitch), and ensures that a clear picture appears on the screen (page 15).

Note

While the automatic picture quality adjustment function is activated, only the  (power) switch will operate.

If the automatic picture quality adjustment function of this monitor seems to not completely adjust the picture

You can make further automatic adjustment of the picture quality for the current input signal. (See AUTO below.)

If you still need to make further adjustments to the picture quality

You can manually adjust the picture's sharpness (phase/pitch) and position (horizontal/vertical position).

These adjustments are stored in memory and automatically recalled when the display receives the same input signal.

These settings may have to be repeated if you change the input signal after reconnecting your computer.

Make further automatic adjustments to the picture quality for the current input signal (AUTO)

1 Press the MENU button.

The main menu appears on the screen.

2 Press the / buttons to select (SCREEN) and press the OK button.

The SCREEN menu appears on the screen.

3 Press the / buttons to select AUTO and press the OK button.

Make the appropriate adjustments of the screen's phase, pitch and horizontal/vertical position for the current input signal and store them.

4 Press the / buttons to select and press the OK button.

Return to the menu screen.

Adjust the picture's sharpness manually (PHASE/PITCH)

You can adjust the picture's sharpness as follows.

1 Set the resolution to 1024 × 768 (SDM-S53) 1280 × 1024 (SDM-S73/S93) on the computer.

2 Load the CD-ROM.

3 Start the CD-ROM, select the area and model, and display the test pattern.

For Windows

Click [Utility] → [Windows]/[Win Utility.exe].

For Macintosh

Click [Utility] → [Mac]/[Mac Utility].

4 Press the MENU button.

The main menu appears on the screen.

5 Press the / buttons to select (SCREEN) and press the OK button.

The SCREEN menu appears on the screen.

6 Press the / buttons to select PHASE and press the OK button.

The PHASE menu appears on the screen.

7 Press the / buttons until the horizontal stripes are at a minimum.

Adjust so that the horizontal stripes are at a minimum.

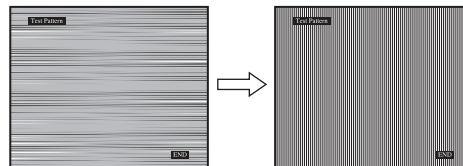

8 Press the OK button.

The main menu appears on the screen.

If vertical stripes are observed over the entire screen, adjust pitch by the following steps.

9 Press the / buttons to select PITCH and press the OK button.

The PITCH menu appears on the screen.

10 Press the / buttons until the vertical stripes disappear.

Adjust so that the vertical stripes disappear.

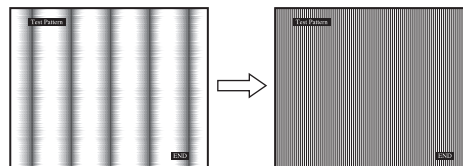

11 Click **END** on the screen to turn off the test pattern.

12 Press the OK button.



Return to the SCREEN menu.

13 Press the / buttons to select and press the OK button.

Return to the menu screen.

■ Adjust the picture's position manually (H CENTER/V CENTER)

If the picture is not in the center of the screen, adjust the picture's centering as follows.

- 1 Set the resolution to 1024 × 768 (SDM-S53) 1280 × 1024 (SDM-S73/S93) on the computer.**
- 2 Load the CD-ROM.**
- 3 Start the CD-ROM, select the area and model, and display the test pattern.**
For Windows
Click [Utility] → [Windows]/[Win Utility.exe].
For Macintosh
Click [Utility] → [Mac]/[Mac Utility].
- 4 Press the MENU button.**
The main menu appears on the screen.
- 5 Press the ↓/↑ buttons to select  (SCREEN) and press the OK button.**
The SCREEN menu appears on the screen.
- 6 Press the ↓/↑ buttons to select H CENTER or V CENTER and press the OK button.**
The H CENTER or V CENTER menu appears on the screen.
- 7 Press the ↓/↑ buttons to center the test pattern in the screen.**
- 8 Click [END] on the screen to turn off the test pattern.**
- 9 Press the OK button.**
Return to the SCREEN menu.
- 10 Press the ↓/↑ buttons to select  and press the OK button.**
Return to the menu screen.

⦿ Adjusting the color temperature (COLOR)

You can select the color level of the picture's white color field from the default color temperature settings. Also, if necessary, you can fine tune the color temperature.

- 1 Press the MENU button.**
The main menu appears on the screen.
- 2 Press the ↓/↑ buttons to select  (COLOR) and press the OK button.**
The COLOR menu appears on the screen.
- 3 Press the ↓/↑ buttons to select the desired color temperature and press the OK button.**
Whites will change from a bluish hue to reddish hue as the temperature is lowered from 9300K to 6500K.

■ Fine tuning the color temperature (USER ADJUSTMENT)

- 1 Press the MENU button.**
The main menu appears on the screen.
- 2 Press the ↓/↑ buttons to select  (COLOR) and press the OK button.**
The COLOR menu appears on the screen.
- 3 Press the ↓/↑ buttons to select "ADJUST" and press the OK button.**
The fine tuning menu for color temperature appears on the screen.

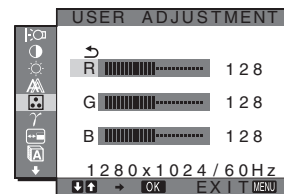

- 4 Press the ↓/↑ buttons to select R (Red) or B (Blue) and press the OK button. Then press the ↓/↑ buttons to adjust the color temperature and press the OK button.**
Since this adjustment changes the color temperature by increasing or decreasing the R and B components with respect to G (green), the G component is fixed.
- 5 Press the ↓/↑ buttons to select , then press the OK button.**
The new color setting is stored in memory for USER ADJUSTMENT and automatically recalled whenever USER is selected.
The main menu appears on the screen.

Changing the gamma setting (GAMMA)

You can associate the picture's color shade on the screen with the picture's original color shade.

- 1 Press the MENU button.**
The main menu appears on the screen.
- 2 Press the ↓/↑ buttons to select  (GAMMA) and press the OK button.**
The GAMMA menu appears on the screen.
- 3 Press the ↓/↑ buttons to select the desired mode and press the OK button.**

Changing the menu's position (MENU POSITION)

You can change the menu position if it is blocking an image on the screen.

- 1 Press the MENU button.**
The main menu appears on the screen.
- 2 Press the ↓/↑ buttons to select  (MENU POSITION) and press the OK button.**
The MENU POSITION menu appears on the screen.
- 3 Press the ↓/↑ buttons to select the desired position and press the OK button.**
You can choose one of 9 positions where the menu will appear.



Selecting the on-screen menu language (LANGUAGE)

You can change the language used on menus or messages displayed on this monitor.

- 1 Press the MENU button.**
The main menu appears on the screen.
- 2 Press the ↓/↑ buttons to select  (LANGUAGE) and press the OK button.**
The LANGUAGE menu appears on the screen.
- 3 Press the ↓/↑ buttons to select a language and press the OK button.**
 - ENGLISH
 - FRANÇAIS: French
 - DEUTSCH: German
 - ESPAÑOL: Spanish
 - ITALIANO: Italian
 - NEDERLANDS: Dutch
 - SVENSKA: Swedish
 - РУССКИЙ: Russian
 - 日本語: Japanese
 - 中文: Chinese







Resetting the adjustment data to the defaults (RESET)

Reset the adjustments to the default settings.

- 1 Press the MENU button.**
The main menu appears on the screen.
- 2 Press the ↓/↑ buttons to select  (RESET) and press the OK button.**
The RESET menu appears on the screen.
- 3 Press the ↓/↑ buttons to select the desired mode and press the OK button.**
 - OK: To reset all of the adjustment data to the default settings. Note that the  (LANGUAGE) setting is not reset by this method.
 - CANCEL: To cancel resetting and return to the menu screen.

Locking the menus and controls (MENU LOCK)

Lock the control of buttons to prevent accidental adjustments or resetting.

- 1 Press the MENU button.**
The main menu appears on the screen.
- 2 Press the ↓/↑ buttons to select  (MENU LOCK) and press the OK button.**
The MENU LOCK menu appears on the screen.
- 3 Press the ↓/↑ buttons to select ON or OFF and press the OK button.**
 - ON: Only the  (power) switch will operate. If you attempt any other operation, the  (MENU LOCK) icon appears on the screen.
 - OFF: Set  (MENU LOCK) to off. If  (MENU LOCK) has been set to ON, when you press the MENU button,  (MENU LOCK) is automatically selected.

Technical Features

Power saving function

This monitor meets the power-saving guidelines set by VESA, ENERGY STAR, and NUTEK. If the monitor is connected to a computer or video graphics board that is DPMS (Display Power Management Signaling) compliant, the monitor will automatically reduce power consumption as shown below.

SDM-S53

Power mode	Power consumption	⏻ (power) indicator
normal operation	25 W (max.)	green
active off* (deep sleep)**	1 W (max.)	orange
power off	1 W (max.)	red
main power off	0 W	off

SDM-S73

Power mode	Power consumption	⏻ (power) indicator
normal operation	45 W (max.)	green
active off* (deep sleep)**	1 W (max.)	orange
power off	1 W (max.)	red
main power off	0 W	off

SDM-S93

Power mode	Power consumption	⏻ (power) indicator
normal operation	50 W (max.)	green
active off* (deep sleep)**	1 W (max.)	orange
power off	1 W (max.)	red
main power off	0 W	off

* When your computer enters the “active off” mode, the input signal is cut and NO INPUT SIGNAL appears on the screen. After 5 seconds, the monitor enters the power saving mode.

** “deep sleep” is the power saving mode defined by the Environmental Protection Agency.

Reducing the power consumption (ECO mode)

If you press the ECO button on the front of the monitor repeatedly, you can select the screen brightness.

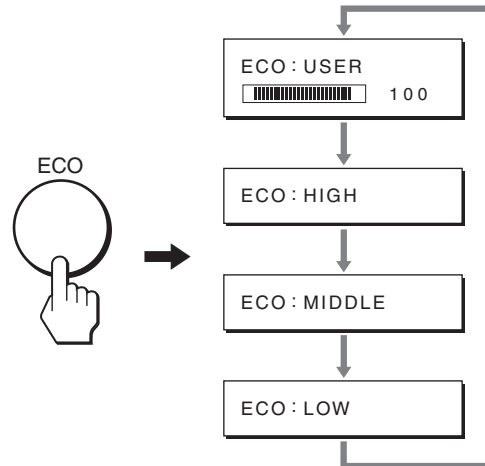

Each mode appears on the screen and the screen brightness is reduced according to the mode. The menu automatically disappears after about 5 seconds.

Screen brightness and power consumption are reduced as the mode changes from HIGH to MIDDLE to LOW.

The default setting of the screen brightness is set to “USER”. If you select “USER”, you can adjust the backlight level by pressing the ↓/↑ buttons, the same as when you select BACKLIGHT using the menu.

NOTE

Only while the ECO mode is set to “USER”, are the BACKLIGHT, CONTRAST, and BRIGHTNESS items of the menu available (page 11).

GB

Automatic picture quality adjustment function

When the monitor receives an input signal, it automatically adjusts the picture’s position and sharpness (phase/pitch), and ensures that a clear picture appears on the screen.

The factory preset mode

When the monitor receives an input signal, it automatically matches the signal to one of the factory preset modes stored in the monitor’s memory to provide a high quality picture at the center of the screen. If the input signal matches the factory preset mode, the picture appears on the screen automatically with the appropriate default adjustments.

If input signals do not match one of the factory preset modes

When the monitor receives an input signal that does not match one of the factory preset modes, the automatic picture quality adjustment function of this monitor is activated to ensure that a clear picture always appears on the screen (within the following monitor frequency ranges):

(continued)

Horizontal frequency: 28–61 kHz (SDM-S53)
28–80 kHz (SDM-S73/S93)

Vertical frequency: 48–75 Hz

Consequently, the first time the monitor receives input signals that do not match one of the factory preset modes, the monitor may take a longer time than normal to display the picture on the screen. This adjustment data is automatically stored in memory so that next time, the monitor will function in the same way as when the monitor receives the signals that match one of the factory preset modes.

If you adjust the phase, pitch, and picture position manually

For some input signals, the automatic picture quality adjustment function of this monitor may not completely adjust the picture position, phase, and pitch. In this case, you can set these adjustments manually (page 12). If you set these adjustments manually, they are stored in memory as user modes and automatically recalled whenever the monitor receives the same input signals.

Note

While the automatic picture quality adjustment function is activated, only the  (power) switch will operate.

Troubleshooting

Before contacting technical support, refer to this section.

On-screen messages

If there is something wrong with the input signal, one of the following messages appears on the screen. To solve the problem, see “Trouble symptoms and remedies” on page 18.

If “OUT OF RANGE” appears on the screen

This indicates that the input signal is not supported by the monitor’s specifications. Check the following items. For more information about on-screen messages, see “Trouble symptoms and remedies” on page 18.

If “xxx.x kHz/xxx Hz” is displayed

This indicates that either the horizontal or vertical frequency is not supported by the monitor’s specifications. The figures indicate the horizontal and vertical frequencies of the current input signal.

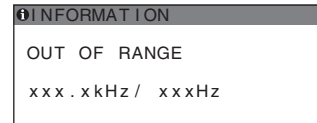

If “RESOLUTION > 1024 × 768” is displayed (SDM-S53)

This indicates that the resolution is not supported by the monitor’s specifications (1024 × 768 or less).

If “RESOLUTION > 1280 × 1024” is displayed (SDM-S73/S93)

This indicates that the resolution is not supported by the monitor’s specifications (1280 × 1024 or less).

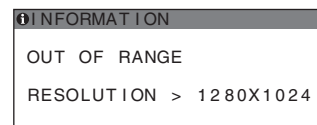

If “NO INPUT SIGNAL” appears on the screen

This indicates that no signal is being input.

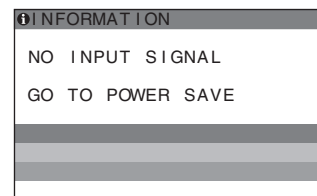

“GO TO POWER SAVE”

The monitor will enter the power saving mode after about 5 seconds from the time the message is displayed.





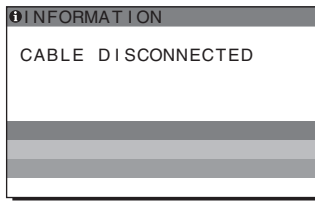

If “CABLE DISCONNECTED” appears on the screen

This indicates that the video signal cable has been disconnected.



Trouble symptoms and remedies

If a problem occurs as a result of a connected computer or other equipment, refer to the connected computer/equipment's instruction manual. Use the self-diagnosis function (page 20) if the following recommendations do not resolve the problem.

Symptom	Check these items
No picture	
If the  (power) indicator is not lit, or if the  (power) indicator will not light up when the  (power) switch is pressed,	<ul style="list-style-type: none"> • Check that the power cord is properly connected. • Check that the monitor's MAIN POWER switch is on (page 8).
If the  (power) indicator turns on in red,	<ul style="list-style-type: none"> • Check that the  (power) switch is on.
If the  (power) indicator is green or flashing orange,	<ul style="list-style-type: none"> • Use the self-diagnosis function (page 20).
If CABLE DISCONNECTED appears on the screen,	<ul style="list-style-type: none"> • Check that the video signal cable is properly connected and all plugs are firmly seated in their sockets (page 6). • Check that the video input connector's pins are not bent or pushed in. • A non-supplied video signal cable is connected. If you connect a non-supplied video signal cable, CABLE DISCONNECTED may appear on the screen. This is not a malfunction.
If NO INPUT SIGNAL appears on the screen, or the  (power) indicator is either orange or alternating between green and orange,	<ul style="list-style-type: none"> • Check that the video signal cable is properly connected and all plugs are firmly seated in their sockets (page 6). • Check that the video input connector's pins are not bent or pushed in. ■ Problems caused by a computer or other equipment connected, and not caused by the monitor <ul style="list-style-type: none"> • The computer is in the power saving mode. Try pressing any key on the keyboard or moving the mouse. • Check that your graphics board is installed properly. • Check that the computer's power is on. • Restart the computer.
If OUT OF RANGE appears on the screen (page 16),	<ul style="list-style-type: none"> ■ Problems caused by a computer or other equipment connected, and not caused by the monitor <ul style="list-style-type: none"> • Check that the video frequency range is within that specified for the monitor. If you replaced an old monitor with this monitor, reconnect the old monitor and adjust the computer's graphics board within the following ranges: Horizontal: 28 – 61 kHz (SDM-S53), 28 – 80 kHz (SDM-S73/S93) Vertical: 48 – 75 Hz Resolution: 1024 × 768 or less (SDM-S53), 1280 × 1024 or less (SDM-S73/S93)
If using Windows,	<ul style="list-style-type: none"> • If you replaced an old monitor with this monitor, reconnect the old monitor and do the following. Select "SONY" from the "Manufacturers" list and select "SDM-S53," "SDM-S73" or "SDM-S93" from the "Models" list in the Windows device selection screen. If the model name of this monitor does not appear in the "Models" list, try "Plug & Play."
If using a Macintosh system,	<ul style="list-style-type: none"> • When connecting a Macintosh computer, use an adapter (not supplied) if necessary. Connect the adapter to the computer before connecting the video signal cable.
Picture flickers, bounces, oscillates, or is scrambled	<ul style="list-style-type: none"> • Adjust the pitch and phase (page 12). • Isolate and eliminate any potential sources of electric or magnetic fields such as other monitors, laser printers, electric fans, fluorescent lighting, or televisions. • Try plugging the monitor into a different AC outlet, preferably on a different circuit. ■ Problems caused by a computer or other equipment connected, and not caused by the monitor <ul style="list-style-type: none"> • Check your graphics board manual for the proper monitor setting. • Confirm that the graphics mode (VESA, Macintosh 19" Color, etc.) and the frequency of the input signal are supported by this monitor. Even if the frequency is within the proper range, some graphics boards may have a sync pulse that is too narrow for the monitor to sync correctly. • Adjust the computer's refresh rate (vertical frequency) to obtain the best possible picture.

Symptom	Check these items
Picture is fuzzy	<ul style="list-style-type: none"> • Adjust the brightness and contrast (page 11). • Adjust the pitch and phase (page 12). <p>■ Problems caused by a computer or other equipment connected, and not caused by the monitor</p> <ul style="list-style-type: none"> • Set the resolution to 1024 × 768 (SDM-S53), 1280 × 1024 (SDM-S73/S93) on your computer.
Picture is ghosting	<ul style="list-style-type: none"> • Eliminate the use of video cable extensions and/or video switch boxes. • Check that all plugs are firmly seated in their sockets.
Picture is not centered or sized properly	<ul style="list-style-type: none"> • Adjust the pitch and phase (page 12). • Adjust the picture position (page 13). Note that some video modes do not fill the screen to the edges.
Picture is too small	<p>■ Problems caused by a computer or other equipment connected, and not caused by the monitor</p> <ul style="list-style-type: none"> • Set the resolution to 1024 × 768 (SDM-S53), 1280 × 1024 (SDM-S73/S93) on your computer.
Picture is dark	<ul style="list-style-type: none"> • Adjust the backlight (page 11). • Adjust the brightness (page 11). • Adjust the gamma using “Gamma” (page 14). • It takes a few minutes for the display to become bright after turning on the monitor. • The screen might turn darker, depends on ECO mode you selected.
Wavy or elliptical pattern (moire) is visible	<ul style="list-style-type: none"> • Adjust the pitch and phase (page 12).
Color is not uniform	<ul style="list-style-type: none"> • Adjust the pitch and phase (page 12).
White does not look white	<ul style="list-style-type: none"> • Adjust the color temperature (page 13).
Monitor buttons do not operate (O₁ appears on the screen)	<ul style="list-style-type: none"> • If “MENU LOCK” is set to ON, set it to OFF (page 14).
The monitor turns off after a while	<p>■ Problems caused by the connected computer or other equipment</p> <ul style="list-style-type: none"> • Set the computer’s power saving setting to off.
After turnig off the main power, the ⏻ (power) indicator stays bright for a while	<ul style="list-style-type: none"> • When the main power is on but the ⏻ (power) switch is not pressed, or when the monitor is in the power saving mode, if you turn the MAIN POWER switch off, the ⏻ (power) indicator may not turn off right away. This is not a malfunction.

Displaying this monitor's information

While the monitor is receiving a video signal, press and hold the MENU button for more than 5 seconds until the information box appears.

Press the MENU button again to make the box disappear.

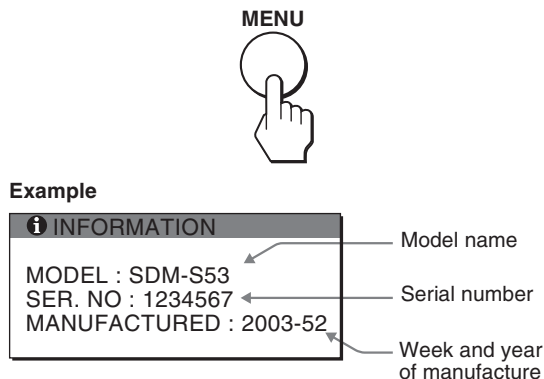

If any problem persists, call your authorized Sony dealer and give the following information:

- Model name: SDM-S53 or SDM-S73 or SDM-S93
- Serial number
- Detailed description of the problem
- Date of purchase
- Name and specifications of your computer and graphics board

Self-diagnosis function

This monitor is equipped with a self-diagnosis function. If there is a problem with your monitor or computer(s), the screen will go blank and the ⏻ (power) indicator will either light up in green or flash orange. If the ⏻ (power) indicator is lit in orange, the computer is in power saving mode. Try pressing any key on the keyboard or moving the mouse.

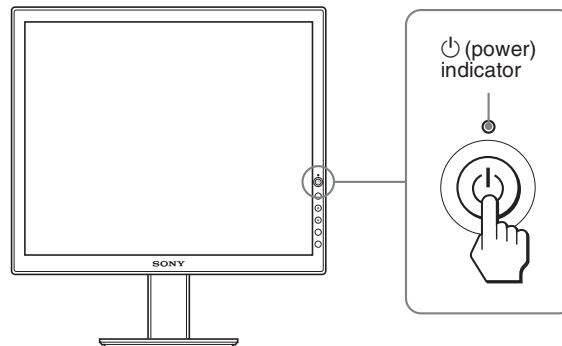

If the picture disappears from the screen and the ⏻ (power) indicator is green

- 1 Turn off the ⏻ (power) switch and disconnect the video signal cables from the monitor.
- 2 Turn the monitor on by pressing the ⏻ (power) switch.

If all four color bars appear (white, red, green, blue), the monitor is working properly. Reconnect the video signal cables and check the condition of your computer(s).

If the color bars do not appear, there is a potential monitor failure. Inform your authorized Sony dealer of the monitor's condition.

If the picture disappears from the screen and the ⏻ (power) indicator is flashing orange

Press the ⏻ (power) switch twice to turn the monitor off and then on.

If the ⏻ (power) indicator lights up in green, the monitor is working properly.

If the ⏻ (power) indicator is still flashing, there is a potential monitor failure. Count the number of seconds between orange flashes of the ⏻ (power) indicator and inform your authorized Sony dealer of the monitor's condition. Be sure to note the model name and serial number of your monitor. Also note the make and model of your computer and graphics board.

Specifications

SDM-S53

LCD panel	Panel type: a-Si TFT Active Matrix Picture size: 15.0 inch
Input signal format	RGB operating frequency* Horizontal: 28 – 61 kHz Vertical: 48 – 75 Hz
Resolution	Horizontal: Max.1024 dots Vertical: Max.768 lines
Input signal levels	RGB video signal 0.7 Vp-p, 75 Ω positive SYNC signal TTL level, 2.2 kΩ positive or negative (Separate horizontal and vertical, or composite sync) 0.3 Vp-p, 75Ω, negative (Sync on green)
Power requirements	100 – 240 V, 50 – 60 Hz, Max. 0.6 A
Power consumption	Max. 25 W
Operating temperature	5 – 35 °C
Dimensions (width/height/depth)	Display (upright): Approx. 339 × 370 × 186 mm (13 ³ / ₈ × 14 ⁵ / ₈ × 7 ³ / ₈ inches) (with stand) Approx. 339 × 275 × 53 mm (13 ³ / ₈ × 10 ⁷ / ₈ × 2 ¹ / ₈ inches) (without stand)
Mass	Approx. 3.7 kg (8 lb 2 oz) (with stand) Approx. 2.7 kg (5 lb 15 oz) (without stand)
Plug & Play	DDC2B
Accessories	See page 6.

SDM-S73/S93

LCD panel	Panel type: a-Si TFT Active Matrix Picture size: 17.0 inch (SDM-S73) Picture size: 19.0 inch (SDM-S93)
Input signal format	RGB operating frequency* Horizontal: 28 – 80 kHz Vertical: 48 – 75 Hz
Resolution	Horizontal: Max.1280 dots Vertical: Max.1024 lines
Input signal levels	RGB video signal 0.7 Vp-p, 75 Ω positive SYNC signal TTL level, 2.2 kΩ positive or negative (Separate horizontal and vertical, or composite sync) 0.3 Vp-p, 75Ω, negative (Sync on green)
Power requirements	100 – 240 V, 50 – 60 Hz, Max. 1.0 A
Power consumption	Max. 45 W (SDM-S73) Max. 50 W (SDM-S93)
Operating temperature	5 – 35 °C
Dimensions (width/height/depth)	Display (upright): Approx. 367 × 411 × 215 mm (14 ¹ / ₂ × 16 ¹ / ₄ × 8 ¹ / ₂ inches) (with stand) (SDM-S73) Approx. 412 × 445 × 234 mm (16 ¹ / ₄ × 17 ⁵ / ₈ × 9 ¹ / ₄ inches) (with stand) (SDM-S93) Approx. 367 × 315 × 60 mm (14 ¹ / ₂ × 12 ¹ / ₂ × 2 ³ / ₈ inches) (without stand) (SDM-S73) Approx. 412 × 350 × 64 mm (16 ¹ / ₄ × 13 ⁷ / ₈ × 2 ⁵ / ₈ inches) (without stand) (SDM-S93)
Mass	Approx. 5.4 kg (11 lb 14 oz) (with stand) (SDM-S73) Approx. 6.6 kg (14 lb 8 oz) (with stand) (SDM-S93) Approx. 4.1 kg (9lb) (without stand) (SDM-S73) Approx. 5.2 kg (11 lb 7 oz) (without stand) (SDM-S93)
Plug & Play	DDC2B
Accessories	See page 6.

- * Recommended horizontal and vertical timing condition
- Horizontal sync width duty should be more than 4.8% of total horizontal time or 0.8 μs, whichever is larger.
 - Horizontal blanking width should be more than 2.5 μsec.
 - Vertical blanking width should be more than 450 μsec.

Design and specifications are subject to change without notice.

TCO'99 Eco-document

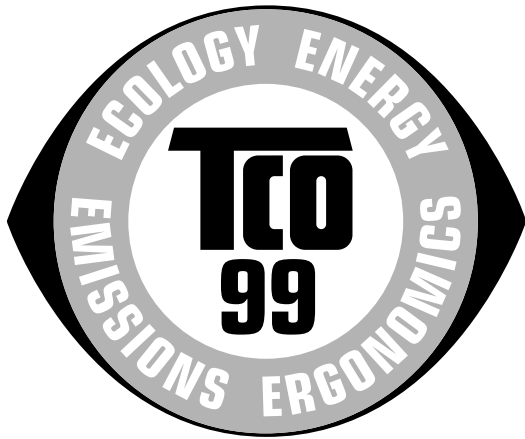

■ Congratulations!

You have just purchased a TCO'99 approved and labelled product! Your choice has provided you with a product developed for professional use. Your purchase has also contributed to reducing the burden on the environment and also to the further development of environmentally adapted electronics products.

■ Why do we have environmentally labelled computers?

In many countries, environmental labelling has become an established method for encouraging the adaptation of goods and services to the environment. The main problem, as far as computers and other electronics equipment are concerned, is that environmentally harmful substances are used both in the products and during their manufacture. Since it is not so far possible to satisfactorily recycle the majority of electronics equipment, most of these potentially damaging substances sooner or later enter nature.

There are also other characteristics of a computer, such as energy consumption levels, that are important from the viewpoints of both the work (internal) and natural (external) environments. Since all methods of electricity generation have a negative effect on the environment (e.g. acidic and climate-influencing emissions, radioactive waste), it is vital to save energy. Electronics equipment in offices is often left running continuously and thereby consumes a lot of energy.

■ What does labelling involve?

This product meets the requirements for the TCO'99 scheme which provides for international and environmental labelling of personal computers. The labelling scheme was developed as a joint effort by the TCO (The Swedish Confederation of Professional Employees), Svenska Naturskyddsforeningen (The Swedish Society for Nature Conservation) and Statens Energimyndighet (The Swedish National Energy Administration).

Approval requirements cover a wide range of issues: environment, ergonomics, usability, emission of electric and magnetic fields, energy consumption and electrical and fire safety.

The environmental demands impose restrictions on the presence and use of heavy metals, brominated and chlorinated flame retardants, CFCs (freons) and chlorinated solvents, among other things. The product must be prepared for recycling and the manufacturer is obliged to have an environmental policy which must be adhered to in each country where the company implements its operational policy.

The energy requirements include a demand that the computer and/or display, after a certain period of inactivity, shall reduce its power consumption to a lower level in one or more stages. The length of time to reactivate the computer shall be reasonable for the user.

Labelled products must meet strict environmental demands, for example, in respect of the reduction of electric and magnetic fields, physical and visual ergonomics and good usability.

Below you will find a brief summary of the environmental requirements met by this product. The complete environmental criteria document may be ordered from:

TCO Development

SE-114 94 Stockholm, Sweden

Fax: +46 8 782 92 07

Email (Internet): development@tco.se

Current information regarding TCO'99 approved and labelled products may also be obtained via the Internet, using the address: <http://www.tco-info.com/>

■ Environmental requirements

Flame retardants

Flame retardants are present in printed circuit boards, cables, wires, casings and housings. Their purpose is to prevent, or at least to delay the spread of fire. Up to 30% of the plastic in a computer casing can consist of flame retardant substances. Most flame retardants contain bromine or chloride, and those flame retardants are chemically related to another group of environmental toxins, PCBs. Both the flame retardants containing bromine or chloride and the PCBs are suspected of giving rise to severe health effects, including reproductive damage in fish-eating birds and mammals, due to the bio-accumulative* processes. Flame retardants have been found in human blood and researchers fear that disturbances in foetus development may occur.

The relevant TCO'99 demand requires that plastic components weighing more than 25 grams must not contain flame retardants with organically bound bromine or chlorine. Flame retardants are allowed in the printed circuit boards since no substitutes are available.

Cadmium**

Cadmium is present in rechargeable batteries and in the colour-generating layers of certain computer displays. Cadmium damages the nervous system and is toxic in high doses. The relevant TCO'99 requirement states that batteries, the colour-generating layers of display screens and the electrical or electronics components must not contain any cadmium.

Mercury**

Mercury is sometimes found in batteries, relays and switches. It damages the nervous system and is toxic in high doses. The relevant TCO'99 requirement states that batteries may not contain any mercury. It also demands that mercury is not present in any of the electrical or electronics components associated with the labelled unit.

CFCs (freons)

The relevant TCO'99 requirement states that neither CFCs nor HCFCs may be used during the manufacture and assembly of the product. CFCs (freons) are sometimes used for washing printed circuit boards. CFCs break down ozone and thereby damage the ozone layer in the stratosphere, causing increased reception on earth of ultraviolet light with e.g. increased risks of skin cancer (malignant melanoma) as a consequence.

Lead**

Lead can be found in picture tubes, display screens, solders and capacitors. Lead damages the nervous system and in higher doses, causes lead poisoning. The relevant TCO'99 requirement permits the inclusion of lead since no replacement has yet been developed.

* Bio-accumulative is defined as substances which accumulate within living organisms.

** Lead, Cadmium and Mercury are heavy metals which are Bio-accumulative.