

# Video Cassette Recorder

---

## Operating Instructions

For hookup and setup, see the supplied hookup/setup manual.

### Owner's record

The model and serial numbers are located at the rear of the unit. Record these numbers in the spaces provided below. Refer to them whenever you call upon your Sony dealer regarding this product.

Model No. \_\_\_\_\_

Serial No. \_\_\_\_\_

### Declaration of Conformity

Trade Name: SONY  
Model No.: SLV-M11HF  
Responsible Party: Sony Electronics Inc.  
Address: 1 Sony Drive, Park Ridge, NJ.07656 USA  
Telephone No.: 201-930-6970

This device complies with Part 15 of the FCC Rules. Operation is subject to the following two conditions: (1) This device may not cause harmful interference, and (2) this device must accept any interference received, including interference that may cause undesired operation.



Hi-Fi



## SLV-M11HF

## WARNING

To prevent fire or shock hazard, do not expose the unit to rain or moisture.

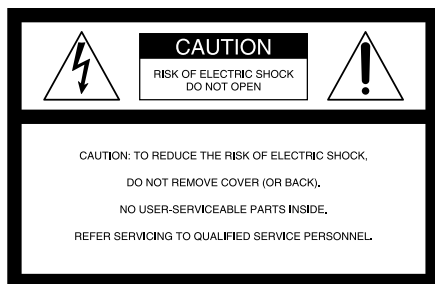

This symbol is intended to alert the user to the presence of uninsulated “dangerous voltage” within the product’s enclosure that may be of sufficient magnitude to constitute a risk of electric shock to persons.



This symbol is intended to alert the user to the presence of important operating and maintenance (servicing) instructions in the literature accompanying the appliance.

### CAUTION

To prevent electric shock, do not use this polarized AC plug with an extension cord, receptacle or other outlet unless the blades can be fully inserted to prevent blade exposure.

### Precautions

#### Safety

- Operate the unit only on 120 V AC, 60 Hz.
- If anything falls into the cabinet, unplug the unit and have it checked by qualified personnel before operating it any further.
- This unit is not disconnected from the AC power source (mains) as long as it is connected to the wall outlet, even if the unit itself has been turned off.
- Unplug the unit from the wall outlet if you do not intend to use it for an extended period of time. To disconnect the cord, pull it out by the plug, never by the cord.
- One blade of the plug is wider than the other for the purpose of safety and will fit into the power outlet only one way. If you are unable to insert the plug fully into the outlet, contact your Sony dealer.

#### Installing

- Allow adequate air circulation to prevent internal heat buildup.
- Do not place the unit on surfaces (rugs, blankets, etc.) or near materials (curtains, draperies) that may block the ventilation slots.

- Do not install the unit near heat sources such as radiators or air ducts, or in a place subject to direct sunlight, excessive dust, mechanical vibration or shock.
- Do not install the unit in an inclined position. It is designed to be operated in a horizontal position only.
- Keep the unit and cassettes away from equipment with strong magnets, such as microwave ovens or large loudspeakers.
- Do not place heavy objects on the unit.
- If the unit is brought directly from a cold to a warm location, moisture may condense inside the VCR and cause damage to the video head and tape. When you first install the unit, or when you move it from a cold to a warm location, wait for about three hours before operating the unit.

### Information

#### For customers in the USA

##### CAUTION

You are cautioned that any changes or modifications not expressly approved in this manual could void your authority to operate this equipment.

##### NOTE:

This equipment has been tested and found to comply with the limits for a Class B digital device, pursuant to Part 15 of the FCC Rules. These limits are designed to provide reasonable protection against harmful interference in a residential installation. This equipment generates, uses, and can radiate radio frequency energy and, if not installed and used in accordance with the instructions, may cause harmful interference to radio communications. However, there is no guarantee that interference will not occur in a particular installation. If this equipment does cause harmful interference to radio or television reception, which can be determined by turning the equipment off and on, the user is encouraged to try to correct the interference by one or more of the following measures:

- Reorient or relocate the receiving antenna.
- Increase the separation between the equipment and receiver.
- Connect the equipment into an outlet on a circuit different from that to which the receiver is connected.
- Consult the dealer or an experienced radio/TV technician for help.

##### Caution

Television programs, films, video tapes and other materials may be copyrighted. Unauthorized recording of such material may be contrary to the provisions of the copyright laws. Also, use of this recorder with cable television transmission may require authorization from the cable television transmission and/or program owner.

---

# Table of contents

## Basic Operations

- 4 Playing a tape
- 7 Recording TV programs
- 11 Locating a channel by Station ID
- 13 Recording TV programs using the VCR Plus+\* GOLD system
- 16 Setting the timer manually

## Additional Operations

- 20 Playing/ searching at various speeds
- 23 Creating a favorite channel list with Station ID
- 26 Setting the recording duration time
- 27 Checking/ changing/ canceling timer settings
- 29 Recording stereo and bilingual programs
- 31 Searching using the index function
- 32 Adjusting the picture
- 34 Changing menu options
- 37 Editing with another VCR

## SmartFile Function

- 39 About the SmartFile function
- 41 Recording using the SmartFile function
- 50 Selecting and playing a program
- 52 Checking the contents of a tape
- 53 Labeling a recorded program and tape
- 58 Protecting a recorded program
- 60 Erasing the data of an unwanted program
- 62 Registering the contents of a recorded tape in the SmartFile label
- 64 Storing program data from the DIRECTV digital satellite receiver (Program Data Download)

## Additional Information

- 66 Troubleshooting
- 69 Specifications
- 70 Index to parts and controls
- 75 Index
- back cover  
Quick reference to using the VCR

\* VCR Plus+, C<sup>3</sup>, ALLSET and PlusCode are trademarks of Gemstar Development Corporation. The VCR Plus+ system is manufactured under license from Gemstar Development Corporation.

# Playing a tape

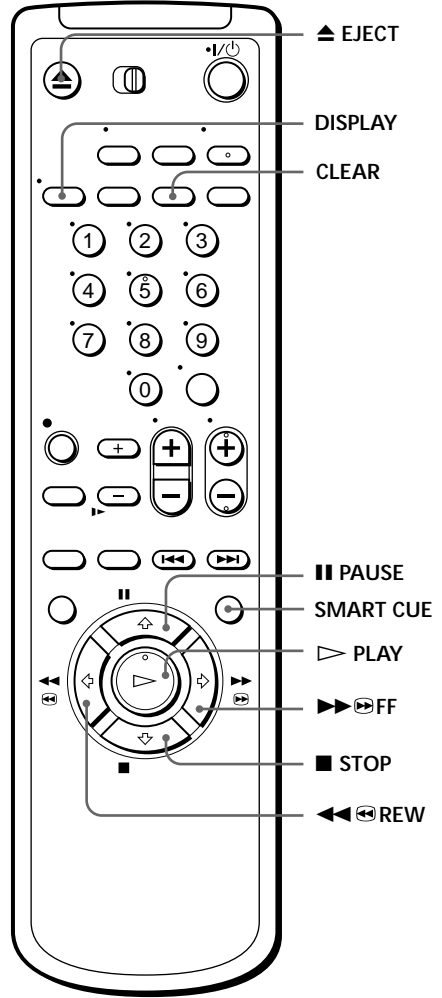

---

**1** Turn on your TV and set it to the video channel.

---

**2** Insert a tape.  
The VCR turns on and starts playing automatically if you insert a tape with its safety tab removed.

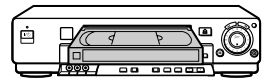

**3**

Press **▷** PLAY.

When the tape reaches the end, it will rewind automatically.

### Additional tasks

To	Press
Stop play	■ STOP
Pause play	PAUSE
Resume play after pause	PAUSE or ▷ PLAY
Fast-forward the tape	▶▶▶ FF during stop
Rewind the tape	◀◀◀ REW during stop
Eject the tape	▲ EJECT

### To skip playback

You can skip a portion of playback you don't want to watch such as a commercial and restart playback by pressing a single button.

- 1** Press SMART CUE during playback of the scene you want to skip. The VCR starts searching.
- 2** Press SMART CUE again when you find the scene you want to watch. The VCR stops searching, rewinds a few seconds, then resumes normal playback.

If you press and hold SMART CUE while the VCR is skip searching, the VCR will stop searching, and continue rewinding until you release SMART CUE.

#### Tip

- You can change the length of rewinding time on the ADVANCED OPTIONS menu. For details, see page 35.

continued

---

## Playing a tape (continued)

### To use the time counter

At the point on the tape that you want to find later, press CLEAR. The counter in the display window resets to "0:00:00". Search for the point afterwards by referring to the counter.



To display the counter on the TV screen, press DISPLAY.

### Notes

- Tapes recorded in the LP mode on other VCRs can be played back on this VCR but the picture quality cannot be guaranteed.
- While setting the menu on the TV screen, you cannot use ▷ PLAY, ■ PAUSE, ►► FF, ◀◀ REW, or ■ STOP buttons.
- The counter resets to "0:00:00" whenever a tape is reinserted.
- The counter stops counting when it comes to a portion with no recording.

# Recording TV programs

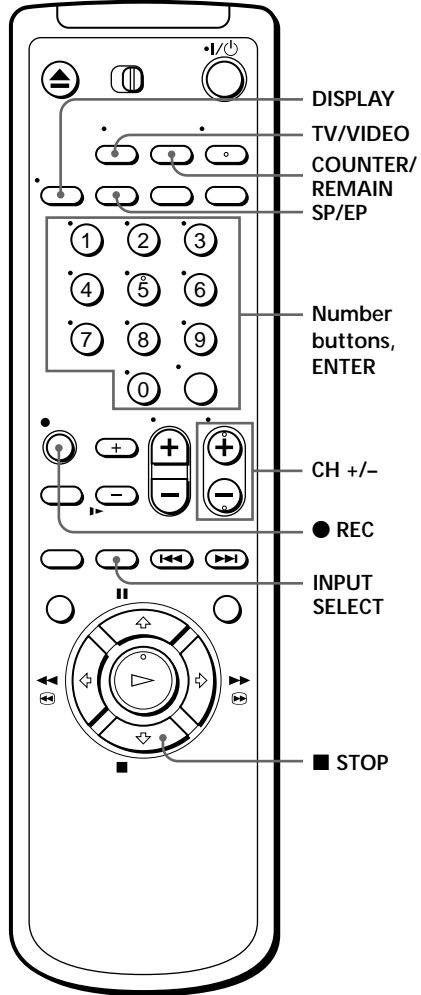

- 1** Turn on your TV and set it to the video channel.  
To record from a cable box, turn it on.
- 2** Insert a tape with its safety tab in place.

continued

## Recording TV programs (continued)

- 3**  Press INPUT SELECT until a channel number appears in the display window.



- 4**  Press CH +/- to select the channel you want to record.



- 5**  Press SP/EP to select the tape speed, SP or EP.  
EP (Extended Play) provides recording time three times as long as SP (Standard Play), however, SP produces better picture and audio quality.

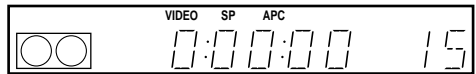

- 6**  Press ● REC to start recording.  
The recording indicator lights up red in the display window.

Recording indicator

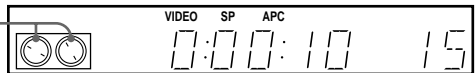

**To stop recording**

Press ■ STOP.



### To check the remaining tape length

Press DISPLAY. The white bar indicates the approximate length of tape remaining. With the display on, press COUNTER/REMAIN to check the remaining time. Each time you press COUNTER/REMAIN, the time counter and the remaining tape length appear alternately. The remaining tape length with the  indicator also appears in the display window.

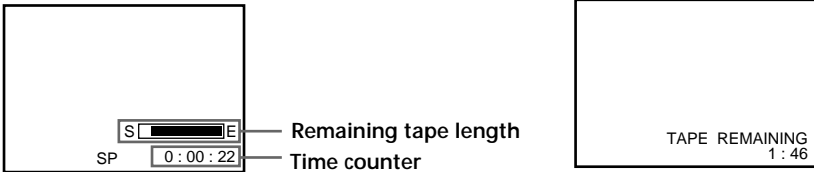

To check the remaining tape length of a T-140 or T-180 tape, set TAPE SELECT in the ADVANCED OPTIONS menu to 180. (For details, see page35.)

### To watch another TV program while recording

- 1 Press TV/VIDEO to turn off the VIDEO indicator in the display window.
- 2 If the TV is connected to the VCR's LINE OUT jacks, set the TV to TV input; if not, skip this step.
- 3 Select another channel on the TV.

### To select the channel using the shuttle ring

To select a channel in step 4 above, you can also use the shuttle ring. During stop, turn the shuttle ring clockwise for higher channels or counterclockwise for lower channels. The VCR switches the channel in the preset order.

### To save a recording

To prevent accidental erasure, break off the safety tab as illustrated. To record on a tape again, cover the tab hole with adhesive tape.

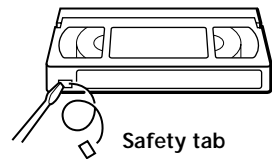

continued

---

## **Recording TV programs (continued)**

### **Tips**

- To select a channel, you can use the number buttons on the remote commander. Enter the channel number, then press ENTER.
- You can select a video source from the LINE-1 IN or LINE-2 IN jacks using the INPUT SELECT button.
- The display appears on the TV screen indicating information about the tape, but the information won't be recorded on the tape.
- If you don't want to watch TV while recording, you can turn off the TV. When using a cable box, make sure to leave it on.

### **Notes**

- The remaining tape length may not be indicated accurately for short tapes such as T-20 or T-30, or tapes recorded in the LP mode.
- The display does not appear during still (pause) mode or slow-motion playback.
- It may take up to one minute for the VCR to calculate and display the remaining tape length after you press DISPLAY.

# Locating a channel by Station ID

You can select the TV program from station ID.

## Before you start...

- Set FAVORITE CH to OFF in the ADVANCED OPTIONS menu (page35).

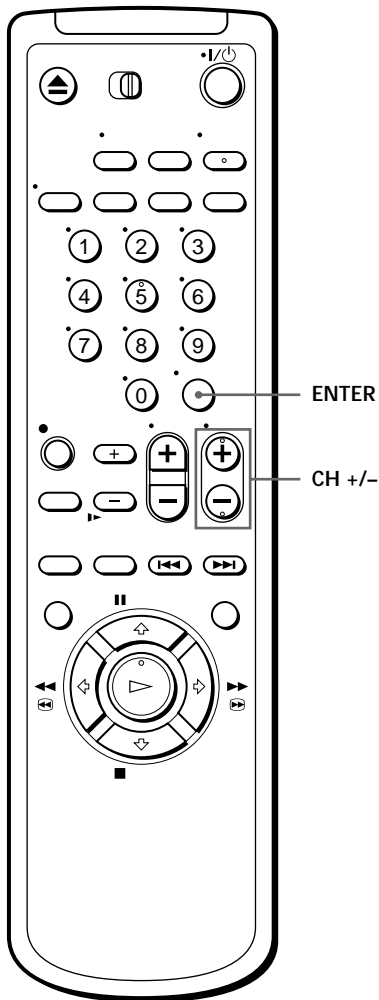

**1**

Turn on your TV and set it to the video channel.  
To record from a cable box, turn it on.

continued

---

## Locating a channel by Station ID (continued)

**2**    •ENTER    Press ENTER.  
The station ID appears on the TV screen.



3	AAB
9	CDE
10	FGH
12	IJK
13	LMN
15	OPQ
19	RST
22	UVW
43	XYZ
45	ABB

**3**    •CH    Press CH +/- to select the station ID  
you want.



**The selected station ID**

3	AAB
9	CDE
10	FGH
12	IJK
13	LMN
15	OPQ
19	RST
22	UVW
43	XYZ
45	ABB

**4**    •ENTER    Press ENTER.



### Note

- If the TV channel has no station ID, the channel number appears on the TV screen.

# Recording TV programs using the VCR Plus+ GOLD system

Just enter the PlusCode number listed in the TV program guide. The date, time and channel number of that program are set automatically. You can preset up to eight programs at a time.

## Before you start...

- Check that the VCR clock is set to the correct time.
- Turn on your TV and set it to the video channel. When using a cable box, turn it on.
- Insert a tape with its safety tab in place. Make sure the tape is longer than the total recording time.
- If you insert a tape with the SmartFile function, make sure the total recording time doesn't overlap the protected program. For details about the SmartFile function, see page 39.

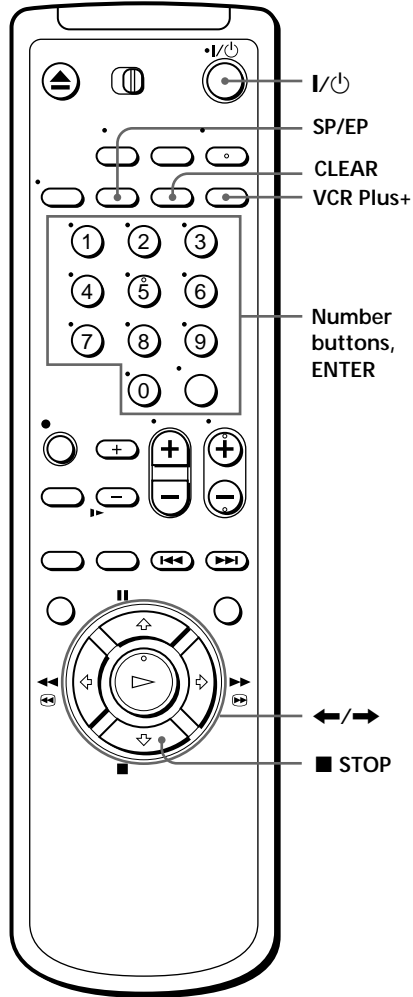

**1** VCR Plus+  Press VCR Plus+.

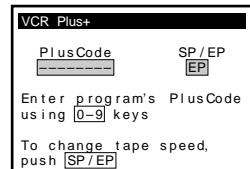

continued

## Recording TV programs using the VCR Plus+ GOLD system (continued)

2

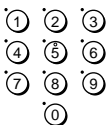

Press the number buttons to enter the PlusCode number.



If you make a mistake, press CLEAR and re-enter the correct number.

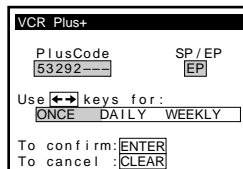

3



Press SP/EP to select the tape speed, SP or EP.

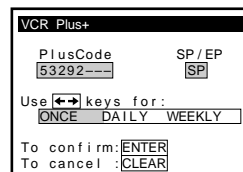

4



Press  $\leftarrow/\rightarrow$  to select ONCE, DAILY, or WEEKLY, then press ENTER:



To record	Select
Only once	ONCE
Everyday Monday to Friday	DAILY
Once a week	WEEKLY



The date, start and stop time, channel number and tape speed appear on the TV screen. If the information is not correct, press CLEAR to cancel the setting.

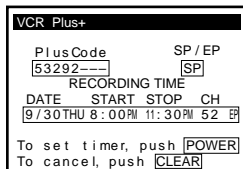

5

To enter another setting, repeat steps 1 to 4.

6



Press I/⏻ to turn off the VCR.

The  $\ominus$  indicator appears in the display window and the VCR stands by for recording. When using a cable box, leave it on.

### To stop recording

To stop the VCR while recording, press ■ STOP.

## To use the VCR after setting the timer

To use the VCR before a timer recording begins, just press **I/⏻**. The **⏻** indicator disappears from the display window and the VCR switches on. Remember to press **I/⏻** to reset the VCR to the timer recording standby mode after using the VCR.

You can also do the following tasks while the VCR is recording:

- Reset the counter.
- Display tape information on the TV screen.
- Check the timer settings.
- Watch another TV program.

## To lock the VCR after setting the timer (Child Lock)

While the VCR turns on, hold down **I/⏻ POWER on the VCR** until the **⏻** indicator appears in the display window. The VCR turns off and the **⏻** indicator remains lit. The VCR will not work except for timer recording.

To unlock the VCR, hold down **I/⏻ POWER on the VCR** until the **⏻** indicator disappears from the display window. The VCR is unlocked and turns on.

To stop timer recording while the VCR is locked, press **■ STOP**. The recording stops and the VCR is unlocked.

## Tips

- To cancel the VCR Plus+ GOLD system recording, press VCR Plus+ before pressing ENTER in step 4 above.
- When you are recording a program in the SP mode and the remaining tape becomes shorter than the recording time, the tape speed is automatically changed to the EP mode. Note that some noises will appear on the picture when the tape speed is changed. If you want to keep the tape speed, set AUTO TAPE SPEED to OFF in the ADVANCED OPTIONS menu (page 35).
- When a tape with a SmartFile label attached is inserted, the AUTO BLANK SEARCH screen appears after step 5. Wait about ten seconds for the screen to appear before pressing the **I/⏻** button in step 6. For details, see "Setting timer recording in the Blank Time space" (page 47).

## Notes

- If the VCR does not accept the PlusCode number, this means that:
  - The PlusCode number is incorrect.
  - ONCE, DAILY, or WEEKLY was selected incorrectly. You cannot select DAILY or WEEKLY for a program that airs more than seven days ahead.
- The VCR will be unlocked when:
  - you stop timer recording by pressing **■ STOP**
  - you insert a tape
  - the AC power cord is disconnected or power supply stops.

# Setting the timer manually

If the VCR Plus+ GOLD system is not available in your area, follow the instructions below to set the timer to record programs.

## Before you start...

- Check that the VCR clock is set to the correct time.
- Turn on your TV and set it to the video channel. When using a cable box, turn it on.
- Insert a tape with its safety tab in place. Make sure the tape is longer than the total recording time.
- If you insert a tape with the SmartFile function, make sure the total recording time doesn't overlap the protected program. For details about the SmartFile function, see page 39.

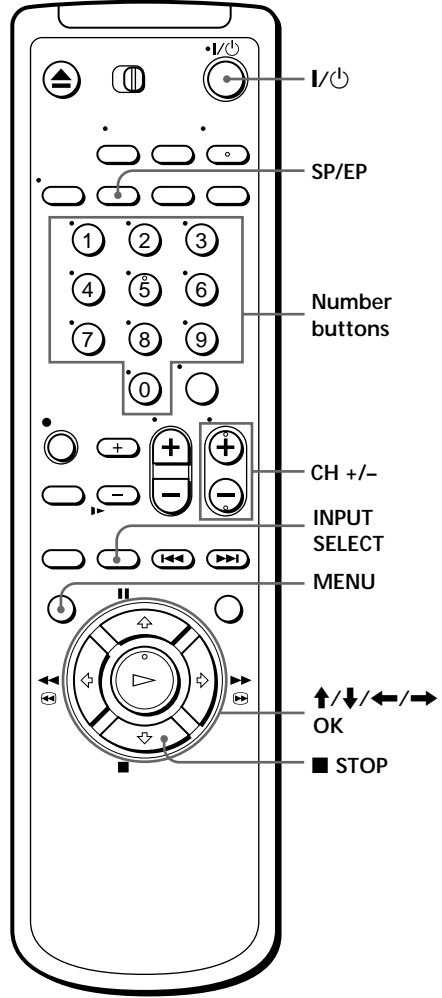

1

MENU



Press MENU, then press **↑/↓** to select **TIMER SET / CHECK** and press OK.



TIMER SET / CHECK				9 / 28 THU
DATE	START	STOP	CH	
- / - / -	- : -	- : -	-	-
- / - / -	- : -	- : -	-	-
- / - / -	- : -	- : -	-	-
- / - / -	- : -	- : -	-	-
- / - / -	- : -	- : -	-	-
- / - / -	- : -	- : -	-	-



2



Press **↑/↓** to select the line that is to be set.

3



Set the date, start and stop time, channel number and tape speed:

1 Press **→** to highlight each item in turn.

2 Press **↑/↓** to set each item.

To correct a setting, press **←** to return to that setting and reset.

TIMER SET / CHECK				9 / 28 THU
DATE	START	STOP	CH	
9 / 30 THU	---	---	---	[SP]
- / - -	- : - -	- : - -	- - - -	- -
- / - -	- : - -	- : - -	- - - -	- -
- / - -	- : - -	- : - -	- - - -	- -
- / - -	- : - -	- : - -	- - - -	- -
- / - -	- : - -	- : - -	- - - -	- -
- / - -	- : - -	- : - -	- - - -	- -

When you set the channel number, the station ID appears on the TV screen. You can set it while checking the station ID.

To record the same program every day or the same day every week, press **↓** while the date is highlighting. For details, see "Daily / weekly recording" below.

TIMER SET / CHECK				9 / 28 THU
DATE	START	STOP	CH	STATION ID
9 / 30 THU	7:00 AM	8:00 AM	[T2]	[SP]
- / - -	- : - -	- : - -	- - - -	- -
- / - -	- : - -	- : - -	- - - -	- -
- / - -	- : - -	- : - -	- - - -	- -
- / - -	- : - -	- : - -	- - - -	- -
- / - -	- : - -	- : - -	- - - -	- -
- / - -	- : - -	- : - -	- - - -	- -
- / - -	- : - -	- : - -	- - - -	- -

INPUT SELECT



To record from a source connected to the LINE-1 IN or LINE-2 IN jacks, press INPUT SELECT to display "LINE1" or "LINE2" in the "CH" position.

4



Press **→** to confirm the setting.

The cursor appears at the beginning of the line. To enter another setting, select the next line and repeat step 3.

5



Press OK.

6

• I / ⏻



Press **I / ⏻** to turn off the VCR.

The **⏻** indicator appears in the display window and the VCR stands by for recording. When using a cable box, leave it on.

continued

## Setting the timer manually (continued)

### To stop recording

To stop the VCR while recording, press ■ STOP.

### Daily/weekly recording

In step 3 above, press ↓ to select the recording pattern. Each time you press ↓, the indication changes as shown below. Press ↑ to change the indication in reverse order.

the current date → SUN-SAT → MON-SAT → MON-FRI → EVERY SAT → .....  
→ EVERY MON → EVERY SUN → 1 month later → (date counts down) →  
the current date

### To use the VCR after setting the timer

To use the VCR before a timer recording begins, just press I/⏻. The ⏻ indicator disappears from the display window and the VCR switches on. Remember to press I/⏻ to reset the VCR to the timer recording standby mode after using the VCR.

You can also do the following tasks while the VCR is recording:

- Reset the counter.
- Display tape information on the TV screen.
- Check the timer settings.
- Watch another TV program.

### To lock the VCR after setting the timer (Child Lock)

While the VCR turns on, hold down I/⏻ POWER on the VCR until the ⏻ indicator appears in the display window. The VCR turns off and the ⏻ indicator remains lit. The VCR will not work except for timer recording.

To unlock the VCR, hold down I/⏻ POWER on the VCR until the ⏻ indicator disappears from the display window. The VCR is unlocked and turns on.

To stop timer recording while the VCR is locked, press ■ STOP. The recording stops and the VCR is unlocked.

### Tips

- To set the channel, you can also use the CH +/- or number buttons.
- To set the tape speed, you can also use the SP/EP button.
- When you are recording a program in the SP mode and the remaining tape becomes shorter than the recording time, the tape speed is automatically changed to the EP mode. Note that some noises will appear on the picture when the tape speed is changed. If you want to keep the tape speed, set AUTO TAPE SPEED to OFF in the ADVANCED OPTIONS menu (page 35).
- When a tape with a SmartFile label attached is inserted, the AUTO BLANK SEARCH screen appears after closing the menu in step 5. For details, see "Setting timer recording in the Blank Time space" (page 47).

### Notes

- If you are using cable box control, you cannot select "LINE1" or "LINE2".
- The station ID appears on the TV screen only when you complete Smart Channel Mapping and the VCR receives the program information signal (see page 54 of the supplied hookup/setup manual).

# Playing/searching at various speeds

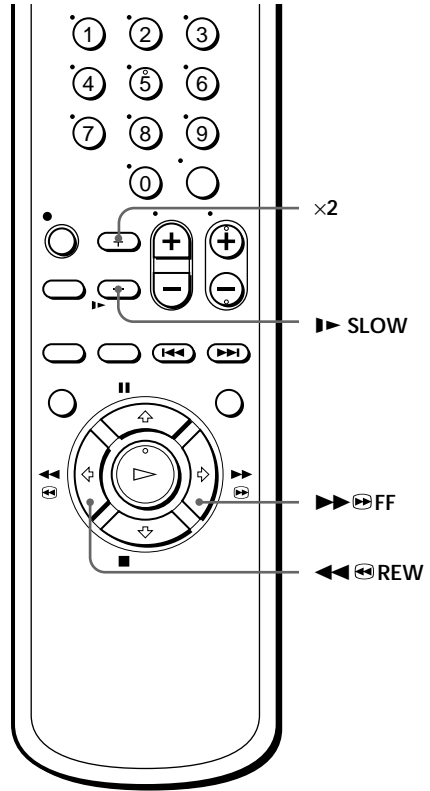
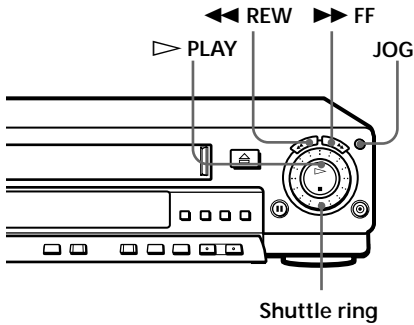

Playback options	Operation
View the picture during fast-forward or rewind	During fast-forward, hold down <b>▶▶▶▶FF/▶▶ FF</b> . During rewind, hold down <b>◀◀◀◀REW/◀◀ REW</b> .
Play at high speed	<ul style="list-style-type: none"> <li>• During playback, press <b>▶▶▶▶FF</b> or <b>◀◀◀◀REW</b> on the remote commander.</li> <li>• During playback, hold down <b>▶▶▶▶FF/▶▶ FF</b> or <b>◀◀◀◀REW/◀◀ REW</b>. When you release the button, normal playback resumes.</li> </ul>
Play at twice the normal speed	During playback, press <b>x2</b> .
Play in slow motion	During playback or pause, press <b>▶▶ SLOW</b> .

Playback options	Operation
Play frame by frame	During pause, press <b>▶▶FF</b> or <b>◀◀REW</b> <u>on the remote commander</u> . Hold down the button to play one frame each second.
Rewind and start play	During stop, press <b>▷PLAY</b> <u>on the VCR</u> while holding down <b>◀◀REW</b> <u>on the VCR</u> .

### To resume normal playback

Press **▷PLAY**.

## Using the shuttle ring

With the shuttle ring, you can operate a variety of playback options. There are two ways for using the shuttle ring, normal mode and jog mode.

### To use the shuttle ring in normal mode

During playback or pause, turn the shuttle ring clockwise or counterclockwise. Each change in the shuttle ring position changes the playback mode, and the corresponding mark appears on the TV screen for a few seconds in the following way if the on-screen display function is on:

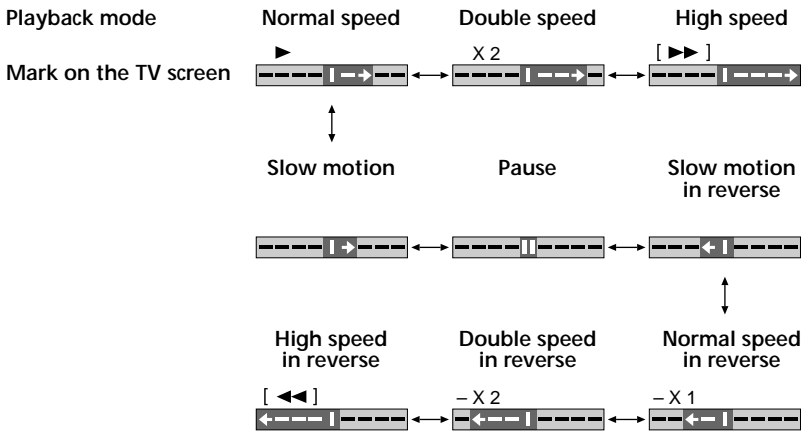

continued

---

## ***Playing/searching at various speeds (continued)***

### **To use the shuttle ring in jog mode**

Use this mode for frame-by-frame playback.

Press JOG to enter the jog mode. The JOG button lights up. If you change to the jog mode during any playback mode, the playback pauses so you can see a still picture. Each change in the shuttle ring position shifts the picture one frame. To shift frames in reverse, turn the shuttle ring counterclockwise. The frame shift speed depends on the speed you turn the shuttle ring. To resume normal mode, press JOG again. The JOG button goes off.

### **Tip**

- Adjust the picture using the TRACKING +/- buttons if:
  - Streaks appear while playing in slow motion.
  - The picture shakes while pausing.
- To set tracking to the center position, press both buttons (+/-) at the same time.

### **Notes**

- The sound is muted during these operations.
- Tapes recorded in the LP mode on other VCRs can be played back on this VCR but the picture quality cannot be guaranteed.
- The picture may have snow:
  - when playing at high speed in reverse
  - when playing in reverse slow motion
  - when playing in reverse
- If the playback mode mark doesn't appear on the TV screen, press DISPLAY.
- The picture may flutter a bit when playing in slow motion.

# Creating a favorite channel list with Station ID

You can create your favorite channel list of the TV channels with station ID. You can store up to 10 channels with station ID and select the channel from your favorite channel list.

## Before you start...

- Set FAVORITE CH to ON in the ADVANCED OPTIONS menu (page35).

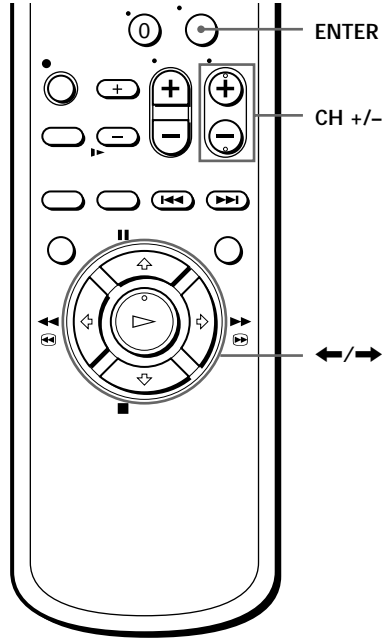

## Creating your favorite channel list

- 1 Press ENTER.  
The FAVORITE CH screen appears on the TV screen.
- 2 Press CH +/- to select the station ID you want to replace.

The selected station ID

FAVORITE CH		Station ID
12	IJK	
15	OPQ	
9	CDE	
13	LMN	
19	RST	
3	AAB	
45	ABB	
43	XYZ	
22	UVW	
10	FGH	

continued

## Creating a favorite channel list with Station ID (continued)

- 3** Press **←/→** to select the station ID you want to set.

FAVORITE CH		
12		UJK
15		OPO
27		BBA
13		LMN
19		RST
3		AAB
45		ABB
43		XYZ
22		UVW
10		FGH

- 4** Repeat steps 2 and 3 to set the station IDs as required.
- 5** Press ENTER.

### Note

- If the TV channel has no station ID, the channel number appears on the TV screen.



# Selecting a channel from your favorite channel list

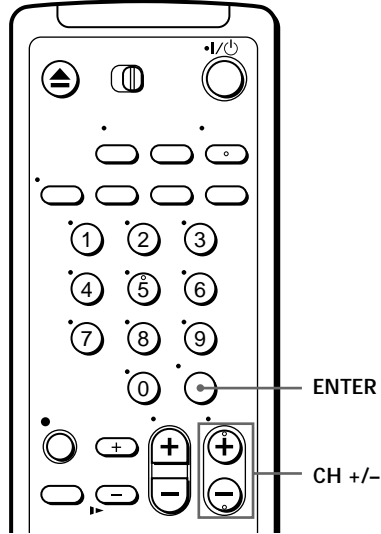

- 1 Turn on your TV and set it to the video channel.  
To choose a channel from a cable box, turn the cable box on.
- 2 Press ENTER.  
Your FAVORITE CH screen appears on the TV screen.

FAVORITE CH		
12	IJK	
15	OPQ	
27	BBA	
13	LMN	
19	RST	
3	AAB	
45	ABB	
43	XYZ	
22	UVW	
10	FGH	

- 3 Press CH +/- to select the station ID you want.

The selected station ID

FAVORITE CH		
12	IJK	
15	OPQ	
27	BBA	
13	LMN	
19	RST	
3	AAB	
45	ABB	
43	XYZ	
22	UVW	
10	FGH	

- 4 Press ENTER.

**Note**

- If the TV channel has no station ID, the channel number appears on the TV screen.

# Setting the recording duration time

After starting recording in the normal way, you can have the VCR stop recording automatically after a specified duration.

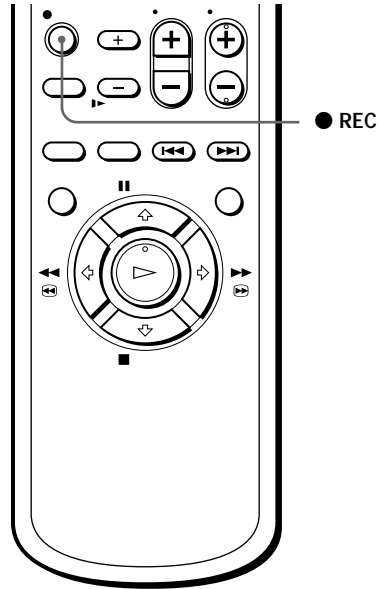

- 1 While recording, press ● REC.  
The ⏻ indicator appears in the display window.

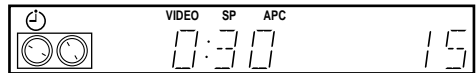

- 2 Press ● REC repeatedly to set the duration.  
Each press advances the time in increments of 30 minutes.

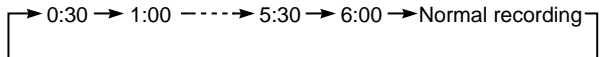

The tape counter decreases minute by minute to 0:00, then the VCR stops recording and turns off automatically.

## To extend the duration

Press ● REC repeatedly to set a new duration.

## To cancel the duration

Press ● REC repeatedly until the ⏻ indicator disappears and the VCR returns to normal recording mode.

## To stop while recording

Press ■ STOP.

## Note

- You cannot display the current tape time in the display window when setting the recording duration.

# Checking/ changing/ canceling timer settings

Before you start...

- Turn on your TV and set it to the video channel.

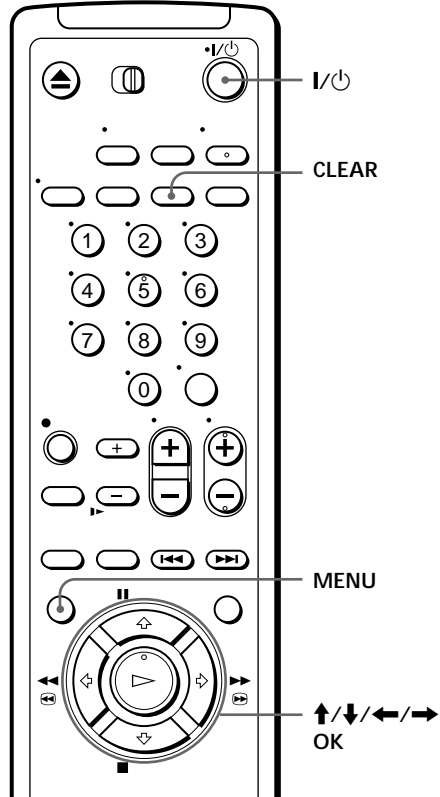

- 1 Press I/Power to turn on the VCR.
- 2 Press MENU, then press ↑/↓ to select TIMER SET/CHECK and press OK.
  - If you want to change a setting, go on to the next step.
  - If you do not need to change the settings, press OK, then turn off the VCR to return to recording standby.

TIMER SET / CHECK				9 / 28 TUE
DATE	START	STOP	CH	
9 / 30 THU	7 : 00 AM	8 : 00 AM	6 SP	
10 / 2	10 : 30 PM	11 : 15 PM	60 EP	
MON - SAT	1 : 00 AM	3 : 00 AM	LINE1 EP	
EVERY SUN	12 : 55 PM	1 : 30 PM	12 SP	
- / - -	- : - -	- : - -	- - - -	
- / - -	- : - -	- : - -	- - - -	
- / - -	- : - -	- : - -	- - - -	
- / - -	- : - -	- : - -	- - - -	

continued

---

## Checking/changing/canceling timer settings (continued)

- 3** Press **↑/↓** to select the setting you want to change or cancel:
- To change the setting, press **←/→** to highlight the item you want to change, and press **↑/↓** to reset it. Then, press **→** repeatedly until the cursor appears at the beginning of the line.
  - To cancel the setting, press CLEAR.
- 4** Press OK.
- If any timer settings remain, turn off the VCR to return to recording standby.

### When the timer settings overlap

The program that starts first has priority and the second program starts recording only after the first program has finished. If the programs start at the same time, the program listed first in the menu has priority.

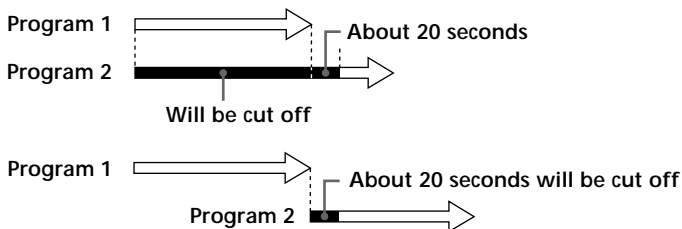

---

# Recording stereo and bilingual programs

## Recording stereo programs

This VCR automatically receives and records stereo programs. When a stereo program is received, the STEREO indicator lights up. If there is noise in the stereo program, set AUTO STEREO in the ADVANCED OPTIONS menu to OFF. The sound will be recorded in monaural (on both hi-fi and normal audio tracks) but with less noise. For details, see page 34.

## Recording bilingual programs

Normally, this VCR records only the main sound. When a SAP (Second Audio Program) is received, the SAP indicator lights up. To record only SAP sound, set TUNER AUDIO in the ADVANCED OPTIONS menu to SAP. For details, see page 35.

## Selecting the sound during playback

Press AUDIO MONITOR to select the sound you want. (The sound being recorded will not change.)

To listen to	On-screen display	Display window
Stereo	STEREO	STEREO
Left channel	LEFT CH	STEREO
Right channel	RIGHT CH	STEREO
Monaural sound on the normal audio track	No indicator	No indicator

**continued**

---

---

## Recording stereo and bilingual programs (continued)

### How sound is recorded on a video tape

The VCR records sound onto two separate tracks. Hi-fi audio is recorded onto the main track along with the picture. Monaural sound is recorded onto the normal audio track along the edge of the tape.

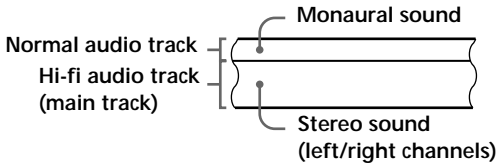

#### Notes

- To play a tape in stereo, you must use the A/V connections.
- When you play a tape recorded in monaural, the sound is heard in monaural regardless of the AUDIO MONITOR setting.
- If the AUDIO MONITOR button does not function, check that AUDIO MIX in the ADVANCED OPTIONS menu is set to OFF.

# Searching using the index function

The VCR marks the tape with an index signal at the point where each recording begins. Use these signals as references to find a specific recording. The VCR can search up to 99 index signals ahead of or behind the current position.

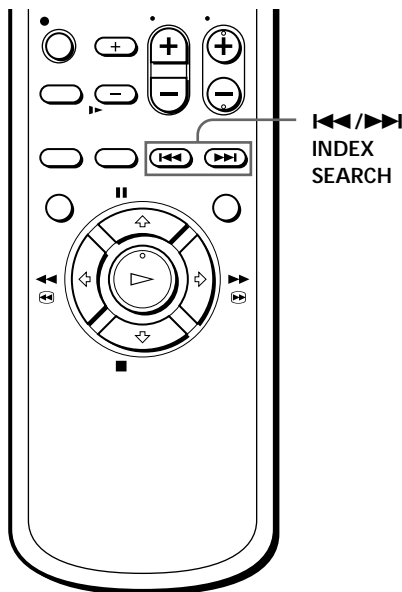

- 1 Insert an indexed tape into the VCR.
- 2 Press **◀◀/▶▶** INDEX SEARCH repeatedly to specify how many index signals ahead or behind you want to search:
  - To search ahead, press **▶▶** INDEX SEARCH.
  - To search backwards, press **◀◀** INDEX SEARCH.

The VCR starts searching and the index number on the TV screen counts down to zero. Playback starts automatically from that point.

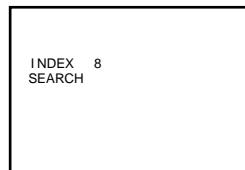

## To stop searching

Press **■** STOP.

## Note

- No index signal will be added when recording starts from recording pause. However, an index signal will be marked if you change the program position during recording pause.

# Adjusting the picture

## Adjusting the tracking

Although the VCR automatically adjusts the tracking when playing a tape (the  indicator flashes in the display window, then goes off), distortion may occur if the tape was recorded in poor condition. In this case, manually adjust the tracking.

Press the TRACKING +/- buttons to display the tracking meter. The distortion should disappear as you press one of the two buttons (the  indicator lights up). To resume automatic tracking adjustment, eject the tape and reinsert it.

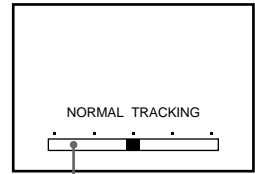

Tracking meter

## About the Reality Regenerator function

The Reality Regenerator function automatically restores the picture to its original quality during playback.

To use the Reality Regenerator function, press REALITY REGENERATOR. The REALITY REGENERATOR indicator lights up.

To turn it off, press REALITY REGENERATOR. The REALITY REGENERATOR indicator goes off.

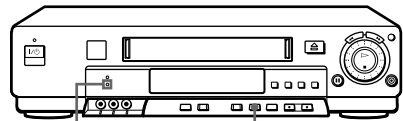

REALITY REGENERATOR

REALITY REGENERATOR indicator



---

## About the Adaptive Picture Control (APC) function

The Adaptive Picture Control (APC) function automatically improves recording and playback quality by adjusting the VCR to the condition of the video heads and tape. To maintain better picture quality, we recommend that you set APC to ON in the ADVANCED OPTIONS menu (with the APC indicator in the display window lit). For details, see page 35.

### APC playback

The APC function automatically works on all types of tapes, including rental tapes and tapes that were not recorded with APC.

### APC recording

Whenever you insert a tape and first start recording, the VCR adjusts to the tape using the APC function (the APC indicator flashes rapidly). This adjustment is retained until the tape is ejected.

### Notes

- The automatic tracking adjustment cannot be guaranteed to work with tapes recorded in the LP mode on other VCRs.
- The APC function does not work if the tape speed is automatically changed from the SP to EP mode during a timer recording when AUTO TAPE SPEED is set to ON in the ADVANCED OPTIONS menu, unless the tape has been recorded in the EP mode with the APC function.
- There is a delay of about ten seconds before the VCR actually starts recording while the VCR analyzes the tape. To avoid the delay, first set the VCR to recording pause (the APC indicator flashes slowly) and press ● REC to have the VCR analyze the tape (the APC indicator flashes rapidly). After the APC indicator stops flashing, press ■ PAUSE to start recording immediately.  
If you want to start recording quickly without using the APC function, first set the VCR to recording pause (the APC indicator flashes slowly) and press ■ PAUSE to start recording.

# Changing menu options

- 1 Press MENU, then press  $\uparrow/\downarrow$  to select **ADVANCED OPTIONS** and press OK.
- 2 Press  $\uparrow/\downarrow$  to select the option to change, then press  $\leftarrow/\rightarrow$  to change the setting.  
The **ADVANCED OPTIONS** menu has 3 pages. Pressing  $\uparrow/\downarrow$  repeatedly will turn the pages.
- 3 Press OK to return to the original screen.

## Page 1

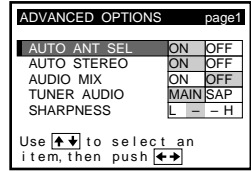

## Page 2

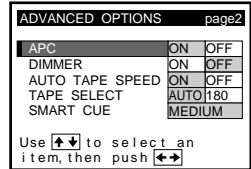

## Page 3

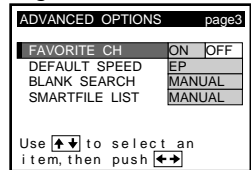

## Menu choices

Initial settings are indicated in bold print.

Menu option	Set this option to
AUTO ANT SEL	<ul style="list-style-type: none"> <li>• <b>ON</b> if your TV is connected only to VHF/UHF OUT on the VCR. To play a tape, set the TV to the VCR channel (channel 3 or 4).</li> <li>• <b>OFF</b> if your TV is connected to both VHF/UHF OUT and LINE OUT on the VCR. To play a tape, set the TV to the VCR input.</li> </ul>
AUTO STEREO	<ul style="list-style-type: none"> <li>• <b>ON</b> to receive stereo programs.</li> <li>• <b>OFF</b> to reduce noise. The sound changes to monaural.</li> </ul>
AUDIO MIX	<ul style="list-style-type: none"> <li>• <b>ON</b> to listen to the sound recorded on hi-fi and normal audio tracks at the same time. The AUDIO MONITOR button will not function.</li> <li>• <b>OFF</b> to listen to hi-fi and normal audio tracks separately. Select the sound using the AUDIO MONITOR button.</li> </ul>

Menu option	Set this option to
TUNER AUDIO	<ul style="list-style-type: none"> <li>• <b>MAIN</b> to record the main sound on both hi-fi and normal audio tracks.</li> <li>• <b>SAP</b> to record the SAP (Second Audio Program) sound on both hi-fi and normal audio tracks.</li> </ul>
SHARPNESS	L (Low) through H (High) to adjust the sharpness of the picture. L to turn off the sharpness control.
APC	<ul style="list-style-type: none"> <li>• <b>ON</b> to switch on the APC (Adaptive Picture Control) function and improve picture quality.</li> <li>• <b>OFF</b> to switch off APC.</li> </ul>
DIMMER	<ul style="list-style-type: none"> <li>• <b>ON</b> to make the display window dim.</li> <li>• <b>OFF</b> to make it brighter.</li> </ul>
AUTO TAPE SPEED	<ul style="list-style-type: none"> <li>• <b>ON</b> to change the timer recording tape speed automatically to the EP mode when the remaining tape length becomes shorter than the recording time. To operate AUTO TAPE SPEED, set TAPE SELECT correctly.</li> <li>• <b>OFF</b> to keep the tape speed.</li> </ul>
TAPE SELECT	<ul style="list-style-type: none"> <li>• <b>AUTO</b> when using a T-160 length tape or any tape shorter than a T-140 length tape.</li> <li>• <b>180</b> when using a T-140 or T-180 length tape.</li> </ul> <p>For details, see page 9.</p>
SMART CUE	<ul style="list-style-type: none"> <li>• <b>MEDIUM</b> to set the automatic rewinding time on skip playback to a medium length.</li> <li>• <b>SHORT</b> to set to a short length.</li> <li>• <b>LONG</b> to set to a long length.</li> </ul>
FAVORITE CH	<ul style="list-style-type: none"> <li>• <b>ON</b> when using favorite channel list.</li> <li>• <b>OFF</b> when using station ID list.</li> </ul> <p>For details, see pages 11 and 23.</p>
DEFAULT SPEED	<ul style="list-style-type: none"> <li>• <b>EP</b> to set the recording tape speed automatically back to EP after recording.</li> <li>• <b>SP</b> to set the recording tape speed automatically back to SP after recording.</li> <li>• <b>FLOAT</b> to set the recording tape speed to the last position selected from the SP/EP button.</li> </ul>

**continued**

---

## Changing menu options (continued)

Menu option	Set this option to
BLANK SEARCH	<ul style="list-style-type: none"><li>• <b>MANUAL</b> to display a screen asking whether to search for the Blank Time when the timer is set.</li><li>• <b>AUTO</b> to set the VCR to perform the Blank Time search automatically each time the timer is set.</li><li>• <b>OFF</b> to switch off the Blank Time search function.</li></ul> For details, see page 47.
SMARTFILE LIST	<ul style="list-style-type: none"><li>• <b>MANUAL</b> to display the SmartFile search list only when you press the SMARTFILE button.</li><li>• <b>AUTO</b> to display the SmartFile search list automatically when you insert a SmartFile tape.</li></ul>

### Note

- If you set the DEFAULT SPEED option to EP, you can still change the recording tape speed to SP, or vice versa by pressing the SP/EP button only for that program. Next time you record a program, the recording tape speed is automatically set to the position you set in the DEFAULT SPEED option.

# Editing with another VCR

## How to hook up to record on this VCR

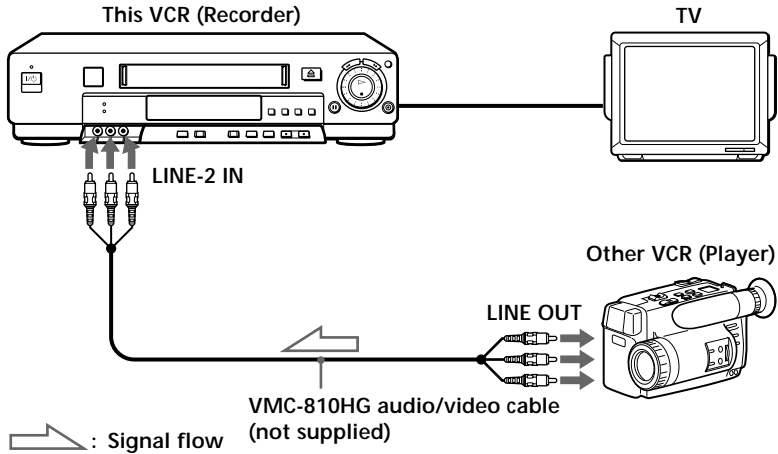

## How to hook up to a stereo system

Connect LINE-2 IN AUDIO on this VCR to the audio output jacks on the stereo system, using the RK-C510KS audio cable (not supplied).

## If the other VCR has a CONTROL S OUT jack for synchronized editing

Hook up to record on the other VCR, then connect the VCRs via the CONTROL S jacks. The CONTROL S connection lets you control (pause and release pause) both VCRs from the recording VCR.

### Notes

- Make sure you connect the plugs to jacks of the same color.
- If the other VCR is a monaural type and connected to this VCR's LINE-2 IN jacks, connect the audio plug to the AUDIO L (white) jack. The sound is recorded on both right and left channels. When connecting to the AUDIO R (red) jack, the sound is recorded only on the right channel.
- If you connected this VCR to both the LINE IN and LINE OUT jacks of the other VCR, select the input correctly to prevent a humming noise.
- You can also use the LINE-1 IN jacks for editing. If the other VCR is a monaural type, the sound is recorded only on the channel whose jack is connected to the audio plug. To record on both right and left channels, connect the audio plugs to the AUDIO R/L jacks using a VMC-910HG audio/video cable (not supplied).
- If the CONTROL S IN jack is used for S-Link™ (A/V bus control) with a TV, the CONTROL S connection cannot be used for editing.

continued

---

## Editing with another VCR (continued)

### Operation (when recording on this VCR)

#### Before you start editing

- Turn on your TV and set it to the video channel.
- Press INPUT SELECT to display “L2” (or “L1”) in the display window.
- Press SP/EP to select the tape speed, SP or EP.
- On this VCR, press EDIT to display “EDIT” in the display window. If the other VCR has a similar button, press it to activate edit function.

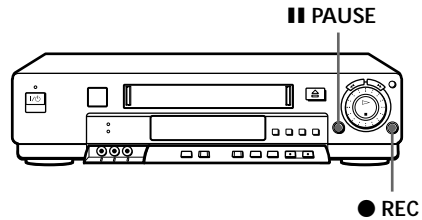

- 1 Insert a source tape with its safety tab removed into the other (playback) VCR. Search for the point to start playback and set it to playback pause.
- 2 Insert a tape into this (recording) VCR. Search for the point to start recording and press **|| PAUSE**.
- 3 Press **● REC** on this VCR and set it to recording pause.
- 4 To start editing, press the **|| PAUSE** buttons on both VCRs at the same time.

#### To stop editing

Press the **■ STOP** buttons on both VCRs.

#### Tip

- To cut out unwanted scenes while editing, press **|| PAUSE** on this VCR when an unwanted scene begins. When it ends, press **|| PAUSE** again to resume recording.

#### Note

- If you start recording following the procedure above, the VCR won't start recording with the APC function. To record a tape with the APC function, press **● REC** again during recording pause in step 3 so that the VCR analyzes the tape. Then when you start recording in step 4, press **|| PAUSE** immediately after the APC indicator stops flashing. If you press **|| PAUSE** before the APC indicator stops flashing, the APC function is canceled.

# About the SmartFile function

SmartFile\* allows you to view the contents of your video tape (recording date, channel, etc.) on the TV screen. It is no longer necessary to rewind, fast-forward, or play back a tape to find out what is recorded. You can also locate and start playback of a specific program, or find the position from which you want to start recording by using this list. Program data is stored in the memory of the SmartFile label attached to the tape.

The following functions are possible using SmartFile:

## Recording using the SmartFile function (page 41)

To use the SmartFile function, attach the SmartFile label to the tape. If you record a program on a tape with a SmartFile label, the contents will appear on the SmartFile search list. With the SmartFile list, you can also easily find the beginning of the available recording space.

SmartFile search list

8/10/99-8/16/99		p. 1	
BLANK TIME		EP 1H 48M	
MON	6:30 PM CH 16	8/16	
		0H 30M SP	
FRI	8:00 PM CH 12	8/13	
		0H 50M SP	
TUE	2:30 PM CH 8	8/10	
		0H 30M EP	
START		END	

## Selecting and playing a program (page 50)

To play back a recorded program, select the program you want to watch using the SmartFile search list. The VCR locates the program and playback starts automatically.

## Checking the contents of a tape (page 52)

When you bring the SmartFile label close to the SMARTFILE sensor on the VCR, a summary of the recorded programs appears in the SmartFile check list. It is not necessary to insert the tape into the VCR and press  $\triangleright$  PLAY to find out what is recorded on it. This feature allows you to easily find the program you want to watch, or to quickly find a tape with enough recording space.

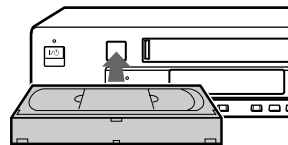

SmartFile check list

8/10/99-8/30/99		p. 1	
BLANK TIME		EP 1H 48M	
MON	9:00 PM CH 16	8/30	
SUN	6:30 PM CH 4	8/29	
FRI	8:00 PM CH 12	8/27	
FRI	5:45 PM CH 7	8/27	
THU	1:00 PM CH 12	8/26	
TUE	4:30 PM CH 8	8/24	
NEXT: $\blacktriangleleft$ $\blacktriangleright$		QUIT: $\square$	

\* SmartFile is a trademark of Sony Corporation.

---

## **About the SmartFile function (continued)**

### **Labeling a recorded program and tape (page 53)**

You can attach an electronic “label” to the video tape and its programs on the SmartFile list. Labeling the recorded programs enables you to find a program easily when you want to play it back. Also, once you label a program which you set to record regularly (i.e. everyday, same day of a week, etc.), the VCR recognizes the label and will automatically label all future recordings of the same program.

### **Protecting a recorded program (page 58)**

You can protect a recorded program from accidental over-recording or erasure.

### **Erasing the data of an unwanted program (page 60)**

By erasing a program from the SmartFile list, the VCR will record over the unwanted program.

### **Registering the contents of a recorded tape in the SmartFile label (page 62)**

You can register programs recorded on a tape in the memory of a new SmartFile label.

### **Storing program data from the DIRECTV digital satellite receiver (Program Data Download) (page 64)**

If you connect a DIRECTV digital satellite receiver equipped with the Program Data Download function, you can store the program and category name transmitted from the DIRECTV digital satellite receiver on a SmartFile tape. The DIRECTV digital satellite receiver equipped with the Program Data Download function will be available in the future.



---

# Recording using the SmartFile function

To use the SmartFile function, attach the SmartFile label to the spine of the cassette tape. If you record a program on a tape with a SmartFile label, program data, such as the date and channel, is automatically stored in the memory of the SmartFile label.

## Attaching the SmartFile label to the cassette tape

To use the SmartFile function, attach the supplied SmartFile label to the cassette tape. Remove any stains or dirt from the surface of the spine of the tape. Then, holding both edges of the SmartFile label so that it doesn't bend, attach it along the guide line to the spine of the cassette tape. This tape is henceforth referred to as a SmartFile tape.

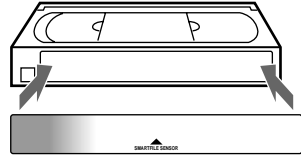

### Note on the purchase of SmartFile labels

- **For the customers in the USA**  
To order additional SmartFile labels, see the back page.
- **For the customers in Canada**  
Additional SmartFile labels can be purchased at Sony of Canada Ltd. Authorized VHS Dealers.

### Notes

- The SmartFile label is equipped with a memory chip. The memory chip may be damaged and cannot be used when you:
  - twist or fold the SmartFile label.
  - remove the SmartFile label and re-attach it to a tape.
  - attach more than one SmartFile label to a tape.
  - attach some metal, or sticker which has metal, to the SmartFile label.
  - write too strongly on the SmartFile label using a ballpoint pen or similar sharp instrument.
  - disassemble or remodel a label.
- Do not leave the SmartFile label in a place subject to excessive dust or dirt, direct sunlight, humidity, mildew, strong magnetism, or near heat sources.
- If you attach the SmartFile label to a short length tape, such as T-30 or shorter, you cannot use the SmartFile function.

continued

## Recording using the SmartFile function (continued)

### Recording a program on the SmartFile tape

When recording a program on the SmartFile tape, no matter what method you use to record the program (normal recording, the VCR Plus+ GOLD system recording, etc.), program data (date, channel, recording start time, etc.) is stored in the memory of the SmartFile label. The SmartFile label can contain up to 12 programs' data. When the number of the stored programs goes over 12, the oldest program data is erased from the SmartFile list. However, a program which lasts less than about 15 minutes in EP mode or about 5 minutes in SP mode cannot be stored in the memory. When you record a program on the SmartFile tape which already contains program data, see "Recording after locating the Blank Time space" on page 44.

#### Tip

- You can protect a recorded program from accidental over-recording or erasure (see page 58).

#### Note

- If you press **||** PAUSE one or more times during recording, thereby creating short lengths of recorded time between such pauses, program data may not be stored in the SmartFile label.

### To check the information of a recorded program

Press SMARTFILE. The SmartFile search list appears. The recording day of the week, start time, channel, date, station ID, recording time, and tape speed appear on the list. The longest space which doesn't have any program data (Blank Time space) appears as "BLANK TIME".

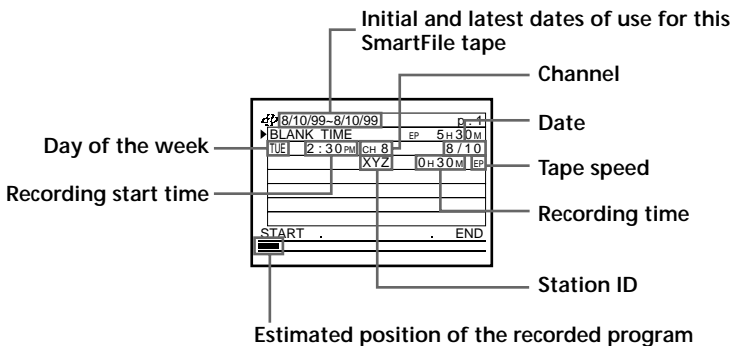

---

### Tips

- The station ID appears on the TV screen only when you complete Smart Channel Mapping and the VCR receives the program information signal (see page 54 of the supplied hookup/setup manual).
- When the VCR receives the program information signal, the program name may appear in place of the day of the week, recording start time and channel.
- You can manually name a recorded program and select the category. You can also name the SmartFile tape (see page 53).

### Notes

- If you don't set the clock or the clock isn't set to the correct time, the initial and latest dates of use for the SmartFile, the recording date and day of the week, and the recording start time won't be stored correctly on the SmartFile list.
- When you record a program using the normal recording mode while CABLE MOUSE is set to ON in the CABLE BOX CONTROL menu, the channel number is stored as "CH--".
- When you set AUTO TAPE SPEED to ON in the ADVANCED OPTIONS menu, and the tape speed automatically changes from SP to EP during recording, the VCR displays the entire recording time converted in SP mode to the SmartFile list.
- The recording time length in the SmartFile list is an estimation and may be slightly different from the actual recorded time length.

continued

---

## Recording using the SmartFile function (continued)

### Recording after locating the Blank Time space

The SmartFile function identifies not only the largest amount of available blank space, but also recorded material that doesn't have corresponding program data stored in the SmartFile label. The longest available recording space (including programs that are not stored on the SmartFile label) is referred to as "Blank Time space". You can locate the beginning of the Blank Time space for recording. If there is a recorded program after the Blank Time space, the VCR will record over that program unless you stop recording. If there is a program you want to prevent from being recorded over or erased, protect that program before you start recording another program (see page 58).

#### Before you start...

- Turn on your TV and set it to the video channel.

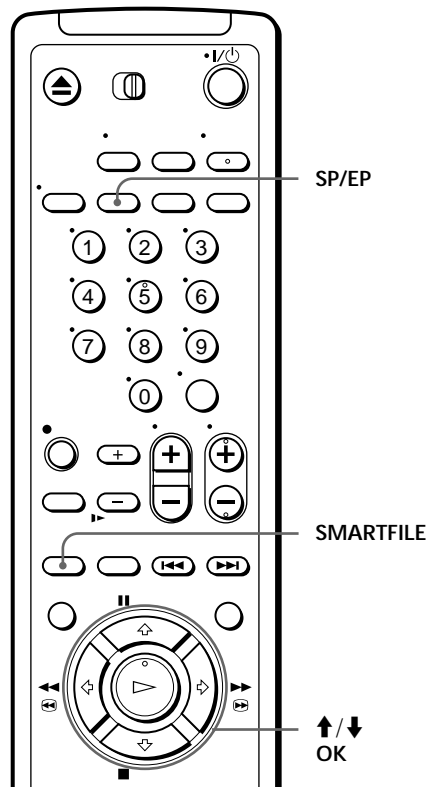

- 1 Insert a SmartFile tape with its safety tab in place.  
The VCR turns on and the SMARTFILE indicator lights up.
- 2 Press SMARTFILE.

The SmartFile search list appears on the TV screen. The Blank Time space appears in the "BLANK TIME" row.

The BLANK indicator lights up and the Blank Time space also appears in the display window.

8/10/99-8/16/99	p. 1
BLANK TIME	EP 1H48M
MON 6:30PM CH 16	8/16
	0H30M SP
FRI 8:00PM CH 12	8/13
	0H50M SP
TUE 2:30PM CH 8	8/10
	0H30M EP
START	END

**3** Press **↑/↓** to select BLANK TIME.

BLANK TIME is on page 1 of the SmartFile search list.

8/10/99-8/16/99		p. 1	
▶ BLANK TIME		EP	1H 48M
MON	6:30 PM CH 16	8/16	
		0H 30M	SP
FRI	8:00 PM CH 12	8/13	
		0H 50M	SP
TUE	2:30 PM CH 8	8/10	
		0H 30M	EP
START	.	.	END

**4** Press **SP/EP** to select the tape speed, SP or EP.

The BLANK TIME changes according to the selected tape speed. Select a tape speed that matches the length of the program you want to record.

8/10/99-8/16/99		p. 1	
▶ BLANK TIME		SP	0H 36M
MON	6:30 PM CH 16	8/16	
		0H 30M	SP
FRI	8:00 PM CH 12	8/13	
		0H 50M	SP
TUE	2:30 PM CH 8	8/10	
		0H 30M	EP
START	.	.	END

**5** Press **OK**.

The VCR goes to the beginning of the Blank Time space and stops.



**6** Start recording.

### If the recordings overlap

If a newly recorded program overlaps a stored program, the data appearing in the SMARTFILE list is as follows.

- If the second program overwrites the first program for 15 minutes or more in EP mode or 5 minutes or more in SP mode from where the first program starts, the first program data is erased.

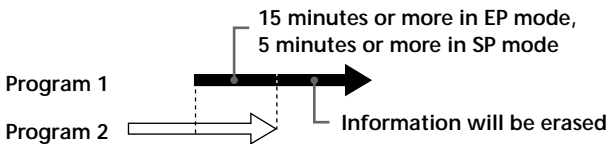

- If the remaining length of the first program is 15 minutes or less in EP mode or 5 minutes or less in SP mode after being overwritten by the second program, the first program data is erased.

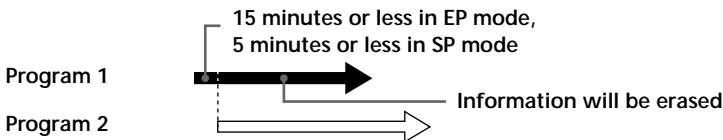

continued

## Recording using the SmartFile function (continued)

- If the second program starts recording 15 minutes or more in EP mode or 5 minutes or more in SP mode after the first program starts, the data for both programs appears. In this case, the stored program's recording time is updated to the time when the second program starts.

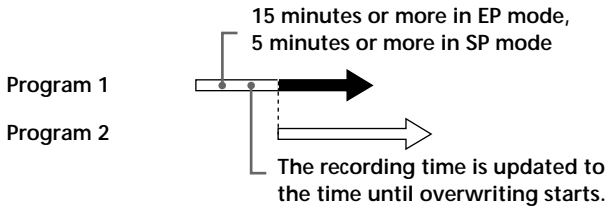

### Tip

- If you set SMARTFILE LIST to AUTO in the ADVANCED OPTIONS menu, the SmartFile search list appears automatically when you insert a SmartFile tape (see page 36).

### Note

- You may not be able to locate the beginning of the Blank Time space correctly in the above step 5 when:
  - the SmartFile tape contains one or more short length (less than about 15 minutes in EP mode and about 5 minutes in SP mode) programs that are not stored in the SmartFile label.
  - the SmartFile tape is damaged or dirty.

## Setting timer recording in the Blank Time space

If you set the timer to record programs while a SmartFile tape is inserted, the VCR searches for the Blank Time space. When the Blank Time space is located, the VCR goes to the beginning of the Blank Time space and stands by for recording. If there is a recorded program after the Blank Time space, the VCR will record over that program unless you stop recording. If there is a program you want to prevent from being recorded over or erased, protect that program before you start recording another program (see page 58).

### Before you start...

- Turn on your TV and set it to the video channel.

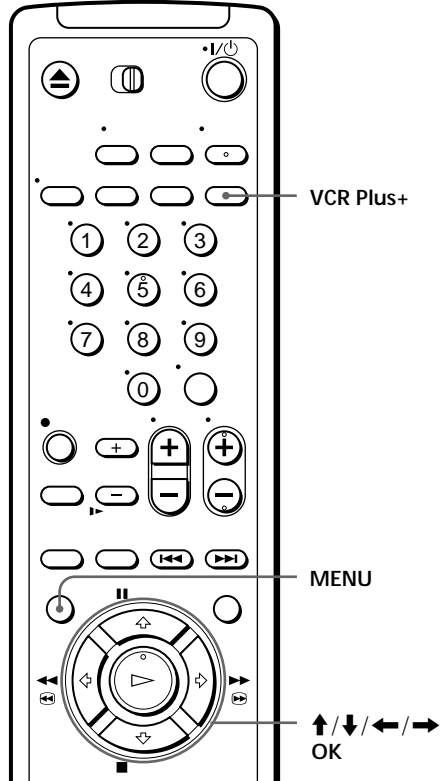

- 1 Insert a SmartFile tape with its safety tab in place.  
The VCR turns on and the SMARTFILE indicator lights up.
- 2 Set the timer.
  - When using the VCR Plus+ GOLD system (for details, see page 13):
    - 1 Press VCR Plus+.
    - 2 Enter the PlusCode number.

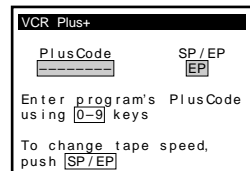

continued

## Recording using the SmartFile function (continued)

- When setting the timer manually (for details, see page 16):

- 1 Press MENU, then press  $\uparrow/\downarrow$  to select TIMER SET /CHECK and press OK.
- 2 Set the date, start and stop times, channel number and tape speed.
- 3 Press  $\rightarrow$  to confirm the setting and press OK.

TIMER SET /CHECK				9 / 28 TUE
DATE	START	STOP	CH	
- / - / -	- : -	- : -	-	-
- / - / -	- : -	- : -	-	-
- / - / -	- : -	- : -	-	-
- / - / -	- : -	- : -	-	-
- / - / -	- : -	- : -	-	-
- / - / -	- : -	- : -	-	-
- / - / -	- : -	- : -	-	-
- / - / -	- : -	- : -	-	-

The AUTO BLANK SEARCH screen appears.

AUTO BLANK SEARCH	
BLANK SEARCH?	
YES NO	
Use $\leftarrow/\rightarrow$ to select	
Then push OK	
Push MENU to quit	

- 3 Press  $\leftarrow/\rightarrow$  to select YES and press OK.

The Blank Time search screen appears.

The VCR goes to the beginning of the Blank Time space and stops, then turns off automatically.

The  $\ominus$  indicator appears in the display window and the VCR stands by for recording. If you are using a cable box, leave it on.

SEARCHING	
START	END

### If the recordings overlap

If a newly recorded program overlaps a stored program, the data appearing in the SMARTFILE list is as follows.

- If the second program overwrites the first program for 15 minutes or more in EP mode or 5 minutes or more in SP mode from where the first program starts, the first program data is erased.

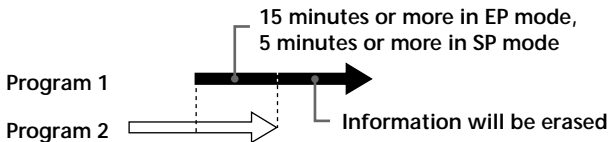



- If the remaining length of the first program is 15 minutes or less in EP mode or 5 minutes or less in SP mode after being overwritten by the second program, the first program data is erased.

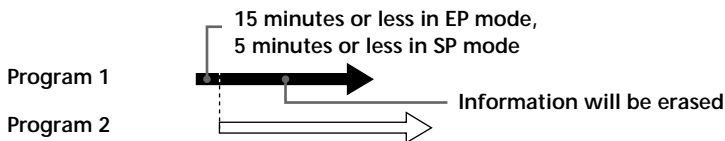

- If the second program starts recording 15 minutes or more in EP mode or 5 minutes or more in SP mode after the first program starts, the data for both programs appears. In this case, the stored program's recording time is updated to the time when the second program starts.

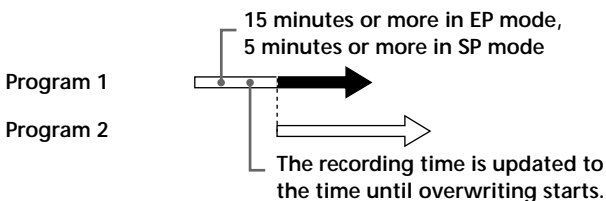

#### Tip

- You can set BLANK SEARCH in the ADVANCED OPTIONS menu so that Blank Time search is automatically performed each time the timer is set (AUTO). Select OFF to cancel this option (see page 36).

#### Note

- You may not be able to locate the beginning of the Blank Time space correctly in the above step 3 when:
  - the SmartFile tape contains one or more short length (less than about 15 minutes in EP mode and about 5 minutes in SP mode) programs that are not stored in the SmartFile label.
  - the SmartFile tape is damaged or dirty.

# Selecting and playing a program

You can automatically locate and start playback of a program recorded on the SmartFile tape. Select a program in the SmartFile search list. The SmartFile search list can contain up to 12 programs.

## Before you start...

- Turn on your TV and set it to the video channel.

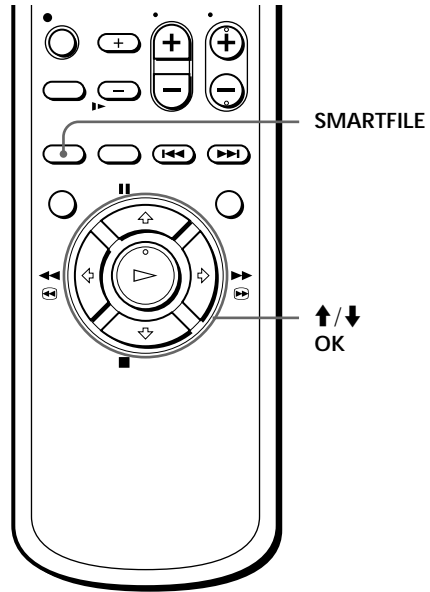

- 1 Insert a SmartFile tape.  
The VCR turns on and the SMARTFILE indicator lights up.

- 2 Press SMARTFILE.  
The SmartFile search list appears on the TV screen.  
The BLANK indicator lights up and the Blank Time space also appears in the display window.

8/10/99-8/16/99	p. 1
▶ BLANK TIME	EP 1H48M
MON 6:30PM CH 16	8/16
	0H30M SP
FRI 8:00PM CH 12	8/13
	0H50M SP
TUE 2:30PM CH 8	8/10
	0H30M EP
START . . .	END

- 3 Press **↑/↓** to select a program.  
Pressing **↑/↓** repeatedly will turn the pages.

8/10/99-8/16/99	p. 1
▶ BLANK TIME	EP 1H48M
MON 6:30PM CH 16	8/16
	0H30M SP
▶ FRI 8:00PM CH 12	8/13
	0H50M SP
TUE 2:30PM CH 8	8/10
	0H30M EP
START . . .	END

- 4 Press OK.  
The VCR starts searching for the beginning of the selected program. Playback starts automatically from that point.

## To stop searching

Press **■** STOP.

---

**Tip**

- If you set SMARTFILE LIST to AUTO in the ADVANCED OPTIONS menu, the SmartFile search list appears automatically when you insert a SmartFile tape (see page 36).

**Note**

- You may not be able to locate the beginning of the selected program correctly when:
  - the SmartFile tape contains one or more short length (less than about 15 minutes in EP mode and about 5 minutes in SP mode) programs that are not stored in the SmartFile label.
  - the SmartFile tape is damaged or dirty.

# Checking the contents of a tape

You can display the program data list of a SmartFile tape on the TV screen. It is not necessary to insert the tape into the VCR. This feature allows you to quickly find a specific program or to find a tape with enough recording space. The SmartFile check list can contain up to 12 programs.

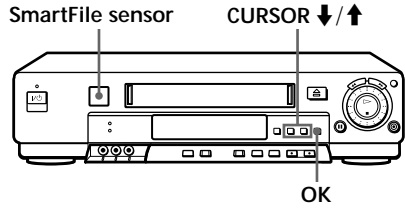

## Before you start...

- Turn on your TV and set it to the video channel.

- 1 Hold the label side of the SmartFile tape close to the SmartFile sensor.

Slowly bring the center of the label within 3 cm of the SmartFile sensor.

There is a short beep, the SMARTFILE indicator lights up, and the SmartFile check list appears.

The BLANK indicator lights up and the Blank Time space also appears in the display window.

- 2 Press CURSOR ↓/↑ repeatedly to turn the pages.

- 3 Press OK on the VCR to exit the menu.

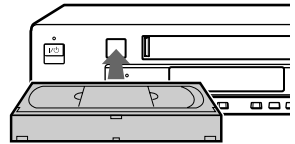

8/10/99-8/30/99		p. 1
BLANK TIME EP 1H48M		
MON	9:00PM CH 16	8/30
SUN	6:30PM CH 4	8/29
FRI	8:00PM CH 12	8/27
FRI	5:45PM CH 7	8/27
THU	1:00PM CH 12	8/26
TUE	4:30PM CH 8	8/24
NEXT: [Left Arrow]		QUIT: [OK]

8/10/99-8/30/99		p. 2
BLANK TIME EP 1H48M		
SUN	6:30PM CH 16	8/22
FRI	8:00PM CH 12	8/20
TUE	9:30PM CH 16	8/17
MON	6:30PM CH 16	8/16
FRI	8:00PM CH 12	8/13
TUE	2:30PM CH 8	8/10
BACK: [Left Arrow]		QUIT: [OK]

## Tips

- The SmartFile check list automatically disappears after about 3 minutes of nonuse.
- If you press SP/EP while the SmartFile check list is displayed, the BLANK TIME remaining tape display changes.
- You can also use the ↑/↓ and OK buttons on the remote commander.
- If you press a button other than SP/EP or OK, the SmartFile check list disappears.

## Notes

- You cannot display the SmartFile check list while:
  - you display the SmartFile list of a different SmartFile tape inserted into the VCR.
  - you display any other menu.
  - you play back the tape at any speed other than normal.
- If the SmartFile check list doesn't appear on the TV screen, try again by drawing the SmartFile tape away from the SmartFile sensor at least 5 cm, then bring it back to within 3 cm of the sensor.
- If you press OK on the remote commander while a tape is inserted into the VCR, playback starts.

# Labeling a recorded program and tape

You can electronically “label” a program and select a category, such as SPECIAL or MOVIE, for a recorded program in the SmartFile list. You can also label a tape. Up to 18 characters can be input for a program and tape label.

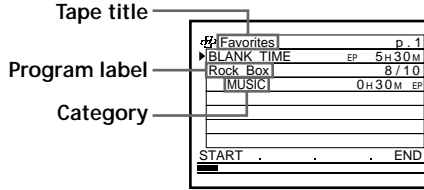

## Labeling a recorded program and selecting a category

Before you start...

- Turn on your TV and set it to the video channel.

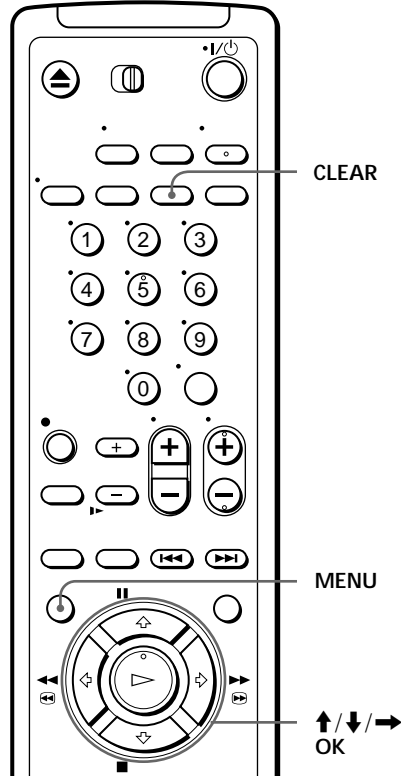

- 1 Insert a SmartFile tape.  
The VCR turns on and the SMARTFILE indicator lights up.

continued

## Labeling a recorded program and tape (continued)

- 2 Press MENU, then press  $\uparrow/\downarrow$  to select SMARTFILE EDIT and press OK.

The SMARTFILE EDIT menu appears.

SMARTFILE EDIT	p. 1
8/10/99-8/16/99	
MON 6:30PM CH 16	8/16
	0H30M SP
FRI 8:00PM CH 12	8/13
	0H50M SP
TUE 2:30PM CH 8	8/10
	0H30M EP
SELECT : $\uparrow/\downarrow$	QUIT : MENU
CATEGORY : $\leftarrow$	TITLE : $\rightarrow$

- 3 Press  $\uparrow/\downarrow$  to select a program.

SMARTFILE EDIT	p. 1
8/10/99-8/16/99	
MON 6:30PM CH 16	8/16
	0H30M SP
FRI 8:00PM CH 12	8/13
	0H50M SP
TUE 2:30PM CH 8	8/10
	0H30M EP
SELECT : $\uparrow/\downarrow$	QUIT : MENU
CATEGORY : $\leftarrow$	TITLE : $\rightarrow$

- 4 Press  $\rightarrow$ .

The cursor moves to the program label input position.

SMARTFILE EDIT	p. 1
8/10/99-8/16/99	
MON 6:30PM CH 16	8/16
	0H30M SP
	8/13
	0H50M SP
TUE 2:30PM CH 8	8/10
	0H30M EP
SELECT : $\uparrow/\downarrow$	CONFIRM : OK
BACK : $\leftarrow$	NEXT : $\rightarrow$

- 5 Label the program.

- 1 Press  $\uparrow/\downarrow$  to select a character.

Each time you press  $\downarrow$ , the character changes as shown below.

A  $\rightarrow$  B  $\rightarrow$  ...  $\rightarrow$  Z  $\rightarrow$  symbol  $\rightarrow$  0  $\rightarrow$   
 1  $\rightarrow$  ... 9  $\rightarrow$  a  $\rightarrow$  b  $\rightarrow$  ...  $\rightarrow$  z  $\rightarrow$   
 (blank space)

If you make a mistake, press CLEAR.

- 2 To set the next character, press  $\rightarrow$ .

The cursor moves to the next position.

SMARTFILE EDIT	p. 1
8/10/99-8/16/99	
MON 6:30PM CH 16	8/16
	0H30M SP
N	8/13
	0H50M SP
TUE 2:30PM CH 8	8/10
	0H30M EP
SELECT : $\uparrow/\downarrow$	CONFIRM : OK
BACK : $\leftarrow$	NEXT : $\rightarrow$

- 3 Repeat steps 1 and 2 to label the program.

SMARTFILE EDIT	p. 1
8/10/99-8/16/99	
MON 6:30PM CH 16	8/16
	0H30M SP
N	8/13
	0H50M SP
TUE 2:30PM CH 8	8/10
	0H30M EP
SELECT : $\uparrow/\downarrow$	CONFIRM : OK
BACK : $\leftarrow$	NEXT : $\rightarrow$

- 6 Press OK.

SMARTFILE EDIT	p. 1
8/10/99-8/16/99	
MON 6:30PM CH 16	8/16
	0H30M SP
Nick & Matt	8/13
	0H50M SP
TUE 2:30PM CH 8	8/10
	0H30M EP
SELECT : $\uparrow/\downarrow$	CONFIRM : OK

**7** Press **↑/↓** to select a category.

Each time you press **↓**, the category changes as shown below.

**SPECIAL** → **MOVIE** → **NEWS** → **SHOW** →  
**SPORTS** → **KIDS** → **MUSIC** → **ARTS** →  
**SERIES** → **EDUCATI** (education) → **HOBBY** →  
**SHOPPIN** (shopping) → **VARIETY** →  
**COMEDY** → **DRAMA** → **DAYTIME** →  
**HOW TO** → **OTHERS** → (blank)

SMARTFILE EDIT		p. 1
8/10/99-8/16/99		
MON	6 : 30 PM CH 16	8 / 16
Nick & Matt		0H 30M SP
COMEDY		8 / 13
TUE	2 : 30 PM CH 8	8 / 10
0H 30M EP		
SELECT :	<b>↓</b>	CONFIRM : <b>OK</b>

**8** Press **OK**.

The program label and a selected category are stored.

**9** Press **MENU** to exit the menu.

### To erase the program label

Press **CLEAR** after step 3 above. The program label is erased and the recording start time and channel number reappear.

### To erase the selected category

Press **CLEAR** in step 7 above. The selected category is erased and the space becomes blank.

### To label a regularly scheduled timer-recorded program

Once you label a program which is set to record regularly (i.e. everyday, same day of the week, etc.) in the VCR Plus+ GOLD system or timer recording mode, the VCR recognizes the label and will automatically label all future recordings of the same program. The set label is assigned even when an information signal containing the program name, category name or other information is broadcast with the program. However, if you change the program label and category several times, the VCR may automatically label only the last program of which the program label and category are changed.

**continued**

## Labeling a recorded program and tape (continued)

### Labeling a tape

Before you start...

- Turn on your TV and set it to the video channel.

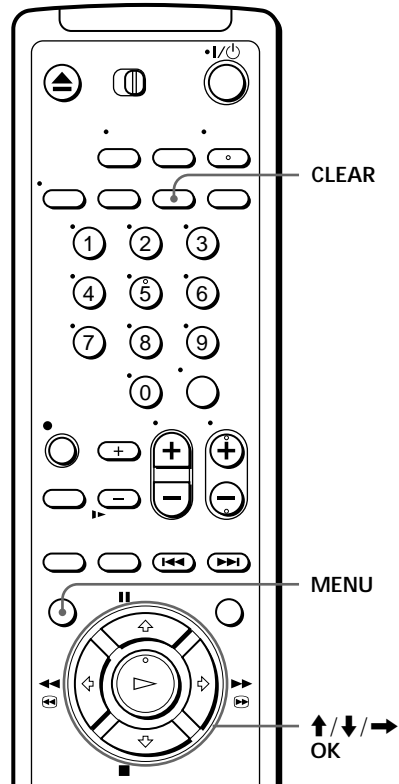

- 1 Insert a SmartFile tape.
- 2 Press MENU, then press **↑/↓** to select SMARTFILE EDIT and press OK.  
The SMARTFILE EDIT menu appears.
- 3 Press **↑** to select the tape title.

SMARTFILE EDIT	p. 1
8/10/99-8/16/99	
Someday	8 / 16
DRAMA	0H30M SP
Nick & Matt	8 / 13
COMEDY	0H50M SP
Rock Box	8 / 10
MUSIC	0H30M EP
SELECT : <b>↑/↓</b>	QUIT : MENU
CATEGORY : <b>←/→</b>	TITLE : <b>←/→</b>

SMARTFILE EDIT	p. 1
8/10/99-8/16/99	
Someday	8 / 16
DRAMA	0H30M SP
Nick & Matt	8 / 13
COMEDY	0H50M SP
Rock Box	8 / 10
MUSIC	0H30M EP
SELECT : <b>←/→</b>	QUIT : MENU
TITLE EDIT : <b>←/→</b>	



#### 4 Press →.

The cursor moves to the tape title input position.

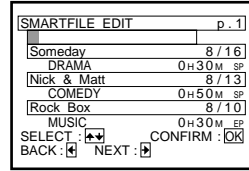

#### 5 Label the tape.

- ① Press ↑/↓ to select a character.

Each time you press ↓, the character changes as shown below.

A → B → ... → Z → symbol → 0 →  
1 → ... 9 → a → b → ... → z →  
(blank space)

If you make a mistake, press CLEAR.

- ② To set the next character, press →.

The cursor moves to the next position.

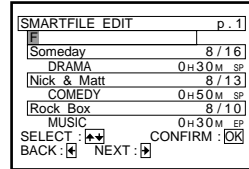

- ③ Repeat steps ① and ② to label the tape.

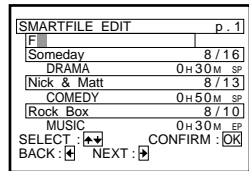

#### 6 Press OK.

The tape title is stored.

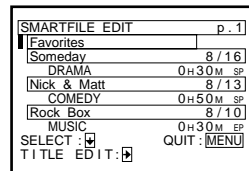

#### 7 Press MENU to exit the menu.

##### To erase the tape title

Press CLEAR after step 3 above. The tape title is erased and the recording date reappears. When you want to erase the recording date from the tape title column, press CLEAR again.

# Protecting a recorded program

You can protect a recorded program using the SmartFile function from accidental over-recording or erasure. When you start recording from a position prior to the protected program, the recording stops automatically before the protected program.

## Before you start...

- Turn on your TV and set it to the video channel.

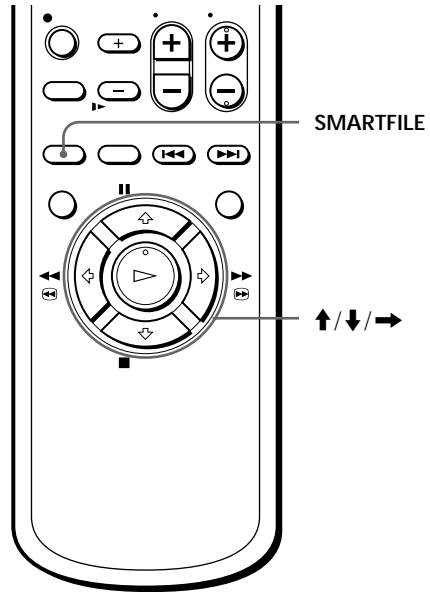

- 1 Insert a SmartFile tape.  
The VCR turns on and the SMARTFILE indicator lights up.

- 2 Press SMARTFILE.  
The SmartFile search list appears on the TV screen.  
The BLANK indicator lights up and the Blank Time space also appears in the display window.

8/10/99-8/16/99	p. 1
▶ BLANK TIME	EP 1H 48M
MON 6:30PM CH 16	8/16
	0H 30M SP
FRI 8:00PM CH 12	8/13
	0H 50M SP
TUE 2:30PM CH 8	8/10
	0H 30M EP
START . . . . .	END

- 3 Press ↑/↓ to select the program you want to protect.

8/10/99-8/16/99	p. 1
▶ BLANK TIME	EP 1H 48M
MON 6:30PM CH 16	8/16
	0H 30M SP
▶ FRI 8:00PM CH 12	8/13
	0H 50M SP
TUE 2:30PM CH 8	8/10
	0H 30M EP
START . . . . .	END

- 4 Press →.  
The  indicator appears to the left of the selected program and the program becomes protected.

8/10/99-8/16/99	p. 1
▶ BLANK TIME	EP 1H 48M
MON 6:30PM CH 16	8/16
	0H 30M SP
▶  FRI 8:00PM CH 12	8/13
	0H 50M SP
TUE 2:30PM CH 8	8/10
	0H 30M EP
START . . . . .	END

- 5 Press SMARTFILE.  
The SmartFile search list disappears.

---

## To unlock the protected program

Press ◀ in step 4 above. The  indicator disappears and you can record over this program.

### Tips

- When you start recording from a position prior to the protected program, the recording automatically stops no more than about 3 minutes in SP mode and about 8 minutes in EP mode before the beginning of the protected program.
- If you protect a program just after the Blank Time space, BLANK TIME becomes shortened by about 3 minutes in SP mode and about 8 minutes in EP mode.
- If you try to record on a SmartFile tape containing a protected program, a message indicating that there is a protected program on this tape appears on the TV screen.
- If you set SMARTFILE LIST to AUTO in the ADVANCED OPTIONS menu, the SmartFile search list appears automatically when you insert a SmartFile tape (see page36).

### Notes

- When you record another program just after a protected program, locate the beginning of the Blank Time space by following the instructions in “Recording after locating the Blank Time space” on page 44. Otherwise, if the recording start point overlaps the protected program, the VCR may record over the protected program.
- If the VCR Plus+ GOLD system or timer recording program overlaps the protected program, the VCR automatically stops recording before the protected program and ejects the tape.
- If you insert a SmartFile tape which contains a protected program or protect a program for the first time on a new tape, the VCR will analyze the position of the protected program for a few seconds. You cannot operate the VCR while the VCR is analyzing the tape.
- If the SmartFile list contains 12 protected programs, the next program you record won't be stored in the SmartFile list.

# Erasing the data of an unwanted program

You can erase an unwanted program from the SmartFile list. When you erase a program from the list, that portion of tape is subject to Blank Time space priority.

## Before you start...

- Turn on your TV and set it to the video channel.

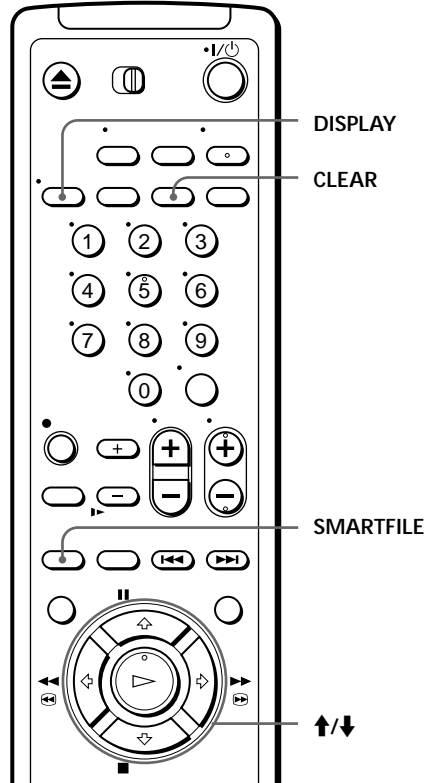

**1** Insert a SmartFile tape.

The VCR turns on and the SMARTFILE indicator lights up.

**2** Press SMARTFILE.

The SmartFile search list appears on the TV screen.

The BLANK indicator lights up and the Blank Time space also appears in the display window.

8/10/99-8/16/99	p. 1
BLANK TIME	EP 1H48M
MON 6:30PM CH 16	8/16
	0H30M SP
FRI 8:00PM CH 12	8/13
	0H50M SP
TUE 2:30PM CH 8	8/10
	0H30M EP
START	END

- 3 Press **↑/↓** to select a program you want to erase from the list.

#	8/10/99-8/16/99	p. 1
BLANK TIME EP 1H 48M		
MON	6:30 PM CH 16	8/16
		0H 30M SP
▶ FRI	8:00 PM CH 12	8/13
		0H 50M SP
TUE	2:30 PM CH 8	8/10
		0H 30M EP
START	.	END

- 4 Press **CLEAR**.

The selected program is erased from the SmartFile list.

If you erase a program by mistake, press **DISPLAY** to make the program reappear.

#	8/10/99-8/16/99	p. 1
BLANK TIME EP 2H 30M		
MON	6:30 PM CH 16	8/16
		0H 30M SP
▶ TUE	2:30 PM CH 8	8/10
		0H 30M EP
START	.	END

- 5 Press **SMARTFILE**.

The SmartFile search list disappears.

#### Tip

- If you set **SMARTFILE LIST** to **AUTO** in the **ADVANCED OPTIONS** menu, the SmartFile search list appears automatically when you insert a SmartFile tape (see page 36).

#### Notes

- You cannot erase a protected program from the SmartFile list. You have to first unlock the protected program by following the instructions in "To unlock the protected program" on page 59, then erase that program from the list.
- If a program is left about 15 minutes or less in **EP** mode, or about 5 minutes or less in **SP** mode, you cannot make the program reappear by using the **DISPLAY** button.

# Registering the contents of a recorded tape in the SmartFile label

The VCR will register programs recorded on a tape in the memory of a new SmartFile label by detecting the index signals indicating the start of recorded programs. You can register up to the 12th program from the start of the tape. The programs appear from the bottom of the screen as Program No.1, Program No.2, ... Program No.12 in order from the start of the tape. The 13th and subsequent programs are ignored. You can manually name the registered program numbers and select the category (see page 53).

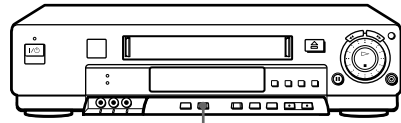

SMARTFILE GENERATOR

## Before you start...

- Turn on your TV and set it to the video channel.

- 1 Attach a new SmartFile label to a recorded cassette tape.
- 2 Insert the SmartFile tape.
- 3 Press SMARTFILE GENERATOR.

A message appears indicating that the recorded programs are being registered. The index signals are detected from the start of the tape, and registration stops if the end of the tape is reached. The message disappears when registration is complete.

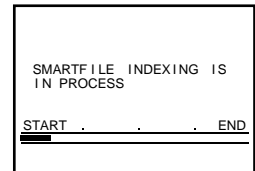

## To stop registration to the SmartFile label

Press SMARTFILE GENERATOR.

The data registered before the button is pressed remains in the SmartFile label. You can register the programs again by pressing SMARTFILE GENERATOR.

## To check the information of a registered program

Press SMARTFILE.

The SmartFile search list appears. The registered program number, registration date and recording time appear in this list. Note that the registration date differs from the recorded date.

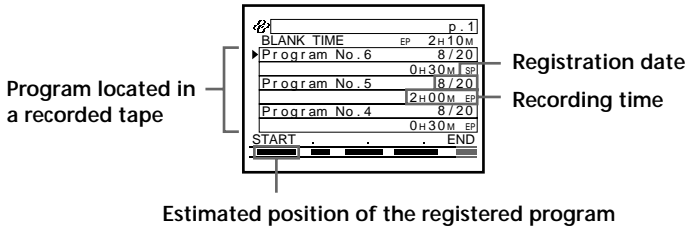

### Tips

- The programs recorded on the tape can be registered again in a SmartFile label that already contains program data. However, the recorded date and time, program name and information input manually (such as the program label and category) are replaced with "Program No. XX".
- If the SmartFile label contains stored program data that includes protected programs, a message appears and registration stops.

### Notes

- Program data is not registered correctly in the SmartFile label when:
  - the program length is about 20 minutes or less in EP mode or about 7 minutes or less in SP mode.
  - the program does not have an index signal or the index signal has been recorded over and erased.
  - the tape is damaged or dirty.
- If you don't set the clock or the clock isn't set to the correct date, the registration date won't be stored correctly on the SmartFile list.
- After you press SMARTFILE GENERATOR and start registration, registration is interrupted if you press ■ STOP, ▷ PLAY, ⏮ ⏪, ⏩ ⏭, ⏪ ⏩, ⏮ ⏭, I/⏻ or ⏮/⏭. In these cases as well, the data registered up to the point when registration was interrupted remains in the SmartFile label.
- Tape speed may not be registered correctly when:
  - you set AUTO TAPE SPEED to ON in the ADVANCED OPTIONS menu, and the tape speed automatically changes from SP to EP during recording.
  - you use tapes recorded in the LP mode on other VCRs.

# Storing program data from the DIRECTV digital satellite receiver (Program Data Download)

If you connect a DIRECTV digital satellite receiver equipped with the Program Data Download function and use the timer recording of the DIRECTV digital satellite receiver, the program and category name transmitted from the DIRECTV digital satellite receiver are stored on the SmartFile tape. The DIRECTV digital satellite receiver equipped with the Program Data Download function will be available in the future.

## How to hook up to the DIRECTV digital satellite receiver

You should connect CPD IN of the VCR and VCR CONTROL of the DIRECTV digital satellite receiver using the supplied monaural cable.

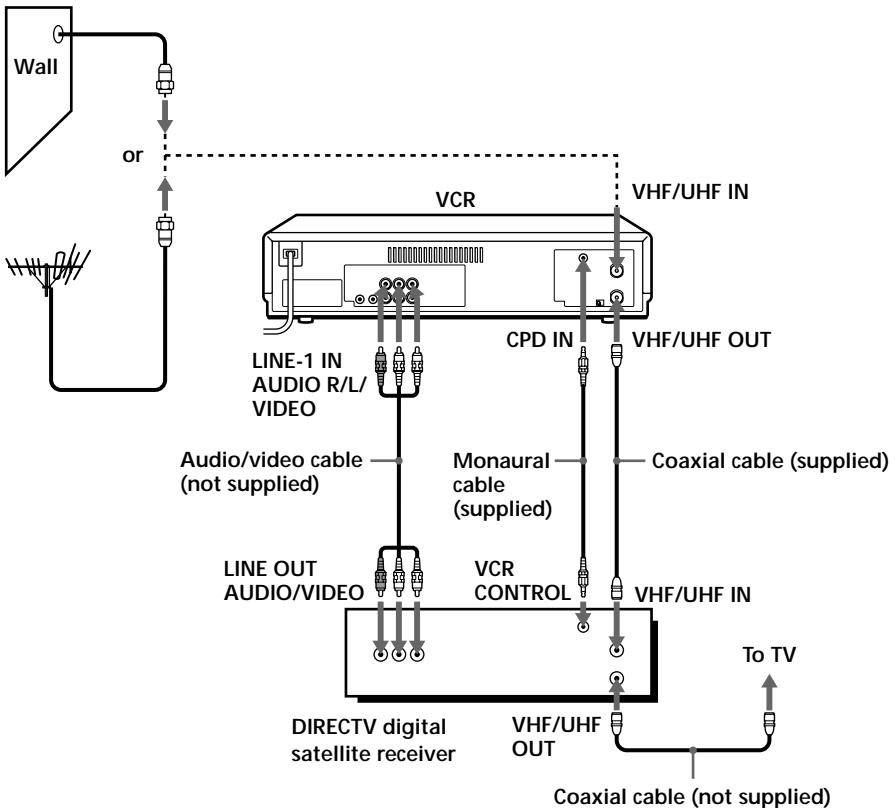



## Setting up the DIRECTV digital satellite receiver

You have to set the VCR brand number on the DIRECTV digital satellite receiver. For example, select "99" in the VCR CONTROL menu to use a Sony VCR with the SmartFile function. For details, refer to the instruction manual of your DIRECTV digital satellite receiver.

## Storing program data on the SmartFile tape

When you record a DIRECTV digital satellite program using the DIRECTV digital satellite receiver's timer, the program and category name are automatically stored on the SmartFile tape.

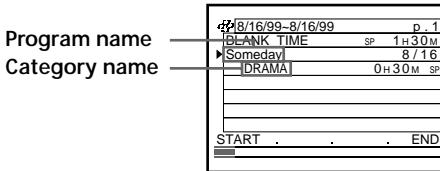

### Notes

- Do not operate the VCR, the DIRECTV digital satellite receiver, and any other equipment connected to these units for at least 2 minutes after timer recording starts. If you operate these equipment immediately after timer recording starts, the correct program data may not be sent from the DIRECTV digital satellite receiver.
- When you use the VCR's timer for recording, program data from the DIRECTV digital satellite receiver is not stored on the SmartFile tape.

# Troubleshooting

If you have any questions or problems not covered below, please consult your nearest Sony dealer.

	Symptom	Remedy
Power	The I/⏻ switch does not function.	<ul style="list-style-type: none"> <li>• Connect the AC power cord securely.</li> <li>• Make sure the VCR is not locked. To unlock, hold down I/⏻ POWER <u>on the VCR</u> until the  indicator disappears.</li> </ul>
	The power is turned on but the VCR does not operate.	<ul style="list-style-type: none"> <li>• Moisture condensation occurs. Turn the power off, unplug the AC power cord and leave the VCR to dry for over three hours.</li> </ul>
Clock	The clock has stopped and "--:--" lights in the display window.	<ul style="list-style-type: none"> <li>• The clock stops if the VCR is disconnected from the wall outlet for more than one hour. Reset the clock (and timer).</li> </ul>
Playback	The playback picture does not appear on the TV screen.	<ul style="list-style-type: none"> <li>• Make sure the TV is set to the channel for the VCR. If you are using a monitor, set it to video input.</li> </ul>
	The picture is not clear.	<ul style="list-style-type: none"> <li>• Adjust the tracking with the TRACKING +/- buttons.</li> <li>• The video heads are dirty (see below). Clean the video heads using the Sony T-25CLD, T-25CLDR, or T-25CLW video head cleaning cassette. If these cleaning cassettes are not available in your area, have the heads cleaned at your nearest Sony service facility (a standard service fee will be charged). Do not use a commercially available liquid type cleaning cassette other than Sony's, as it may damage the video heads.</li> <li>• The video heads may have to be replaced. Consult your local Sony dealer for more information.</li> </ul>
	The picture rolls vertically during picture search.	<ul style="list-style-type: none"> <li>• Adjust the vertical hold control on the TV or monitor.</li> </ul>
	The picture has no sound.	<ul style="list-style-type: none"> <li>• The tape is defective.</li> <li>• If you made A/V connections, check the audio cable connection.</li> </ul>

## Symptoms caused by contaminated video heads

• Normal picture

• Rough picture

• Unclear picture

• No picture (or black & white screen appears)



initial  
contamination



terminal

	Symptom	Remedy
Recording	A TV program does not appear on the TV screen.	<ul style="list-style-type: none"> <li>• Make sure the TV is set to the channel for the VCR. If you are using a monitor, set it to video input.</li> <li>• Select the correct source with the INPUT SELECT button. Select a channel number when recording TV programs; select "L1" or "L2" when recording from other equipment.</li> </ul>
	TV reception is poor.	<ul style="list-style-type: none"> <li>• Adjust the TV antenna.</li> </ul>
	The tape starts playing as soon as it is inserted.	<ul style="list-style-type: none"> <li>• The safety tab has been removed. To record on this tape, cover the tab hole.</li> </ul>
	The tape is ejected when you press ● REC.	<ul style="list-style-type: none"> <li>• Check that the safety tab has not been removed.</li> </ul>
	Nothing happens when you press ● REC.	<ul style="list-style-type: none"> <li>• Make sure the tape is not at its end.</li> <li>• The current position of the tape is record protected. Search for the recording available space.</li> </ul>
	Recording stops halfway.	<ul style="list-style-type: none"> <li>• If the tape contains a protected program, recording automatically stops before the protected program. Use another tape which has enough recording space.</li> </ul>
Timer recording	The timer does not operate.	<ul style="list-style-type: none"> <li>• Check that the clock is set.</li> <li>• Make sure a tape has been inserted.</li> <li>• Check that the safety tab has not been removed.</li> <li>• Make sure the tape is not at its end.</li> <li>• The recording start point overlaps the protected program.</li> <li>• Make sure a program has been set for timer recording.</li> <li>• Make sure your timer settings have not already passed the current time.</li> <li>• Check that the cable box is turned on.</li> <li>• The clock stops if the VCR is disconnected from the wall outlet for more than one hour. Reset the clock and timer.</li> <li>• When you use cable box control, make sure the CABLE BOX CONTROL option is set to ON.</li> </ul>

**continued**

## Troubleshooting (continued)

	Symptom	Remedy
	A tape cannot be inserted.	<ul style="list-style-type: none"><li>• Check that a tape isn't already in the tape compartment.</li></ul>
	The remote commander does not function.	<ul style="list-style-type: none"><li>• Make sure you are pointing the remote commander at the remote sensor on the VCR.</li><li>• Replace all the batteries in the remote commander with new ones if they are weak.</li><li>• Make sure the <b>TV</b>/<b>RECEIVER</b>/<b>VIDEO</b> switch is set correctly.</li><li>• If you are not using S-Link™ make sure that both miniplugs are unconnected.</li></ul>
Others	The channels on the VCR cannot be changed.	<ul style="list-style-type: none"><li>• Make sure the CABLE BOX CONTROL option is set to OFF.</li></ul>
	The tracking meter does not appear on the screen.	<ul style="list-style-type: none"><li>• The recording condition of the tape is very poor and tracking cannot be adjusted.</li></ul>
	You cannot control other TVs.	<ul style="list-style-type: none"><li>• Set your TV's code number. The code number may change when you replace the batteries of the remote commander.</li></ul>
	The SMARTFILE screen appears when a tape is not inserted.	<ul style="list-style-type: none"><li>• Press <b>■</b> STOP to close the SMARTFILE demonstration screen.</li></ul>
	The VCR needs to be cleaned.	<ul style="list-style-type: none"><li>• Clean the cabinet, panel and controls with a dry, soft cloth, or a soft cloth slightly moistened with a mild detergent solution. Do not use any type of solvent, such as alcohol or benzine.</li></ul>

# Specifications

## System

### Format

VHS NTSC standard

### Video recording system

Rotary head helical scanning FM system

### Video heads

Double azimuth four heads

### Video signal

NTSC color, EIA standards

### Tape speed

SP: 33.35 mm/s ( $1\frac{3}{8}$  inches/s)

EP: 11.11 mm/s ( $\frac{7}{16}$  inches/s)

LP: 16.67 mm/s ( $1\frac{1}{16}$  inches/s),  
playback only

### Maximum recording/playback time

8 hrs. in EP mode (with T-160 tape)

### Fast-forward and rewind time

Approx. 1 min. (with T-120 tape)\*

\* The time may vary according to the brand  
and/or type of tape or the operating  
condition of the VCR.

## Tuner section

### Channel coverage

VHF 2 to 13

UHF 14 to 69

CATV A-8 to A-1, A to W, W+1 to W+84

### Antenna

75-ohm antenna terminal for VHF/UHF

## Inputs and outputs

### LINE-1 IN and -2 IN

VIDEO IN, phono jack (1 each)

Input signal: 1 Vp-p, 75 ohms, unbalanced,  
sync negative

AUDIO IN, phono jacks (2 each)

Input level: 327 mVrms

Input impedance: more than 47 kilohms

### LINE OUT

VIDEO OUT, phono jack (1)

Output signal: 1 Vp-p, 75 ohms, unbalanced,  
sync negative

AUDIO OUT, phono jacks (2)

Standard output: 327 mVrms

Load impedance: 47 kilohms

Output impedance: less than 10 kilohms

### S-LINK (CONTROL S IN)

Mini jack (1)

### CABLE BOX CONTROL (CONTROL S OUT)

Stereo mini jack (plug in power) (1)

### CPD IN

Mini jack (1)

## Timer section

### Clock

Quartz locked

### Timer indication

12-hour cycle

### Timer setting

8 programs per month (max.)

### Power back-up

Built-in self-charging capacitor

Back-up duration: up to 1 hour at a time

## General

### Power requirements

120 V AC, 60 Hz

### Power consumption

35 W

### Operating temperature

5°C to 40°C (41°F to 104°F)

### Storage temperature

-20°C to 60°C (-4°F to 140°F)

### Dimensions

Approx. 430 × 100 × 281 mm (w/h/d)

Approx. (17 × 4 × 11  $\frac{1}{8}$  inches)

including projecting parts and controls

### Mass

Approx. 4.5 kg (9 lb 15 oz)

## Supplied accessories

Remote commander (1)

Size AA (R6) batteries (2)

75-ohm coaxial cable with F-type connectors (1)

Audio/video cable (3-phono, 1-mini to 3-phono,  
1-mini) (1)

Monaural cable (1-mini to 1-mini) (1)

Cable Mouse (cable box controller) (1)

SmartFile labels (5)

Design and specifications are subject to change  
without notice.

# Index to parts and controls

Refer to the pages indicated in parentheses ( ) for details.

## Front panel

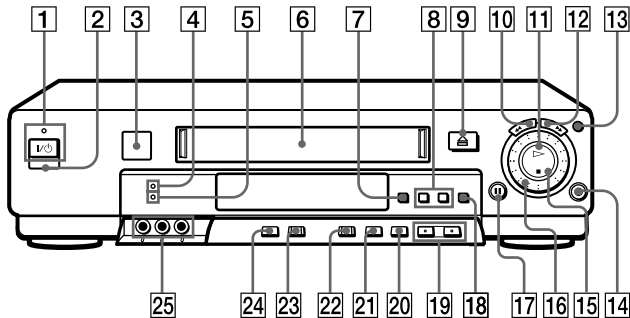

- |   |  |
|---|--|
| <b>1</b> I/⏻ POWER switch/indicator (14)      | <b>14</b> ● REC (record) button (8, 26, 38)    |
| <b>2</b> Remote sensor                        | <b>15</b> ■ STOP button (5, 38)                |
| <b>3</b> SmartFile sensor (39, 52)            | <b>16</b> Shuttle ring (9, 21)                 |
| <b>4</b> SMARTFILE indicator (44, 52)         | <b>17</b>    PAUSE button (5, 38)              |
| <b>5</b> REALITY REGENERATOR indicator (32)   | <b>18</b> OK button (16, 45, 52)               |
| <b>6</b> Tape compartment                     | <b>19</b> CHANNEL/TRACKING +/- buttons (8, 32) |
| <b>7</b> SMARTFILE button (42, 50, 58)        | <b>20</b> EDIT button (38)                     |
| <b>8</b> CURSOR ↓/↑ buttons (52)              | <b>21</b> REALITY REGENERATOR button (32)      |
| <b>9</b> ≡ EJECT button (5)                   | <b>22</b> EASY SET UP button                   |
| <b>10</b> ◀◀ REW (rewind) button (5, 20)      | <b>23</b> SMARTFILE GENERATOR button (62)      |
| <b>11</b> ▷ PLAY button (5, 21)               | <b>24</b> INPUT SELECT button (8, 10, 38)      |
| <b>12</b> ▶▶ FF (fast-forward) button (5, 20) | <b>25</b> LINE-2 IN VIDEO/AUDIO L/R jacks (37) |
| <b>13</b> JOG button (22)                     |  |

## Display window

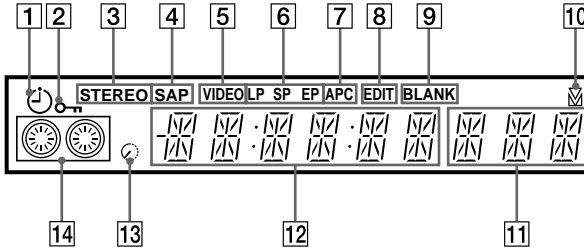

- |  |  |
|--|--|
| <b>1</b> Timer indicator (14, 17)                      | <b>8</b> EDIT indicator (38)               |
| <b>2</b> Child Lock indicator (15)                     | <b>9</b> BLANK indicator (44)              |
| <b>3</b> STEREO indicator (29)                         | <b>10</b> Tracking indicator (32)          |
| <b>4</b> SAP (Second Audio Program) indicator (29)     | <b>11</b> Line/channel indicator (8, 38)   |
| <b>5</b> VIDEO indicator (9)                           | <b>12</b> Time counter/clock indicator (6) |
| <b>6</b> Tape speed indicator (8)                      | <b>13</b> Remaining time indicator (9)     |
| <b>7</b> APC (Adaptive Picture Control) indicator (33) | <b>14</b> Tape/recording indicator (8)     |

continued

## Index to parts and controls (continued)

### Rear panel

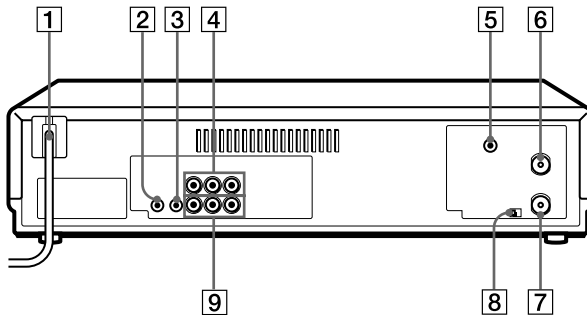

- |  |   |
|--|---|
| <b>1</b> AC power cord                               | <b>6</b> VHF/UHF IN connector (64)        |
| <b>2</b> S-LINK (CONTROL S IN) jack (37)             | <b>7</b> VHF/UHF OUT connector (64)       |
| <b>3</b> CABLE BOX CONTROL (CONTROL S OUT) jack      | <b>8</b> RF (Radio Frequency) UNIT switch |
| <b>4</b> LINE-1 IN AUDIO R/L/VIDEO jacks (37, 64)    | <b>9</b> LINE OUT AUDIO R/L/VIDEO jacks   |
| <b>5</b> CPD (Control and Program Data) IN jack (64) |   |



## Remote commander

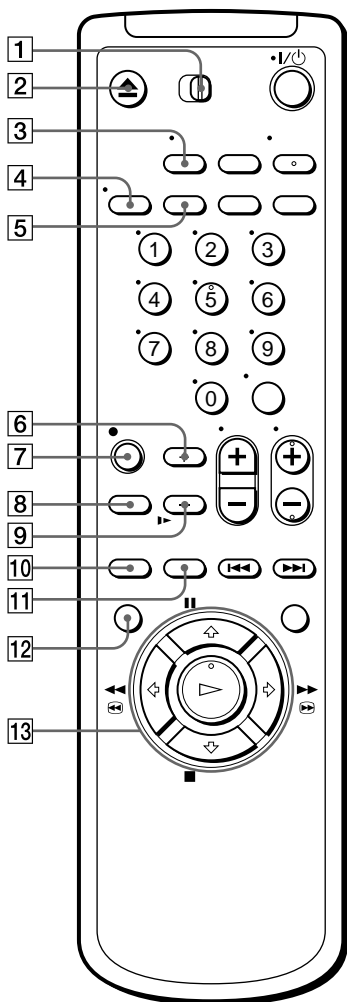

- 1 TV/RECEIVER/VIDEO switch
- 2 ▲ EJECT button (5)
- 3 TV/VIDEO button (9)
- 4 DISPLAY button (9)
- 5 SP (Standard Play)/EP (Extended Play) button (8, 45)
- 6 ×2/RECEIVER VOL (volume) + button (20)
- 7 ● REC (record) button (8, 26)
- 8 MUTE button
- 9 ► SLOW/RECEIVER VOL (volume) – button (20)
- 10 SMARTFILE button (42, 50, 58)
- 11 INPUT SELECT button (8, 10, 38)
- 12 MENU button (16, 27)
- 13 ■ PAUSE/▲ button (5, 16, 27, 45)  
 ■ STOP/▼ button (5, 16, 27, 45)  
 ◀◀ ⏮ REW (rewind)/◀ button (5, 14, 20)  
 ▶▶ ⏭ FF (fast-forward)/▶ button (5, 14, 20)  
 ▷ PLAY/OK button (5, 16, 45)

**continued**

## Index to parts and controls (continued)

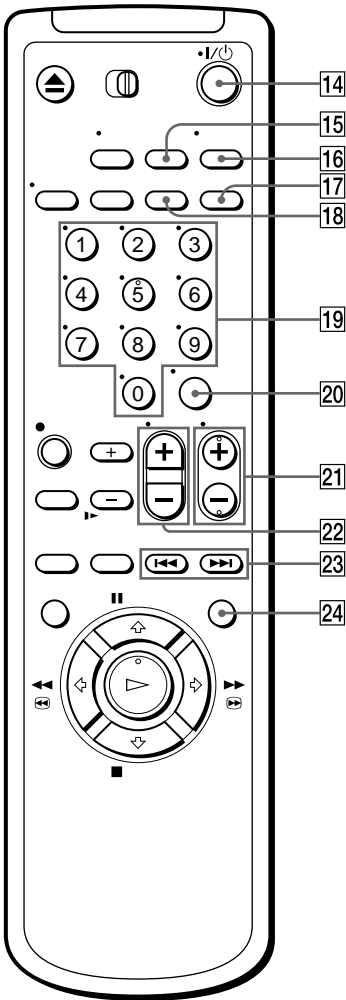

- 14** I/⏻ (power) switch (14)
- 15** COUNTER/REMAIN button (9)
- 16** AUDIO MONITOR button (29)
- 17** VCR Plus+ button (13)
- 18** CLEAR button (6, 14, 28, 57)
- 19** Number buttons (14)
- 20** ENTER button (12, 14, 23)
- 21** CH (channel) +/- buttons (8)
- 22** VOL (volume) +/- buttons
- 23** ◀◀ / ▶▶ INDEX SEARCH buttons (31)
- 24** SMART CUE button (5)

---

# Index

## A, B

- Adjusting
  - picture 32
  - tracking 32
- Advanced option 34
- APC (Adaptive Picture Control) 33
- Audio track 30
- Auto Tape Speed 35

## C

- Child Lock 15
- Cleaning the video heads 66
- Counter 6

## D

- DIRECTV System 64
- Dubbing. *See* Editing.

## E

- Editing 37
- EP mode 8

## F, G

- Favorite channel 23

## H

- Hi-fi audio track 30

## I, J, K

- Index Search 31

## L

- Locking the VCR 15
- LP mode 10

## M

- Monaural 29
- Monitoring audio during playback 29

## N, O

- Normal audio track 30

## P, Q

- Picture adjustment. *See* Adjusting.
- Playback 4
  - at various speeds 20
  - frame-by-frame 21
  - selecting the sound 29
  - skip 5
  - slow motion 20

## R

- Reality Regenerator 32
- Recording 7
  - bilingual programs 29
  - SAP broadcasts 29
  - saving 9
  - stereo broadcasts 29
  - timer setting 16
  - using VCR Plus+ GOLD 13
  - while watching another program 9

## S

- Safety tab 9
- SAP (Second Audio Program) 29
- Searching at various speeds 20
- S-Link™ 37

## SmartFile 39

- checking the contents of a tape 52
- erasing the data of an unwanted program 60
- labeling a recorded program and tape 53
- protecting a recorded program 58
- recording 41
- registering the contents of a recorded tape 62
- selecting 50
- SmartFile label 41
- storing program data from the DIRECTV digital satellite receiver 64

## SP mode 8

## Station ID 11

## Stereo 29

## T, U

- Timer setting 16
  - canceling 27
  - changing 27
  - checking 27
  - daily/weekly recording 18
  - using VCR Plus+ GOLD 13

## Tracking adjustment. *See* Adjusting.

## V, W, X, Y, Z

- VCR Plus+ GOLD recording 13

# Quick reference to using the VCR

## Hookup 1

### To play a tape

- 1 Set the TV to channel 3 or 4 (or to video input, if you made A/V connections.)
- 2 Insert a tape and press  $\triangleright$  PLAY.

### To record a program

- 1 Turn on the cable box.
- 2 Press VCR Plus+ on the remote commander.
- 3 Enter the PlusCode number.
- 4 Select ONCE, DAILY, or WEEKLY, then press ENTER.
- 5 Insert a tape.
- 6 Press  $I/\odot$  to turn off the VCR.
- 7 Leave the cable box on.

### To watch TV

- 1 Turn off your VCR, or press the VCR's TV/VIDEO button until the VIDEO indicator in the display window goes off.
- 2 Turn on your cable box.
- 3 Set the TV to the cable box output channel (usually 2, 3, or 4).
- 4 Set the cable box to the channel you want to watch.

## Hookup 2

### To play a tape

- 1 If you made A/V connections, set the TV to video input. If you didn't use A/V hookup:
  - Turn on the cable box.
  - Set the cable box to channel 3 or 4.
  - Set the TV to the output channel of the cable box (usually 2, 3, or 4).
- 2 Insert a tape and press  $\triangleright$  PLAY.

### To record a program

- 1 Press VCR Plus+ on the remote commander.

- 2 Enter the PlusCode number.
- 3 Select ONCE, DAILY, or WEEKLY, then press ENTER.
- 4 Insert a tape.
- 5 Press  $I/\odot$  to turn off the VCR.

### To watch TV

- 1 Turn off your VCR, or press the VCR's TV/VIDEO button until the VIDEO indicator in the display window goes off.
- 2 Select the channel with your cable box (if you have one) or with your TV.

## Hookup 3

### To play a tape

- 1 Set the TV to channel 3 or 4 (or to video input, if you made A/V connections.)
- 2 Insert a tape and press  $\triangleright$  PLAY. If there's no picture on your TV, press the VCR's TV/VIDEO button until the VIDEO indicator comes on in the display window.

### To record a program

- 1 Press VCR Plus+ on the remote commander.
- 2 Enter the PlusCode number.
- 3 Select ONCE, DAILY, or WEEKLY, then press ENTER.
- 4 Insert a tape.
- 5 Press  $I/\odot$  to turn off the VCR.

### To watch TV

- 1 Turn off your VCR, or press the VCR's TV/VIDEO button until the VIDEO indicator in the display window goes off.
- 2 Set the TV to the channel you want to watch.

## Hookup 4

### To play a tape

- 1 Set the TV to channel 3 or 4 (or to video input, if you made A/V connections.)
- 2 Insert a tape and press  $\triangleright$  PLAY.

### To record a program

- 1 Turn on the cable box.
- 2 Set the cable box to the channel you want to record.
- 3 Press VCR Plus+ on the remote commander.
- 4 Enter the PlusCode number.
- 5 Select ONCE, DAILY, or WEEKLY, then press ENTER.

- 6 Insert a tape.
- 7 Press  $I/\odot$  to turn off the VCR.

- 8 Leave the cable box on.

### To watch TV

- 1 Turn off your VCR, or press the VCR's TV/VIDEO button until the VIDEO indicator in the display window goes off.
- 2 Turn on your cable box.
- 3 Set the TV to the cable box output channel (usually 2, 3, or 4).
- 4 Set the cable box to the channel you want to watch.

### To order additional SmartFile Labels

Please call 1-888-293-9885. Cost is \$9.95 for a package of 5 labels.

If you have any questions about this product, you may call: **Sony Customer Information Center** 1-800-222-SONY (7669) or write to: **Sony Customer Information Center** Sony Drive, Mail Drop #T1-11, Park Ridge, NJ 07656

Sony  line <http://www.world.sony.com/>