

FM Stereo FM-AM Receiver

Operating Instructions

STR-DE310

WARNING

To prevent fire or shock hazard, do not expose the unit to rain or moisture.

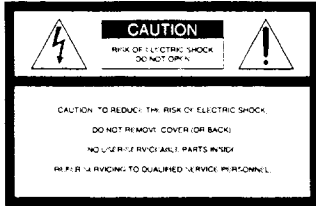

This symbol is intended to alert the user to the presence of uninsulated "dangerous voltage" within the product's enclosure that may be of sufficient magnitude to constitute a risk of electric shock to persons.



This symbol is intended to alert the user to the presence of important operating and maintenance (servicing) instructions in the literature accompanying the appliance.

IMPORTANT

This equipment has been tested and found to comply with the limits for a Class B digital device, pursuant to Part 15 of the FCC Rules.

These limits are designed to provide reasonable protection against harmful interference in a residential installation. This equipment generates, uses, and can radiate radio frequency energy and, if not installed and used in accordance with the instructions, may cause harmful interference to radio communications. However, there is no guarantee that interference will not occur in a particular installation. If this equipment does cause harmful interference to radio or television reception, which can be determined by turning the equipment off and on, the user is encouraged to try to correct the interference by one or more of the following measures:

- Reorient or relocate the receiving antenna.
- Increase the separation between the equipment and receiver.
- Connect the equipment into an outlet on a circuit different from that to which the receiver is connected.
- Consult the dealer or an experienced radio/TV technician for help.

CAUTION

You are cautioned that any change or modifications not expressly approved in this manual could void your authority to operate this equipment.

Note to CATV system installer

This reminder is provided to call the CATV system installer's attention to Article 820-40 of the NEC that provides guidelines for proper grounding and, in particular, specifies that the cable ground shall be connected to the grounding system of the building, as close to the point of cable entry as practical.

Owner's record

The model and serial numbers are located on the rear of the unit. Record the serial number in the space provided below. Refer to them whenever you call upon your Sony dealer regarding this product.

Model No. STR-DE310

Serial No. _____

For the customers in Canada

To avoid electrical shock, do not open the cabinet. Refer servicing to qualified personnel only.

CAUTION:

TO PREVENT ELECTRIC SHOCK, DO NOT USE THIS POLARIZED AC PLUG WITH AN EXTENSION CORD, RECEPTACLE OR OTHER OUTLET UNLESS THE BLADES CAN BE FULLY INSERTED TO PREVENT BLADE EXPOSURE.

Precautions

On safety

- Should any solid object or liquid fall into the cabinet, unplug the receiver and have it checked by qualified personnel before operating it any further.

On power sources

- Before operating the receiver, check that the operating voltage is identical with your local power supply. The operating voltage is indicated on the nameplate at the rear of the receiver.
- The receiver is not disconnected from the AC power source (MAINS) as long as it is connected to the wall outlet, even if the receiver itself has been turned off.
- If you are not going to use the receiver for a long time, be sure to disconnect the receiver from the wall outlet. To disconnect the AC power cord, grasp the plug itself; never pull the cord.
- One blade of the plug is wider than the other for the purpose of safety and will fit into the wall outlet only one way. If you are unable to insert the plug fully into the outlet, contact your dealer.
- Should the AC power cord need to be changed, have it done at a qualified service shop only.

On placement

- Place the receiver in a location with adequate ventilation to prevent heat build-up and prolong the life of the receiver.
- Do not place the receiver near heat sources, or in a place subject to direct sunlight, excessive dust or mechanical shock.
- Do not place anything on top of the cabinet that might block the ventilation holes and cause malfunctions.

On operation

- Before connecting other components, be sure to turn off and unplug the receiver.

On cleaning

- Clean the cabinet, panel and controls with a soft cloth slightly moistened with a mild detergent solution. Do not use any type of abrasive pad, scouring powder or solvent such as alcohol or benzene.

If you have any question or problem concerning your receiver, please consult your nearest Sony dealer.

About This Manual

The instructions in this manual describe the controls on the receiver. You can also use the controls on the remote if they have the same or similar names as those on the receiver.

- A "Quick Reference Guide" is supplied on the back cover.
- The "Remote Button Descriptions" section on page 15 provides an overview of the remote buttons.
- The following icons are used in this manual:



Indicates that you can use only the remote to do the task.



Indicates hints and tips for making the task easier.

TABLE OF CONTENTS

Getting Started

- Unpacking 4
 - Hookup Overview 4
 - Antenna Hookups 5
 - Audio/Video Component Hookups 5
 - Speaker System Hookups 6
 - AC Hookups 7
 - Before You Use Your Receiver 7
-

Receiver Operations

- Selecting a Component 8
 - Receiving Broadcasts 9
 - Presetting Radio Stations 10
 - Recording 11
-

Additional Information

- Troubleshooting 12
 - Specifications 13
-

Index 14

Rear Panel Descriptions 14

Remote Button Descriptions 15

Quick Reference Guide (Back cover)

Unpacking

Check that you received the following items with the receiver:

- FM wire antenna (1)
- AM loop antenna (1)
- Remote controller (remote) (1)
- Size AA (R6) batteries (2)

Inserting batteries into the remote

Insert two size AA (R6) batteries in accordance with the + and - markings on the battery compartment. When using the remote, point it at the remote sensor  on the receiver.

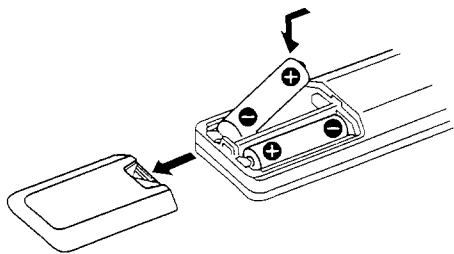

When to replace batteries

Under normal use, the batteries should last for about 6 months. When the remote no longer operates the receiver, replace both batteries with new ones.

Notes

- Do not leave the remote in an extremely hot or humid place.
- Do not use a new battery with an old one.
- Do not expose the remote sensor to direct sunlight or lighting apparatuses. Doing so may cause a malfunction.
- If you don't use the remote for an extended period of time, remove the batteries to avoid possible damage from battery leakage and corrosion.

Hookup Overview

The receiver allows you to connect and control the following audio components. Follow the hookup procedures for the components that you want to connect to the receiver on the pages specified. To learn the locations and names of each jack, see "Rear Panel Descriptions" on page 14.

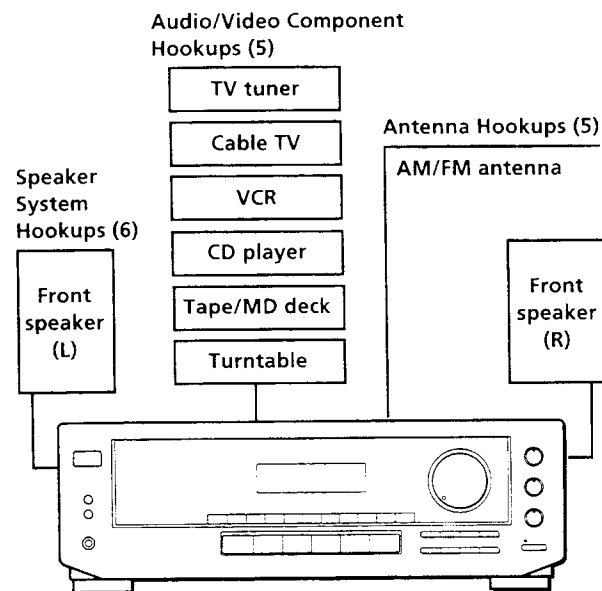

Before you get started

- Turn off the power to all components before making any connections.
- Do not connect the AC power cords until all of the connections are completed.
- Be sure to make connections firmly to avoid hum and noise.
- When connecting an audio cable, be sure to match the color-coded pins to the appropriate jacks on the components: White (left, audio) to White; and Red (right, audio) to Red.

Antenna Hookups

Overview

This section describes how to connect AM and FM antennas to the receiver. If you want to receive radio broadcasts with the receiver, complete these connections first, then go to the following pages. For specific locations of the terminals, see the illustration below.

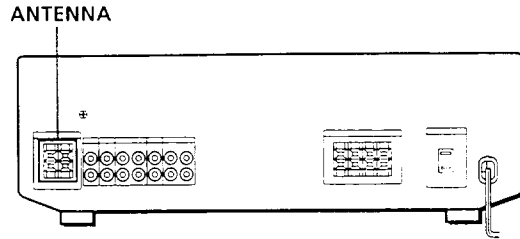

What antennas will I need?

- FM wire antenna (supplied) (1)
- AM loop antenna (supplied) (1)

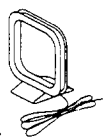

Hookups

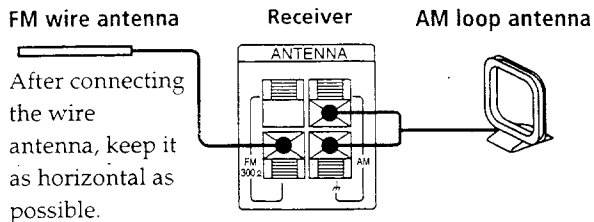

💡 If you have poor FM reception

Connect a 75-ohm coaxial cable (not supplied) to an FM outdoor antenna. Pull back the mesh portion surrounding the inner cable and connect it to the earth terminal (right side). Connect the inner cable to the FM terminal (left side).

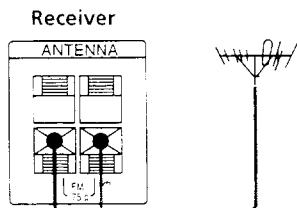

💡 If you have poor AM reception

Connect a 20 to 50 ft. (6 to 15-meter) insulated wire (not supplied) to the AM antenna terminal in addition to the AM loop antenna. Try to extend the wire outdoors and keep it horizontal.

Connecting a ground wire

To prevent hum, connect a ground wire (not supplied) to the \earth ground terminal. If you've connected an outdoor antenna, be sure to connect the ground for lightning protection.

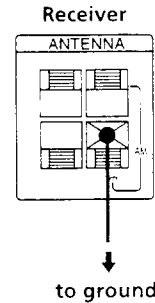

Where do I go next?

If you want to connect other components, go on to the next section. If you're only planning to use the receiver to listen to the radio, go to "Speaker System Hookups" on pages 6 and 7.

Audio/Video Component Hookups

Overview

This section describes how to connect your audio, and video (audio signal only) components to the receiver. If you want to use the receiver as an amplifier, complete these connections.

For specific locations of the jacks, see the illustration below.

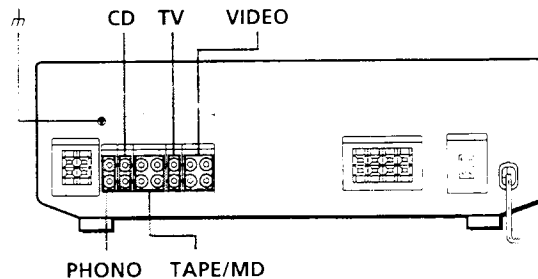

What cords will I need?

Audio cords (not supplied) (1 for each CD player, turntable, TV tuner or cable TV; 2 for each tape deck, MD recorder or VCR)

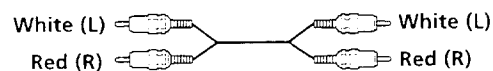

(continued)

Hookups

The arrow  indicates signal flow.

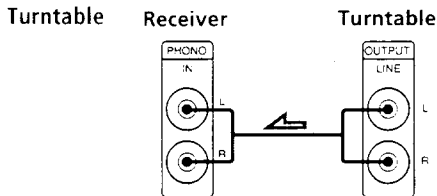
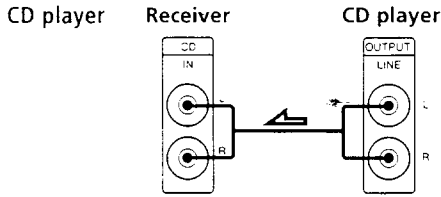

- If your turntable has an earth lead
To prevent hum, connect the earth lead to the h ground terminal on the receiver.

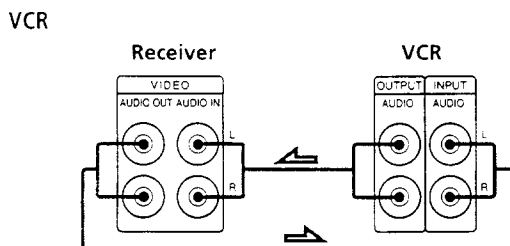
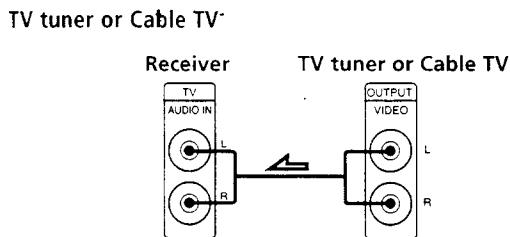
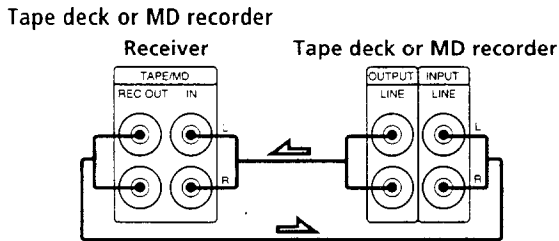

Where do I go next?

Go on to the next section to connect the speakers.

Speaker System Hookups

Overview

This section describes how to connect your speakers to the receiver.

For specific locations of the terminals, see the illustration below.

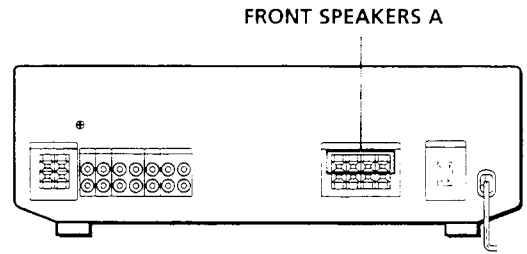

What cords will I need?

Speaker cord (not supplied) (1 for each speaker)



Twist the stripped ends of the cord about 2/3 inch (15 mm). Be sure to match the speaker cord to the appropriate terminal on the components: + to + and - to -. If the cords are reversed, the sound will be distorted and will lack bass.

Hookups

Front speakers

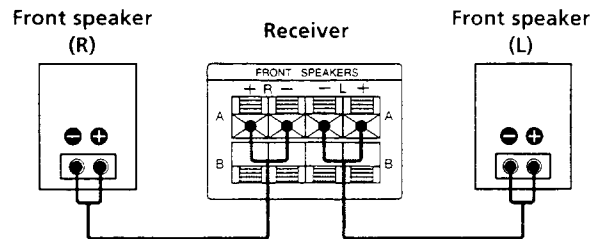

- 💡 If you have an additional front speaker system
Connect them to the FRONT SPEAKERS B terminals.

Selecting the speaker system

To drive the speakers, select the speaker system as follows:

To drive	Depress SPEAKERS button
Speaker system A (connected to the FRONT SPEAKERS A terminals)	A
Speaker system B (connected to the FRONT SPEAKERS B terminals)	B
Both speaker systems A and B (series connection)	A+B

Note

No sound is heard when you press SPEAKERS A+B without connecting speaker system B.

Where do I go next?

Go on to the next section to connect the AC power cord.

AC Hookups

Connecting the AC power cord

Connect the AC power cord from this receiver and from your audio/video components to a wall outlet. If you connect other audio components to the SWITCHED AC OUTLET on the receiver, the receiver can supply power to the connected components so you can turn on/off the whole system when you turn on/off the receiver.

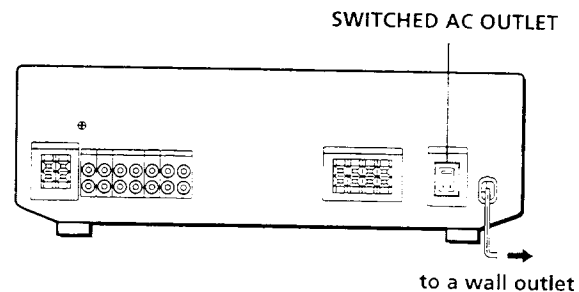

Caution

Make sure that the power consumption of the component connected to the receiver's AC outlet does not exceed 120 watts. Do not connect high-wattage electrical home appliances such as electric irons, fans, or TVs to this outlet.

Where do I go next?

Before you use the receiver, go to the next section to make sure that all the controls are set to the appropriate positions.

Before You Use Your Receiver

Before you start using your receiver, make sure that you have:

- Turned VOLUME to the leftmost position (0).
- Selected the appropriate speaker system. (See "Selecting the speaker system" on this page.)
- Set BALANCE to the center position.

Turn on the receiver and check the following display.

- Press MUTING on the remote if the MUTING is displayed.

Selecting a Component

To listen to a connected component, first select the function on the receiver or with the remote.

Before you begin, make sure you have:

- Connected all components securely and correctly as indicated on pages 5 to 7.
- Turned VOLUME to the leftmost position (0) to avoid damaging your speakers.

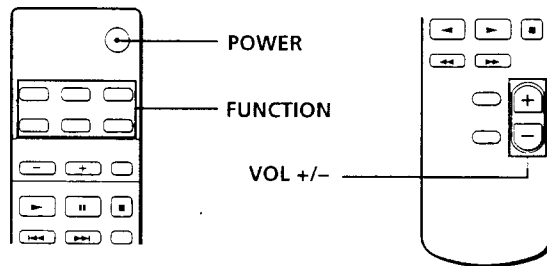
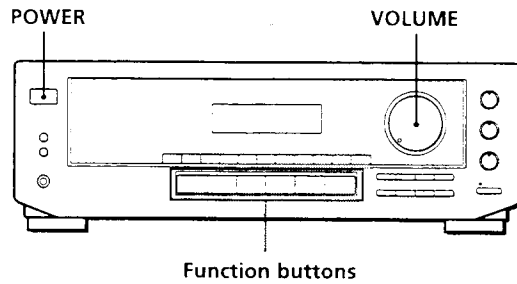

- 1 Press **POWER** to turn on the receiver.
- 2 Press a function button to select the component you want to use:

To listen to or watch	Press
Records	PHONO
Radio programs	TUNER
Compact discs (CD)	CD
Audio tapes or MiniDiscs (MD)	TAPE/MD
TV programs or Cable TV	TV
Video tapes	VIDEO

- 3 Turn on the component, for example, a CD player, and then start playing.
To tune in radio stations on this receiver, see "Receiving Broadcasts" on page 9.
- 4 Turn **VOLUME** or press **VOL +/-** on the remote to adjust the volume.

To	Do this
Mute the sound	Press MUTING on the remote. Press again to restore the sound
Reinforce the bass	Press BASS BOOST to turn on the BASS BOOST indicator.
Adjust the balance	Turn the BALANCE control left or right.
Adjust the tone quality	Adjust the BASS and TREBLE controls.

💡 When you listen with headphones
Connect the headphones to the **PHONES** jack and set the **SPEAKERS** buttons to **OFF**.

To turn off the components
Press **POWER**. You can turn off the video and audio components connected to the **SWITCHED AC OUTLET** at the same time.

Receiving Broadcasts

This receiver lets you enter a station's frequency directly by using the numeric buttons (direct tuning). If you don't know the frequency of the station you want, see "Receiving broadcasts by scanning stations (automatic tuning)" on this page.

Before you begin, make sure you have:

- Connected an FM/AM antenna to the receiver as indicated on page 5.
- Selected the appropriate speaker system. (See "Selecting the speaker system" on page 7.)

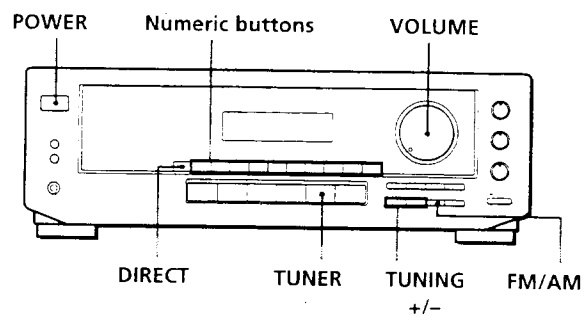

- 1 Press POWER to turn on the receiver.
- 2 Press TUNER.
The last received station is tuned in.
- 3 Press FM/AM to select FM or AM stations.
- 4 Press DIRECT.
- 5 Press the numeric buttons to enter the frequency.

Example 1: FM 102.50 MHz **Example 2: AM 1350 kHz**

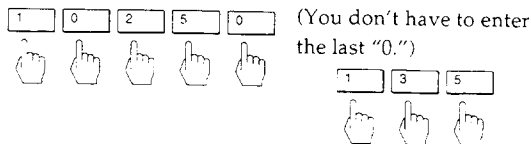

- 6 When you tune in AM stations, adjust the direction of the AM loop antenna for optimum reception.

To receive other stations

Repeat Steps 3 to 5.

💡 If the STEREO indicator remains off

Press FM MODE when an FM stereo broadcast is received.

💡 If an FM stereo program is distorted

The STEREO indicator flashes. Press FM MODE to change to monaural (MONO). You will not have the stereo effect but the distortion will be reduced. To return to stereo mode, press this button again.

💡 If you cannot tune in a station and the entered numbers are flashing

Make sure you've entered the right frequency. If not, press DIRECT and re-enter the frequency you want. If the entered numbers still flash, the frequency is not used in your area.

💡 To watch FM simulcast TV programs

Make sure that you tune in the simulcast program both on the TV (or the VCR) and on the receiver.

💡 If you enter a frequency not covered by the tuning interval

The entered value is automatically rounded up or down to the closest covered value.

Tuning intervals for direct tuning are:

FM: 50 kHz intervals

AM: 10 kHz intervals (to change to 9 kHz intervals, see page 13)

Receiving broadcasts by scanning stations (automatic tuning)

If you don't know the frequency of the radio station you want, you can have the receiver scan all the receivable stations to locate the one you want.

- 1 Press TUNER.
The last received station is tuned in.
- 2 Press FM/AM to select FM or AM.
- 3 Press TUNING + or -.
Press the + button for a higher station number; press the - button for a lower one. When you tune past either end of the band, the receiver automatically jumps to the opposite end. Every time a station is received, the receiver stops scanning. To continue scanning, press the button again.

Presetting Radio Stations

You'll most likely want to preset the receiver with the radio stations you listen to often so that you don't have to tune in the station every time. The receiver can store a total of 30 FM or AM stations. You can store the stations on preset numbers combining 3 characters (A, B, C) and numbers (0 - 9). For example, you can store a station as preset number A1, B6 or C9, etc.

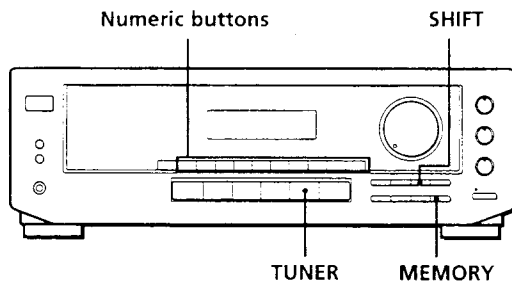

- 1 Press TUNER.
The last received station is tuned in.
- 2 Tune in the station you want.
If you are not familiar with how to tune in a station, see "Receiving Broadcasts" on the previous page.
- 3 Press MEMORY.
"MEMORY" appears for a few seconds.
Do steps 4 and 5 before "MEMORY" goes out.
- 4 Press SHIFT to select a character (A, B or C).
Each time you press SHIFT, the letter "A," "B" or "C" appears in the display.
If "MEMORY" disappears, start again from step 3.
- 5 While MEMORY is displayed, press the number you want to use (0 to 9).
- 6 Repeat Steps 2 to 5 to preset other stations.

To change a preset station

Preset a new station on the number you want to change.

Note

If the AC power cord is disconnected for about one week, the preset stations will be cleared from the receiver's memory, and you will have to preset the stations again.

Tuning preset stations (preset tuning)

You can tune directly to a preset station by entering its preset number. If you don't know which stations are preset on which numbers, you can tune by scanning the preset stations.

- 1 Press TUNER.
The last received station is tuned in.
- 2 Press SHIFT to select a character (A, B or C), then press the number.
For example, select A and then press 7 to tune in the station preset as A7.

💡 You can tune by scanning the preset stations

First press TUNER and then press PRESET TUNING + or - to select the station you want. Each time you press the buttons, the preset numbers change as follows:

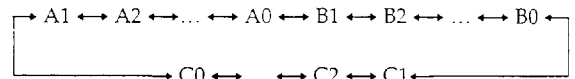

Recording

This receiver makes it easy to record to and from the components connected to the receiver. You don't have to connect playback and recording components directly: once you select a program source off the receiver, you can record and edit as you normally would using the controls on each component. Before you begin, make sure you've connected all components properly.

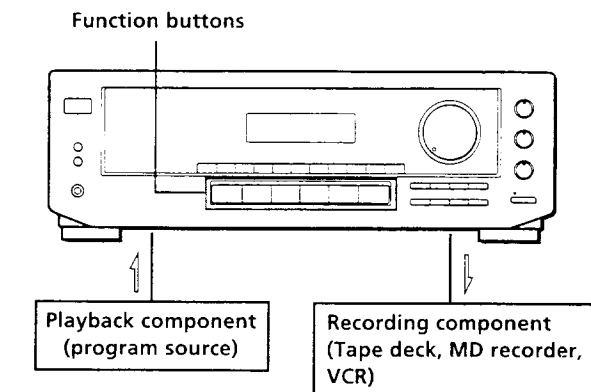

⚡: Audio signal flow

Recording on an audio tape, MiniDisc or video tape

You can record audio on a cassette tape, MiniDisc or video tape using the receiver. See the instruction manual of your tape deck, MD recorder or VCR if you need help.

- 1 Press one of the function buttons to select the program source.
- 2 Set the component to be ready for playing. For example, insert a CD into the CD player.
- 3 Insert a blank tape or disc into the recording deck and adjust the recording level, if necessary.
- 4 Start recording on the recording deck and then start playing the component.

Troubleshooting

If you experience any of the following difficulties while using the receiver, use this troubleshooting guide to help you remedy the problem. Should any problem persist, consult your nearest Sony dealer.

There's no sound or only a very low-level sound is heard.

- ➔ Check that the speakers and components are connected securely.
- ➔ Make sure you select the correct component on the receiver.
- ➔ Make sure you set the SPEAKERS selector correctly.
- ➔ Press MUTING on the remote if the MUTING indicator turns on.
- ➔ The protective device on the receiver has been activated because of a short circuit. ("PROTECT" flashes.) Turn off the receiver, eliminate the short-circuit problem and turn on the power again.

The left and right sounds are unbalanced or reversed.

- ➔ Check that the speakers and components are connected correctly and securely.
- ➔ Adjust the BALANCE control.

Severe hum or noise is heard.

- ➔ Check that the speakers and components are connected securely.
- ➔ Check that the connecting cords are away from a transformer or motor, and at least 10 feet (3 meters) away from a TV set or fluorescent light.
- ➔ Place your TV away from the audio components.
- ➔ Make sure you connect a ground wire to the antenna ground terminal.
- ➔ The plugs and jacks are dirty. Wipe them with a cloth slightly moistened with alcohol.

Radio stations cannot be tuned in.

- ➔ Check that the antennas are connected securely. Adjust the antennas and connect an outdoor antenna if necessary.
- ➔ The signal strength of the stations is too weak (when you tune in with automatic tuning). Use direct tuning.
- ➔ Make sure you set the tuning interval correctly (when you tune in AM stations with automatic tuning) (see pages 9 and 13).
- ➔ No stations have been preset or the preset stations have been cleared (when you tune in with scanning preset stations). Preset the stations (see page 10).

No picture or an unclear picture is seen on the TV screen.

- ➔ Place your TV away from the audio components.

Recording cannot be made.

- ➔ Check that the components are connected correctly.

The remote does not function.

- ➔ Point the remote at the remote sensor  on the receiver.
- ➔ Remove the obstacles in the path of the remote and the receiver.
- ➔ Replace both batteries in the remote with new ones if they are weak.
- ➔ Make sure you select the correct function on the remote.

Specifications

Audio power specifications

POWER OUTPUT AND TOTAL HARMONIC DISTORTION

With 8-ohm load, both channels driven, from 20 - 20,000 Hz, rated 100 watts per channel minimum RMS power, with no more than 0.1 % total harmonic distortion from 250 milliwatts to rated output.

Amplifier section

Dynamic power output USA model:
8 ohms: 150 W + 150 W
4 ohms: 210 W + 210 W
Canadian model:
8 ohms: 140 W + 140 W
4 ohms: 180 W + 180 W

Frequency response PHONO: RIAA equalization curve ± 0.5 dB
CD, TAPE/MD, VIDEO: 10 Hz - 50 kHz ± 1 dB

Inputs

	Sensitivity	Impedance	S/N (weighting network, input level)
PHONO (MM)	2.5 mV	50 kilohms	74 dB 72 dB* (A, 2.5 mV)
CD	200 mV		
TAPE/MD, TV, VIDEO	150 mV	50 kilohms	82 dB 82 dB* (A, 150 mV)

* -78 IHF

Outputs TAPE/MD REC OUT: Voltage 150 mV, Impedance 10 kilohms
VIDEO AUDIO OUT: Voltage 150 mV, Impedance 10 kilohms
PHONES: Accepts low and high impedance headphones

Muting Full mute

BASS BOOST +10 dB at 70 Hz

TONE ± 8 dB at 100 Hz and 10 kHz

FM tuner section

Tuning range 87.5 - 108.0 MHz

Antenna terminals 75 ohms, unbalanced
300 ohms, unbalanced

Sensitivity Mono: 18.3 dBf, 4.5 μ V
Stereo: 38.3 dBf, 45 μ V

Usable sensitivity 11.2 dBf, 2 μ V (IHF)

S/N Mono: 76 dB
Stereo: 70 dB

Harmonic distortion at 1 kHz Mono: 0.3 %
Stereo: 0.5 %

Separation 45 dB at 1 kHz ^{-0.5}/₋₂

Frequency response 30 Hz - 15 kHz dB

Selectivity 60 dB at 400 kHz

AM tuner section

Tuning range With 10 kHz interval**: 530 - 1710 kHz
With 9 kHz interval: 531 - 1710 kHz

Antenna Loop antenna

Usable sensitivity 50 dB/m (at 1,000 kHz or 999 kHz)

S/N 54 dB (at 50 mV/m)

Harmonic distortion 0.5 % (50 mV/m, 400 Hz)

Selectivity At 9 kHz: 35 dB
At 10 kHz: 40 dB

** You can change the AM tuning interval to 9 kHz. After tuning in any AM station, turn off the receiver. Hold down the TUNING + button and press the POWER button. All preset stations will be erased when you change the interval. To reset the interval to 10 kHz, repeat the procedure.

General

System Tuner section: PLL quartz-locked digital synthesizer system
Preamplifier section: Low-noise NF type equalizer
Power amplifier section: Pure-complimentary SEPP

Power requirements 120 V AC, 60 Hz

Power consumption USA model: 175 W
Canadian model: 270 VA

AC outlets 1 switched, total 120 W/1A Max

Dimensions 17 x 5 ³/₄ x 11 ⁵/₈ inches
(430 x 145 x 295 mm)

Mass (Approx.) 7.0 kg (15 lb 6 oz)

Supplied accessories FM wire antenna (1)
AM loop antenna (1)
Remote controller (remote) (1)
Size AA (R6) batteries (2)

Design and specifications are subject to change without notice.

A, B

- Adjusting
 - tone 8
 - volume 8
- Antenna hookups 5
- Audio/video component hookups 5, 6
- Automatic tuning 9

C

- Connecting. *See* Hookups

D

- Direct tuning 9
- Dubbing. *See* Recording

E, F, G

- Editing. *See* Recording

H, I, J, K, L, M, N, O

- Hookups
 - AC power cord 7
 - antennas 5
 - audio/video components 5, 6
 - overview 4
 - speakers 6, 7

P

- Presetting
 - radio stations 10
- Preset tuning 10
- Program source selecting 8

Q

- Quick reference guide
 - Back cover

R

- Rear panel 5, 6, 7, 14
- Receiving broadcasts
 - directly 9
 - using preset stations 10
- Recording
 - on a tape, MiniDisc or video tape 11
- Remote buttons 8, 15

S

- Scanning
 - preset stations 10
 - radio stations 9
- Selecting a program source 8
- Speakers
 - connection 6, 7
 - impedance 13
 - selecting speaker system 7
- Storing radio stations. *See* Presetting

T

- Troubleshooting 12
- Tuning. *See* Receiving broadcasts

U, V, W, X, Y, Z

- Unpacking 4

Rear Panel Descriptions

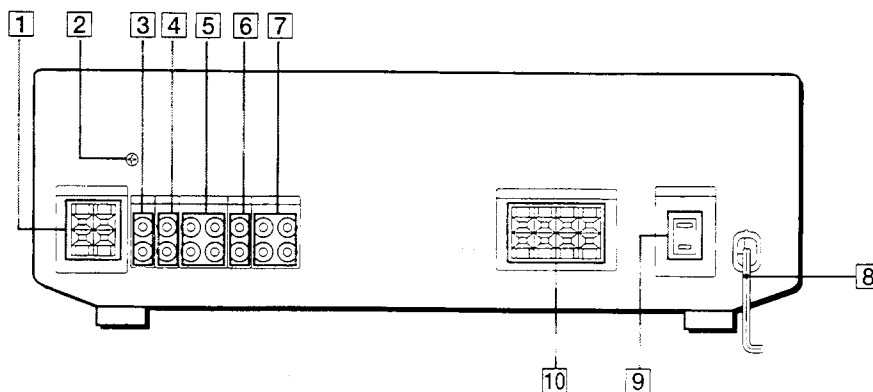

- 1 ANTENNA (AM/FM)
- 2 \perp ground terminal
- 3 PHONO
- 4 CD

- 5 TAPE/MD
- 6 TV
- 7 VIDEO

- 8 AC power cord
- 9 SWITCHED AC OUTLET
- 10 FRONT SPEAKERS (A/B)

Remote Button Descriptions

For buttons not described on previous pages and buttons with names different from the buttons on the main unit.

Remote Button	Operates	Function
PRESET +/-	Receiver	Scans and selects preset stations.
D. SKIP	CD player	Skips discs (CD player with multi-disc changer only.)
⏮/⏭	Tape deck	Fastforwards or rewinds.
⏪/⏩	CD player/ MD recorder	Skips tracks.
⏸	CD player/MD recorder	Pauses play or record. (Also starts recording with components in record standby.)
▶	CD player/ Tape deck/MD recorder	Starts play.
■	CD player/ Tape deck/MD recorder	Stops play.
◀	Tape deck	Starts play on the reverse side.

Receiving Broadcasts (direct tuning)

Example: Receiving FM
102.50 MHz

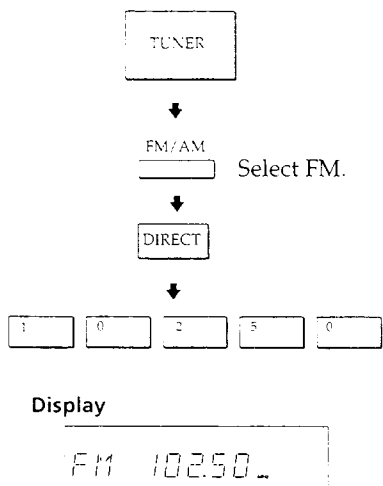

Presetting Radio Stations

Example: Presetting a
station as A7

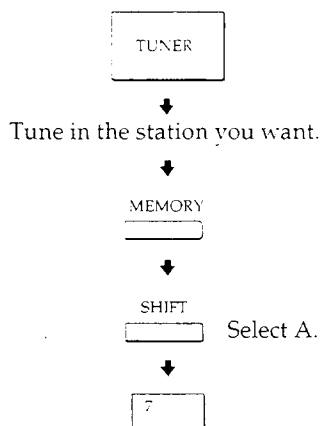

Selecting a Component

Example: Playing a CD

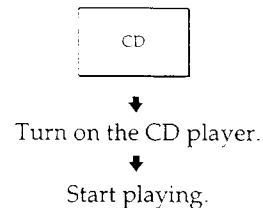

Scanning Radio Stations (automatic tuning)

Example: Scanning FM
stations

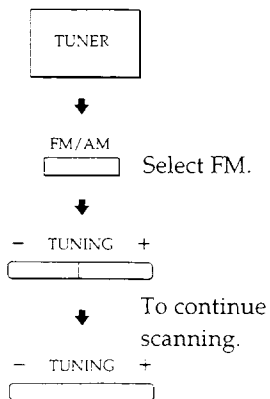

Receiving Preset Stations

Example: Receiving the
station number A7

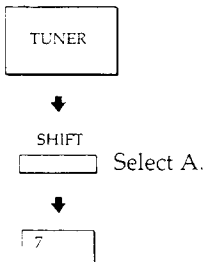

Scanning Preset Stations

