

# ***FM Stereo FM-AM Receiver***

---

Operating Instructions

*STR-DE545  
STR-DE445  
STR-SE501*

# WARNING

**To prevent fire or shock hazard, do not expose the unit to rain or moisture.**

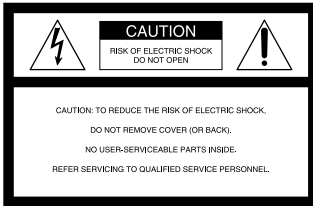

This symbol is intended to alert the user to the presence of uninsulated “dangerous voltage” within the product’s enclosure that may be of sufficient magnitude to constitute a risk of electric shock to persons.



This symbol is intended to alert the user to the presence of important operating and maintenance (servicing) instructions in the literature accompanying the appliance.

## INFORMATION

This equipment has been tested and found to comply with the limits for a Class B digital device, pursuant to Part 15 of the FCC Rules.

These limits are designed to provide reasonable protection against harmful interference in a residential installation. This equipment generates, uses, and can radiate radio frequency energy and, if not installed and used in accordance with the instructions, may cause harmful interference to radio communications. However, there is no guarantee that interference will not occur in a particular installation. If this equipment does cause harmful interference to radio or television reception, which can be determined by turning the equipment off and on, the user is encouraged to try to correct the interference by one or more of the following measures:

- Reorient or relocate the receiving antenna.
- Increase the separation between the equipment and receiver.
- Connect the equipment into an outlet on a circuit different from that to which the receiver is connected.
- Consult the dealer or an experienced radio/TV technician for help.

## CAUTION

You are cautioned that any changes or modification not expressly approved in this manual could void your authority to operate this equipment.

### Note to CATV system installer:

This reminder is provided to call CATV system installer’s attention to Article 820-40 of the NEC that provides guidelines for proper grounding and, in particular, specifies that the cable ground shall be connected to the grounding system of the building, as close to the point of cable entry as practical.



ENERGY STAR® is a U.S. registered mark. As an ENERGY STAR® partner, Sony Corporation has determined that this product meets the ENERGY STAR® guidelines for energy efficiency.

## Owner’s Record

The model and serial numbers are located on the rear of the unit. Record the serial number in the space provided below. Refer to them whenever you call upon your Sony dealer regarding this product.

Model No. STR-DE545/DE445/SE501  
Serial No. \_\_\_\_\_

# Precautions

## On safety

Should any solid object or liquid fall into the cabinet, unplug the receiver and have it checked by qualified personnel before operating it any further.

## On power sources

- Before operating the receiver, check that the operating voltage is identical with your local power supply. The operating voltage is indicated on the nameplate at the rear of the receiver.
- The unit is not disconnected from the AC power source (mains) as long as it is connected to the wall outlet, even if the unit itself has been turned off.
- If you are not going to use the receiver for a long time, be sure to disconnect the receiver from the wall outlet. To disconnect the AC power cord, grasp the plug itself; never pull the cord.
- One blade of the plug is wider than the other for the purpose of safety and will fit into the wall outlet only one way. If you are unable to insert the plug fully into the outlet, contact your dealer.
- AC power cord must be changed only at the qualified service shop.

## On placement

- Place the receiver in a location with adequate ventilation to prevent heat buildup and prolong the life of the receiver.
- Do not place the receiver near heat sources, or in a place subject to direct sunlight, excessive dust or mechanical shock.
- Do not place anything on top of the cabinet that might block the ventilation holes and cause malfunctions.

## On operation

Before connecting other components, be sure to turn off and unplug the receiver.

## On cleaning

Clean the cabinet, panel and controls with a soft cloth slightly moistened with a mild detergent solution. Do not use any type of abrasive pad, scouring powder or solvent such as alcohol or benzine.

If you have any question or problem concerning your receiver, please consult your nearest Sony dealer.

## About This Manual

The instructions in this manual are for the STR-DE545, STR-DE445 and STR-SE501. Check your model number by looking at the upper right corner of the front panel or lower right corner of the remote. In this manual, the STR-DE545 and the remote commander RM-U304 are used for illustration purposes unless stated otherwise. Any difference in operation is clearly indicated in the text, for example, "STR-DE545 only".

### Type of differences

Model	DE545	DE445	SE501
CONTROL A1-II	●		●
SPEAKERS FRONT B	●		●
S-Video	●		●
TV/SAT OPTICAL IN	●		●
AC OUTLET	●		●
IMPEDANCE SELECTOR	●		●

### Conventions

- The instructions in this manual describe the controls on the receiver. You can also use the controls on the supplied remote if they have the same or similar names as those on the receiver. For details on the use of the remote RM-PP404 (STR-DE545 and STR-SE501 only), refer to the separate operating instructions supplied with the remote.
- The following icon is used in this manual:  
 Indicates hints and tips for making the task easier.

This receiver incorporates Dolby\* Digital and Pro Logic Surround and the DTS\*\* Digital Surround System.

\* Manufactured under license from Dolby Laboratories. "Dolby", "AC-3", "Pro Logic" and the double-D symbol  are trademarks of Dolby Laboratories.

\*\*Manufactured under license from Digital Theater Systems, Inc. US Pat. No. 5,451,942 and other worldwide patents issued and pending. "DTS" and "DTS Digital Surround" are trademarks of Digital Theater Systems, Inc. © 1996 Digital Theater Systems, Inc. All rights reserved.

### Demonstration Mode

The demonstration will activate the first time you turn on the power. When the demonstration starts, the following message appears in the display:

"NOW DEMONSTRATION MODE IF YOU FINISH DEMONSTRATION PLEASE PRESS POWER KEY WHILE THIS MESSAGE APPEARS IN THE DISPLAY THANK YOU"

### To cancel the demonstration

Press I/⏻ to turn the receiver off while the above message is being displayed. The next time you turn the receiver on, the demonstration will not appear.

### To view the demonstration

Hold down SET UP and press I/⏻ to turn on the power.

### Notes

- Running the demonstration will clear the receiver's memory. For details on what will be cleared, see "Clearing the receiver's memory" on page 15.
- There will be no sound when the demonstration mode is activated.

# TABLE OF CONTENTS

## Hooking Up the Components 4

Unpacking	4
Antenna Hookups	5
Audio Component Hookups	6
Video Component Hookups	7
Digital Component Hookups	8
5.1CH Input Hookups	9
Other Hookups	10

## Hooking Up and Setting Up the Speaker System 12

Speaker System Hookup	13
Performing Initial Setup Operations	15
Multi Channel Surround Setup	16
Before You Use Your Receiver	20

## Location of Parts and Basic Operations 22

Front Panel Parts Descriptions	22
--------------------------------	----

## Enjoying Surround Sound 27

Selecting a Sound Field	28
Understanding the Multi-Channel Surround Displays	31
Customizing Sound Fields	33

## Receiving Broadcasts 37

Direct Tuning	39
Automatic Tuning	39
Preset Tuning	40

## Other Operations 41

Naming Preset Stations and Program Sources	42
Recording	42
Using the Sleep Timer	43
Adjustment Using the SET UP Button	44

## Additional Information 45

Troubleshooting	45
Specifications	47
Glossary	49
Settings Using SUR, LEVEL, BASS/TREBLE, and SET UP buttons	50
Remote Button Descriptions (STR-DE445 only)	51
Index	54

# Hooking Up the Components

This chapter describes how to connect various audio and video components to the receiver. Be sure to read the sections for the components you have before you actually connect them to the receiver.

## Unpacking

Check that you received the following items with the receiver:

- FM wire antenna (1)
- AM loop antenna (1)
- R6 (size-AA) batteries (2)
- STR-DE545 and STR-SE501 only
  - Remote Commander RM-PP404 (remote) (1)
  - Operating instructions of the remote (1)
  - Operating instructions of CONTROL A1 II (1)
- STR-DE445 only
  - Remote Commander RM-U304 (remote) (1)

### Inserting batteries into the remote

Insert R6 (size-AA) batteries with the + and – properly oriented in the battery compartment. When using the remote, point it at the remote sensor  on the receiver.

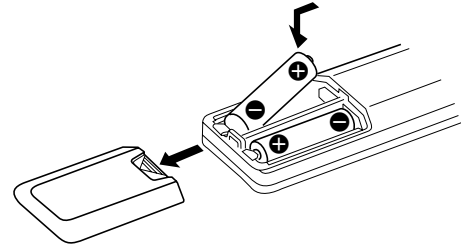

For details, refer to the operating instructions supplied with your remote (STR-DE545 and STR-SE501 only).



### When to replace batteries

Under normal conditions, the batteries should last for about 6 months. When the remote no longer operates the receiver, replace all batteries with new ones.

### Notes

- Do not leave the remote in an extremely hot or humid place.
- Do not use a new battery with an old one.
- Do not expose the remote sensor to direct sunlight or lighting apparatuses. Doing so may cause a malfunction.
- If you don't use the remote for an extended period of time, remove the batteries to avoid possible damage from battery leakage and corrosion.

### Before you get started

- Turn off the power to all components before making any connections.
- Do not connect the AC power cords until all of the connections are completed.
- Be sure to make connections firmly to avoid hum and noise.
- When connecting an audio/video cord, be sure to match the color-coded pins to the appropriate jacks on the components: yellow (video) to yellow; white (left, audio) to white; and red (right, audio) to red.

# Antenna Hookups

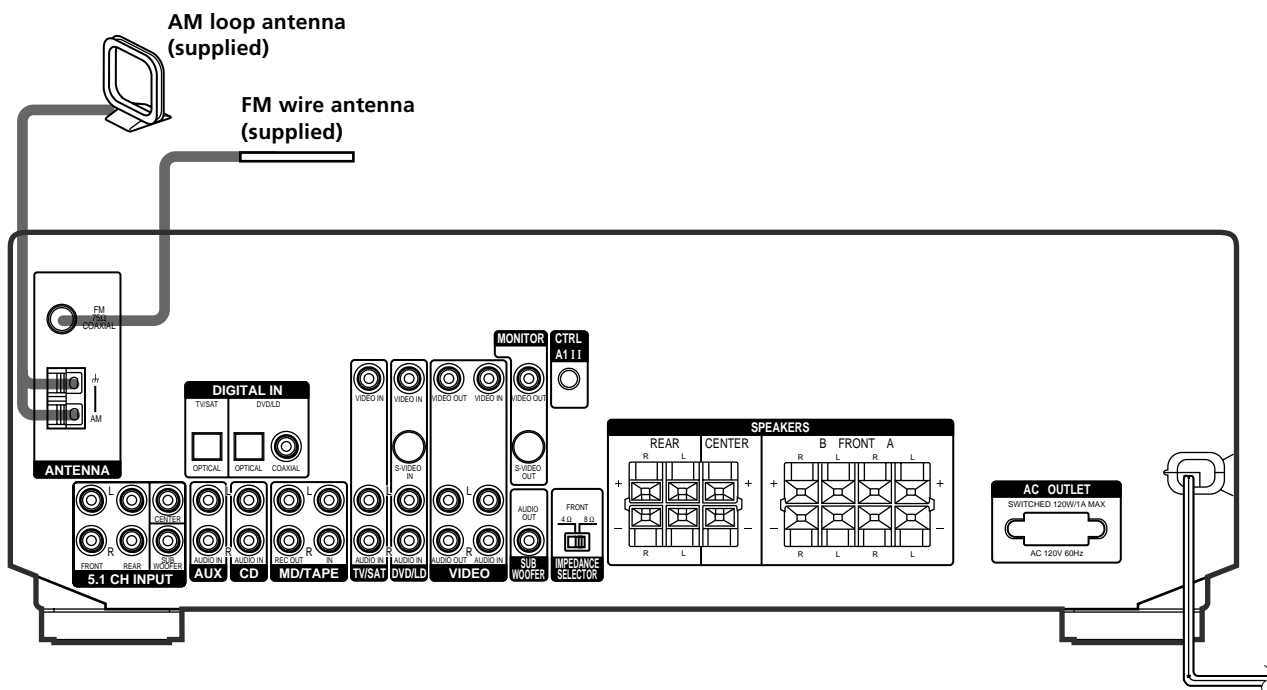

## Terminals for connecting the antennas

Connect the	To the
AM loop antenna	AM terminals
FM wire antenna	FM 75Ω COAXIAL terminal

## Notes on antenna hookups

- To prevent noise pickup, keep the AM loop antenna away from the receiver and other components.
- Be sure to fully extend the FM wire antenna.
- After connecting the FM wire antenna, keep it as horizontal as possible.

### 💡 If you have poor FM reception

Use a 75-ohm coaxial cable (not supplied) to connect the receiver to an outdoor FM antenna as shown below.

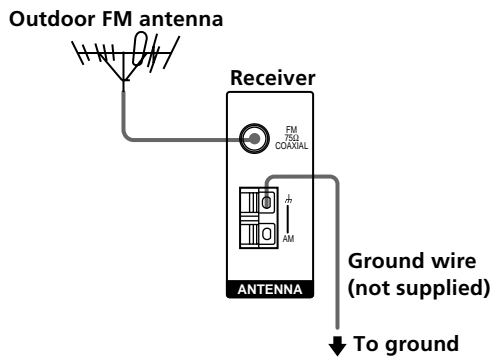

### Important

If you connect the receiver to an outdoor antenna, ground it against lightning. To prevent a gas explosion, do not connect the ground wire to a gas pipe.

# Audio Component Hookups

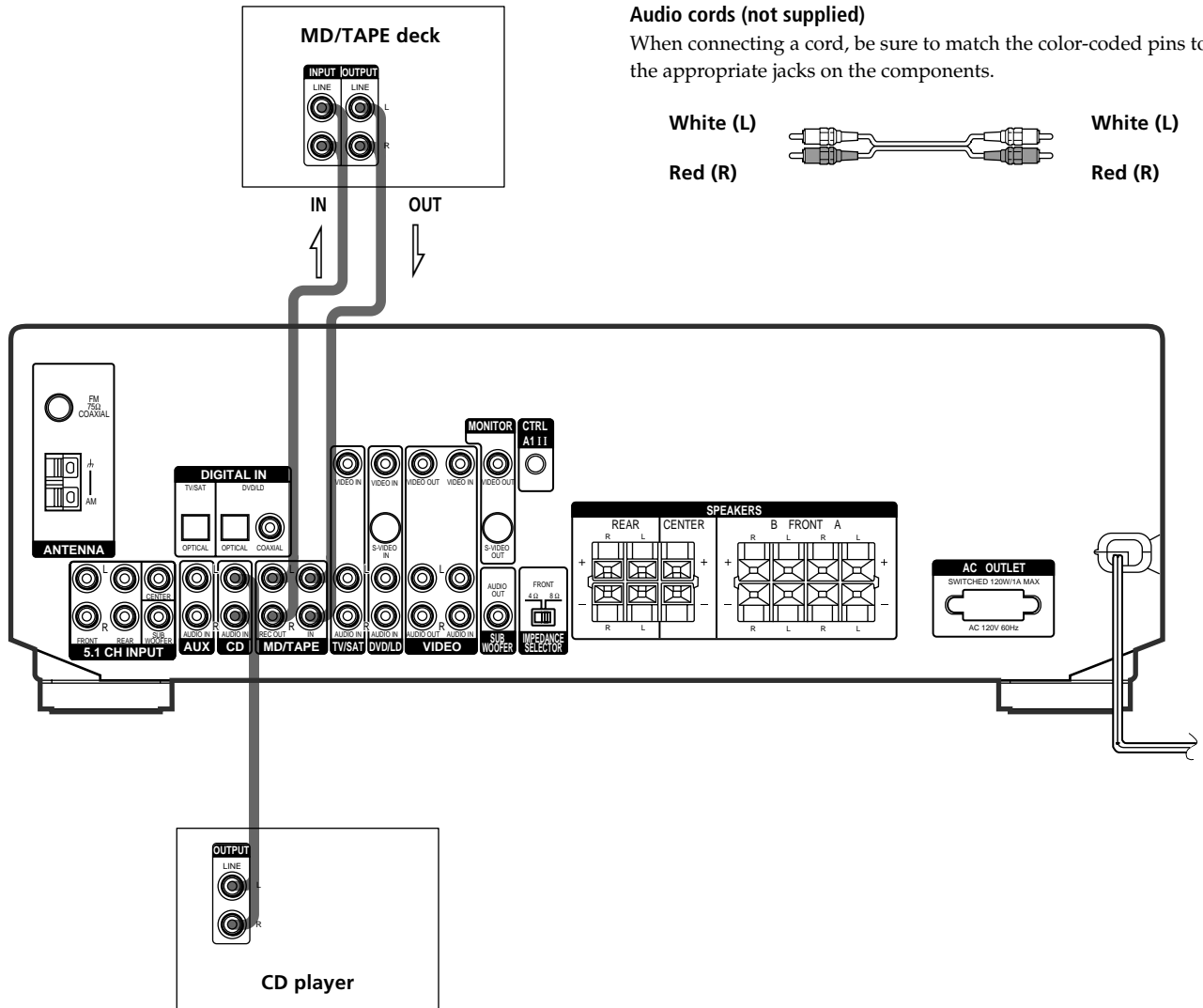

## Jacks for connecting audio components

Connect a	To the
CD player	CD jacks
MD deck or Tape deck	MD/TAPE jacks

# Video Component Hookups

## Required cords

### Audio/video cords (not supplied)

When connecting a cord, be sure to match the color-coded pins to the appropriate jacks on the components.

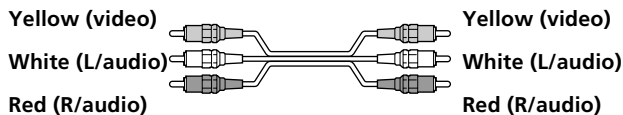

### Video cord for connecting a TV monitor (not supplied)

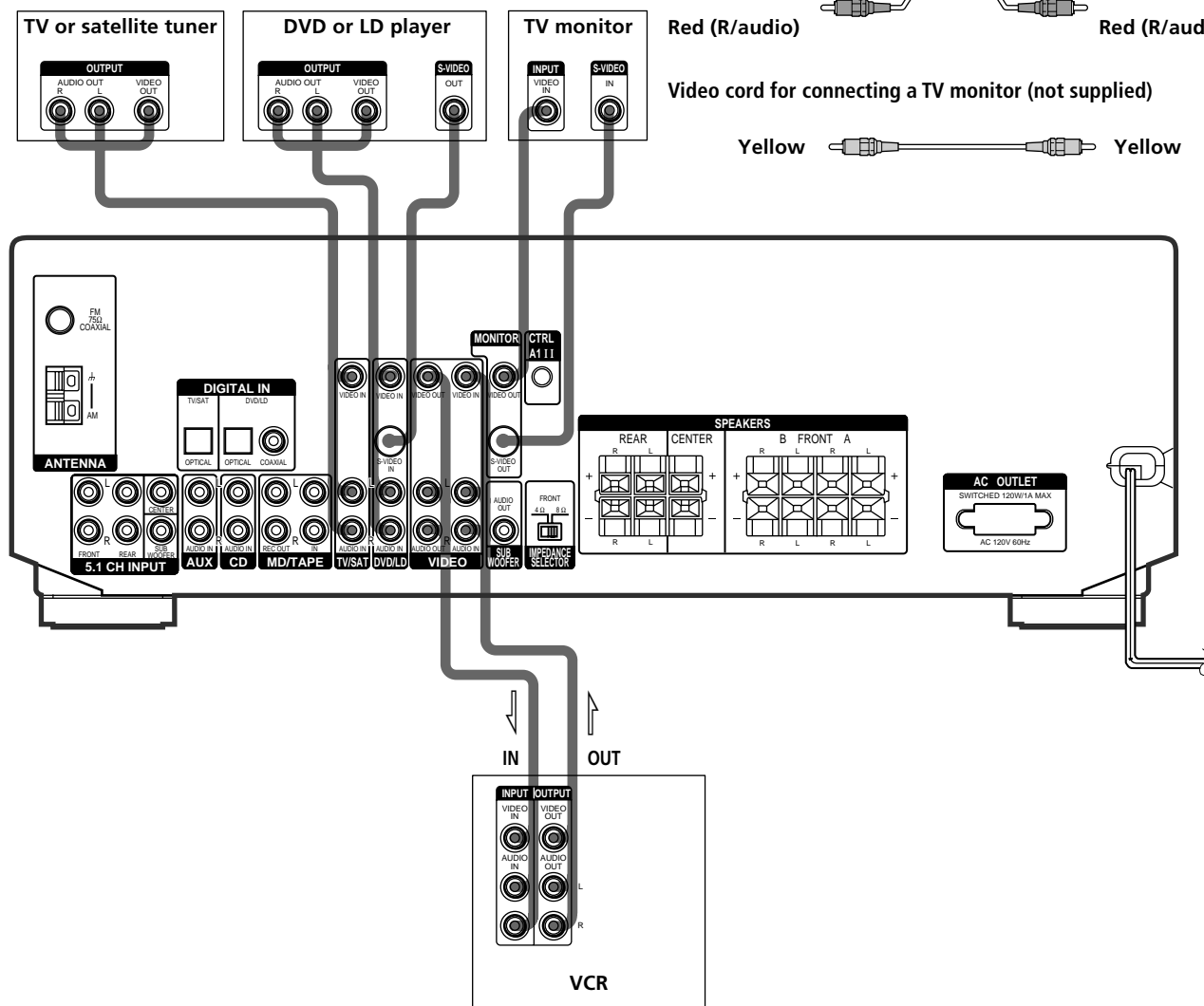

## Jacks for connecting video components

Connect a	To the
TV or satellite tuner	TV/SAT jacks
VCR	VIDEO jacks
DVD or LD player	DVD/LD jacks
TV monitor	MONITOR VIDEO OUT jack

## Note on video component hookups

You can connect your TV's audio output jacks to the TV/SAT AUDIO IN jacks on the receiver and apply sound effects to the audio from the TV. In this case, do not connect the TV's video output jack to the TV/SAT VIDEO IN jack on the receiver. If you are connecting a separate TV tuner (or satellite tuner), connect both the audio and video output jacks to the receiver as shown above.

**💡 When using the S-video jacks instead of the video jacks (STR-DE545 and STR-SE501 only)**

Your monitor must also be connected via an S-video jack. S-video signals are on a separate bus from the video signals and will not be output through the video jacks.

# Digital Component Hookups

Connect the digital output jacks of your DVD player and satellite tuner (etc.) to the receiver's digital input jacks to bring the multi channel surround sound of a movie theater into your home. To enjoy full effect of multi channel surround sound, five speakers (two front speakers, two rear speakers, and a center speaker) and a sub woofer are required. You can also connect an LD player with an RF OUT jack via an RF demodulator, such as the Sony MOD-RF1 (not supplied).

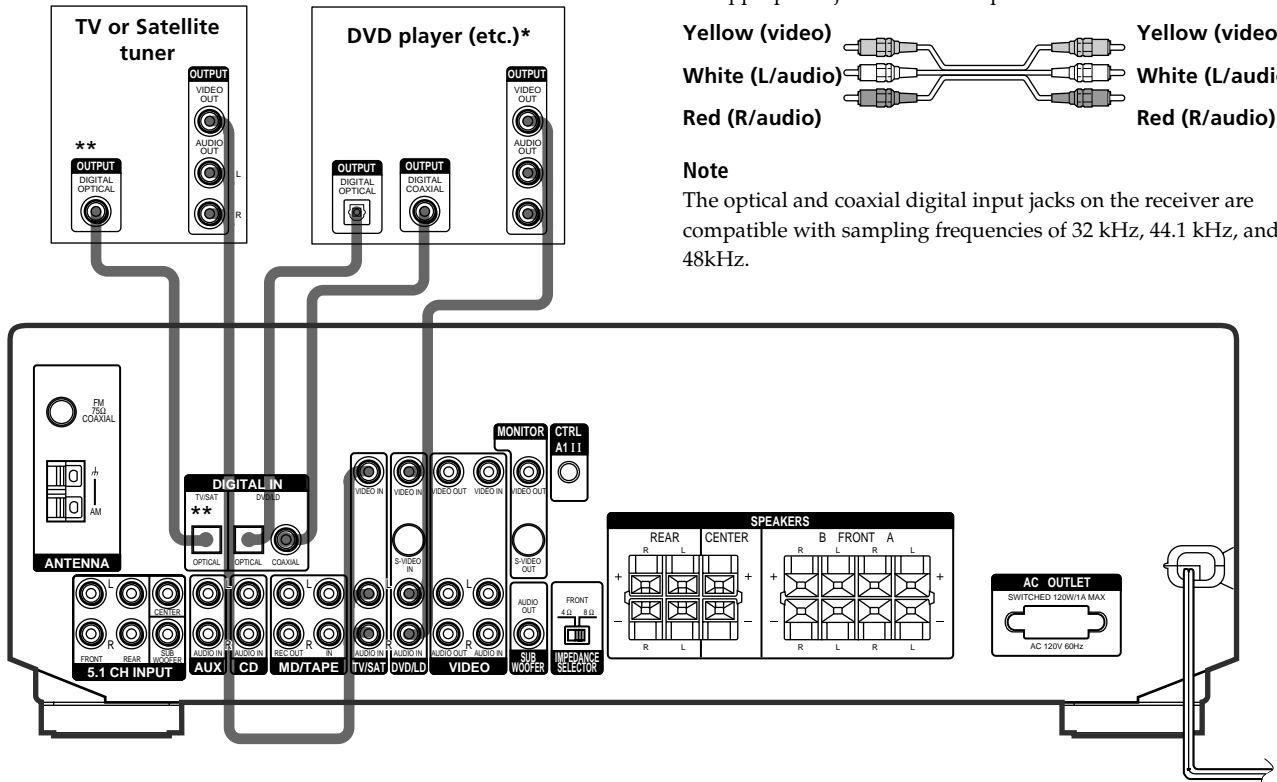

\* When making digital audio connections to a DVD player, connect to either the coaxial OR optical digital jacks, and not both. It is recommended to make digital audio connections to the coaxial jack.

\*\* STR-DE545 and STR-SE501 only.

## Example of LD player connected via an RF demodulator

Please note that you cannot connect an LD player's AC-3 RF OUT jack directly to the receiver's digital input jacks. You must first convert the RF signal to either an optical or coaxial digital signal. Connect the LD player to the RF demodulator, then connect the RF demodulator's optical or coaxial digital output to the receiver's OPTICAL or COAXIAL DVD/LD IN jack. Refer to the instruction manual supplied with your RF Demodulator for details on AC-3 RF hookups.

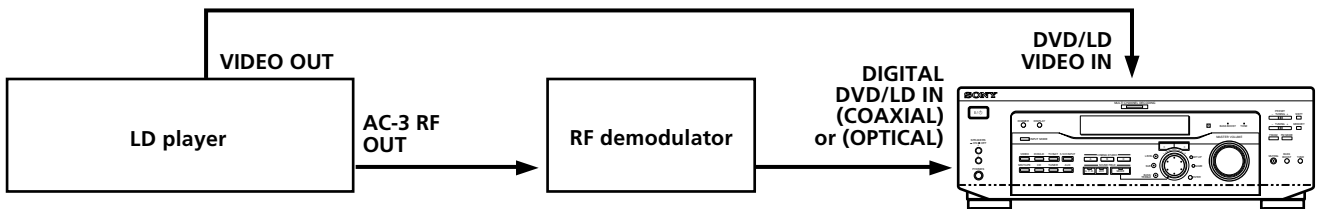

**Note**

When making connections as shown above, be sure to set INPUT MODE (3) on page 23) manually. The receiver may not operate correctly if INPUT MODE is set to "AUTO."

## Required cords

Optical digital cords (not supplied)

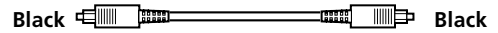

Coaxial digital cord (not supplied)

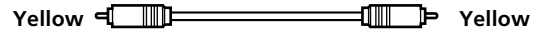

Audio/video cords (not supplied)

When connecting a cord, be sure to match the color-coded pins to the appropriate jacks on the components.

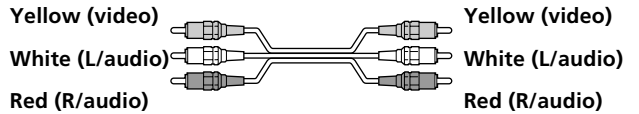

**Note**

The optical and coaxial digital input jacks on the receiver are compatible with sampling frequencies of 32 kHz, 44.1 kHz, and 48kHz.



## 5.1CH Input Hookups

Although this receiver incorporates a multi channel decoder, it is also equipped with 5.1CH INPUT jacks. These connections allow you to enjoy multichannel software encoded in formats other than Dolby Digital (AC-3) and DTS. If your DVD player is equipped with 5.1CH OUTPUT jacks, you can connect them directly to the receiver to enjoy the sound of the DVD player's multi channel decoder. Alternatively, the 5.1CH INPUT jacks can be used to connect an external multi channel decoder. To fully enjoy multi channel surround sound, you will need five speakers (two front speakers, two rear speakers, and a center speaker) and a sub woofer. Refer to the instruction manual supplied with your DVD player, multi channel decoder, etc., for details on the 5.1 channel input hookups.

### Required cords

#### Audio cords (not supplied)

Two for the 5.1CH INPUT FRONT and REAR jacks

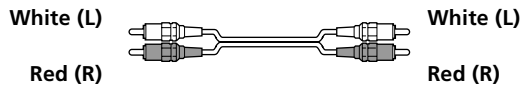

#### Monaural audio cords (not supplied)

Two for the 5.1CH INPUT CENTER and WOOFER jacks

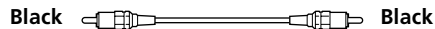

#### Video cord (not supplied)

One for the DVD/LD VIDEO IN jacks (etc.)



#### Note

When using the connections described below, adjust the level of your surround speakers and sub woofer from the DVD player or multichannel decoder.

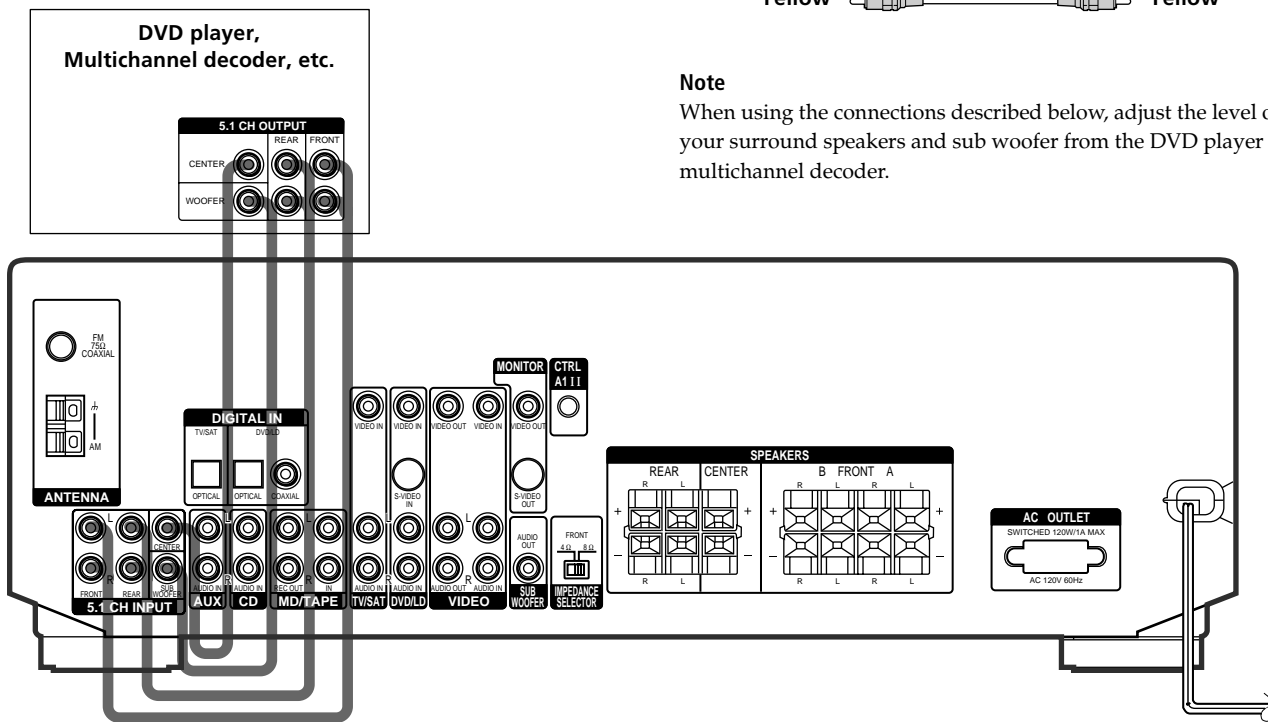

### Example of a DVD player hookup using the 5.1 INPUT jacks

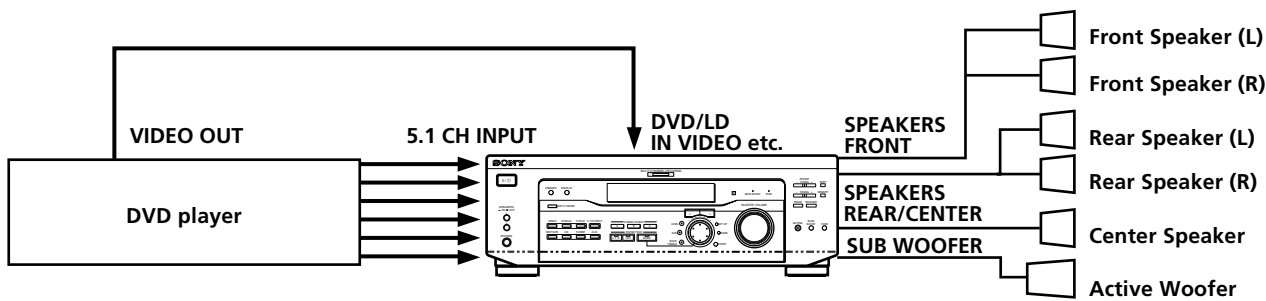

#### Note

See page 13 for details on speaker system hookup.



### CONTROL A1 II hookup (STR-DE545 and STR-SE501 only)

- **If you have a CONTROL A1 II compatible Sony CD player, tape deck, or MD deck**

Use a CONTROL A1 cord (not supplied) to connect the CONTROL A1 II jack on the CD player, tape deck, or MD deck to the CONTROL A1 II jack on the receiver. Refer to the separate manual "CONTROL-A1 II Control System" and the operating instructions supplied with your CD player, tape deck, or MD deck for details.

**Note**

If you make CONTROL A1 II connections from the receiver to an MD deck that is also connected to a computer, do not operate the receiver while using the "Sony MD Editor" software. This may cause a malfunction.

- **If you have a Sony CD changer with a COMMAND MODE selector**

If your CD changer's COMMAND MODE selector can be set to CD 1, CD 2, or CD 3, be sure to set the command mode to "CD 1" and connect the changer to the CD jacks on the receiver.

If, however, you have a Sony CD changer with VIDEO OUT jacks, set the command mode to "CD 2" and connect the changer to the VIDEO IN jacks on the receiver.

### AUX AUDIO IN hookup

- **If you have an individual audio component (except PHONO)**

Use the audio cords to connect the LINE OUT jacks on the CD player, tape deck, or MD deck to the AUX AUDIO IN jack on the receiver so that you can listen to stereo sources in surround sound.

### Connecting the AC power cord

Before connecting the AC power cord of this receiver to a wall outlet:

- Connect the speaker system to the receiver (see page 13).

Connect the AC power cord(s) of your audio/video components to a wall outlet.

#### STR-DE545 and STR-SE501 only

If you connect other audio/video components to the AC OUTLET(s) on the receiver, the receiver will supply power to the connected component(s), allowing you to turn the whole system on or off when you turn the receiver on or off.

**Caution**

Make sure that the total power consumption of the component(s) connected to the receiver's AC OUTLET(s) does not exceed the wattage stated on the rear panel. Do not connect high-wattage electrical home appliances such as electric irons, fans, or TVs to this outlet. (STR-DE545 and STR-SE501 only)

**Note**

If the AC power cord is disconnected for about two weeks, the receiver's entire memory will be cleared and the demonstration will start.

# Hooking Up and Setting Up the Speaker System

This chapter describes how to hook up your speaker system to the receiver, how to position each speaker, and how to set up your speakers to enjoy multi channel surround sound.

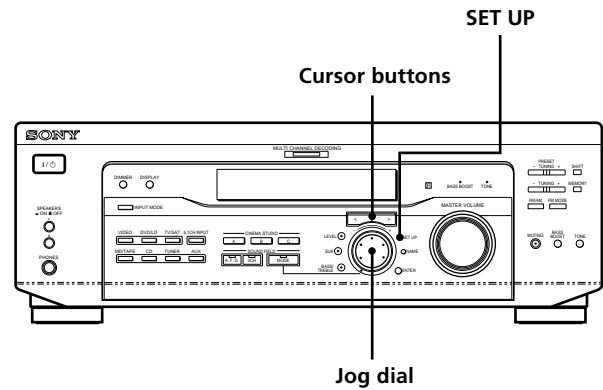

## Brief descriptions of buttons and control used to set up the speaker system

**SET UP button:** Press to enter the setup mode when specifying speaker types and distances.

**Cursor buttons (</>):** Use to select parameters after pressing the SET UP button.

**Jog dial:** Use to adjust the setting of each parameter.

# Speaker System Hookup

## Required cords

### Speaker cords (not supplied)

One for each front, rear, and center speaker



### Monaural audio cord (not supplied)

One for an active woofer

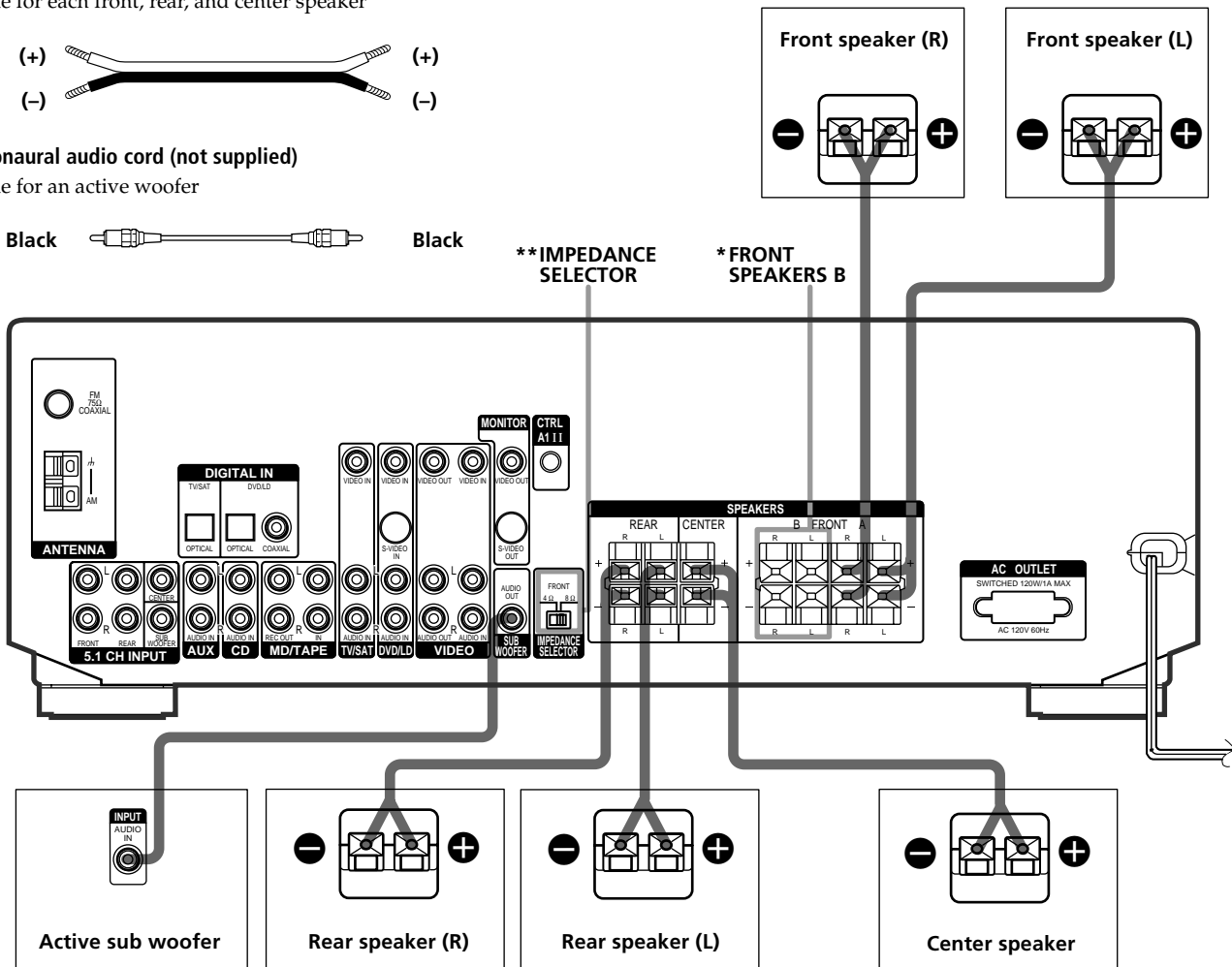

Hooking Up and Setting Up the Speaker System

## Terminals for connecting the speakers

Connect the	To the
Front speakers (8 or 4** ohm)	SPEAKERS FRONT A terminals
*Additional pair of front speakers (8 or 4** ohm)	SPEAKERS FRONT B terminals
Rear speakers (8 ohm)	SPEAKERS REAR terminals
Center speaker (8 ohm)	SPEAKERS CENTER terminals
Active sub woofer	SUB WOOFER AUDIO OUT jack

\* STR-DE545 and STR-SE501 only.

\*\* See "Speaker impedance" on the next page.

## Notes on speaker system hookup

- Twist the stripped ends of the speaker cords about 2/3 inch (10 mm). Be sure to match the speaker cord to the appropriate terminal on the components: + to + and - to -. If the cords are reversed, the sound will be distorted and will lack bass.
- If you use front speakers with low maximum input rating, adjust the volume carefully to avoid excessive output on the speakers.
- You can also connect Micro Satellite Speaker (e.g. SA-VE230) to the receiver. Micro Satellite Speaker is a 5.1 Channel speaker system consisting of two front speakers, two rear speakers, one center speaker and one subwoofer.

## Speaker System Hookup

### To avoid short-circuiting the speakers

Short-circuiting of the speakers may damage the receiver. To prevent this, make sure to take the following precautions when connecting the speakers.

**Make sure the stripped ends of each speaker cord does not touch another speaker terminal or the stripped end of another speaker cord.**

### Examples of poor conditions of the speaker cord

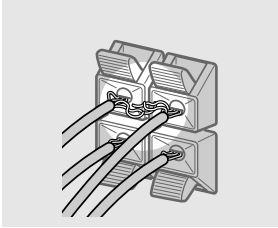

Stripped speaker cord is touching another speaker terminal.

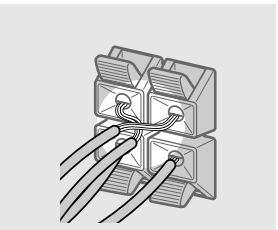

Stripped cords are touching each other due to excessive removal of insulation.

**After connecting all the components, speakers, and AC power cord, output a test tone to check that all the speakers are connected correctly. For details on outputting a test tone, see page 19.**

If no sound is heard from a speaker while outputting a test tone or a test tone is output from a speaker other than the one whose name is currently displayed on the receiver, the speaker may be short-circuited. If this happens, check the speaker connection again.

### To avoid damaging your speakers

Make sure that you turn down the volume before you turn off the receiver. When you turn on the receiver, the volume remains at the level you turn off the receiver.

### Speaker impedance (STR-DE545 and STR-SE501 only)

Set the IMPEDANCE SELECTOR for the front speakers as indicated in the table below. Check the instruction manual supplied with your speakers if you're not sure of their impedance. (This information is usually printed on a label on the back of the speaker.)

If the nominal impedance of your speaker is	Set IMPEDANCE SELECTOR to
Between 4 and 8 ohms	4Ω
8 ohms or higher	8Ω

Speakers connected to the REAR and CENTER SPEAKERS terminals must have a nominal impedance of 8 ohms or higher (regardless of the setting of the IMPEDANCE SELECTOR).

#### Note

Be sure to connect front speakers with a nominal impedance of 8 ohms or higher if you want to select both sets (A+B) of front speakers (see page 23).

## Performing Initial Setup Operations

Once you have hooked up the speakers and turned on the power, clear the receiver's memory. Then specify the speaker parameters (size, position, etc.) and perform any other initial setup operations necessary for your system.

### Before turning on the receiver

Make sure that you have:

- Selected the appropriate front speakers (see "[7] SPEAKERS selector" on page 23). (STR-DE545 and STR-SE501 only).

### Clearing the receiver's memory

Before you use your receiver for the first time or when you want to clear the receiver's memory, do the following. This procedure is not necessary if the demonstration activates when you turn the power on.

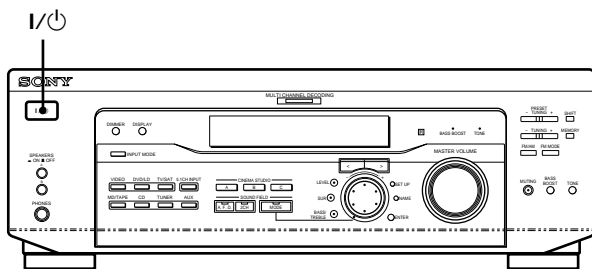

**1 Turn off the receiver.**

**2 Hold down I/⏻ for four seconds.**

The currently selected function, then the demonstration message appears in the display and the items including the following are reset or cleared:

- All preset stations are reset or cleared.
- All sound field parameters are reset to their factory settings.
- All index names (of preset stations and program sources) are cleared.
- All adjustments made with the SET UP button are reset to their factory settings.
- The sound field memorized for each program source and preset stations are cleared.

### Performing initial setup operations

Before you use your receiver for the first time, use the SET UP button to adjust settings to correspond to your system. You can set the following items. For details on how to adjust each setting, see the page in parentheses.

- Speaker size and placement (page 16).
- Speaker distance (page 18).
- The video signal paired with the 5.1CH INPUT (page 44).

# Multi Channel Surround Setup

For the best possible surround sound all speakers should be the same distance from the listening position (A). (However, this unit lets you to place the center speaker up to 5 feet (1.5 meters) closer (B) and the rear speakers up to 15 feet (4.5 meters) closer (C) to the listening position. The front speakers can be placed from 3 to 40 feet (1.0 to 12.0 meters) from the listening position (A).)

You can place the rear speakers either behind you or to the side, depending on the shape of your room (etc.).

When placing rear speakers to your side

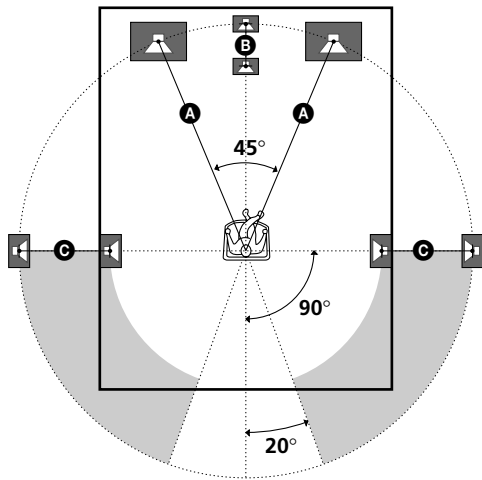

When placing the rear speakers behind you

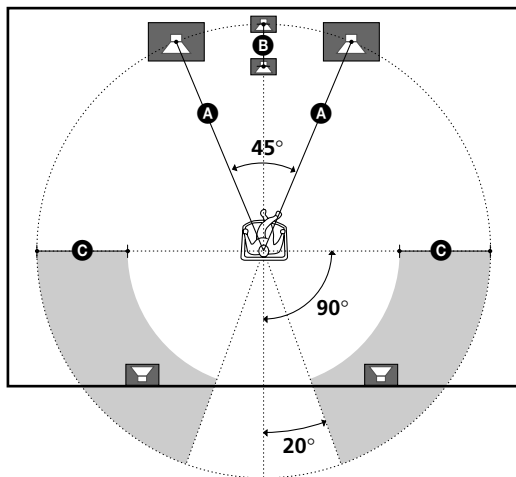

**Note**

Do not place the center speaker farther away from the listening position than the front speakers.

## Specifying the speaker parameters

- 1 Press I/⏻ to turn on the receiver.
- 2 Press SET UP.
- 3 Press the cursor buttons (< or >) to select the parameter you want to adjust.
- 4 Turn the jog dial to select the setting you want. The setting is stored automatically.
- 5 Repeat steps 3 and 4 until you have set all of the parameters that follow.

**💡 Normal speaker and Micro Satellite speaker**

Choose NORM. SP if you're using normal speakers and MICRO SP if you're using Micro Satellite speakers. If you choose NORM. SP, you can adjust the speaker size and the sub woofer selection as mentioned below. However, if you choose MICRO SP, the speaker size and the sub woofer selection has been configured as follows:

Speakers	Settings
Front	Small
Center	Small
Rear	Small
Woofer	Yes

You cannot change the configuration if you choose MICRO SP.

For STR-SE501, the speaker size and sub woofer selection has been preset to MICRO SP according to the supplied speaker system. If you change the speaker system, choose NORM. SP to adjust the speaker size and sub woofer selection.

**■ Front speaker size (L, R)**

Initial setting : LARGE (STR-DE545/DE445)  
SMALL (STR-SE501)

- If you connect large speakers that will effectively reproduce bass frequencies, select "LARGE". Normally, select "LARGE".
- If the sound is distorted, or you feel a lack of surround effects when using multi channel surround sound, select "SMALL" to activate the bass redirection circuitry and output the front channel bass frequencies from the sub woofer.
- When the front speaker is set to "SMALL", the center and rear speakers are also automatically set to "SMALL" (unless previously set to "NO").



### ■ Center speaker size ( )

Initial setting : LARGE (STR-DE545/DE445)  
SMALL (STR-SE501)

- If you connect a large speaker that will effectively reproduce bass frequencies, select "LARGE". Normally, select "LARGE". However, if the front speakers are set to "SMALL", you cannot set the center speaker to "LARGE".
- If the sound is distorted, or you feel a lack of surround effects when using multi channel surround sound, select "SMALL" to activate the bass redirection circuitry and output the center channel bass frequencies from the front speakers (if set to "LARGE") or sub woofer. \*<sup>1</sup>
- If you do not connect the center speaker, select "NO". The sound of the center channel will be output from the front speakers.\*<sup>2</sup>

### ■ Rear speaker size ( )

Initial setting : LARGE (STR-DE545/DE445)  
SMALL (STR-SE501)

- If you connect large speakers that will effectively reproduce bass frequencies, select "LARGE". Normally, select "LARGE". However, if the front speakers are set to "SMALL", you cannot set the rear speakers to "LARGE".
- If the sound is distorted, or you feel a lack of surround effects when using multi channel surround sound, select "SMALL" to activate the bass redirection circuitry and output the rear channel bass frequencies from the sub woofer or other "LARGE" speakers.
- If you do not connect rear speakers, select "NO".\*<sup>3</sup>

 \*1~\*3 correspond to the following Dolby Pro Logic modes

- \*<sup>1</sup> NORMAL
- \*<sup>2</sup> PHANTOM
- \*<sup>3</sup> 3 STEREO

### About speaker sizes (LARGE and SMALL)

Internally, the LARGE and SMALL settings for each speaker determine whether or not the internal sound processor will cut the bass signal from that channel. When the bass is cut from a channel the bass redirection circuitry sends the corresponding bass frequencies to the sub woofer or other "LARGE" speaker. However, since bass sounds have a certain amount of directionality it best not to cut them, if possible. Therefore, even when using small speakers, you can set them to "LARGE" if you want to output the bass frequencies from that speaker. On the other hand, if you are using a large speaker, but prefer not to have bass frequencies output from that speaker, set it to "SMALL".

If the overall sound level is lower than you prefer, set all speakers to "LARGE". If there is not enough bass, you can use the bass/treble to boost the bass levels. To adjust the bass/treble, see page 35.

### ■ Rear speaker position (REAR PL.)\*

Initial setting : BEHIND

This parameter lets you specify the location of your rear speakers for proper implementation of the Digital Cinema Sound surround modes in the "VIRTUAL" sound fields. Refer to the illustration below.

- Select "SIDE" if the location of your rear speakers corresponds to section **A**.
- Select "BEHIND" if the location of your rear speakers corresponds to section **B**.

This setting only effects the surround modes in the "VIRTUAL" sound fields.

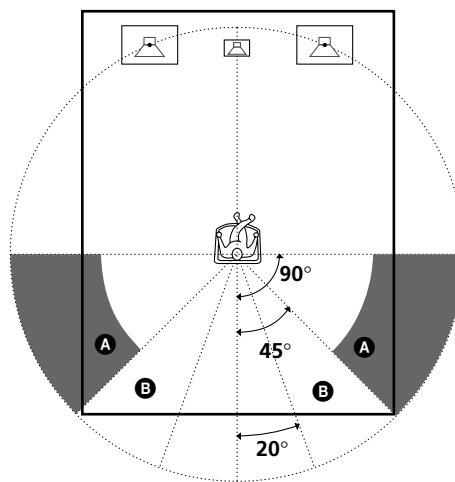

\* These parameters are not available when "Rear speaker size (REAR)" is set to "NO".

## Multi Channel Surround Setup

### ■ Rear speaker height (REAR HGT.)\*

Initial setting : LOW

This parameter lets you specify the height of your rear speakers for proper implementation of the Digital Cinema Sound surround modes in the "VIRTUAL" sound fields. Refer to the illustration below.

- Select "LOW" if the location of your rear speakers corresponds to section **A**.
- Select "HIGH" if the location of your rear speakers corresponds to section **B**.

This setting only affects the surround modes in the "VIRTUAL" sound fields.

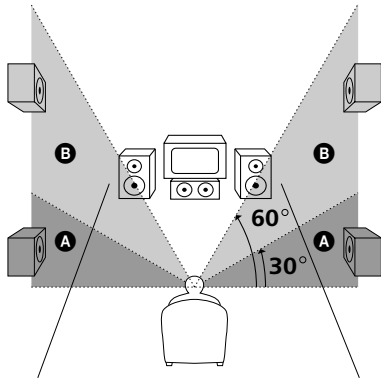

\* These parameters are not available when "Rear speaker size (REAR)" is set to "NO".

### 💡 About the rear speaker position (SIDE, and BEHIND)

This setting is designed specifically for implementation of the Digital Cinema Sound modes in the "VIRTUAL" sound fields. With the Digital Cinema Sound modes, speaker position is not as critical as other modes. All of the modes in the "VIRTUAL" sound fields were designed under the premise that the rear speaker would be located behind the listening position, but presentation remains fairly consistent even with the rear speakers positioned at a rather wide angle. However, if the speakers are pointing toward the listener from the immediate left and right of the listening position, the "VIRTUAL" sound fields will not be effective unless the rear speaker position parameter is set to "SIDE".

Nevertheless, each listening environment has many variables, such as wall reflections, and you may obtain better results using "BEHIND" if your speakers are located high above the listening position, even if they are to the immediate left and right. Therefore, although it may result in a setting contrary to the "Rear speaker position" explanation, we recommend that you play back multi channel surround encoded software and listen to the effect each setting has on your listening environment. Choose the setting that provides a good sense of spaciousness and that best succeeds in forming a cohesive space between the surround sound from the rear speakers and the sound from the front speakers. If you are not sure which sounds best, select "BEHIND" and then use the speaker distance parameter and speaker level adjustments to obtain proper balance.

### ■ Sub woofer selection (SUB WOOFER)

Initial setting : YES

- If you connect a sub woofer, select "YES".
- If you do not connect a sub woofer, select "NO". This activates the bass redirection circuitry and outputs the LFE signals from other speakers.
- In order to take full advantage of the Dolby Digital (AC-3) bass redirection circuitry, we recommend setting the sub woofer's cut off frequency as high as possible.

### ■ Front speaker distance (FRONT)

Initial setting : 16 feet

Set the distance from your listening position to the front (left or right) speaker (**A** on page 16).

- Front speaker distance can be set in 1 foot (0.1 meter) steps from 3 to 40 feet (1.0 to 12.0 meters).
- If both speakers are not placed an equal distance from your listening position, set the distance to the closest speaker.

### ■ Center speaker distance (CENTER)

Initial setting : 16 feet

Set the distance from your listening position to the center speaker.

- Center speaker distance can be set in 1 foot (0.1 meter) steps from a distance equal to the front speaker distance (**A** on page 16) to a distance 5 feet (1.5 meters) closer to your listening position (**B** on page 16).
- Do not place the center speaker farther away from your listening position than the front speakers.

### ■ Rear speaker distance (REAR)

Initial setting : 11 feet

Set the distance from your listening position to the rear (left or right) speaker.

- Rear speaker distance can be set in 1 foot (0.1 meter) steps from a distance equal to the front speaker distance (**A** on page 16) to a distance 15 feet (4.5 meters) closer to your listening position (**C** on page 16).
- Do not place the rear speakers farther away from your listening position than the front speakers.
- If both speakers are not placed an equal distance from your listening position, set the distance to the closest speaker.

### About speaker distances

This receiver allows you to input the speaker position in terms of distance. However, it is not possible to set the center speaker farther away than the front speakers. Also, the center speaker can not be set more than 5 feet (1.5 meters) closer than the front speakers.

Likewise, the rear speakers cannot be set farther away from the listening position than the front speakers. And they can be no more than 15 feet (4.5 meters) closer.

This is because incorrect speaker placement is not conducive to enjoy the surround sound.

Please note that, setting the speaker distance closer than the actual location of the speakers will cause a delay in the output of the sound from that speaker. In other words, the speaker will sound like it is farther away.

For example, setting the center speaker distance 3~6 feet (1~2 m) closer than the actual speaker position will create a fairly realistic sensation of being "inside" the screen. If you cannot obtain a satisfactory surround effect because the rear speakers are too close, setting the rear speaker distance closer (shorter) than the actual distance will create a larger soundstage. (1 foot corresponds to a 1 ms difference.)

Adjusting these parameters while listening to the sound often results in much better surround sound. Give it a try!

### Adjusting the speaker volume

Use the remote while seated in your listening position to adjust the volume of each speaker.

#### Note

This receiver incorporates a new test tone with a frequency centered at 800 Hz for easier speaker volume adjustment.

- 1 Press I/⏻ to turn on the receiver.**
- 2 Press TEST TONE on the supplied remote.**  
You will hear the test tone from each speaker in sequence.
- 3 Adjust the volume level so that the volume of the test tone from each speaker sounds the same when you are in your main listening position.**
  - To adjust the balance of the front right and front left speakers, use the front balance parameter in the LEVEL menu (see page 34).
  - To adjust the balance of the rear right and rear left speakers, use the rear balance parameter in the LEVEL menu (see page 34).
  - To adjust the volume level of the center speaker, press MENU </> to select the center parameter. Use +/- on the remote to adjust the level.
  - To adjust the volume level of the rear speaker, press MENU </> to select the rear parameter. Use +/- on the remote to adjust the level.
- 4 Press TEST TONE on the remote again to turn off the test tone.**

#### Note

The test tone cannot be output when the receiver is set to 5.1CH INPUT.

### You can adjust the volume level of all speakers at the same time

Rotate MASTER VOLUME on the receiver or press MASTER VOL +/- on the remote.

### Notes

- The front balance, rear balance, center level, and rear level are shown in the display during adjustment.
- Although these adjustments can also be made via the front panel using the LEVEL menu (when the test tone is output, the receiver switches to the LEVEL menu automatically), we recommend you follow the procedure previously described in this section and adjust the speaker levels from your listening position using the remote control.

### When setting the volume levels for each speaker

Let's assume that you have matched the sound levels of all the speakers using the test tone. Although this lays the foundation for high quality surround sound, it may be necessary to make further adjustments while listening to playback of actual software. This is because most software contains center and rear channels recorded at slightly lower levels than the two front channels.

When you actually play back software recorded in multi channel surround, you will notice that increasing the center and rear speaker levels produces a better blend between the front and center speakers and greater cohesion between the front and rear speakers. Increasing the level of the center speaker about 1 dB, and the rear speakers about 1~2 dB is likely to produce better results.

In other words, in order to create a more cohesive soundstage with balanced dialog, we recommend that you make some adjustments while playing your software. Changes of only 1 dB can make a huge difference in the character of the soundstage.

## Before You Use Your Receiver

### Before turning on the receiver

Make sure that you have:

- Selected the appropriate front speakers (see "[7] SPEAKERS selector" on page 23). (STR-DE545 and STR-SE501 only).

### Checking the connections

After connecting all of your components to the receiver, do the following to verify that the connections were made correctly.

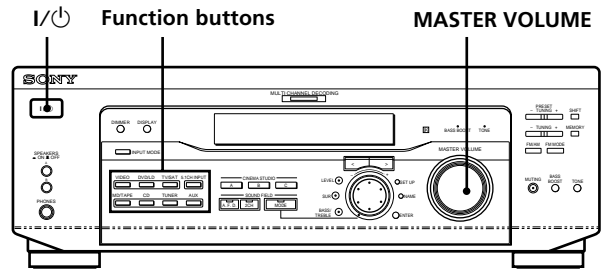

- 1 Press I/Power to turn on the receiver.
- 2 Press a function button to select a component (program source) that you connected (e.g., CD player or tape deck).
- 3 Turn on the component and start playing it.
- 4 Rotate MASTER VOLUME to turn up the volume.

If you do not obtain normal sound output after performing this procedure, look for the reason in the following checklist and take the appropriate measures to correct the problem.

### There is no sound no matter which component is selected.

- ➔ Check that both the receiver and all components are turned on.
- ➔ Check that the volume level on the display is not set to VOL MIN by turning the MASTER VOLUME.
- ➔ Check that the SPEAKERS selector is not set to OFF or to a position for front speakers that are not connected to the receiver (see "[7] SPEAKERS selector" on page 23). (STR-DE545 and STR-SE501 only)
- ➔ Check that all speaker cords are connected correctly.
- ➔ Press the MUTING button to turn off the indicator.

**There's no sound from a specific component.**

- ➔ Check that the component is connected correctly to the audio input jacks for that component.
- ➔ Check that the cord(s) used for the connection is (are) fully inserted into the jacks on both the receiver and the component.

**No sound is heard from one of the front speakers.**

- ➔ Connect a pair of headphones to the PHONES jack and set the SPEAKERS selector to OFF to verify that sound is output from the headphones (see "[7] SPEAKERS selector" and "PHONES jack" on page 23).

If only one channel is output from the headphones, the component may not be connected to the receiver correctly. Check that all the cords are fully inserted into the jacks on both the receiver and the component.

If both channels are output from the headphones, the front speaker may not be connected to the receiver correctly. Check the connection of the front speaker which is not outputting any sound.

If you encounter a problem that is not included above, see "Troubleshooting" on page 45.

# Location of Parts and Basic Operations

This chapter provides information about the locations and functions of the buttons and controls on the front panel. It also explains basic operations.

## Front Panel Parts Descriptions

### 1 I/⏻ switch

Press to turn the receiver on and off.

### 2 Function buttons

Press one of the buttons to select the component you want to use.

To select	Press
VCR	VIDEO
TV or satellite tuner	TV/SAT
DVD or LD player	DVD/LD
MD or Tape deck	MD/TAPE
CD player	CD
Built in tuner	TUNER
An audio component	AUX

After selecting the component, turn on the component you selected and play the program source.

- After selecting VCR, DVD player, or LD player, turn on the TV and set the TV's video input to match the component you selected.

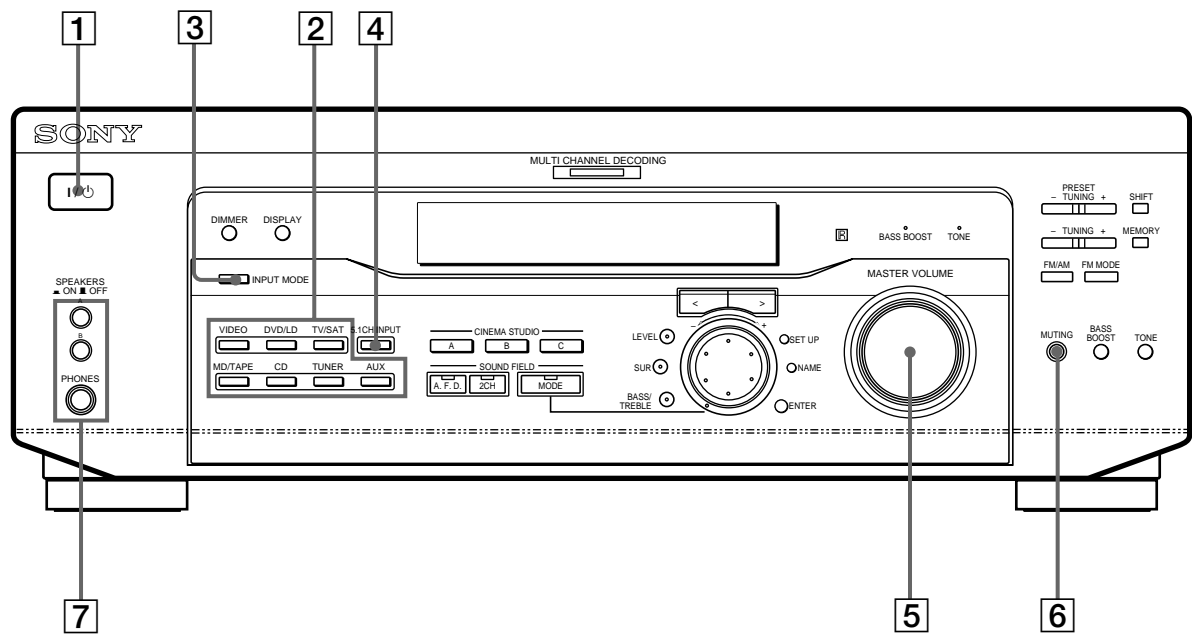

**3 INPUT MODE button**

Press to select the input mode for your digital components (DVD/LD and TV/SAT). Each press switches the input mode of the currently selected component.

Select	To
AUTO	Give priority to digital signals when there are both digital and analog connections. If there are no digital signals, analog is selected
DIGITAL (OPTICAL)	Specify the digital audio signals input to the DIGITAL OPTICAL input jacks
DIGITAL (COAXIAL)	Specify the digital audio signals input to the DIGITAL COAXIAL input jacks (DVD/LD only)
ANALOG	Specify the analog audio signals input to the AUDIO IN (L and R) jacks

**4 5.1CH INPUT button**

Press to enjoy the audio source connected to the 5.1CH INPUT jacks with the video from the selected component.

- When the 5.1CH INPUT is selected, the tone, bass boost, and sound field effects do not function.
- To change the video input displayed when 5.1CH INPUT is selected, press SET UP (22) and then press the cursor buttons (20) repeatedly to select "5.1 V. IN" (see page 44 for details).

**5 MASTER VOLUME control**

After turning on the component you selected, rotate to adjust the volume.

**6 MUTING button**

Press to mute the sound. The indicator lights up when the sound is muted.

**7 SPEAKERS selector (STR-DE545 and STR-SE501 only)**

Press according to the front speakers you want to drive.

Press	To select
A	The speakers connected to the FRONT SPEAKERS A terminals
B	The speakers connected to the FRONT SPEAKERS B terminals
A+B*	The speakers connected to both the FRONT SPEAKERS A and B terminals (parallel connection)

\* Be sure to connect the front speakers with nominal impedance of 8 ohms or higher if you want to select both sets of front speakers.

**STR-DE445 only**

Press SPEAKERS button to ON.

**PHONES jack**

Connects headphones.

- To use the headphones, press the SPEAKERS button to OFF to output sound to the headphones.
- When listening to the headphones, set the sound field to 2CH to get the correct soundstage.

## Front Panel Parts Description

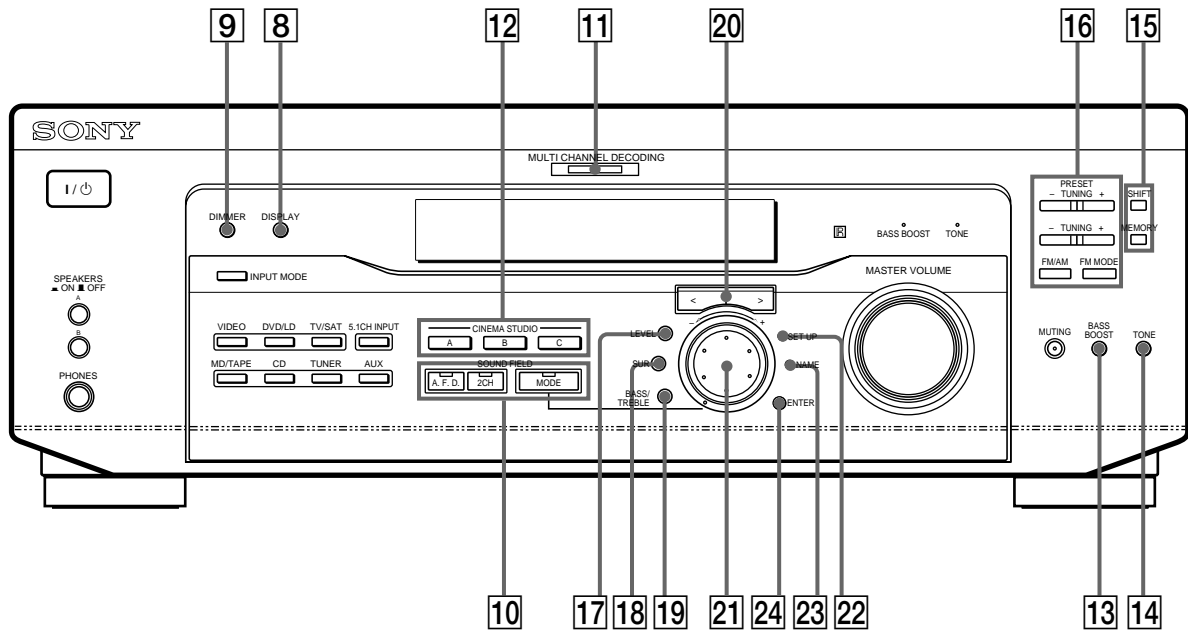

### 8 DISPLAY button

Press repeatedly to change the information on the display window as follows:

Index name of the component or the preset station\*

FUNCTION button indication or frequency\*\*

Sound field applied to the program source

\* Index name appears only when you have assigned one to the component or preset station (see page 42). Index name does not appear when only blank spaces have been entered, or it is the same as the function button.

\*\* Frequency appears only when the tuner is selected.

### 9 DIMMER button

Press repeatedly to adjust the brightness of the display.

10 Use the SOUND FIELD buttons to enjoy surround sound. For details, see “Enjoying Surround Sound” starting from page 27.

#### A.F.D. button / indicator

Press to set the receiver to automatically detect the type of audio signal being input and perform proper decoding (if necessary).

#### 2CH button / indicator

Press to output sound from only the front (left and right) speakers.

#### MODE button / indicator

Press to activate the sound field selection mode (page 28).

### 11 MULTI CHANNEL DECODING indicator

This indicator lights up when the unit is decoding signals recorded in a multi channel format.

12 Use the CINEMA STUDIO buttons to enjoy the CINEMA STUDIO sound effects.

#### A/B/C buttons

Press to activate the CINEMA STUDIO A, B or C sound field (page 29).

### 13 BASS BOOST button

Press to increase the bass of the front speakers. The BASS BOOST indicator lights up when the function is turned on.



**14 TONE button**

Press to turn the tone effect on or off. The TONE indicator lights up while the tone effect is turned on. Note that if you have adjusted the tone using the cursor buttons and jog dial, the adjusted tone will be produced whenever you turn on the tone effect.

**🔊 When you want to listen to an analog source without any digital processing**

Do the following to bypass the sound field, tone, and bass booster circuits.

- 1 Press 2CH.
- 2 Press BASS BOOST to turn off the BASS BOOST indicator.
- 3 Press TONE to turn off the TONE indicator.

The result will be a sound that is highly faithful to the program source.

**15** The following buttons operate the built-in tuner. For details, see "Receiving Broadcasts" starting from page 37.

**SHIFT button**

Selects a memory page for preset stations.

**MEMORY button**

Press to memorize a preset station.

**16** The following buttons operate the built-in tuner. For details, see "Receiving Broadcasts" starting from page 37.

**PRESET TUNING +/- buttons**

Scan all preset stations.

**TUNING +/- buttons**

Scan all the available radio stations.

**FM/AM button**

Selects the FM or AM band.

**FM MODE button**

If "STEREO" flashes in the display and the FM stereo reception is poor, press this button. You will not have the stereo effect but the sound is improved.

**17 LEVEL button**

Press to activate the speaker level parameters (page 34). The indicator on the button lights up and you can adjust the various speaker level parameters (front balance, rear balance, etc.).

**18 SUR button**

Press to activate the surround parameters (page 33). The indicator on the button lights up and you can adjust the various surround parameters (effect level, wall type, etc.).

**19 BASS/TREBLE button**

Press this button to adjust the tone (page 35).

**20 Cursor buttons (</>)**

Press to select various speaker level, surround, and bass/treble parameters (etc.).

**21 Jog dial**

Turn to adjust the selected speaker level, surround, and bass/treble parameters (etc.).

## Front Panel Parts Description

### 22 SET UP button

Press to activate the setup mode, then use the cursor buttons (20) to select any of the following indications. You can then make various settings using the jog dial (21).

When you select	You can
Speaker type	Specify the type of speakers. (page 16)
Speaker setup	Specify the front, center, rear speaker sizes, the rear speaker position, and whether or not you are using a sub woofer. (page 16)
Speaker Distance	Specify the front, center, and rear speaker distances. (page 18)
5.1CH video input	Specify the video input to be used with the audio signals from the 5.1CH INPUT jacks. (page 44)

### 23 NAME button

Press to activate the name function and enter names for preset stations and program sources (page 42).

### 24 ENTER button

Press to enter individual characters for the preset station and program source names.

# Enjoying Surround Sound

This chapter describes how to set up the receiver to enjoy surround sound. You can enjoy multi channel surround when playing back software encoded with Dolby Digital or DTS.

You can take advantage of surround sound simply by selecting one of the receiver's pre-programmed sound modes. They bring the exciting and powerful sound of movie theaters and concert halls into your home. You can also customize the sound modes to obtain the sound you desire by changing the various surround parameters. The receiver contains a variety of different sound modes. The cinema sound modes are designed for use when playing back movie software (DVD, LD, etc.) encoded with multi channel surround sound or Dolby Pro Logic. In addition to decoding the surround sound, some of these modes also provide sound effects commonly found in movie theaters.

The virtual sound modes contain compelling applications of the Sony Digital Cinema Sound digital signal processing technology. They shift the sound away from the actual speaker locations to simulate the presence of several "virtual" speakers.

The music (etc.) sound modes are designed for use with standard audio sources and TV broadcasts. They add reverberation to the source signal to make you feel as if you were in a concert hall or stadium (etc.). Use these sound modes with two-channel sources like CD and stereo broadcasts of sports programs or musical concerts. For more information about the sound modes, see pages 29 – 30.

## **A.F.D.**

The "Auto Format Decoding" sound mode presents the sound exactly as it was encoded, without adding any reverberation (etc.).

To fully enjoy surround sound, you must register the number and location of your speakers. See "Multi-Channel Surround setup" starting on page 16 to set the speaker parameters before enjoying surround sound.

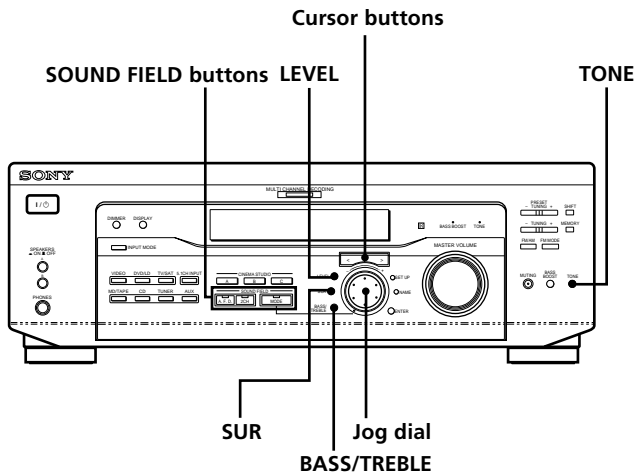

### Brief descriptions of buttons used to enjoy surround sound

**LEVEL button:** Press to customize the level parameters.

**SUR button:** Press to customize the surround parameters in the current sound field.

**BASS/TREBLE button:** Press to adjust the tone.

**Cursor buttons (</>):** Use to select parameters after pressing the LEVEL, SUR, BASS/TREBLE or SET UP buttons.

**Jog dial:** Use to adjust parameters and select sound fields (etc.).

#### SOUND FIELD buttons:

**A.F.D. button:** Press to set the receiver to automatically detect the type of audio signal being input and perform proper decoding (if necessary).

**MODE button:** Press to activate the sound field selection mode.

**2CH button:** Press to output sound from only the front (left and right) speakers.

**TONE button:** Turns the tone effect on or off.

## Selecting a Sound Field

You can enjoy surround sound simply by selecting one of the pre-programmed sound fields according to the program you want to listen to.

### 1 Press MODE.

The current sound field is indicated in the display.

### 2 Turn the jog dial or press the cursor buttons (< or >) to select the sound field you want.

See the table starting on page 29 for information on each sound field.

#### To turn the sound field off

Press A.F.D. or 2CH (page 24).

#### 💡 The receiver memorizes the last sound field selected for each program source (Sound Field Link)

Whenever you select a program source, the sound field that was last applied is automatically applied again. For example, if you listen to CD with HALL as the sound field, change to a different program source, then return to CD, HALL will be applied again. With the tuner, sound fields are memorized separately for AM, FM, and all preset stations.

#### 💡 You can identify Dolby Surround-encoded software by looking at the packaging

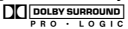
Dolby Digital discs are labeled with the  logo, and Dolby Surround encoded programs are labeled with the  logo.

## Sound field information

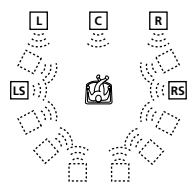
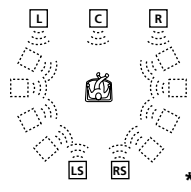
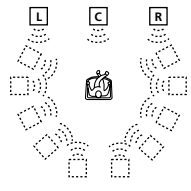
Sound field	Effect	Notes
NORM. SUR (NORMAL SURROUND)	Software with multi channel surround audio signals is played according to the way it was recorded. Software with two channel audio signals, is decoded with Dolby Pro Logic to create surround effects.	
C. STUDIO A (CINEMA STUDIO A)	Reproduces the sound characteristics of the Sony Pictures Entertainment "Cary Grant Theater" cinema production studio.	This is a standard mode, great for watching most type of movie.
C. STUDIO B (CINEMA STUDIO B)	Reproduces the sound characteristics of the Sony Pictures Entertainment "Kim Novak Theater" cinema production studio.	This mode is ideal for watching science-fiction or action movies with lots of sound effects.
C. STUDIO C (CINEMA STUDIO C)	Reproduces the sound characteristics of the Sony Pictures Entertainment scoring stage.	This mode is ideal for watching musicals or classic films where music is featured in the soundtrack.
V. MULTI* (VIRTUAL MULTI DIMENSION)	Uses 3D sound imaging to create an array of virtual rear speakers positioned higher than the listener from a single pair of actual rear speakers. This mode creates four sets of virtual speakers surrounding the listener at approximately a 30° angle of elevation.	<div style="display: flex; align-items: center;"> <div style="margin-right: 20px;">SIDE**</div>  </div> <div style="display: flex; align-items: center;"> <div style="margin-right: 20px;">BEHIND**</div>  </div> <div style="text-align: right; margin-top: 10px;">** See page 17</div>
V. SEMI-M* (VIRTUAL SEMI-MULTI DIMENSION)	Uses 3D sound imaging to create virtual rear speakers from the sound of the front speakers without using actual rear speakers. This mode creates five sets of virtual speakers surrounding the listener at a 30° angle of elevation.	

\* "VIRTUAL" sound field: Sound field with virtual speakers.

## Selecting a Sound Field

### Sound field information

Sound field	Effect	Notes
HALL	Reproduces the acoustics of a rectangular concert hall.	Ideal for soft acoustic sounds.
JAZZ (JAZZ CLUB)	Reproduces the acoustics of a jazz club.	
LIVE (LIVE HOUSE)	Reproduces the acoustics of a 300-seat live house.	Great for rock or pop music.
GAME	Obtains maximum audio impact from video game software.	Be sure to set the game machine to stereo mode when using game software with stereo sound capabilities.

#### Notes

- The effects provided by the virtual speakers may cause increased noise in the play back signal.
- When listening to sound fields that employ the virtual speakers, you will not be able to hear any sound coming directly from the rear speakers.

### Use the buttons on the front panel to operate the following modes

AUTO FORMAT DECODING (Press the A.F.D. button)	Automatically detects the type of audio signal being input (Dolby Digital, Dolby Pro Logic, or standard two channel stereo) and performs the proper decoding if necessary. This mode presents the sound as it was recorded/encoded, without adding any effects.	You can use this mode as a reference. Set the tone to OFF while using this mode to hear the source sound exactly as it was recorded.
2 CHANNEL (Press the 2CH button)	Outputs the sound from the front left and right speakers only. Standard two channel (stereo) sources completely bypass the sound field processing. Multi channel surround formats are downmixed to two channels.	This allows you to play any source using only the front left and right speakers.

#### Note

No sound is output from the sub woofer when the 2 CHANNEL mode is selected. To listen to two channel (stereo) sources using the front left and right speakers and a sub woofer, use the AUTO FORMAT DECODING mode.



## Understanding the Multi-Channel Surround Displays

### Source sound displays

The letters (L, C, R, etc.) indicate the source sound. The box around the letters varies to show how the receiver downmixes the source sound (based on the speakers settings). When using music sound modes such as HALL or JAZZ CLUB, the receiver adds reverberation based on the source sound.

The following table shows how the indicators light up when using AUTO FORMAT DECODING mode.

Although the table below shows almost all of the configurations available from multi channel surround signals, the ones marked “☆” are the most common.

Recording Format (Front/Rear)	Input Channel Display	Source sound and Output Channel Display			
		All speakers present	Rear speakers absent	Center speaker absent	Rear/center speakers absent
1/0	DOLBY DIGITAL [1/0]	<input checked="" type="checkbox"/> DIGITAL <input checked="" type="checkbox"/> C	<input checked="" type="checkbox"/> DIGITAL <input checked="" type="checkbox"/> C	<input checked="" type="checkbox"/> DIGITAL <input type="checkbox"/> c <input type="checkbox"/>	<input checked="" type="checkbox"/> DIGITAL <input type="checkbox"/> c <input type="checkbox"/>
	DTS [1/0]	_____ <input checked="" type="checkbox"/> C	_____ <input checked="" type="checkbox"/> C	_____ <input type="checkbox"/> c <input type="checkbox"/>	_____ <input type="checkbox"/> c <input type="checkbox"/>
2/0*	DOLBY DIGITAL [2/0]	_____ <input type="checkbox"/> L <input type="checkbox"/> R	_____ <input type="checkbox"/> L <input type="checkbox"/> R	_____ <input type="checkbox"/> L <input type="checkbox"/> R	_____ <input type="checkbox"/> L <input type="checkbox"/> R
	DTS [2/0]	_____ <input type="checkbox"/> L <input type="checkbox"/> R	_____ <input type="checkbox"/> L <input type="checkbox"/> R	_____ <input type="checkbox"/> L <input type="checkbox"/> R	_____ <input type="checkbox"/> L <input type="checkbox"/> R
3/0	DOLBY DIGITAL [3/0]	<input checked="" type="checkbox"/> DIGITAL <input type="checkbox"/> L <input type="checkbox"/> C <input type="checkbox"/> R	<input checked="" type="checkbox"/> DIGITAL <input type="checkbox"/> L <input type="checkbox"/> C <input type="checkbox"/> R	<input checked="" type="checkbox"/> DIGITAL <input type="checkbox"/> L <input type="checkbox"/> c <input type="checkbox"/> R	<input checked="" type="checkbox"/> DIGITAL <input type="checkbox"/> L <input type="checkbox"/> c <input type="checkbox"/> R
	DTS [3/0]	_____ <input type="checkbox"/> L <input type="checkbox"/> C <input type="checkbox"/> R	_____ <input type="checkbox"/> L <input type="checkbox"/> C <input type="checkbox"/> R	_____ <input type="checkbox"/> L <input type="checkbox"/> c <input type="checkbox"/> R	_____ <input type="checkbox"/> L <input type="checkbox"/> c <input type="checkbox"/> R
2/1	DOLBY DIGITAL [2/1]	<input checked="" type="checkbox"/> DIGITAL <input type="checkbox"/> L <input type="checkbox"/> R <input type="checkbox"/> S	<input checked="" type="checkbox"/> DIGITAL <input type="checkbox"/> L <input type="checkbox"/> R <input type="checkbox"/> S	<input checked="" type="checkbox"/> DIGITAL <input type="checkbox"/> L <input type="checkbox"/> R <input type="checkbox"/> S	<input checked="" type="checkbox"/> DIGITAL <input type="checkbox"/> L <input type="checkbox"/> R <input type="checkbox"/> S
	DTS [2/1]	_____ <input type="checkbox"/> L <input type="checkbox"/> R <input type="checkbox"/> S	_____ <input type="checkbox"/> L <input type="checkbox"/> R <input type="checkbox"/> S	_____ <input type="checkbox"/> L <input type="checkbox"/> R <input type="checkbox"/> S	_____ <input type="checkbox"/> L <input type="checkbox"/> R <input type="checkbox"/> S
3/1	DOLBY DIGITAL [3/1]	<input checked="" type="checkbox"/> DIGITAL <input type="checkbox"/> L <input type="checkbox"/> C <input type="checkbox"/> R <input type="checkbox"/> S	<input checked="" type="checkbox"/> DIGITAL <input type="checkbox"/> L <input type="checkbox"/> C <input type="checkbox"/> R <input type="checkbox"/> S	<input checked="" type="checkbox"/> DIGITAL <input type="checkbox"/> L <input type="checkbox"/> c <input type="checkbox"/> R <input type="checkbox"/> S	<input checked="" type="checkbox"/> DIGITAL <input type="checkbox"/> L <input type="checkbox"/> c <input type="checkbox"/> R <input type="checkbox"/> S
	DTS [3/1]	_____ <input type="checkbox"/> L <input type="checkbox"/> C <input type="checkbox"/> R <input type="checkbox"/> S	_____ <input type="checkbox"/> L <input type="checkbox"/> C <input type="checkbox"/> R <input type="checkbox"/> S	_____ <input type="checkbox"/> L <input type="checkbox"/> c <input type="checkbox"/> R <input type="checkbox"/> S	_____ <input type="checkbox"/> L <input type="checkbox"/> c <input type="checkbox"/> R <input type="checkbox"/> S
2/2	DOLBY DIGITAL [2/2]	<input checked="" type="checkbox"/> DIGITAL <input type="checkbox"/> L <input type="checkbox"/> R <input type="checkbox"/> LS <input type="checkbox"/> RS	<input checked="" type="checkbox"/> DIGITAL <input type="checkbox"/> L <input type="checkbox"/> R <input type="checkbox"/> LS <input type="checkbox"/> RS	<input checked="" type="checkbox"/> DIGITAL <input type="checkbox"/> L <input type="checkbox"/> R <input type="checkbox"/> LS <input type="checkbox"/> RS	<input checked="" type="checkbox"/> DIGITAL <input type="checkbox"/> L <input type="checkbox"/> R <input type="checkbox"/> LS <input type="checkbox"/> RS
	DTS [2/2]	_____ <input type="checkbox"/> L <input type="checkbox"/> R <input type="checkbox"/> LS <input type="checkbox"/> RS	_____ <input type="checkbox"/> L <input type="checkbox"/> R <input type="checkbox"/> LS <input type="checkbox"/> RS	_____ <input type="checkbox"/> L <input type="checkbox"/> R <input type="checkbox"/> LS <input type="checkbox"/> RS	_____ <input type="checkbox"/> L <input type="checkbox"/> R <input type="checkbox"/> LS <input type="checkbox"/> RS
3/2	☆ DOLBY DIGITAL [3/2]	<input checked="" type="checkbox"/> DIGITAL <input type="checkbox"/> L <input type="checkbox"/> C <input type="checkbox"/> R <input type="checkbox"/> LS <input type="checkbox"/> RS	<input checked="" type="checkbox"/> DIGITAL <input type="checkbox"/> L <input type="checkbox"/> C <input type="checkbox"/> R <input type="checkbox"/> LS <input type="checkbox"/> RS	<input checked="" type="checkbox"/> DIGITAL <input type="checkbox"/> L <input type="checkbox"/> c <input type="checkbox"/> R <input type="checkbox"/> LS <input type="checkbox"/> RS	<input checked="" type="checkbox"/> DIGITAL <input type="checkbox"/> L <input type="checkbox"/> c <input type="checkbox"/> R <input type="checkbox"/> LS <input type="checkbox"/> RS
	☆ DTS [3/2]	_____ <input type="checkbox"/> L <input type="checkbox"/> C <input type="checkbox"/> R <input type="checkbox"/> LS <input type="checkbox"/> RS	_____ <input type="checkbox"/> L <input type="checkbox"/> C <input type="checkbox"/> R <input type="checkbox"/> LS <input type="checkbox"/> RS	_____ <input type="checkbox"/> L <input type="checkbox"/> c <input type="checkbox"/> R <input type="checkbox"/> LS <input type="checkbox"/> RS	_____ <input type="checkbox"/> L <input type="checkbox"/> c <input type="checkbox"/> R <input type="checkbox"/> LS <input type="checkbox"/> RS
2/0**	☆ DOLBY DIGITAL [2/0]	_____ <input type="checkbox"/> L <input type="checkbox"/> C <input type="checkbox"/> R <input type="checkbox"/> PRO LOGIC <input type="checkbox"/> S	_____ <input type="checkbox"/> L <input type="checkbox"/> C <input type="checkbox"/> R <input type="checkbox"/> PRO LOGIC <input type="checkbox"/> S	_____ <input type="checkbox"/> L <input type="checkbox"/> c <input type="checkbox"/> R <input type="checkbox"/> PRO LOGIC <input type="checkbox"/> S	_____ <input type="checkbox"/> L <input type="checkbox"/> R
	☆ DOLBY PROLOGIC	_____ <input type="checkbox"/> L <input type="checkbox"/> C <input type="checkbox"/> R <input type="checkbox"/> PRO LOGIC <input type="checkbox"/> S	_____ <input type="checkbox"/> L <input type="checkbox"/> C <input type="checkbox"/> R <input type="checkbox"/> PRO LOGIC <input type="checkbox"/> S	_____ <input type="checkbox"/> L <input type="checkbox"/> c <input type="checkbox"/> R <input type="checkbox"/> PRO LOGIC <input type="checkbox"/> S	_____ <input type="checkbox"/> L <input type="checkbox"/> R
	☆ PCM XX kHz***	_____ <input type="checkbox"/> L <input type="checkbox"/> R	_____ <input type="checkbox"/> L <input type="checkbox"/> R	_____ <input type="checkbox"/> L <input type="checkbox"/> R	_____ <input type="checkbox"/> L <input type="checkbox"/> R

\* Signals with Dolby surround encoded flag OFF

\*\* Signals with Dolby surround encoded flag ON

\*\*\* The sampling rate is displayed.

### Notes

- The receiver performs Pro Logic decoding and the display conforms to 2/0\*\* when using the following movie sound modes with 2/0\* or STEREO PCM format signals. (C. STUDIO A, B, C, V. MULTI and V. SEMI-M.)
- When using music sound modes such as HALL or JAZZ CLUB with standard audio formats e.g., PCM, the receiver creates rear signals from the front L and R signals. In this case, sound is output from the rear speakers, but output channel indicators for the rear speakers do not light.



# Customizing Sound Fields

By adjusting the surround parameters and the tone characteristics of the front speakers, you can customize the sound fields to suit your particular listening situation.

Once you customize a sound field, the changes are stored in memory indefinitely (unless the receiver is unplugged for about two weeks). You can change a customized sound field any time by making new adjustments to the parameters.

See the table on page 36 for the parameters available in each sound field.

## To get the most from multi channel surround sound

Position your speakers and do the procedures described in “Multi Channel Surround Setup” starting on page 16 before you customize a sound field.

## Adjusting the surround parameters

The SUR menu contains parameters that let you customize various aspects of the current sound field. The settings available in this menu are stored individually for each sound field.

- 1 Start playing a program source encoded with multi channel surround sound.**
- 2 Press SUR.**  
The button lights up and the first parameter is displayed.
- 3 Press the cursor buttons (< or >) to select the parameter you want to adjust.**
- 4 Turn the jog dial to select the setting you want.**  
The setting is stored automatically.

### Effect level (EFFECT)

Initial setting : (depends on sound mode)

This parameter lets you adjust the “presence” of the current surround effect.

### Wall type (WALL)

Initial setting : midpoint

When sound is reflected off soft material, such as a curtain, the high frequency elements are reduced. A hard wall is highly reflective and does not significantly affect the frequency response of the reflected sound. This parameter lets you control the level of the high frequencies to alter the sonic character of your listening environment by simulating a softer (S) or harder (H) wall. The midpoint designates a neutral wall (made of wood).

### Reverberation (REVB.)

Initial setting : midpoint

Before sound reaches our ears, it is reflected (reverberated) many times between the left and right walls, ceiling, and floor. In a large room, sound takes more time to bounce from one surface to another than in a smaller room. This parameter lets you control the spacing of the early reflections to simulate a sonically larger (L) or smaller (S) room.

- The reverberation can be adjusted from REVB. S. 1 ~ REVB. S. 8 (short) to REVB. L. 1 ~ REVB. L. 8 (long) in 17 steps.
- The midpoint REVB. MID designates a standard room with no adjustment.

### Adjusting the level parameters

The LEVEL menu contains parameters that let you adjust the balance and speaker volumes of each speaker. The settings available in this menu are applied to all sound fields.

- 1 Start playing a program source encoded with multi channel surround sound.
- 2 Press LEVEL.  
The button lights up and the first parameter is displayed.
- 3 Press the cursor buttons (< or >) to select the parameter you want to adjust.
- 4 Turn the jog dial to select the setting you want.  
The setting is stored automatically.

#### \*Front balance (L R)

Initial setting : balance

Lets you adjust the balance between the front left and right speakers.

- The balance can be adjusted  $\pm 8$  steps.
- These settings can also be adjusted using the supplied remote. See "Adjusting the speaker volume" (page 19).

#### \*Rear balance (LS RS)

Initial setting : balance

Lets you adjust the balance between the rear left and right speakers.

- The balance can be adjusted  $\pm 8$  steps.
- These settings can also be adjusted using the supplied remote. See "Adjusting the speaker volume" (page 19).

#### \*Rear level (REAR)

Initial setting : 0 dB

Lets you adjust level of the rear (left and right) speakers.

- The level can be adjusted in 1 dB steps from -10 dB to +6 dB.
- These settings can also be adjusted directly using the supplied remote. See "Adjusting the speaker volume" (page 19).

#### \*Center level (CTR)

Initial setting : 0 dB

Lets you adjust the level of the center speaker.

- The level can be adjusted in 1 dB steps from -10 dB to +6 dB.

#### \*Sub woofer level (S.W. xx)

Initial setting : 0 dB

Lets you adjust the level of the sub woofer.

- The level can be adjusted in 1 dB steps from -10 dB to +6 dB.

\* The parameters can be adjusted separately for 5.1 CH INPUT.

#### LFE (Low Frequency Effect) mix level (LFE xx)

Initial setting : 0 dB

This parameter lets you attenuate the level of the LFE (Low Frequency Effect) channel output from the sub woofer without affecting the level of the bass frequencies sent to the sub woofer from the front, center or rear channels via the bass redirection circuitry.

- The level can be adjusted in 1 dB steps from -20.0 dB to 0 dB (line level). 0 dB outputs the full LFE signal at the mix level determined by the recording engineer.
- Selecting OFF mutes the sound of the LFE channel from the sub woofer. However, the low frequency sounds of the front, center, or rear speakers are output from the sub woofer according to the settings made for each speaker in the speaker setup (page 16).

#### dts LFE (Low Frequency Effect) mix level

(LFE  xx)

Initial setting: 0 dB

This parameter lets you attenuate the level of the LFE (Low Frequency Effect) channel output from the sub woofer without affecting the level of the bass frequencies sent to the sub woofer from the front, center or rear channels via the "dts" bass redirection circuitry.

- The level can be adjusted in 1 dB steps from -20.0 dB to +10.0 dB (line level).
- Selecting OFF mutes the sound of the LFE channel from the sub woofer. However, the low frequency sounds of the front, center, or rear speakers are output from the sub woofer according to the settings made for each speaker setup (For details, refer to "Multi Channel Surround Setup").

#### About the level differences in the LFE MIX settings

The "dts LFE MIX" level is set to +10.0 dB and "LFE MIX" (Dolby Digital) is set to 0 dB. This is because there is an initial difference of 10 dB in the overall mix between the Dolby Digital and dts LFE channel levels. Essentially, with the "dts LFE MIX" level set to +10 dB and the "LFE MIX (Dolby Digital)" level set to 0 dB, approximately the same amounts of LFE channel signal are distributed to the other audio channels in the overall mix.

**Dynamic range compressor (COMP.  xx)**

Initial setting : OFF

Lets you compress the dynamic range of the sound track. This may be useful when you want to watch movies at low volumes late at night.

- OFF reproduces the sound track with no compression.
- STD reproduces the sound track with the dynamic range intended by the recording engineer.
- 0.1 ~ 0.9 allow you to compress the dynamic range in small steps to achieve the sound you want.
- MAX provides a dramatic compression of the dynamic range.

**Note**

Dynamic range compression does not work with DTS sources.

** About the Dynamic Range Compressor**

This parameter allows you to compress the dynamic range of the soundtrack based on the dynamic range information included in the Dolby Digital signal. "STD" is standard compression, but because many sources have only light compression, you may not notice much difference when using 0.1~0.9.

Therefore, we recommend using the "MAX" setting. This greatly compresses the dynamic range and allows you to view movies late at night at low volumes. Unlike analog limiters, the levels are predetermined and it provides a very natural compression.

**Adjusting the bass/treble**

The BASS/TREBLE button lets you adjust the tone (bass or treble) of the front speakers for optimum sound. You can adjust the tone for each separate sound field.

**1 Start playing a program source encoded with multi channel surround sound.**

**2 Press BASS/TREBLE.**

The button lights up and the first parameter is displayed.

**3 Press the cursor buttons (< or >) to select the parameter you want to adjust.**

**4 Turn the jog dial to select the setting you want.**

The setting is stored automatically.

You can select a tone level of -6 dB to +6 dB in 2 dB steps.

**5 Press TONE so that the TONE indicator lights up.**

** You can turn off the tone without erasing it**

The tone settings are stored separately for each sound field. Press the TONE button to turn the TONE indicator off.

**Resetting customized sound fields to the factory settings**

**1 If the power is on, press I/⏻ to turn off the power.**

**2 Hold down MODE and press I/⏻.**

"SUR CLR" appears in the display and all sound fields are reset at once.

## Customizing Sound Fields

### Adjustable parameters for each sound field

	EFFECT LEVEL	WALL TYPE	REVERB TIME	FRONT BAL.	REAR BAL.	REAR LEVEL	CENTER LEVEL	SUB WOOFER LEVEL	LFE MIX	dts LFE mix
2CH				●					●	●
A.F.D.				●	●	●	●	●	●	●
NORMAL SURROUND				●	●	●	●	●	●	●
CINEMA STUDIO A	●			●	●	●	●	●	●	●
CINEMA STUDIO B	●			●	●	●	●	●	●	●
CINEMA STUDIO C	●			●	●	●	●	●	●	●
V. MULTI DIMENSION				●	●	●	●	●	●	●
V. SEMI-M. DIMENSION				●			●	●	●	●
HALL	●	●	●	●	●	●	●	●	●	●
JAZZ CLUB	●	●	●	●	●	●	●	●	●	●
LIVE HOUSE	●	●	●	●	●	●	●	●	●	●
GAME	●	●	●	●	●	●	●	●	●	●
5.1CH INPUT				●	●	●	●	●		

### D.RANGE COMP. BASS/TREBLE

	D.RANGE COMP.	BASS/TREBLE
2CH	●	●
A.F.D.	●	●
NORMAL SURROUND	●	●
CINEMA STUDIO A	●	●
CINEMA STUDIO B	●	●
CINEMA STUDIO C	●	●
V. MULTI DIMENSION	●	●
V. SEMI-M. DIMENSION	●	●
HALL	●	●
JAZZ CLUB	●	●
LIVE HOUSE	●	●
GAME	●	●
5.1CH INPUT		

# Receiving Broadcasts

This chapter describes how to receive FM or AM broadcasts and how to preset selected stations.

You can tune in stations on this receiver in the following ways:

## **Direct Tuning**

You can enter a frequency of the station you want directly by using the numeric buttons on the remote (see page 39).

## **Automatic Tuning**

If you don't know the frequency of the station you want, you can let the receiver scan all available stations in your area (see page 39).

## **Preset Tuning**

After you have tuned in stations using Direct Tuning or Automatic Tuning, you can preset them to the receiver (see page 40). Then you can tune in any of the stations directly by entering its 2-character code (see page 40). Up to 30 FM or AM stations can be preset. The receiver will also scan all the stations that you have preset (see page 40).

Before you begin, make sure you have:

- Connected an FM and AM antenna to the receiver (see page 5).
- Selected the appropriate speaker system (see page 23). (STR-DE545 and STR-SE501 only)

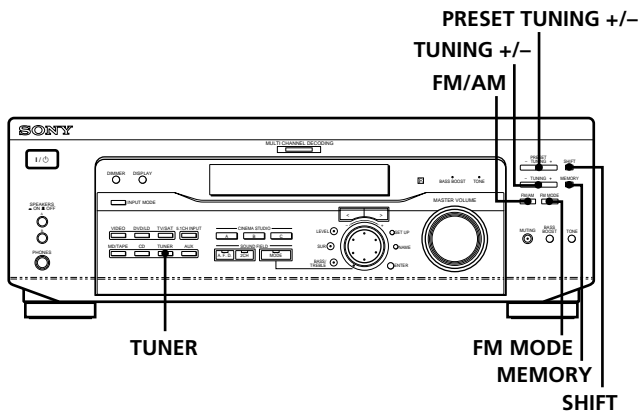

STR-DE445 only

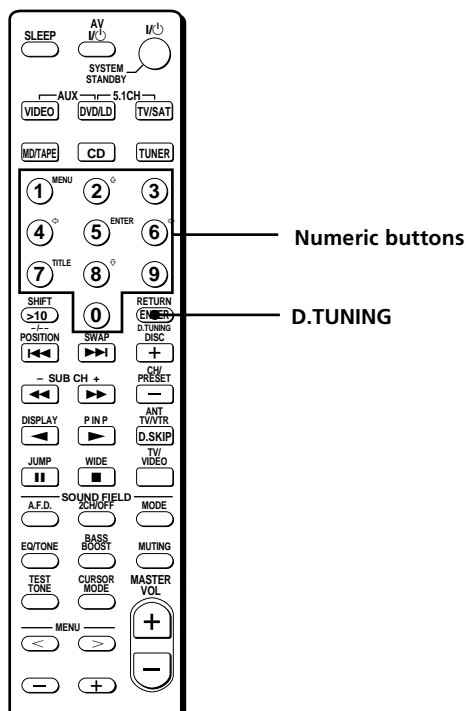

### Brief descriptions of buttons used to receive broadcasts

**PRESET TUNING +/-:** Press to scan all preset radio stations.

**TUNING +/-:** Press to scan all available radio stations.

**FM MODE:** If "STEREO" flashes in the display and the FM stereo reception is poor, press this button to improve the sound. You will not be able to enjoy stereo effect but the sound will be less distorted.

**Note**

If "STEREO" does not appear at all even when the FM broadcast is received normally, press this button to turn on the "STEREO" indication.

**FM/AM:** Press to select the FM or AM band.

**MEMORY:** Uses for memorizing preset stations.

**SHIFT:** Press to select a memory page (A, B, or C) for presetting radio stations or tuning to preset stations.

**TUNER:** Press to select the tuner.

**On the remote (STR-DE445 only):**

**D. TUNING:** Press this button to enter a frequency directly using the numeric buttons.

**Numeric buttons:** Press to enter a numeric value when inputting the frequency directly, presetting radio stations, or tuning to preset stations.

## Direct Tuning

For details on the buttons used in this section, see “Brief descriptions of buttons used to receive broadcasts” on page 38.

- 1 Press TUNER.**  
The last received station is tuned in.
- 2 Press FM/AM to select the FM or AM band.**
- 3 Press D.TUNING on the remote.**
- 4 Press the numeric buttons on the remote to enter the frequency.**

Example 1: FM 102.50 MHz

① → ② → ⑤ → ①

Example 2: AM 1350 kHz

(You don't have to enter the last “0” when the tuning interval is set to 10 kHz)

① → ③ → ⑤

### If you cannot tune in a station and the entered numbers flash

Make sure you've entered the right frequency. If not, repeat Steps 3 and 4.

If the entered numbers still flash, the frequency is not used in your area.

- 5 If you've tuned in an AM station, adjust the direction of the AM loop antenna for optimum reception.**
- 6 Repeat Steps 2 to 5 to receive other stations.**

### If you try to enter a frequency not covered by the tuning interval

The entered value is automatically rounded up or down.

Tuning intervals for direct tuning are:

**FM:** 50 kHz

**AM:** 10 kHz (to change to 9 kHz, see page 48.)

## Automatic Tuning

For details on the buttons used in this section, see “Brief descriptions of buttons used to receive broadcasts” on page 38.

- 1 Press TUNER.**  
The last received station is tuned in.
- 2 Press FM/AM to select the FM or AM band.**
- 3 Press TUNING + or TUNING –.**  
Press the + button to scan from low to high; press the – button to scan from high to low.

### When the receiver reaches either end of the band

Scanning is repeated in the same direction.

The receiver stops scanning whenever a station is received.

- 4 To continue scanning, press TUNING + or TUNING – again.**

# Preset Tuning

For details on the buttons used in this section, see “Brief descriptions of buttons used to receive broadcasts” on page 38.

Before tuning to preset stations, be sure to preset them by performing steps on “Presetting radio stations” below.

## Presetting radio stations

- 1 Press TUNER.**  
The last received station is tuned in.
- 2 Tune in the station that you want to preset using Direct Tuning or Automatic Tuning (page 39).**
- 3 Press MEMORY.**  
“MEMORY” appears in the display for a few seconds. Do Steps 4 to 6 before “MEMORY” goes out.
- 4 Press SHIFT to select a memory page (A, B or C).**  
Each time you press SHIFT, the letter “A”, “B” or “C” appears in the display.
- 5 Select a preset number by pressing PRESET TUNING + or PRESET TUNING –.**  
If “MEMORY” goes out before you press the preset number, start again from Step 3.
- 6 Press MEMORY again to store the station.**  
If “MEMORY” goes out before you can store the station, start again from Step 3.
- 7 Repeat Steps 2 to 6 to preset another station.**

### To change a preset number to another station

Do Steps 1 to 6 to preset the new station to the number.

#### Note

If the AC power cord is disconnected for about two weeks, all the preset stations will be cleared from the receiver’s memory, and you will have to preset the stations again.

## Tuning to preset stations

You can tune the preset stations either of the following two ways.

### Scanning the preset stations

- 1 Press TUNER.**  
The last received station is tuned in.
- 2 Press PRESET TUNING + or PRESET TUNING – repeatedly to select the preset station you want.**  
Each time you press the button, the receiver tunes in one preset station at a time, in the corresponding order and direction as follows:

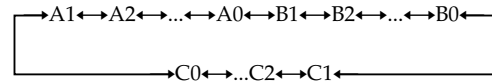

### Using the preset codes

- 1 Press TUNER.**  
The last received station is tuned in.
- 2 Press SHIFT to select a memory page (A, B or C), then press the preset number of the station you want using the numeric buttons on the supplied remote.**



# Other Operations

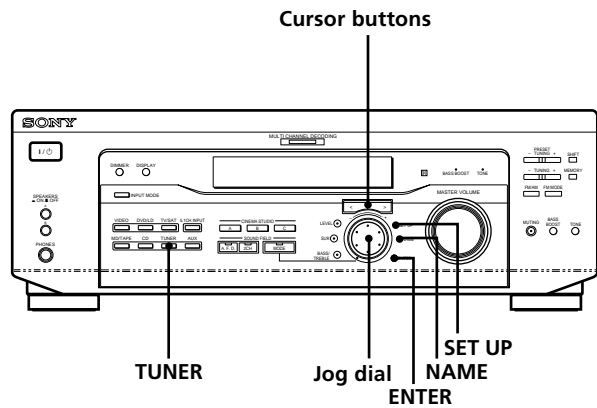

## Brief descriptions of buttons that appear in this chapter

**NAME button:** Press to name preset stations or program sources.

**Jog dial:** Use to select characters when naming preset stations or program sources.

**Cursor buttons (< />):** Use to move the cursor when naming preset stations or program sources.

**TUNER button:** Press to select the tuner.

**SET UP button:** Press to enter the set up mode.

**ENTER button:** Press to enter the completed name of the preset station or program source.

## Naming Preset Stations and Program Sources

You can enter a name (index name) of up to 8 characters for preset stations and program sources. These names (for example, "VHS") appear in the receiver's display when a station or program source is selected.

Note that no more than one name can be entered for each preset station or program source.

This function is useful for distinguishing components of the same kind. For example, two VCRs can be specified as "VHS" and "8MM", respectively. It is also handy for identifying components connected to jacks meant for another type of component, for example, a second CD player connected to the MD/TAPE jacks.

### 1 To name a preset station

Press **TUNER**.

The last station you received is tuned in.

### To name a program source

Select the program source (component) to be named, then go to Step 3.

### 2 Tune in the preset station you want to create an index name for.

If you are not familiar with how to tune in preset stations, see "Tuning to preset stations" on page 40.

### 3 Press **NAME**.

### 4 Create an index name by using the jog dial and cursor buttons:

Turn the jog dial to select a character, then press **>** to move the cursor to the next position.

### To insert a space

Turn the jog dial until a blank space appears in the display (you can find the space character between "I" and "A").

### If you've made a mistake

Press **<** or **>** repeatedly until the character to be changed flashes, then turn the jog dial to select the right character.

### 5 Press **ENTER**.

### To assign index names to other stations

Repeat Steps 2 to 5.

## Recording

Your receiver makes it easy to record to and from the components connected to it. You don't have to connect the playback and recording components directly to each other: once you select a program source on the receiver, you can record and edit as you normally would using the controls on each component.

Before you begin, make sure you've connected all components properly.

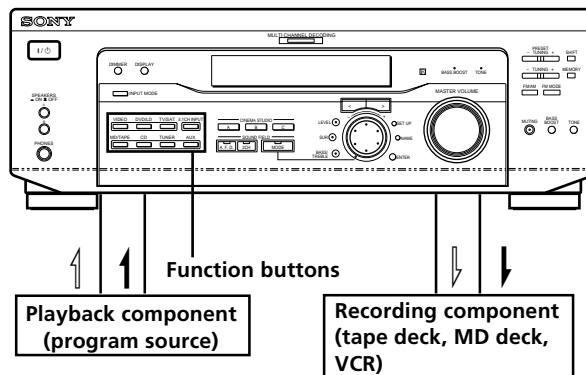

↔: Audio signal flow

→: Video signal flow

### Recording on an audio tape or MiniDisc

You can record on a cassette tape or MiniDisc using the receiver. Refer to the instruction manual of your cassette deck or MD deck if you need help.

#### 1 Select the component to be recorded.

#### 2 Prepare the component for playing.

For example, insert a CD into the CD player.

#### 3 Insert a blank tape or MD into the recording deck and adjust the recording level, if necessary.

#### 4 Start recording on the recording deck, then start playback on the playback component.

#### Notes

- You cannot record a digital audio signal using a component connected to the analog MD/TAPE REC OUT jacks.
- Sound adjustments do not affect the signal output from the MD/TAPE REC OUT jacks.

## Recording on a video tape

You can record from a TV, or an LD player using the receiver. You can also add audio from a variety of audio sources when editing a video tape. See your LD player's instruction manual if you need help.

- 1 Select the program source to be recorded.**
- 2 Prepare the component for playing.**  
For example, insert the laser disc you want to record into the LD player.
- 3 Insert a blank video tape into the VCR for recording.**
- 4 Start recording on the recording VCR, then start playing the laser disc you want to record.**

### You can record the sound from any audio source onto a video tape while recording from a laser disc

Locate the point where you want to start recording from another audio source, select the program source, then start playback. The audio from that source will be recorded onto the audio track of the video tape instead of the audio from the original medium.

To resume audio recording from the original medium, select the video source again.

### Note

Please be sure to make both digital and analog connections to the DVD/LD inputs. Analog recording is not possible if you only make digital connections.

## Using the Sleep Timer

You can set the receiver to turn off automatically at a specified time.

**Press SLEEP on the remote while the power is on.** Each time you press SLEEP, the time changes as shown below.

→ 2:00:00 → 1:30:00 → 1:00:00 → 0:30:00 → OFF →

The display dims after you have specified the time.

### You can freely specify the time

First, press SLEEP on the remote, then specify the time you want using the jog dial on the receiver. The sleep time changes in 1 minute intervals. You can specify up to 5 hours.

### You can check the time remaining before the receiver turns off

Press SLEEP on the remote. The remaining time appears in the display.

---

# Adjustment Using the SET UP Button

The SET UP button allows you to make the following adjustments.

## Selecting the 5.1CH video input

This parameter lets you specify the video input to be used with the audio signals from the 5.1CH INPUT jack. The 5.1 CH video input is set to DVD/LD by default.

- 1** Press SET UP.
- 2** Press the cursor buttons (< or >) to select "5.1 V. IN".
- 3** Turn the jog dial to select the video input you want.

# Additional Information

---

## Troubleshooting

If you experience any of the following difficulties while using the receiver, use this troubleshooting guide to help you remedy the problem. Also, see “Checking the connections” on page 20 to verify that the connections are correct. Should any problem persist, consult your nearest Sony dealer.

### **There’s no sound or only a very low-level sound is heard.**

- ➔ Check that the speakers and components are connected securely.
- ➔ Make sure that you’ve selected the correct component on the receiver.
- ➔ Make sure that you’ve set the SPEAKERS selector correctly (see page 23). (STR-DE545 and STR-SE501 only)
- ➔ Press MUTING on the remote if the MUTING indicator is lit.
- ➔ The protective device on the receiver has been activated because of a short circuit. Turn off the receiver, eliminate the short-circuit problem and turn on the power again.

### **The left and right sounds are unbalanced or reversed.**

- ➔ Check that the speakers and components are connected correctly and securely.
- ➔ Adjust front balance parameter in the LEVEL menu.

### **Severe hum or noise is heard.**

- ➔ Check that the speakers and components are connected securely.
- ➔ Check that the connecting cords are away from a transformer or motor, and at least 10 feet (3 meters) away from a TV set or fluorescent light.
- ➔ Move your TV away from the audio components.
- ➔ The plugs and jacks are dirty. Wipe them with a cloth slightly moistened with alcohol.

### **No sound is heard from the center speaker.**

- ➔ Make sure the sound field function is on (press SOUND FIELD – MODE).
- ➔ Select a sound field containing the word “cinema” or “virtual” (see pages 28 – 30).
- ➔ Adjust the speaker volume (see page 19).
- ➔ Make sure the center speaker size parameter is set to either SMALL or LARGE (see page 17).

## Troubleshooting

### No sound or only a very low-level sound is heard from the rear speakers.

- ➔ Make sure the sound field function is on (press SOUND FIELD – MODE).
- ➔ Select a sound field containing the word “cinema” or “virtual” (see pages 28–30).
- ➔ Adjust the speaker volume (see page 19).
- ➔ Make sure the rear speaker size parameter is set to either SMALL or LARGE (see page 17).

### No sound is heard from the sub woofer.

- ➔ Make sure the sub woofer is set to ON (see page 18).

### Recording cannot be done.

- ➔ Check that the components are connected correctly.
- ➔ Select the source component with a FUNCTION button.
- ➔ When recording from a digital component, make sure the input mode is set to ANALOG (see page 23) before recording with a component connected to the analog MD/TAPE terminals.

### Radio stations cannot be tuned in.

- ➔ Check that the antennas are connected securely. Adjust the antennas and connect an external antenna if necessary.
- ➔ The signal strength of the stations is too weak (when tuning in with automatic tuning). Use direct tuning.
- ➔ Make sure you set the tuning interval correctly (when tuning in AM stations with direct tuning) (see pages 39 and 48).
- ➔ No stations have been preset or the preset stations have been cleared (when tuning by scanning preset stations). Preset the stations (see page 40).
- ➔ Press DISPLAY so that the frequency appears in the display.

### The surround effect cannot be obtained.

- ➔ Make sure the sound field function is on (press SOUND FIELD – MODE).
- ➔ Make sure that the SPEAKERS selector is set to A or B (not A+B) if you connected two sets of front speakers (STR-DE545 and STR-SE501 only).

### “PCM--kHz” appears on the display.

- ➔ The sampling frequency is more than 48 kHz. Change the DVD setting to 48 kHz.

### Nothing appears on the display.

- ➔ When the display turns off immediately after the receiver is turned on, press DIMMER to change the display mode.

### No picture or an unclear picture appears on the TV screen or monitor.

- ➔ Select the appropriate function on the receiver.
- ➔ Set your TV to the appropriate input mode.
- ➔ Move your TV away from the audio components.

### The remote does not function.

- ➔ Point the remote at the remote sensor  on the receiver.
- ➔ Remove any obstacles in the path between the remote and the receiver.
- ➔ Replace both batteries in the remote with new ones, if they are weak.
- ➔ Make sure you select the correct function on the remote.
- ➔ If the remote is set to operate the TV only, use the remote to select a source or component other than TV before operating the receiver or other component.

### Reference sections for clearing the receiver's memory

To clear	See
All memorized settings	page 15
Customized sound fields	page 35

# Specifications

## AUDIO POWER SPECIFICATIONS

### POWER OUTPUT AND TOTAL HARMONIC DISTORTION:

With 8 ohm loads, both channels driven, from 20 - 20,000 Hz; rated 100<sup>a)</sup> watts per channel minimum RMS power, with no more than 0.09% total harmonic distortion from 250 milliwatts to rated output (USA model only).

**STR-DE445:**  
a) 80 watts

## Amplifier section

### Rated Power Output at Stereo mode

(8 ohms 20 Hz - 20 kHz, THD 0.09%)

STR-DE545/SE501  
100 W + 100 W

STR-DE445:  
80 W + 80 W

### Reference Power Output

(8 ohms at 1 kHz, THD 0.7%)

STR-DE545/SE501:  
Front: 100 W + 100 W  
Center: 100 W  
Rear: 100 W + 100 W

STR-DE445:  
Front: 80 W + 80 W  
Center: 80 W  
Rear: 80 W + 80 W

### Frequency response

CD, MD/TAPE, DVD/LD, TV/SAT, VIDEO, AUX:  
10 Hz - 50 kHz +0.5/-2 dB (with sound field, tone, and bass boost bypassed)

### Inputs (Analog)

5.1 CH INPUT, CD, DVD/LD, MD/TAPE, TV/SAT, VIDEO, AUX:  
Sensitivity: 250 mV  
Impedance: 50 kilohms  
S/N<sup>b)</sup>: 96 dB (A, 250 mV<sup>c)</sup>)

b) Input short.

c) Weighted network, input level.

### Inputs (Digital)

DVD/LD (coaxial):  
Sensitivity: -  
Impedance: 75 ohms  
S/N: 100 dB (A, 20 kHz LPF)  
DVD/LD, TV/SAT\* (Optical):  
Sensitivity: -  
Impedance: -  
S/N: 100 dB (A, 20 kHz LPF)

\*) STR-DE545 and STR-SE501 only.

### Outputs

MD/TAPE, (REC OUT); VIDEO (AUDIO OUT):  
Voltage: 250 mV, Impedance: 10 kilohms  
SUB WOOFER:  
Voltage: 2 V  
Impedance: 1 kilohms  
PHONES:  
Accepts low- and high-impedance headphones

**BASS BOOST** +6 dB at 70 Hz

**TONE** ±6 dB at 100 Hz and 10 kHz

### Sampling Frequency

48 kHz

## Specifications

### FM tuner section

<b>Tuning range</b>	87.5 - 108.0 MHz
<b>Antenna terminals</b>	75 ohms, unbalanced
<b>Sensitivity</b>	Mono: 18.3 dBf, 2.2 $\mu$ V/75 ohms Stereo: 38.3 dBf 22.5 $\mu$ V/75 ohms
<b>Usable sensitivity</b>	11.2 dBf, 1 $\mu$ V/75 ohms
<b>S/N</b>	Mono: 76 dB Stereo: 70 dB
<b>Harmonic distortion at 1 kHz</b>	Mono: 0.3% Stereo: 0.5%
<b>Separation</b>	45 dB at 1 kHz
<b>Frequency response</b>	30 Hz - 15 kHz +0.5/-2 dB
<b>Selectivity</b>	60 dB at 400 kHz

### AM tuner section

<b>Tuning range</b>	With 10-kHz tuning scale: 530 - 1710 kHz <sup>d</sup> With 9-kHz tuning scale: 531 - 1710 kHz <sup>d</sup>
<b>Antenna</b>	Loop antenna
<b>Usable sensitivity</b>	50 dB/m (at 1,000 kHz or 999 kHz)
<b>S/N</b>	54 dB (at 50 mV/m)
<b>Harmonic distortion</b>	0.5 % (50 mV/m, 400 kHz)
<b>Selectivity</b>	At 9 kHz: 35 dB At 10 kHz: 40 dB

*d) You can change the AM tuning interval to 9 kHz. After tuning in any AM station, turn off the receiver. Hold down the TUNING + button and press the V/⏏ button. All preset stations will be erased when you change the tuning interval. To reset the scale to 10 kHz, repeat the procedure.*

### Video section

<b>Inputs</b>	Video: 1 Vp-p 75 ohms S-video*: Y: 1 Vp-p 75 ohms C: 0.286 Vp-p 75 ohms
<b>Outputs</b>	Video: 1 Vp-p 75 ohms S-video*: Y: 1 Vp-p 75 ohms C: 0.286 Vp-p 75 ohms

\* STR-DE545 and STR-SE501 only.

### General

<b>System</b>	Tuner section: PLL quartz-locked digital synthesizer system Preamplifier section: Low-noise NF type equalizer Power amplifier section: Pure-complementary SEPP
<b>Power requirements</b>	120 V AC, 60 Hz
<b>Power consumption</b>	STR-DE545/SE501: 190 W STR-DE445: 185 W
<b>AC outlets (STR-DE545 and STR-SE501 only)</b>	1 switched, total 120 W/1A Max
<b>Dimensions</b>	430 × 303 × 157 mm (17 × 12 × 6 <sup>1</sup> / <sub>4</sub> in.) including projecting parts and controls
<b>Mass (Approx.)</b>	STR-DE545: 7.9 kg (17 lbs. 7 oz.) STR-DE445: 7.7 kg (16 lbs. 16 oz.) STR-SE501: 8.2 kg (18 lbs. 2 oz.)
<b>Supplied accessories</b>	See page 4.

Design and specifications are subject to change without notice.



# Glossary

## Surround sound

Sound that consists of three elements: direct sound, early reflected sound (early reflections) and reverberative sound (reverberation). The acoustics of the surrounding space affect the way these three sound elements are heard. Surround sound combines these sound elements in such a way that you actually can sense the size of the venue, as well as its type.

### • Types of sound

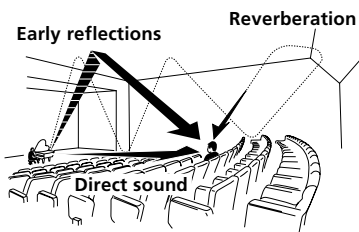

### • Transition of sound from rear speakers

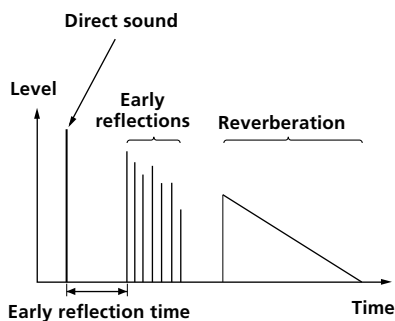

## Dolby Pro Logic Surround

As one method of decoding Dolby Surround, Dolby Pro Logic Surround produces four channels from two-channel sound. Compared with the former Dolby Surround system, Dolby Pro Logic Surround reproduces left-to-right panning more naturally and localizes sounds more precisely. To take full advantage of Dolby Pro Logic Surround, you should have one pair of rear speakers and a center speaker. The rear speakers output monaural sound.

## Dolby Digital (AC-3)

This sound format for movie theaters is more advanced than Dolby Pro Logic Surround. In this format, the rear speakers output stereo sound with an expanded frequency range and a sub woofer channel for deep bass is independently provided. This format is also called "5.1" because the sub woofer channel is counted as 0.1 channel (since it functions only when a deep bass effect is needed). All six channels in this format are recorded separately to realize superior channel separation. Furthermore, since all the signals are processed digitally, less signal degradation occurs. The name "AC-3" comes from the fact that it is the third audio coding method to be developed by the Dolby Laboratories Licensing Corporation.

## Digital Cinema Sound

This is the generic name of the surround sound produced by digital signal processing technology developed by Sony. Unlike previous surround sound fields mainly directed at the reproduction of music, Digital Cinema Sound is designed specifically for the enjoyment of movies.

# Settings Using SUR, LEVEL, BASS/TREBLE, and SET UP buttons

You can make various settings using the LEVEL, SUR, BASS/TREBLE, SET UP buttons, cursor buttons and jog dial. The table below shows each of the settings that these buttons can make.

Press and light	Press < or > to select	Turn jog dial to select	See page
SUR button	EFFECT LEVEL	depends on sound mode (in 16 steps)	33
	WALL TYPE	between -8 to +8 (in 1 increment steps)	
	REVERBERATION TIME	-8 to +8 (in 1 increment steps)	
LEVEL button	FRONT BALANCE	between -8 to +8 (in 1 increment steps)	34
	REAR BALANCE	between -8 to +8 (in 1 increment steps)	
	REAR LEVEL	between -10 dB to +6 dB (in 1 dB steps)	
	CENTER LEVEL	between -10 dB to +6 dB (in 1 dB steps)	
	SUB WOOFER LEVEL	between -10 dB to +6 dB (in 1 dB steps)	
	LFE MIX LEVEL	OFF, or -20 dB to 0 dB (in 1 dB steps)	
	dts LFE MIX LEVEL	OFF, or -20 dB to +10 dB (in 1 dB steps)	
	DYNAMIC RANGE COMP	OFF, 0.1 to 0.9 (in 0.1 dB steps), STD, or MAX	
BASS/TREBLE button	BASS	between -6 dB to +6 dB (2 dB step)	35
	TREBLE	between -6 dB to +6 dB (2 dB step)	
*SET UP	[L] [R] (FRONT)	LARGE or SMALL	16
	[C] (CENTER)	LARGE, SMALL, or NO	
	[LS] [RS] (REAR)	LARGE, SMALL, or NO	
	REAR PL.	PL. SIDE or PL. BEHD.	
	REAR HGT.	HGT. LOW or HGT. HIGH	
	SUB WOOFER	S.W. YES or S.W. NO	
	[L] [R] (FRONT) XX.X FEET	between 3 feet (1.0 meters) and 40 feet (12.0 meters) (in 1 foot (0.1 meter) steps)	
	[C] (CENTER) XX.X FEET	between FRONT and 5 feet (1.5 meters) (in 1 foot (0.1 meter) steps)	
	[LS] [RS] (REAR) XX.X FEET	between FRONT and 15 feet (4.5 meters) (in 1 foot (0.1 meter) steps)	
	5.1 V.IN [XXX]	V-TV/SAT, V-DVD/LD, V-VIDEO	

\* When you press the SET UP button, you can select NORM. SP (for normal speakers) or MICRO SP (for Micro Satellite speakers). (page 16)

## Remote Button Description (STR-DE445 only)

You can use the remote to operate the components in your system. The tables below show the settings of each button.

Remote Button	Operations	Function
SLEEP	Receiver	Activates the sleep function and the duration which the receiver turns off automatically.
AV I/⏻	TV/VCR/ CD player/ DVD player/ MD deck/ VCD player/ LD player/ DAT deck	Turns the audio and video components on or off.
I/⏻	Receiver	Turns the receiver on or off.
VIDEO	Receiver	To watch video tapes.
DVD/LD	Receiver	To watch DVD or laser disc.
TV/SAT	Receiver	To watch TV programs or satellite receiver.
MD/TAPE	Receiver	To listen Minidisc or audio tape.
CD	Receiver	To listen to compact disc.
TUNER	Receiver	To listen to radio programs.
AUX	Receiver	To listen to an audio equipment.
5.1CH	Receiver	To watch DVD player or Dolby Digital.
0-9	Receiver	Use with "SHIFT" button to select tuner preset station numeric input during DIRECT TUNING or MEMORY mode.
	CD player/ MD deck/ VCD player/ LD player/ DAT deck	Selects track numbers. 0 selects track 10.
	TV/VCR/SAT	Selects channel numbers.
>10	CD player/ MD deck/ Tape deck/ LD player/ VCD player	Selects tracks numbers over 10.
ENTER	TV/VCR/SAT/ Tape deck/ LD player/ VCD player/ MD deck/ DAT deck	After selectig a channel, disc or track using the numeric buttons, press to enter the value.

Remote Button	Operations	Function
SHIFT	Receiver	Press repeatedly to select a memory page for presetting radio stations or tuning to preset stations.
-/--	TV	Selects the channel entry mode, either one or two digit.
D.TUNING	Receiver	Tuner station direct key-in mode.
⏮/⏭	CD player/ MD deck/ DVD player/ LD player/ VCD player/ Tape deck/VCR/ DAT deck	Skips tracks.
⏪/⏩	CD player/ DVD player/ VCD player	Searches tracks (forward or backward).
	MD deck/ Tape deck/VCR/ LD player/ DAT deck	Fastforwards or rewinds.
◀	Tape deck	Starts play on the reverse side.
▶	CD player/ MD deck/Tape deck/VCR/ DVD player/ VCD player/ LD player/ DAT deck	Starts play.
⏸	CD player/ MD deck/Tape deck/VCR/ DVD player/ VCD player/ LD player/ DAT deck	Pauses play or record. (Also starts recording with components in record standby.)
■	CD player/ MD deck/Tape deck/VCR/ DVD player/ VCD player/ LD player/ DAT deck	Stops play.
POSITION*	TV	Changes the position of the small picture.
SWAP*	TV	Swaps the small and the large picture.
DISC	CD player	Select discs (Mega storage CD player only).

\* Only for Sony TVs with the picture-in-picture function.

## Remote Button Description (STR-DE445 only)

Remote Button	Operations	Function
SUB CH +/-*	TV	Selects preset channels for the small picture.
CH PRESET +/-	Receiver	Scans and selects preset stations.
	TV/VCR/SAT	Selects preset channels.
DISPLAY	TV/VCR/ LD player/ DVD player/ VCD player	Selects information displayed on the TV screen.
P IN P*	TV	Activates the picture-in-picture function.
JUMP	TV	Toggles between the previous and the current channels.
WIDE	TV	Selects the wide picture mode.
D. SKIP	CD player	Skips discs (CD player with multi-disc changer only).
ANT TV/VTR	VCR	Selects output signal from the aerial terminal: TV signal or VCR program.
TV/VIDEO	TV/VCR	Selects input signal: TV input or video input.
A. F. D.	Receiver	Auto Format Decoding.
2CH/OFF	Receiver	Turns off sound field.
MODE	Receiver	Selects sound field mode.
EQ/TONE	Receiver	Turns the tone effect on or off.
BASS BOOST	Receiver	Reinforces bass in front speakers.
MUTING	Receiver	Mutes the sound from the receiver.
TEST TONE	Receiver	Press to output test tone.
CURSOR MODE	Receiver	Press this button repeatedly to select one of the three cursor modes: LEVEL, SURROUND and BASS/TREBLE.
MASTER VOL +/-	Receiver	Adjusts the master volume of the receiver.
MENU </>	Receiver	Selects a menu item.
MENU +/-	Receiver	Makes adjustment or change the setting.
MENU	DVD	Displays DVD menu.
◁/▷/◂/▸	DVD	Selects a menu item.
ENTER	DVD	Enters the selection.

Remote Button	Operations	Function
RETURN	DVD	Returns to the previous menu or exits the menu.
TITLE	DVD	Displays DVD title.

\* Only for Sony TVs with the picture-in-picture function.

### Note

Some Sony equipments cannot be controlled by this remote as shown in the table above.

## Changing the factory setting of a function button

If the factory settings of the FUNCTION buttons don't match your system components, you can change them. For example, if you have two CD players and you don't have a tape deck or an MD recorder, you can assign the MD/TAPE button to your second CD player.

Note that the settings of the TUNER button cannot be changed.

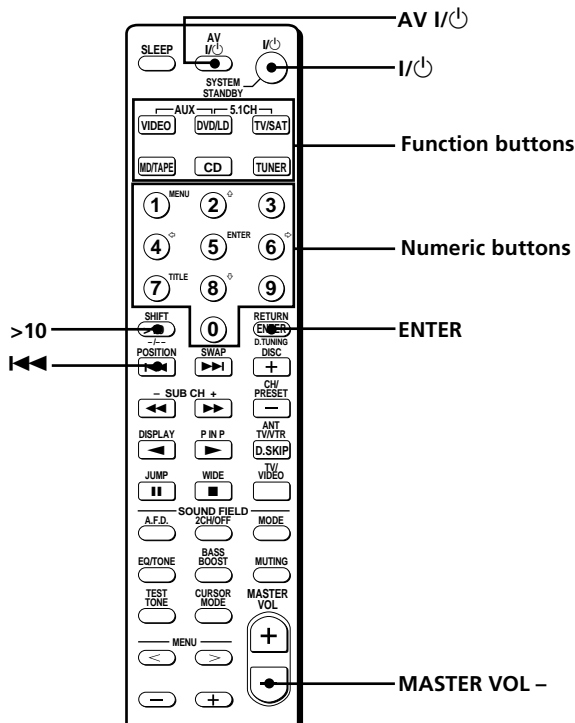

- 1** Hold down the Function button whose function you want to change (for example, MD/TAPE).
- 2** Press the corresponding button of the component you want to assign to the Function button (for example, 1 - CD player).

The following buttons are assigned to select the functions:

To operate	Press
CD player	1
DAT deck	2
MD deck	3
Tape deck A	4
Tape deck B	5
LD player	6
VCR (remote control mode VTR 1*)	7
VCR (remote control mode VTR 2*)	8
VCR (remote control mode VTR 3*)	9
TV	0
DSS (Digital Satellite Receiver)	>10
DVD	ENTER
VCD player	⏪

\* Sony VCRs are operated with a VTR 1, 2 or 3 setting. These correspond to Beta, 8mm and VHS respectively.

Now you can use the MD/TAPE button to control a second CD player.

#### To change the AUX function to another function

Hold down SLEEP and press the corresponding button of the component you want to assign it to.

#### To change the 5.1 CH function to another function

Hold down AV I/⏻ and press the corresponding button of the component you want to assign it to.

#### To reset a button to its factory setting

Repeat the above procedure.

#### To reset all the function buttons to their factory setting

Press I/⏻, AV I/⏻ and MASTER VOL – at the same time.

---

# Index

## A

- AC-3. *See* *Dolby Digital (AC-3)*
- Adjusting
  - brightness of the display 24
  - speaker volumes 19
  - surround parameters 34
- Automatic tuning 39

## B

- Basic receiver operations 22–26
- Batteries 4

## C

- Changing
  - display 24
  - effect level 33
- Checking the connections 20
- Clearing receiver's memory 15
- Connecting. *See* *Hookups*
- CONTROL A1 II 10, 11
- Customizing sound fields 33

## D

- Demonstration mode 3
- Digital Cinema Sound 49
- Direct tuning 39
- Dolby Digital (AC-3) 49
- Dolby Pro Logic Surround 49
- Dubbing. *See* *Recording*

## E, F, G

- Editing. *See* *Recording*
- Effect level 33

## H

- Hookups
  - 5.1CH Input 9
  - AC power cord 11
  - antennas 5
  - audio components 6
  - digital components 8
  - CONTROL A1 II 11
  - speaker system 13
  - video components 7

## I, J, K

- Indexing. *See* *Naming*

## L, M

- Labeling. *See* *Naming*

## N, O

- Naming
  - preset stations 42
  - program sources 42

## P, Q

- Parameter 34, 36
- Preset stations
  - how to preset 40
  - how to tune 40
- Preset tuning 40

## R

- Receiving broadcasts
  - automatically 39
  - directly 39
  - preset stations 40
- Recording
  - on an audio tape or MD 42
  - on a video tape 43

## S

- Scanning
  - preset stations. *See* *Preset tuning*
  - radio stations. *See* *Automatic tuning*
- Selecting
  - component 22
  - front speaker system 23
  - sound field 28
- Sleep timer 43
- Sound field
  - adjustable parameters 34
  - customizing 33
  - pre-programmed 28–30
  - resetting 35
  - selecting 28

## Speakers

- adjusting speaker volume 19
- connection 13
- front speakers (A/B) 23
- impedance 14
- placement 16
- Supplied accessories 4
- Surround sound 16–20, 27–36, 49

## T

- Test tone 19
- Troubleshooting 45
- Tuning
  - automatically 39
  - directly 39
  - preset stations 40

## U, V, W, X, Y, Z

- Unpacking 4

