

FM Stereo FM-AM Receiver

Operating Instructions

Owner's Record

The model and serial numbers are located on the rear panel. Record the serial number in the space provided below. Refer to them whenever you call upon your Sony dealer regarding this product.

Model No. _____ Serial No. _____

STR-SL7

WARNING

To prevent fire or shock hazard, do not expose the unit to rain or moisture.



Don't throw a battery, dispose it as the injurious wastes.

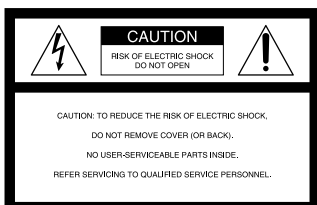

This symbol is intended to alert the user to the presence of uninsulated “dangerous voltage” within the product’s enclosure that may be of sufficient magnitude to constitute a risk of electric shock to persons.



This symbol is intended to alert the user to the presence of important operating and maintenance (servicing) instructions in the literature accompanying the appliance.

WARNING

This equipment has been tested and found to comply with the limits for a Class B digital device, pursuant to Part 15 of the FCC Rules. These limits are designed to provide reasonable protection against harmful interference in a residential installation. This equipment generates, uses, and can radiate radio frequency energy and, if not installed and used in accordance with the instructions, may cause harmful interference to radio communications. However, there is no guarantee that interference will not occur in a particular installation. If this equipment does cause harmful interference to radio or television reception, which can be determined by turning the equipment off and on, the user is encouraged to try to correct the interference by one or more of the following measures:

- Reorient or relocate the receiving antenna.
- Increase the separation between the equipment and receiver.
- Connect the equipment into an outlet on a circuit different from that to which the receiver is connected.
- Consult the dealer or an experienced radio/TV technician for help.

CAUTION

You are cautioned that any changes or modifications not expressly approved in this manual could void your authority to operate this equipment.

Note to CATV system installer

This reminder is provided to call the CATV system installer’s attention to Article 820-40 of the NEC that provides guidelines for proper grounding and, in particular, specifies that the cable ground shall be connected to the grounding system of the building, as close to the point of cable entry as practical.

This receiver incorporates Dolby* Digital and Pro Logic Surround and the DTS** Digital Surround System.

* Manufactured under license from Dolby Laboratories.

“Dolby”, “Pro Logic” and the double-D symbol are trademarks of Dolby Laboratories.

** “DTS” and “DTS Digital Surround” are registered trademarks of Digital Theater Systems, Inc.

Tip

The instructions in this manual describe the controls on the receiver. You can also use the controls on the supplied remote if they have the same or similar names as those on the receiver. For details on the use of your remote, see pages 33–36.

Demonstration Mode

The demonstration will activate the first time you turn on the power. When the demonstration starts, the following message appears in the display twice:

“NOW DEMONSTRATION MODE IF YOU FINISH DEMONSTRATION PLEASE PRESS POWER KEY WHILE THIS MESSAGE APPEARS IN THE DISPLAY THANK YOU”

To cancel the demonstration

Press I/⏻ to turn the receiver off during the previous message. The next time you turn the receiver on, the demonstration will not appear.

To view the demonstration

Hold down SET UP and press I/⏻ to turn on the power.

Notes

- Running the demonstration will clear the receiver’s memory. For details on what will be cleared, see “Clearing the receiver’s memory” on page 13.
- There will be no sound when the demonstration mode is activated.
- You cannot cancel demonstration if you did not press I/⏻ while the above message is being displayed. To cancel demonstration after the above message appears, press I/⏻ twice to activate the demonstration again. Then, press I/⏻ while the above message is being displayed.

Table of Contents

Parts Identification

Main unit	4
-----------------	---

Hooking Up the Components

Required cords	5
Antenna hookups	6
Video component hookups	7
Digital component hookups	8
Multi channel input hookups	9
Other hookups	10

Hooking Up and Setting Up the Speaker System

Speaker system hookups	11
Performing initial setup operations	13
Multi channel surround setup	13
Checking the connections	18

Basic Operations

Selecting the component	18
-------------------------------	----

Enjoying Surround Sound

Selecting a sound field	19
Understanding the multi channel surround displays	21
Customizing sound fields	22

Receiving Broadcasts

Manual memory	24
Automatic memory	24
Tuning to preset stations	25
Automatic tuning	25
Direct tuning	25

Other Operations

Using the Sleep Timer	26
Adjustments using the SET UP button ...	26

Additional Information

Precautions	27
Troubleshooting	27
Specifications	29
Tables of settings using LEVEL/SURR and SET UP buttons	31
Adjustable parameters for each sound field	32
Before you use your remote	33
Remote button description	33
Changing the factory setting of a function button	Back cover

The items are arranged in alphabetical order.

Refer to the pages indicated in parentheses () for details.

Main unit

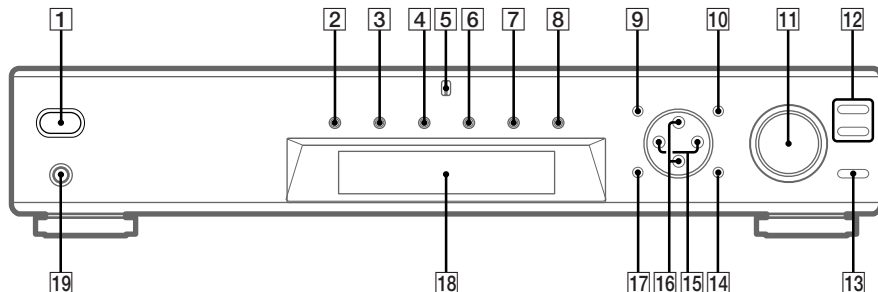

AUX **[6]** (18)

Cursor buttons (▲/▼) **[16]** (14, 22–26)

Display **[18]** (21)

DVD **[3]** (18)

LEVEL/SURR **[17]** (22, 23)

MASTER VOLUME **[11]** (17, 18)

MEMORY/ENTER **[14]** (24)

MULTI CH IN **[8]** (18)

MULTI CHANNEL DECODING
indicator **[5]**

MUTING **[13]** (18)

PHONES jack **[19]** (18)

SET UP **[10]** (14, 26)

SOUND FIELD +/- **[12]** (19, 23)

TUNER **[9]** (25)

TUNER FM/AM **[7]** (18, 24, 25)

TV **[4]** (18)

VIDEO **[2]** (18)

I/O (power) **[1]** (13, 17, 18, 23)

+/- **[15]** (14, 22–26)

Required cords

Before you get started

- Turn off the power to all components before making any connections.
- Do not connect the AC power cord until all of the connections are completed.
- Be sure to make connections firmly to avoid hum and noise.
- When connecting optical digital cords, take the caps off the connectors and insert the cord plugs straight in until they click into place.
- Do not bend or tie the optical digital cord.

A Audio cord (not supplied)

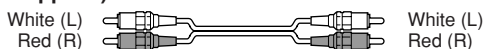

B S-video cord (not supplied)



C Optical digital cord (not supplied)



D Coaxial digital cord (supplied)



E Monaural audio cord (not supplied)



Antenna hookups

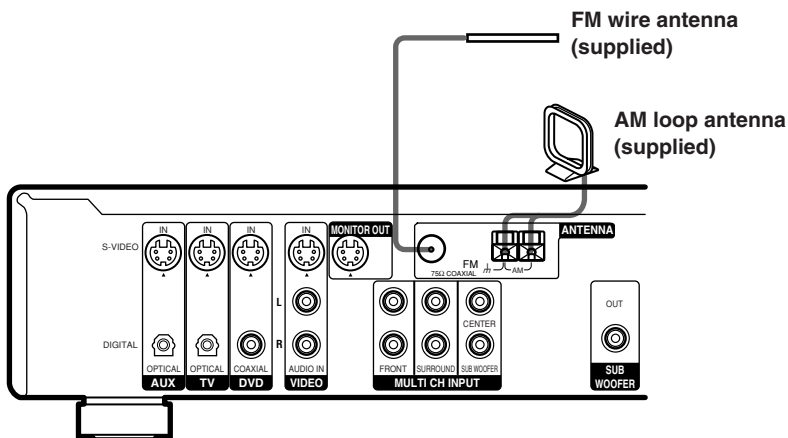

Notes on antenna hookups

- To prevent noise pickup, keep the AM loop antenna away from the receiver and other components.
- Be sure to fully extend the FM wire antenna.
- After connecting the FM wire antenna, keep it as horizontal as possible.
- Do not use the \hbar SIGNAL GND terminal for grounding the receiver.

Video component hookups

For details on the required cords (A – E), see page 5.

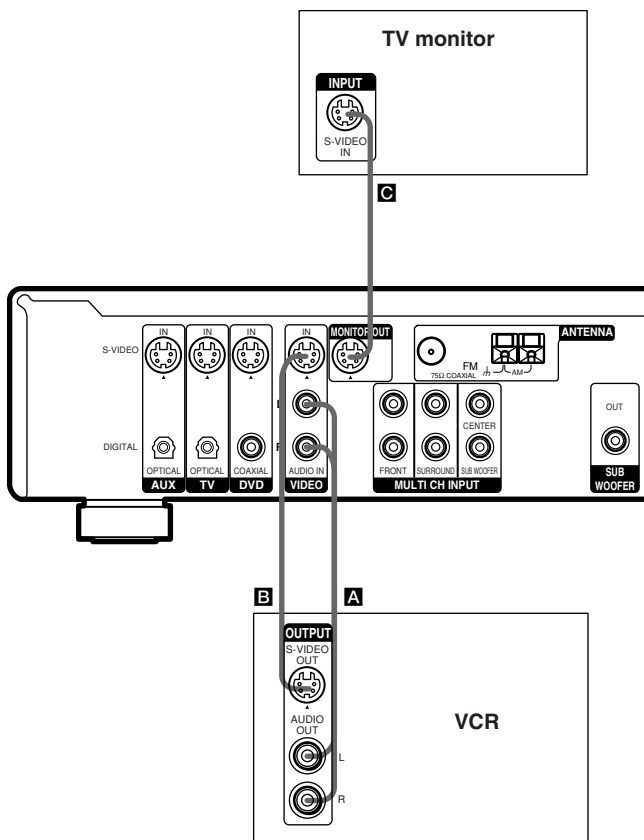

To apply sound effects to the audio from the TV

You can connect your TV's audio output jacks to the VIDEO AUDIO IN jacks on the receiver and apply sound effects to the audio from the TV. In this case, do not connect the TV's video output jack to the VIDEO IN jack on the receiver.

To adjust the volume of TV using the remote, assign the VIDEO button to TV (back cover).

Digital component hookups

Connect the digital output jacks of your DVD player (etc.) to the receiver's digital input jacks to bring the multi channel surround sound of a movie theater into your home. To fully enjoy multi channel surround sound, five speakers (two front speakers, two surround speakers, and a center speaker) and a sub woofer are required.

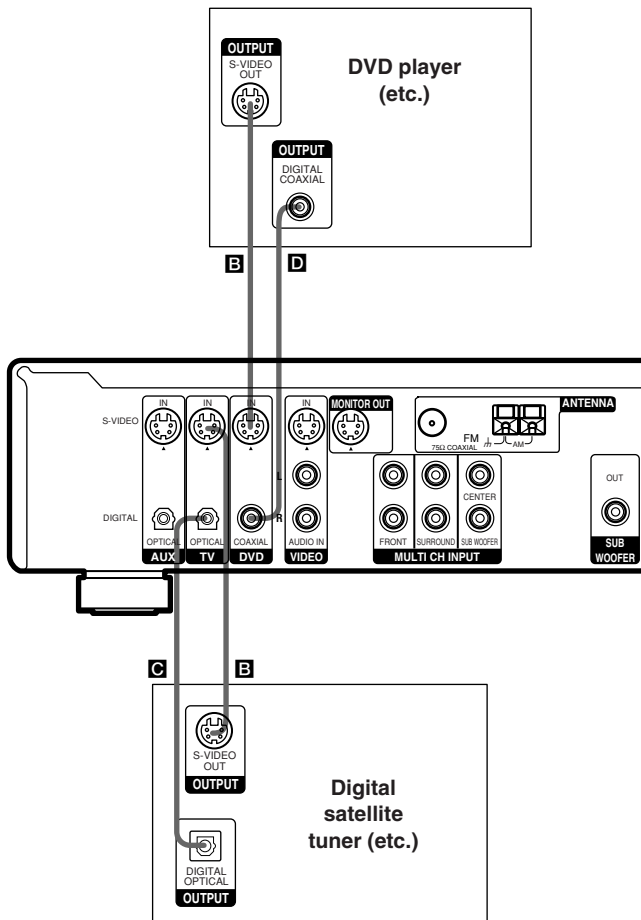

Notes

- The OPTICAL input jacks are compatible with 48 kHz, 44.1 kHz and 32 kHz sampling frequencies.
- The COAXIAL input jack is compatible with 96 kHz, 48 kHz, 44.1 kHz and 32 kHz sampling frequencies.

Multi channel input hookups

Although this receiver incorporates a multi channel decoder, it is also equipped with multi channel input jacks. These connections allow you to enjoy multi channel software encoded in formats other than Dolby Digital and DTS. If your DVD player is equipped with multi channel output jacks, you can connect them directly to the receiver to enjoy the sound of the DVD player's multi channel decoder. Alternatively, the multi channel input jacks can be used to connect an external multi channel decoder.

To fully enjoy multi channel surround sound, five speakers (two front speakers, two surround speakers, and a center speaker) and a sub woofer are required. Refer to the operating instructions supplied with your DVD player, multi channel decoder, etc., for details on the multi channel hookups.

Tips

- To specify the video input to be used with the audio signals from the MULTI CH INPUT jacks, set the MULTI CH IN visual input in the SET UP menu (page 26).
- You can use cord **A** instead of 2 cords **E**.

Notes

- When using the connections described below, adjust the level of the surround speakers and sub woofer from the DVD player or multi channel decoder.
- See page 11 for details on speaker system hookup.

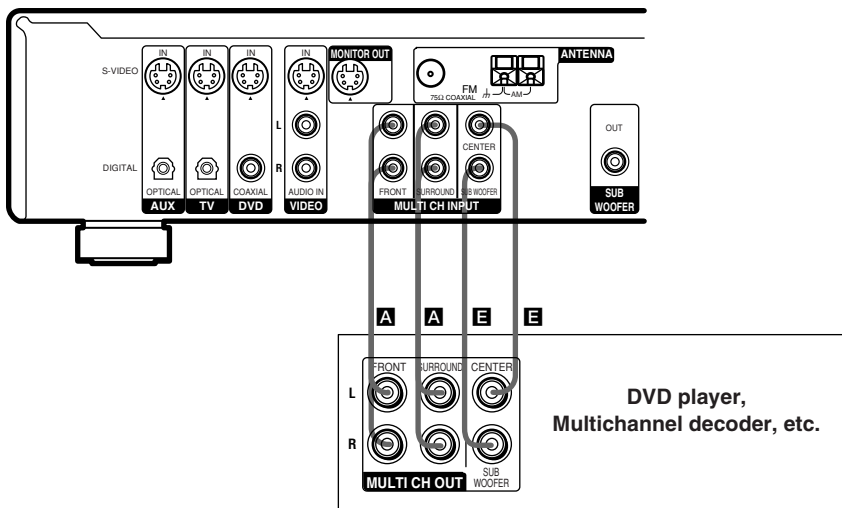

Other hookups

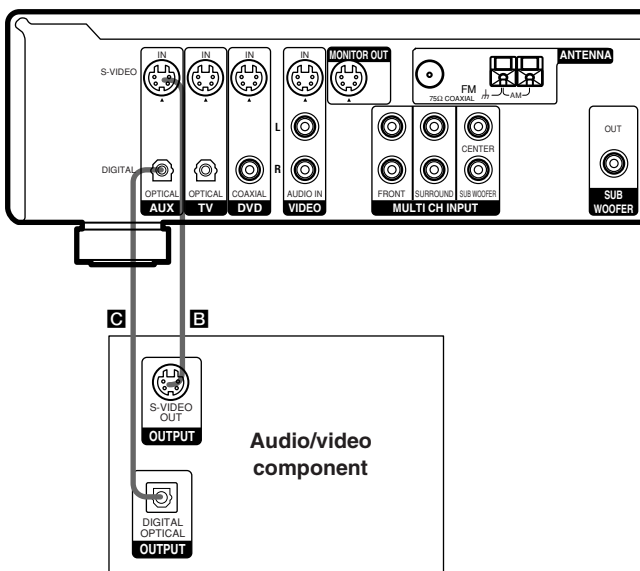

AUX hookups

If you have an individual audio/video component

Use an optical digital cord (not supplied) to connect the optical output jack on the CD player, MD deck, or video game player to the AUX OPTICAL jack on the receiver so that you can listen to stereo sources in surround sound.

Use the S-video cable (not supplied) to connect the S-video output jack on your video component to the AUX S-VIDEO IN jack on the receiver.

Connecting the AC power cord

Before connecting the AC power cord of this receiver to a wall outlet, connect the speaker system to the receiver (see page 11).

Connect the AC power cord(s) of your audio/video components to a wall outlet.

Note

If the AC power cord is disconnected for about two weeks, the receiver's entire memory will be cleared and the demonstration will start.

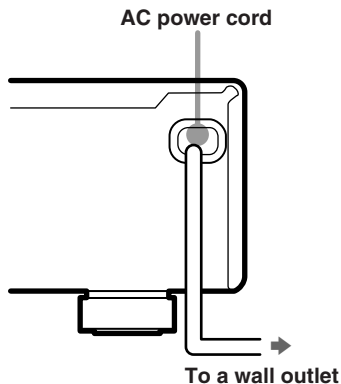

Speaker system hookups

Before connecting speakers, be sure to turn off this unit.

Required cords

A Speaker cords (not supplied)



B Monaural audio cord (not supplied)

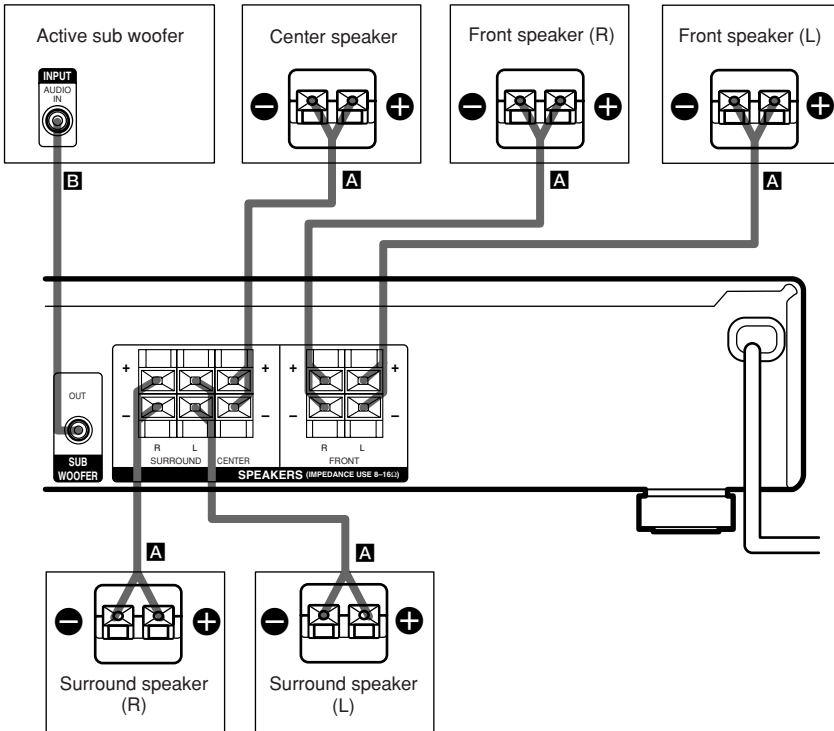

continued

Speaker system hookups (continued)

To avoid short-circuiting the speakers

Short-circuiting of the speakers may damage the receiver. To prevent this, make sure to take the following precautions when connecting the speakers.

Make sure the stripped ends of each speaker cord does not touch another speaker terminal or the stripped end of another speaker cord.

Examples of poor conditions of the speaker cord

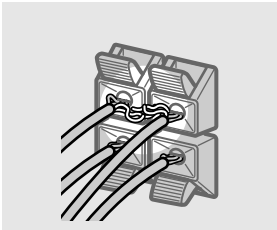

Stripped speaker cord is touching another speaker terminal.

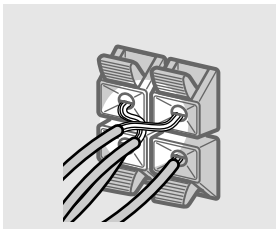

Stripped cords are touching each other due to excessive removal of insulation.

After connecting all the components, speakers, and AC power cord, output a test tone to check that all the speakers are connected correctly. For details on outputting a test tone, see page 17.

If no sound is heard from a speaker while outputting a test tone or a test tone is output from a speaker other than the one whose name is currently displayed on the receiver, the speaker may be short-circuited. If this happens, check the speaker connection again.

To avoid damaging your speakers

Make sure that you turn down the volume before you turn off the receiver. When you turn on the receiver, the volume remains at the level you turn off the receiver.

Performing initial setup operations

Once you have hooked up the speakers and turned on the power, clear the receiver's memory. Then specify the speaker parameters (size, position, etc.) and perform any other initial setup operations necessary for your system.

Tip

To check the audio output during settings (to set up while outputting the sound), check the connection (see page 18).

Clearing the receiver's memory

Before using your receiver for the first time, or when you want to clear the receiver's memory, do the following.

This procedure is not necessary if the demonstration activates when you turn on the power.

1 Turn off the receiver.

2 Hold down I/⏻ for 5 seconds.

The demonstration starts (see page 2) and all of the following items are reset or cleared:

- All sound field parameters are reset to their factory settings.
- All SET UP parameters are reset to their factory settings.
- The sound fields memorized for each program source and preset stations are cleared.
- The master volume is set to "MIN".

Performing initial setup operations

Before using your receiver for the first time, adjust SET UP parameters so that the receiver correspond to your system. For the adjustable parameters, see the table on page 31. See pages 13–17 for speaker settings and page 26 for other settings.

Multi channel surround setup

For the best possible surround sound, all speakers should be the same distance from the listening position (A).

However, the receiver lets you to place the center speaker up to 5 feet closer (B) and the surround speakers up to 15 feet closer (C) to the listening position.

The front speakers can be placed from 3 to 40 feet from the listening position (A).

You can place the surround speakers either behind you or to the side, depending on the shape of your room (etc.).

When placing surround speakers to your side

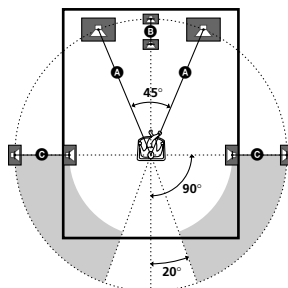

When placing surround speakers behind you

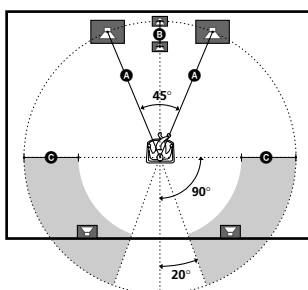

Note

Do not place the center speaker farther away from the listening position than the front speakers.

continued

Multi channel surround setup (continued)

Specifying the speaker parameters

1 Press SET UP.















2 Press the cursor buttons (▲ or ▼) to select the parameter you want to adjust.

3 Press + or – to select the setting you want.

The setting is stored automatically.

4 Repeat steps 2 to 3 until you have set all of the parameters that follow.

Initial settings

Parameter	Initial setting
  (FRONT)	LARGE
 (CENTER)	LARGE
  (SURR)	LARGE
 (SUB WOOFER)	S.W. YES
  (FRONT) XX.X m	DIST. 16 feet
 (CENTER) XX.X m	DIST. 16 feet
  (SURR) XX.X m	DIST. 11 feet
  (SURR) PL. XXX	PL. BEHD.
  (SURR) HGT. XXX	HGT. LOW

Tips for the speaker settings

When you use micro satellite speaker system, you can easily adjust the settings for the speaker size and sub woofer selection. Turn off the power, then turn on again while pressing the cursor button ▲. “MICRO SP.” appears in the display and the speaker size and the sub woofer selection are fixed to the following settings.

Speakers	Settings
Front	SMALL
Center	SMALL
Surround	SMALL
Sub woofer	S.W. YES

You cannot change the configuration if you choose MICRO SP.

To reset to the normal settings, turn off the power, then turn on again while pressing the cursor button ▲.

■ Front speaker size (

- If you connect large speakers that will effectively reproduce bass frequencies, select “LARGE”.
- If the sound is distorted, or you feel a lack of surround effects when using multi channel surround sound, select “SMALL” to activate the bass redirection circuitry and output the front channel bass frequencies from the sub woofer.
- When the front speakers are set to “SMALL”, the center and surround speakers are also automatically set to “SMALL” (unless previously set to “NO”).

■ Center speaker size (

- If you connect a large speaker that will effectively reproduce bass frequencies, select “LARGE”. However, if the front speakers are set to “SMALL”, you cannot set the center speaker to “LARGE”.
- If the sound is distorted, or you feel a lack of surround effects when using multi channel surround sound, select “SMALL” to activate the bass redirection circuitry and output the center channel bass frequencies from the front speakers (if set to “LARGE”) or sub woofer.*1
- If you do not connect a center speaker, select “NO”. The sound of the center channel will be output from the front speakers.*2

■ **Surround speaker size** ( )

- If you connect large speakers that will effectively reproduce bass frequencies, select “LARGE”. However, if the front speakers are set to “SMALL”, you cannot set the surround speakers to “LARGE”.
- If the sound is distorted, or you feel a lack of surround effects when using multi channel surround sound, select “SMALL” to activate the bass redirection circuitry and output the surround channel bass frequencies from the sub woofer or other “LARGE” speakers.
- If you do not connect surround speakers, select “NO”. *3

Tip

*1-~*3 correspond to the following Dolby Pro Logic modes

- *1 NORMAL
- *2 PHANTOM
- *3 3 STEREO

Tip

Internally, the LARGE and SMALL settings for each speaker determine whether or not the internal sound processor will cut the bass signal from that channel. When the bass is cut from a channel, the bass redirection circuitry sends the corresponding bass frequencies to the sub woofer or other “LARGE” speakers.

However, since bass sounds have a certain amount of directionality, it best not to cut them, if possible. Therefore, even when using small speakers, you can set them to “LARGE” if you want to output the bass frequencies from that speaker. On the other hand, if you are using a large speaker, but prefer not to have bass frequencies output from that speaker, set it to “SMALL”.

If the overall sound level is lower than you prefer, set all speakers to “LARGE”.

■ **Sub woofer selection** ()

- If you connect a sub woofer, select “S.W. YES”.
- If you do not connect a sub woofer, select “S.W. NO”. This activates the bass redirection circuitry and outputs the LFE signals from other speakers.
- In order to take full advantage of the Dolby Digital bass redirection circuitry, we recommend setting the sub woofer’s cut off frequency as high as possible.

■ **Front speaker distance** ( )

Set the distance from your listening position to the front speakers (**A** on page 13).

■ **Center speaker distance** ()

Set the distance from your listening position to the center speaker. Center speaker distance should be set from a distance equal to the front speaker distance (**A** on page 13) to a distance 5 feet closer to your listening position (**B** on page 13).

■ **Surround speaker distance** ( )

Set the distance from your listening position to the surround speakers. Surround speaker distance should be set from a distance equal to the front speaker distance (**A** on page 13) to a distance 15 feet closer to your listening position (**C** on page 13).

continued

Multi channel surround setup (continued)

Tip

The receiver allows you to input the speaker position in terms of distance. However, it is not possible to set the center speaker further than the front speakers.

Also, the center speaker cannot be set more than 5 feet closer than the front speakers.

Likewise, the surround speakers can not be set farther away from the listening position than the front speakers. And they can be no more than 15 feet closer.

This is because incorrect speaker placement is not conducive to the enjoyment of surround sound.

Please note that, setting the speaker distance closer than the actual location of the speakers will cause a delay in the output of the sound from that speaker. In other words, the speaker will sound like it is farther away.

For example, setting the center speaker distance 3~6 feet closer than the actual speaker position will create a fairly realistic sensation of being “inside” the screen. If you cannot obtain a satisfactory surround effect because the surround speakers are too close, setting the surround speaker distance closer (shorter) than the actual distance will create a larger sound stage.

Adjusting these parameter while listening to the sound often results in much better surround sound. Give it a try!

■ Surround speaker position ()*

This parameter lets you specify the location of your surround speakers for proper implementation of the Digital Cinema Sound surround modes in the “VIRTUAL” sound fields. Refer to the illustration below.

- Select “PL. SIDE” if the location of your surround speakers corresponds to section **A**.
- Select “PL. BEHD.” if the location of your surround speakers corresponds to section **B**.

This setting only effects the surround modes in the “VIRTUAL” sound fields.

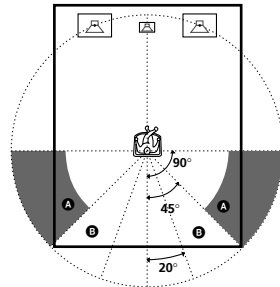

■ Surround speaker height ()*

This parameter lets you specify the height of your surround speakers for proper implementation of the Digital Cinema Sound surround modes in the “VIRTUAL” sound fields. Refer to the illustration below.

- Select “HGT. LOW” if the location of your surround speakers corresponds to section **A**.
- Select “HGT. HIGH” if the location of your surround speakers corresponds to section **B**.

This setting only effects the surround modes in the “VIRTUAL” sound fields.

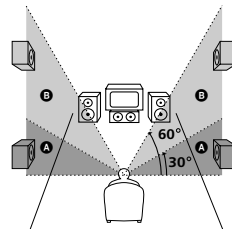

* These parameters are not available when “Surround speaker size” is set to “NO”.

Tip

The surround speaker position parameter is designed specifically for implementation of the Digital Cinema Sound modes in the “VIRTUAL” sound fields.

With the Digital Cinema Sound modes, speaker position is not as critical as other modes. All of the modes in the “VIRTUAL” sound fields were designed under the premise that the surround speaker would be located behind the listening position, but presentation remains fairly consistent even with the surround speakers positioned at a rather wide angle. However, if the speakers are pointing toward the listener from the immediate left and right of the listening position, the “VIRTUAL” sound fields will not be effective unless the surround speaker position parameter is set to “PL. SIDE”.

Nevertheless, each listening environment has many variables, like wall reflections, and you may obtain better results using “PL. BEHD.” if your speakers are located high above the listening position, even if they are to the immediate left and right.

Therefore, although it may result in a setting contrary to the “Surround speaker position” explanation, we recommend that you playback multi channel surround encoded software and listen to the effect each setting has on your listening environment. Choose the setting that provides a good sense of spaciousness and that best succeeds in forming a cohesive space between the surround sound from the surround speakers and the sound of the front speakers. If you are not sure which sounds best, select “PL. BEHD.” and then use the speaker distance parameter and speaker level adjustments to obtain proper balance.

Adjusting the speaker level

Use the remote while seated in your listening position to adjust the level of each speaker.

Note

The receiver incorporates a new test tone with a frequency centered at 800 Hz for easier speaker level adjustment.

1 Press I/⏻ to turn on the receiver.

2 Press TEST TONE on the remote.

You will hear the test tone from each speaker in sequence.

3 Adjust the level parameters so that the level of the test tone from each speaker sounds the same when you are in your main listening position.

To adjust the balance and level of speakers, press MENU </> on the remote to select the level parameter you want to adjust (page 22). Then press MENU +/- to select the setting.

4 Press TEST TONE again to turn off the test tone.

Tip

You can adjust the level of all speakers at the same time. Turn MASTER VOLUME on the main unit or press MASTER VOL +/- on the remote.

Notes

- The adjusted value are shown in the display during adjustment.
- Although these adjustments can also be made via the front panel using the LEVEL menu (when the test tone is output, the receiver switches to the LEVEL menu automatically), we recommend you follow the procedure described above and adjust the speaker levels from your listening position using the remote.

Checking the connections

After connecting all of your components to the receiver, do the following to verify that the connections were made correctly.

- 1** Press I/⏻ to turn on the receiver.
- 2** Press a function button to select a component (program source) that you connected (e.g., DVD player).
- 3** Turn on the component and start playing it.
- 4** Rotate MASTER VOLUME to turn up the volume.

If you do not obtain normal sound output after performing this procedure, see “Troubleshooting” on page 27 and take the appropriate measures to correct the problem.

Selecting the component

Function buttons

Press a function button to select the component you want to use.

To select	Press
VCR	VIDEO
DVD player	DVD
Digital satellite tuner (etc.)	TV
Tuner	TUNER FM/AM
An audio/video component	AUX

After turning on the component you selected, select the component and play the program source.

MULTI CH IN

Press MULTI CH IN to enjoy the audio source connected to the MULTI CH INPUT jacks with the video from the selected component.

- When the MULTI CH IN is selected, the sound field and surround parameters do not function.

MUTING

Press MUTING to mute the sound. MUTING appears on the display when the sound is muted. The muting function is canceled when turning the power off, or disconnecting the power cord.

PHONES

Use the PHONES jack to connect headphones.

- When the headphones are connected, speaker output is automatically cancelled.

You can take advantage of surround sound simply by selecting one of the receiver's pre-programmed sound fields. They bring the exciting and powerful sound of movie theaters and concert halls into your home. You can also customize the sound fields to obtain the sound you want by changing the various surround parameters.

To fully enjoy surround sound, you must register the number and location of your speakers. See "Multi channel surround setup" starting from page 13 to set the speaker parameters before enjoying surround sound.

Selecting a sound field

You can enjoy surround sound simply by selecting one of the pre-programmed sound fields according to the program you want to listen to.

Press SOUND FIELD +/- repeatedly to select the sound field you want.

The current sound field is indicated in the display. See pages 19–20 for information on each sound field.

To turn the surround effect off

Select A.F.D. or 2CH ST. (page 20).

Tips

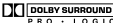
- The receiver memorizes the last sound field selected for each program source (Sound Field Link). Whenever you select a program source, the sound field that was last applied is automatically applied again. For example, if you listen to DVD with HALL as the sound field, change to a different program source, then return to DVD, HALL will be applied again.
- You can identify the encoding format of program software by looking at its packaging. Dolby Digital discs are labeled with the  logo, and Dolby Surround encoded programs are labeled with the  logo.

About DCS (Digital Cinema Sound)

DCS is the concept name of the surround technology for home theater developed by Sony. DCS uses the DSP (Digital Signal Processor) technology to reproduce the sound characteristics of an actual cinema cutting studio in Hollywood.

When played at home, DCS will create a powerful theater effect that mimics the artistic combination of sound and action as envisioned by the movie director.

■ NORM.SURR. (Normal Surround)

Software with multi channel surround audio signals is played back according to the way it was recorded. Software with 2 channel audio signals is decoded with Dolby Pro Logic to create surround effects.

■ STUDIO A–C (Cinema Studio A–C) DCS

- CINEMA STUDIO A reproduces the sound characteristics of Sony Pictures Entertainment's classic editing studio.
- CINEMA STUDIO B reproduces the sound characteristics of Sony Pictures Entertainment's mixing studio which is one of the most up-to-date facilities in Hollywood.
- CINEMA STUDIO C reproduces the sound characteristics of Sony Pictures Entertainment's BGM recording studio.

continued

Selecting a sound field (continued)

■ **V.M.DIMENS.* (Virtual Multi Dimension)** **DCS**

Uses 3D sound imaging to create an array of virtual surround speakers positioned higher than the listener from a single pair of actual surround speakers. This mode creates 4 sets of virtual speakers surrounding the listener at approximately a 30° angle of elevation.

■ **V.SEMI M.D.* (Virtual Semi Multi Dimension)** **DCS**

Uses 3D sound imaging to create virtual surround speakers from the sound of the front speakers without using actual surround speakers. This mode creates 5 sets of virtual speakers surrounding the listener at a 30° angle of elevation.

■ **HALL**

Reproduces the acoustics of a rectangular concert hall.

■ **JAZZ (Jazz Club)**

Reproduces the acoustics of a jazz club.

■ **L.HOUSE (Live House)**

Reproduces the acoustics of a 300-seat live house.

■ **GAME**

Obtains maximum audio impact from video game software.

* “VIRTUAL” sound field: Sound field with virtual speakers.

Notes

- The effects provided by the virtual speakers may cause increased noise in the playback signal.
- When listening with sound fields that employ the virtual speakers, you will not be able to hear any sound coming directly from the surround speakers.

Use the buttons on the remote to operate the following modes.

A.F.D. (AUTO FORMAT DECODING)

Automatically detects the type of audio signal being input (Dolby Digital, DTS, or standard 2 channel stereo) and performs the proper decoding if necessary. This mode presents the sound as it was recorded/encoded, without adding any effects (ex. reverberation).

2CH ST. (2 CHANNEL)

Outputs the sound from the front left and right speakers only. Standard 2 channel (stereo) sources completely bypass the sound field processing. Multi channel surround formats are downmixed to 2 channel.

Notes

- No sound is output from the sub woofer when you select NORM. SP. (page 6) and “2CH ST.” is selected. To listen to 2 channel (stereo) sources using the front left and right speakers and a sub woofer, select “A.F.D.”.
- When you select MICRO SP., internal sound processor will automatically redirect bass sound to subwoofer.

Understanding the multi channel surround displays

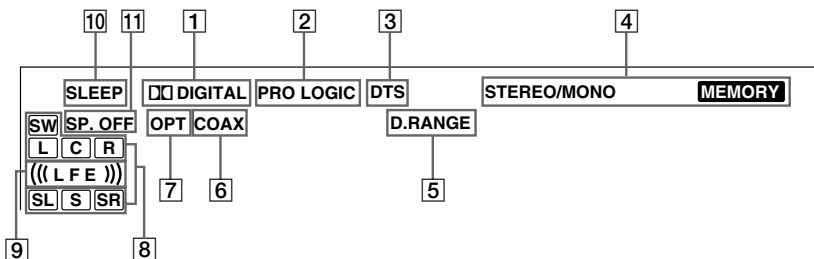

- 1 DIGITAL:** Lights up when the receiver is decoding signals recorded in the Dolby Digital format.
- 2 PRO LOGIC:** Lights up when the receiver applies Pro Logic processing to 2 channel signals in order to output the center and surround channel signals. However, this indicator does not light if the center and surround speakers are set to “NO”, and “A.F.D.” or “NORMAL SURROUND” is selected.
- 3 DTS:** Lights up when DTS signals are input.
- 4 Tuner indicators:** Light up when using the receiver to tune in radio stations, etc. See pages 24–25 for tuner operations.
- 5 D.RANGE:** Lights up when dynamic range compression is activated. See page 23 to adjust the dynamic range compression.
- 6 COAX:** Lights up when the source signal is a digital signal being input through the COAXIAL terminal.
- 7 OPT:** Lights up when the source signal is a digital signal being input through the OPTICAL terminal.
- 8 Playback channel indicators:** The letters light up to indicate the channels being played back.
L (Front Left), R (Front Right), C (Center (monaural)), SL (Surround Left), SR (Surround Right), S (Surround (monaural or the surround components obtained by Pro Logic processing)), SW (Sub woofer)
The boxes around the letters light up to indicate the speakers used to playback the channels.
- 9 ((L F E)):** Lights up when the disc being played back contains the LFE (Low Frequency Effect) channel and when the sound of the LFE channel signal is actually being reproduced.
- 10 SLEEP:** Lights up when sleep timer is activated.
- 11 SP.OFF:** Lights up when headphones are inserted.

Customizing sound fields

By adjusting the surround and level parameters of the front, center, and surround speakers, you can customize the sound fields to suit your particular listening situation.

Once you customize a sound field, the changes are stored in the memory indefinitely (unless the receiver is unplugged for about two weeks). You can change a customized sound field any time by making new adjustments to the parameters.

See the tables on page 32 for the parameters available in each sound field.

To get the most from multi channel surround sound

Position your speakers and do the procedures described in “Multi channel surround setup” starting from page 13 before you customize a sound field.

Adjusting the level parameters

The LEVEL menu contains parameters that let you adjust the balance and volumes of each speaker. The settings are applied to all sound fields.

1 Start playing a program source encoded with multi channel surround sound.

2 Press LEVEL/SURR.

The button lights up and the first parameter is displayed.

3 Press the cursor buttons (▲ or ▼) to select the parameter you want to adjust.

4 Press + or – to select the setting you want.

The setting is stored automatically.

Initial settings

Parameter	Initial setting
FRONT BALANCE*	BALANCE
SURR BALANCE*	BALANCE
CENTER LEVEL*	CTR 0 dB
SURR LEVEL*	SURR 0 dB
SUB WOOFER LEVEL*	S.W. 0 dB
LFE MIX LEVEL	L.F.E. 0 dB
DYNAMIC RANGE COMP	COMP. OFF

* These parameters can be adjusted separately for MULTI CH IN.

Front balance (▲▼)

Lets you adjust the balance between front left and right speakers.

Surround balance (▲▼)

Lets you adjust the balance between surround left and right speakers.

Center level (▲▼)

Lets you adjust the level of the center speaker.

Surround level (▲▼)

Lets you adjust the level of the surround left and right speakers.

Sub woofer level (▲▼)

Lets you adjust the level of the sub woofer.

Low Frequency Effect (▲▼)

Lets you attenuate the level of the LFE (Low Frequency Effect) channel output from the sub woofer without effecting the level of the bass frequencies sent to the sub woofer from the front, center or surround channels via the Dolby Digital or DTS bass redirection circuitry.

- “0 dB” outputs the full LFE signal at the mix level determined by the recording engineer.
- To mute the sound of the LFE channel from the sub woofer, select “OFF”. However, the low frequency sounds of the front, center, or surround speakers are output from the sub woofer according to the settings made for each speaker in the speaker setup (page 14–15).

Dynamic range compressor (D. RANGE)

Lets you compress the dynamic range of the sound track. This may be useful when you want to watch movies at low volumes late at night. We recommend using the “MAX” setting.

- To reproduce the sound track with no compression, select “COMP. OFF”.
- To reproduce the sound track with the dynamic range intended by the recording engineer, select “COMP. STD”.
- To compress the dynamic range in small steps to achieve the sound you desire, select “COMP. 0.1”–“COMP. 0.9”.
- To reproduce a dramatic compression of the dynamic range, select “COMP. MAX”.

Note

Dynamic range compression is possible with Dolby Digital sources only.

Adjusting the surround parameters

The SURR menu contains parameters that let you customize various aspects of the current sound field. The settings are stored individually for each sound field.

- 1 Start playing a program source encoded with multi channel surround sound.**
- 2 Press LEVEL/SURR.**
The button lights up and the first parameter is displayed.
- 3 Press the cursor buttons (▲ or ▼) to select the parameter you want to adjust.**
- 4 Press + or – to select the setting you want.**
The setting is stored automatically.

Initial settings

Parameter	Initial setting
EFFECT LEVEL	(depends on the sound field)
WALL TYPE	WALL MID
REVERBERATION TIME	REVB. MID

Effect level (EFFECT)

Lets you adjust the “presence” of the current surround effect.

Wall type (WALL)

Lets you control the level of the high frequencies to alter the sonic character of your listening environment by simulating a softer (S) or harder (H) wall. The midpoint designates a neutral wall (made of wood).

Reverberation (REVERB)

Lets you control the spacing of the early reflections to simulate a sonically longer (L) or shorter (S) room. The midpoint designates a standard room with no adjustment.

Resetting customized sound fields to the factory settings

- 1 If the power is on, press I/⏻ to turn off the power.**
- 2 Hold down SOUND FIELD + and press I/⏻.**
“S.F. CLR.” appears in the display and all sound fields are reset at once.

Before receiving broadcasts, make sure you have connected FM and AM antennas to the receiver (see page 6).

Manual memory

You can enter a frequency of the station you want directly by using the cursor buttons, and preset the stations to the receiver.

1 Press TUNER FM/AM to select the FM or AM band.

2 Press MEMORY/ENTER.

The receiver enters the Manual Memory mode.

The current frequency appears and the preset number flashes in the display.

Do steps 3 to 5 before “PUSH” and “ENTER” flashes in the display.

3 Press +/- to tune in a station.

If “PUSH” and “ENTER” flashes before you tune in a station, start again from step 2.

4 Press the cursor buttons (^ or v) to select a preset number.

If “PUSH” and “ENTER” flashes before you select the preset number, start again from step 2.

5 Press MEMORY/ENTER.

6 Repeat steps 2 to 5 to preset another station.

Tip

When the FM station is tuned in, you can press TUNER to switch the MONO mode to STEREO mode manually.

Automatic memory

If you don't know the frequency of the station you want, you can let the receiver scan all available stations in your area and preset the stations to the receiver.

Press and hold MEMORY/ENTER, then press I/⏻.

“AUTO MEMORY START” appears in the display.

The receiver scans from low to high frequencies of FM stations, then repeat scanning of AM stations.

When a station is tuned in, the station is automatically stored in the memory in the following order.

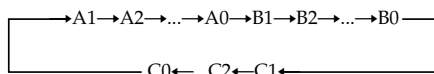

If all preset channels are memorized before scanning all stations, scanning stops and “MEM. FULL” appears in the display.

To cancel

Press I/⏻ during any step.

Tuning to preset stations

After presetting radio stations, you can tune in any of them directly by entering its 2-character preset code using the supplied remote. Up to 30 FM or AM stations can be preset. The receiver will also scan all the stations that you have preset.

You can tune the preset stations by either of the following two ways.

Scanning the preset stations

1 Press TUNER.

2 Press the cursor buttons (\wedge or \vee) repeatedly to select the preset station you want.

Each time you press the button, the receiver tunes in one preset station at a time, in the corresponding order and direction as follows:

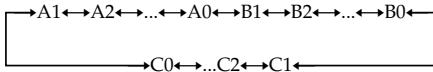

Using the preset codes

Use the supplied remote to perform the following operations. For details on the buttons used in this section, see pages 33–34.

1 Press TUNER.

The last received station is tuned in.

2 Press SHIFT to select a memory page (A, B, or C), then press the preset number of the station you want using the numeric buttons.

Automatic tuning

If you don't know the frequency of the station you want, you can let the receiver scan all available stations in your area.

1 Press TUNER FM/AM to select the FM or AM band.

The last received station is tuned in.

2 Press + or –.

Press + to scan from low to high; press – to scan from high to low.

The receiver stops scanning whenever a station is received.

When the receiver reaches either end of the band

Scanning is repeated in the same direction.

3 To continue scanning, press + or – again.

Tips

- If you press + or – during Automatic Tuning, Automatic Tuning stops.
- If you press + or – within a second after the Automatic Tuning stops, the frequency changes by a single step.

Direct tuning

You can enter a frequency of the station you want directly by using the numeric buttons on the supplied remote.

1 Press TUNER on the remote.

2 Press FM/AM to select the FM or AM band.

3 Press D.TUNING.

4 Press the numeric buttons to enter the frequency.

If you cannot tune in a station and the entered numbers flash

Make sure you've entered the right frequency. If not, repeat steps 3 and 4. If the entered numbers still flash, the frequency is not used in your area.

Using the Sleep Timer

You can set the receiver to turn off automatically at a specified time.

Press SLEEP on the remote while the power is on.

Each time you press the button, the display changes cyclically as follows:

2-00-00 → 1-30-00 → 1-00-00 → 0-30-00
→ OFF

The display dims after you have specified the time.

Tips

- You can freely specify the time. After pressing SLEEP, specify the time you want using the cursor buttons (Λ or V) on the receiver. The sleep timer can be set with an interval of 1 minute between 1 minute and 5 hours, and with an interval of 1 second for less than 1 minute.
- To check the remaining time before the receiver turns off, press SLEEP. The remaining time appears in the display.

Adjustments using the SET UP button

The SET UP button allows you to make the following adjustments.

1 Press SET UP.

2 Press the cursor buttons (Λ or V) to select the parameter you want to adjust.

When you select MULTI VI. or TUNER VI., M[XXX] or T[XXX] appears in the display after about 2 seconds.

3 Press + or – to select the setting you want.

The setting is stored automatically.

4 Repeat steps 2 to 3 until you have set all of the parameters that follow.

Initial settings

Parameter	Initial setting
MULTI VI.	DVD
TUNER VI.	OFF

■ MULTI CH IN visual select

Lets you specify the video input to be used with the audio signals from the MULTI CH INPUT jacks.

■ TUNER visual select

Lets you specify the video input to be used with the built-in tuner.

Precautions

On safety

Should any solid object or liquid fall into the cabinet, unplug the receiver and have it checked by qualified personnel before operating it any further.

On power sources

- Before operating the unit, check that the operating voltage is identical with your local power supply. The operating voltage is indicated on the nameplate at the rear of the receiver.
- The unit is not disconnected from the AC power source (mains) as long as it is connected to the wall outlet, even if the receiver itself has been turned off.
- If you are not going to use the receiver for a long time, be sure to disconnect the receiver from the wall outlet. To disconnect the AC power cord, grasp the plug itself; never pull the cord.
- AC power cord must be changed only at the qualified service shop.

On heat buildup

Although the unit heats up during operation, this is not a malfunction. If you continuously use this unit at a large volume, the cabinet temperature of the top, side and bottom rises considerably. To avoid burning yourself, do not touch the cabinet.

On placement

- Place the receiver in a location with adequate ventilation to prevent heat buildup and prolong the life of the receiver.
- Do not place the receiver near heat sources, or in a place subject to direct sunlight, excessive dust or mechanical shock.
- Do not place anything on top of the cabinet that might block the ventilation holes and cause malfunctions.

On operation

Before connecting other components, be sure to turn off and unplug the receiver.

On cleaning

Clean the cabinet, panel and controls with a soft cloth slightly moistened with a mild detergent solution. Do not use any type of abrasive pad, scouring powder or solvent such as alcohol or benzine.

If you have any question or problem concerning your receiver, please consult your nearest Sony dealer.

Troubleshooting

If you experience any of the following difficulties while using the receiver, use this troubleshooting guide to help you remedy the problem. Also, see “Checking the connections” on page 18 to verify that the connections are correct. Should any problem persist, consult your nearest Sony dealer.

There is no sound no matter which component is selected.

- Check that both the receiver and all components are turned on.
- Check that the MASTER VOLUME control is not set at “MIN”.
- Check that all speaker cords are connected correctly.
- Press MUTING to cancel the muting function.
- Check that the headphones are not connected to the PHONES jack. No sound will come from the speakers if the headphones are connected.
- Check that the receiver is not in “Demonstration Mode” (see page 2).

There is no sound from a specific component.

- Check that the component is connected correctly to the audio input jacks for that component.
- Check that the cord(s) used for the connection is (are) fully inserted into the jacks on both the receiver and the component.

continued

Troubleshooting (continued)

There is no sound from one of the front speakers.

- Connect a pair of headphones to the PHONES jack to verify that sound is output from the headphones (see page 18).

If only one channel is output from the headphones, the component may not be connected to the receiver correctly. Check that all the cords are fully inserted into the jacks on both the receiver and the component.

If both channels are output from the headphones, the front speaker may not be connected to the receiver correctly. Check the connection of the front speaker which is not outputting any sound.

There is no sound or only a very low-level sound is heard.

- Check that the speakers and components are connected securely.
- Check that you have selected the correct component on the receiver.
- Check that the headphones are not connected.
- Press MUTING if muting function is activated.
- The Thermal Protection has been activated because the receiver is overheated (“OVERHEAT” flashes in the display). Turn off the receiver, leave the receiver for a while, then turn on the power again.
- The Over Current Protection has been activated because of low impedance or short circuit (“PROTECT” flashes in the display). Turn off the receiver, eliminate the short-circuit problem and turn on the power again after about 20 seconds.

The left and right sounds are unbalanced or reversed.

- Check that the speakers and components are connected correctly and securely.
- Adjust balance parameters in the LEVEL menu.

There is severe hum or noise.

- Check that the speakers and components are connected securely.
- Check that the connecting cords are away from a transformer or motor, and at least 3 meters away from a TV set or fluorescent light.
- Move your TV away from the audio components.
- The plugs and jacks are dirty. Wipe them with a cloth slightly moistened with alcohol.

There is no sound from the center speaker.

- Make sure the sound field function is on (press SOUND FIELD +/-).
- Select a sound field containing the word “CINEMA” or “VIRTUAL” (see page 19–20).
- Adjust the speaker level (see page 17).
- Make sure the center speaker size parameter is set to either “SMALL” or “LARGE” (see page 16).

There is no sound or only a very low-level sound is heard from the surround speakers.

- Make sure the sound field function is on (press SOUND FIELD +/-).
- Select a sound field containing the word “CINEMA” or “VIRTUAL” (see page 19–20).
- Adjust the speaker level (see page 17).
- Make sure the surround speaker size parameter is set to either “SMALL” or “LARGE” (see page 15).

There is no sound from the active sub woofer.

- When you select NORM. SP., make sure the sub woofer is set to “S.W. YES” (see page 15).
- Check that “2CH ST.” is not selected (see page 20).

Radio stations cannot be tuned in.

- Check that the antennas are connected securely. Adjust the antennas and connect an external antenna if necessary.
- The signal strength of the stations is too weak (when tuning in with automatic tuning). Use Manual tuning.
- No stations have been preset or the preset stations have been cleared (when tuning by scanning preset stations). Preset the stations (see page 24).

“PCM--kHz” appears on the display.

- The sampling frequency is more than 48 kHz. Change the input player setting to 48 kHz.

The surround effect cannot be obtained.

- Make sure the sound field function is on (press SOUND FIELD +/-).

There is no picture or an unclear picture appears on the TV screen or monitor.

- Select the appropriate function on the receiver.
- Set your TV to the appropriate input mode.

The remote does not function.

- Point the remote at the remote sensor  on the receiver.
- Remove any obstacles in the path between the remote and the receiver.
- Replace both batteries in the remote with new ones, if they are weak.
- Make sure you select the correct function on the remote.
- If the remote is set to operate the TV only, use the remote to select a source or component other than TV before operating the receiver or other component.

Reference sections for clearing the receiver's memory

To clear	See
All memorized settings	page 13
Customized sound fields	page 23

Specifications

AUDIO POWER SPECIFICATIONS:

POWER OUTPUT AND TOTAL HARMONIC DISTORTION

with 8 ohm loads both channels driven, from 120 Hz – 10 kHz; rates 100 watts per channel minimum RMS power, with no more than 10% total harmonic distortion from 250 milliwatts to rated output.

Amplifier section

POWER OUTPUT

Rated Power Output at Stereo mode

(8 ohms 1 kHz, THD 0.09 %)
80 W + 80 W

Reference Power Output

(THD 0.3%)
Front¹⁾: 80 W/ch
Center¹⁾: 80 W
Surround¹⁾: 80 W/ch

1) Depending on the sound field settings and the source, there may be no sound output.

Frequency response

MICRO SP.: 150 Hz – 20 kHz
0/-3 dB
150 Hz (6 dB/oct)
Low cut Filter ON

NORMAL SP.: 20 Hz – 20 kHz
+/-0.5 dB

Inputs (Analog)

Sensitivity: 250 mV
Impedance: 50 kilohms
S/N²⁾: 95 dB
(A, 20 kHz LPF,
250 mV³⁾)

2) INPUT SHORT.

3) Weighted network, input level.

Inputs (Digital)

DVD (Coaxial) Sensitivity: –
Impedance: 75 ohms
S/N: 95 dB
(A, 20 kHz LPF)

TV, AUX (Optical)

Sensitivity: –
Impedance: –
S/N: 95 dB
(A, 20 kHz LPF)

Outputs

FRONT L/R, CENTER, SURROUND L/R,
SUB WOOFER
Voltage: 2 V
Impedance: 1 kilohms

Video section

Inputs

S-video: Y: 1 V_{p-p}, 75 ohms
C: 0.286 V_{p-p}, 75 ohms

Outputs

S-video: Y: 1 V_{p-p}, 75 ohms
C: 0.286 V_{p-p}, 75 ohms

FM tuner section

Tuning range 87.5 – 108.0 MHz

Antenna terminals 75 ohms, unbalanced

Intermediate frequency

10.7 MHz

Sensitivity

Mono: 18.3 dBf,
2.2 μV/75 ohms
Stereo: 38.3 dBf,
22.5 μV/75 ohms

Usable sensitivity

11.2 dBf, 1 μV/75 ohms

S/N

Mono: 76 dB
Stereo: 70 dB

Harmonic distortion at 1 kHz

Mono: 0.3%
Stereo: 0.5%

Separation

45 dB at 1 kHz

Frequency response

30 Hz – 15 kHz
+0.5/-2 dB

Selectivity

60 dB at 400 kHz

continued

Specifications (continued)

AM tuner section

Tuning range	With 10-kHz tuning scale: 530 – 1710 kHz ⁴⁾ With 9-kHz tuning scale: 531 – 1710 kHz ⁴⁾
Antenna	Loop antenna
Intermediate frequency	450 kHz
Usable sensitivity	50 dB/m (at 1,000 kHz or 999 kHz)
S/N	54 dB (at 50mV/m)
Harmonic distortion	0.5% (50mV/m, 400 Hz)
Selectivity	At 9 kHz: 35 dB At 10 kHz: 40 dB

4) You can change the AM tuning scale to 9 kHz ↔ 10 kHz. After tuning in any AM station, turn off the receiver. Hold down the + button and press the I/⏻ button. All preset stations will be erased when you change the tuning scale. To reset the scale to 10 kHz (or 9 kHz), repeat the procedure.

General

Power requirements	120 V AC, 60 Hz
Power consumption	98 W
Dimensions (w/h/d)	430 × 83 × 289 mm including projecting parts and controls
Mass (Approx.)	3.1 kg

Supplied accessories

Remote commander RM-U305S (1)
R6 (size-AA) batteries (2)
Coaxial digital cord (1)

Design and specifications are subject to change without notice.

Tables of settings using LEVEL/SURR and SET UP buttons

You can make various settings using the LEVEL/SURR, SET UP buttons, cursor buttons, and +/- buttons. The tables below show each of the settings that these buttons can make.

Press	Press \wedge or \vee to select	Turn jog dial to select	Page
LEVEL/SURR	FRONT BALANCE	-8 to +8 (1 increment steps)	22
	SURR BALANCE	-8 to +8 (1 increment steps)	
	CENTER LEVEL	-10 dB to +6 dB (1 dB steps)	
	SURR LEVEL	-10 dB to +6 dB (1 dB steps)	
	SUB WOOFER LEVEL	-10 dB to +6 dB (1 dB steps)	
	LFE MIX LEVEL	OFF, -20 dB to 0 dB (1 dB steps)	
	DYNAMIC RANGE COMP	OFF, 0.1 to 0.9 (0.1 steps), STD, MAX	
	EFFECT LEVEL	depends on the sound field (16 steps)	23
	WALL TYPE	S (-8 to +8), MID, H (-8 to +8) (1 increment steps)	
	REVERBERATION TYPE	S (-8 to +8), MID, L (-8 to +8) (1 increment steps)	
SET UP	  (FRONT)	LARGE, SMALL	14
	 (CENTER)	LARGE, SMALL, NO	
	  (SURR)	LARGE, SMALL, NO	
	 (SUB WOOFER)	S.W. YES, S.W. NO	
	  (FRONT) XX.X m	3 feet to 40 feet (1 foot steps)	
	 (CENTER) XX.X m	3 feet to 40 feet (1 foot steps)	
	  (SURR) XX.X m	3 feet to 40 feet (1 foot steps)	
	  (SURR) PL. XXX	PL. SIDE, PL. BEHD.	
	  (SURR) HGT. XXX	HGT. LOW, HGT. HIGH	
	MULTI VI.	TV, DVD, VIDEO, AUX, OFF	26
TUNER VI.	TV, DVD, VIDEO, AUX, OFF		

Adjustable parameters for each sound field

The adjusted LEVEL parameters are applied to all the sound fields. The adjusted SURR parameters are stored in each sound field.

	LEVEL						
	FRONT BAL.	SURR BAL.	CENTER LEVEL	SURR LEVEL	SUB WOOFER LEVEL	LFE MIX	D.RANGE COMP.
2CH	●					●	●
A.F.D.	●	●	●	●	●	●	●
NORM.SURR.	●	●	●	●	●	●	●
STUDIO A	●	●	●	●	●	●	●
STUDIO B	●	●	●	●	●	●	●
STUDIO C	●	●	●	●	●	●	●
V.M.DIMENS.	●	●	●	●	●	●	●
V.SEMI M.D.	●		●		●	●	●
HALL	●	●	●	●	●	●	●
JAZZ	●	●	●	●	●	●	●
L.HOUSE	●	●	●	●	●	●	●
GAME	●	●	●	●	●	●	●
MULTI CH IN	●	●	●	●	●		

	SURR		
	EFFECT LEVEL	WALL TYPE	REVERB TIME
2CH			
A.F.D.			
NORM.SURR.			
STUDIO A	●		
STUDIO B	●		
STUDIO C	●		
V.M.DIMENS.	●		
V.SEMI M.D.	●		
HALL	●	●	●
JAZZ	●	●	●
L.HOUSE	●	●	●
GAME	●	●	●
MULTI CH IN			

Before you use your remote

Inserting batteries into the remote

Insert R6 (size-AA) batteries with the + and – properly oriented in the battery compartment. When using the remote, point it at the remote sensor  on the receiver.

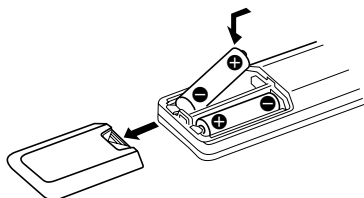

Tip

Under normal conditions, the batteries should last for about 6 months. When the remote no longer operates the receiver, replace all batteries with new ones.

Notes

- Do not leave the remote in an extremely hot or humid place.
- Do not use a new battery with an old one.
- Do not expose the remote sensor to direct sunlight or lighting apparatuses. Doing so may cause a malfunction.
- If you don't use the remote for an extended period of time, remove the batteries to avoid possible damage from battery leakage and corrosion.

Remote button description

You can use the remote to operate the components in your system. The tables below show the settings of each button.

Remote Button	Operations	Function
SLEEP	Receiver	Activates the sleep function and the duration which the receiver turns off automatically.
AV I/⏻	TV/VCR/ CD player/ DVD player/ MD deck/ VCD player/ LD player/ DAT deck	Turns the audio and video components on or off.
I/⏻	Receiver	Turns the receiver on or off.
VIDEO	Receiver	To watch VCR.
DVD	Receiver	To watch DVD.
TV	Receiver	To watch TV programs or satellite receiver.
AUX	Receiver	To listen to an audio equipment.
TUNER	Receiver	To listen to radio programs.
MULTI CH	Receiver	To listen to the sound from MULTI CH INPUT jacks.
0-9	Receiver	Use with "SHIFT" button to select tuner preset station numeric input during DIRECT TUNING or MEMORY mode.
	CD player/ MD deck/ VCD player/ LD player/ DAT deck	Selects track numbers. 0 selects track 10.
	TV/VCR/SAT	Selects channel numbers.
>10	CD player/ MD deck/ Tape deck/ LD player/ VCD player	Selects tracks numbers over 10.

continued

Remote button description (continued)

Remote Button	Operations	Function
ENTER	TV/VCR/SAT/ Tape deck/ LD player/ VCD player/ MD deck/ DAT deck	After selecting a channel, disc or track using the numeric buttons, press to enter the value.
SHIFT	Receiver	Press repeatedly to select a memory page for presetting radio stations or tuning to preset stations.
-/--	TV	Selects the channel entry mode, either one or two digit.
D.TUNING	Receiver	Tuner station direct key-in mode.
⏮/⏭	CD player/ MD deck/ DVD player/ LD player/ VCD player/ Tape deck/VCR/ DAT deck	Skips tracks.
⏪/⏩	CD player/ DVD player/ VCD player/ MD deck/ LD player Tape deck/ VCR/ DAT deck	Searches tracks (forward or backward). Fastforwards or rewinds, rewinds. Searches tracks when pressed during playback.
◀	Tape deck	Starts play on the reverse side.
▶	CD player/ MD deck/Tape deck/VCR/ DVD player/ VCD player/ LD player/ DAT deck	Starts play.

Remote Button	Operations	Function
⏸	CD player/ MD deck/Tape deck/VCR/ DVD player/ VCD player/ LD player/ DAT deck	Pauses play or record. (Also starts recording with components in record standby.)
■	CD player/ MD deck/Tape deck/VCR/ DVD player/ VCD player/ LD player/ DAT deck	Stops play.
POSITION*	TV	Changes the position of the small picture.
SWAP*	TV	Swaps the small and the large picture.
DISC	CD player	Select discs (Mega storage CD player only).
SUB CH +/-*	TV	Selects preset channels for the small picture.
D. SKIP/CH/ PRESET +/-	Receiver TV/VCR/SAT	Scans and selects preset stations. Selects preset channels.
	CD player/ MD deck/ DVD player/ VCD player	Skips discs (multi-disc changer only).
DISPLAY	TV/VCR/ LD player/ DVD player/ VCD player	Selects information displayed on the TV screen.
P IN P*	TV	Activates the picture-in-picture function.
JUMP	TV	Toggles between the previous and the current channels.
WIDE	TV	Selects the wide picture mode.

Remote Button	Operations	Function
ANT TV/VTR	VCR	Selects output signal from the aerial terminal: TV signal or VCR program.
TV/VIDEO	TV	Selects the input of TV.
FM/AM	Receiver	Select the band.
A.F.D.	Receiver	Auto Format Decoding.
2CH/OFF	Receiver	Turns off sound field or selects 2CH mode.
MODE +/-	Receiver	Selects sound field mode.
MUTING	Receiver	Mutes the sound from the receiver.
TEST TONE	Receiver	Press to output test tone.
MAIN MENU	Receiver	Selects the set up mode of the receiver.
MASTER VOL +/-	Receiver	Adjusts the master volume of the receiver.
MENU </>	Receiver	Selects a menu item.
MENU +/-	Receiver	Makes adjustment or change the setting.
MENU	DVD player	Displays DVD menu.
⇄/⇅/⇆/⇇	DVD player	Selects a menu item.
ENTER	DVD player	Enters the selection.
RETURN	DVD player	Returns to the previous menu or exits the menu.
TITLE	DVD player	Displays DVD title.

* Only for Sony TVs with the picture-in-picture function.

Notes

- Some functions explained in this section may not work depending on the model of the receiver.
- The above explanation is intended to serve as an example only.
Therefore, depending on the component the above operation may not be possible or may operate differently than described.

Changing the factory setting of a function button

If the factory settings of the function buttons do not match your system components, you can change them. For example, if you have an MD player and a tape deck and you do not have a DVD player, you can assign the DVD button to your tape deck.

Note that the settings of the TUNER button cannot be changed.

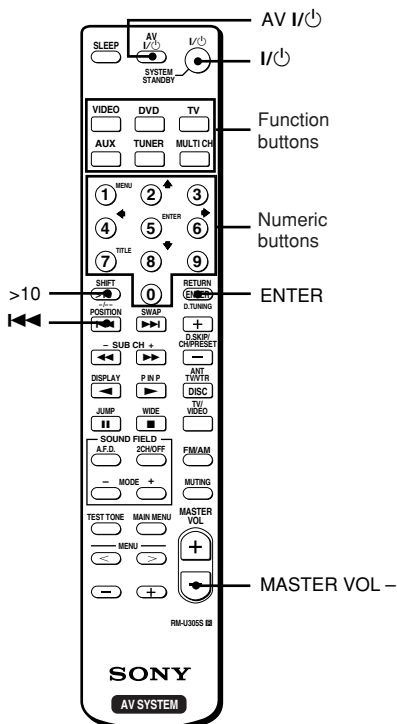

1 Hold down the Function button whose function you want to change (for example, DVD).

2 Press the corresponding button of the component you want to assign to the Function button (for example, 4 – Tape deck).

The following buttons are assigned to select the functions:

To operate	Press
CD player	1
DAT deck	2
MD deck	3
Tape deck A	4
Tape deck B	5
LD player	6
VCR (command mode VTR 1*)	7
VCR (command mode VTR 2*)	8
VCR (command mode VTR 3*)	9
TV	0
DSS (Digital Satellite Receiver)	>10
DVD player	ENTER
VCD player	◀◀

* Sony VCRs are operated with a VTR 1, 2 or 3 setting. These correspond to Beta, 8mm and VHS respectively.

Now you can use the DVD button to control the tape deck.

To reset a button to its factory setting

Repeat the above procedure.

To reset all the function buttons to their factory setting

Press I/O, AV I/O and MASTER VOL – at the same time.