

***FM Stereo
FM-AM Tuner***

Operating instructions

ST-SA50ES

WARNING

To prevent fire or shock hazard, do not expose the unit to rain or moisture.

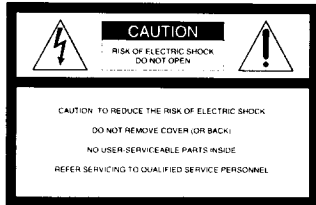

This symbol is intended to alert the user to the presence of uninsulated "dangerous voltage" within the product's enclosure that may be of sufficient magnitude to constitute a risk of electric shock to persons.



This symbol is intended to alert the user to the presence of important operating and maintenance (servicing) instructions in the literature accompanying the appliance.

Note to CATV system installer

This reminder is provided to call the CATV system installer's attention to Article 820-40 of the NEC that provides guidelines for proper grounding and, in particular, specifies that the cable ground shall be connected to the grounding system of the building, as close to the point of cable entry as practical.

CAUTION

You are cautioned that any changes or modifications not expressly approved in this manual could void your authority to operate this equipment.

INFORMATION

This equipment has been tested and found to comply with the limits for a Class B digital device, pursuant to Part 15 of the FCC Rules. These limits are designed to provide reasonable protection against harmful interference in a residential installation. This equipment generates, uses, and can radiate radio frequency energy and, if not installed and used in accordance with the instructions, may cause harmful interference to radio communications. However, there is no guarantee that interference will not occur in a particular installation. If this equipment does cause harmful interference to radio or television reception, which can be determined by turning the equipment off and on, the user is encouraged to try to correct the interference by one or more of the following measures:

- Reorient or relocate the receiving antenna.
- Increase the separation between the equipment and receiver.
- Connect the equipment into an outlet on a circuit different from that to which the receiver is connected.
- Consult the dealer or an experienced radio/TV technician for help.

Owner's Record

The model and serial numbers are located on the rear panel. Record the serial number in the space provided below. Refer to them whenever you call upon your Sony dealer regarding this product.

Model No. ST-SA50ES

Serial No. _____

Precautions

On safety

- Should any liquid or solid object fall into the unit, unplug the unit and have the unit checked by qualified personnel before operating it any further.

On power sources

- Before operating the unit, be sure that the operating voltage of your unit is identical with that of your local power supply.
- Unplug the unit from the wall outlet if it is not to be used for an extended period of time. To disconnect the cord, pull it out by grasping the plug. Never pull the cord itself.
- AC power cord must be changed only at a qualified service shop.

On placement

- Place the unit in a location with adequate ventilation to prevent heat build-up and prolong the life of its components.
- Do not place the unit near heat sources, or in a place subject to direct sunlight, excessive dust or mechanical shock.
- Do not place anything on top of the unit which might block the ventilation holes and cause malfunctions.

On cleaning the cabinet

- Clean the cabinet, panels and controls with a soft cloth lightly moistened with a mild detergent solution. Do not use any type of abrasive pad, scouring powder or solvent such as alcohol or benzine.

On repacking

- Do not throw away the carton and the packing material. This makes an ideal container when transporting the unit. When shipping the unit, repack it as it was packed at the factory.

If you have any question or problem concerning your unit that is not covered in this manual, please consult your nearest Sony dealer.

Welcome!

Thank you for purchasing the Sony FM Stereo FM/AM Tuner. Before operating the unit, please read this manual thoroughly and retain it for future reference.

About This Manual

The instructions in this manual describe the operation of the Sony ST-SA50ES tuner. Check your model number by looking at the lower right corner of the front panel.

Conventions

The following icon is used in this manual:

 Indicates hints and tips for making the task easier.

TABLE OF CONTENTS

Basic Operations

Receiving Preset Stations 4

Getting Started

Unpacking 5
Hooking up the System 5
About the Menu Entry System 7
Customizing the Display 7
Presetting the Radio Stations 8

Advanced Tuner Operations

Tips for Better FM Reception 10
Naming Preset Stations 11
Sorting Preset Stations 11

Additional Information

Troubleshooting 12
Specifications 12
Index 13

Receiving Preset Stations

This section shows you how to receive preset stations.

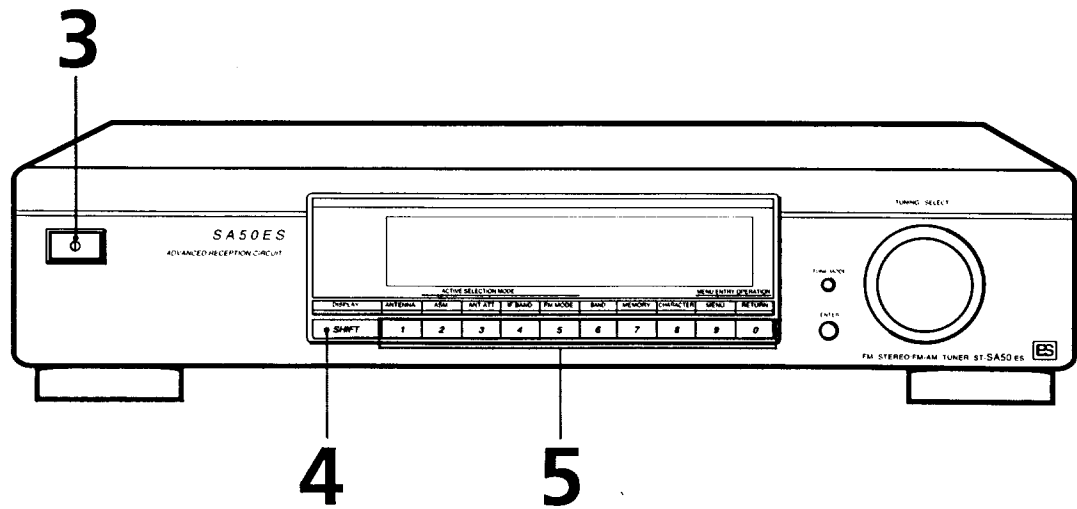

• To tune in a non-preset station, see "Tuning stations (Automatic Tuning)" on page 8.

- 1 Make sure you've hooked up the tuner and preset stations. (See pages 5 - 7 for hookups and page 8 for presetting.)
- 2 Turn on the amplifier and select the TUNER mode.
- 3 Press  to turn on the tuner.
- 4 Press SHIFT to select A, B, C, or D.
- 5 Press the preset number you want (1 - 0).

To check broadcasts by scanning the preset stations

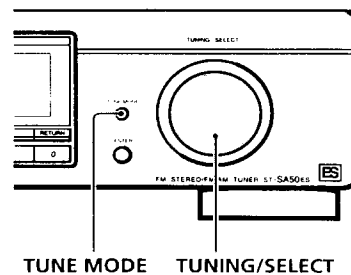

- 1 Press TUNE MODE repeatedly until "PRESET" appears in the display.
- 2 Turn TUNING/SELECT. Each time you turn TUNING/SELECT, a preset station is received and the settings (preset code, frequency, and station name, etc.) appear in the display. The signal meter indicates the strength of the broadcast signal.

Unpacking

Check that you received the following items with the tuner:

- Audio cord (1)
- AM loop antenna (1)
- FM wire antenna (1)
- Antenna adapter (75 Ω /300 Ω F type) (1)

Hooking up the System

Before you get started

- Turn off the power to all components before making any connections.
- Do not connect to the wall outlet until all of the connections are completed.
- Be sure to make connections firmly to avoid hum and noise.
- When connecting the audio cord, be sure to match the color-coded pins to the appropriate jacks: white (L) to white; and red (R) to red.

AM antenna hookups

This section describes how to connect the supplied AM loop antenna and an insulated wire (not supplied). For the specific location of the AM ANTENNA terminals, see the illustration below.

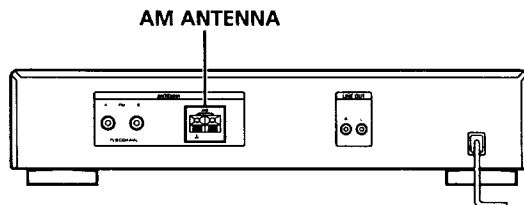

- 1 Before assembling the supplied antenna, pull the coaxial cable out from the slot in the antenna frame.
- 2 Unwrap 4 lengths of the coaxial cable from around the frame of the antenna. Be careful to unwrap only the coaxial cable. Do not unwrap more than 4 lengths of the coaxial cable.

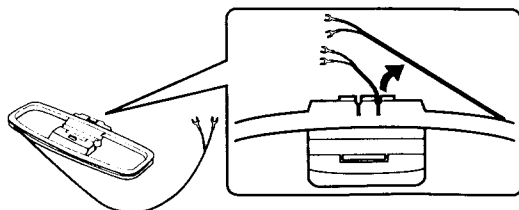

- 3 Assemble the supplied antenna as shown below.

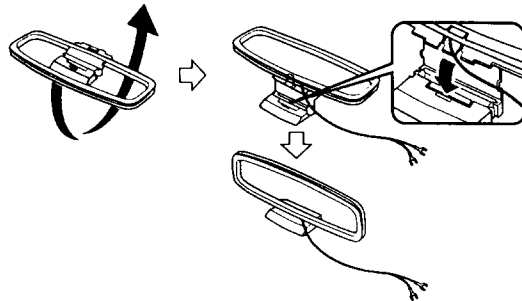

- 4 Connect the AM loop antenna to the AM terminals on the back of this unit. For best reception, connect an insulated wire (not supplied) in addition to the AM loop antenna. (See "For best AM reception" below.)

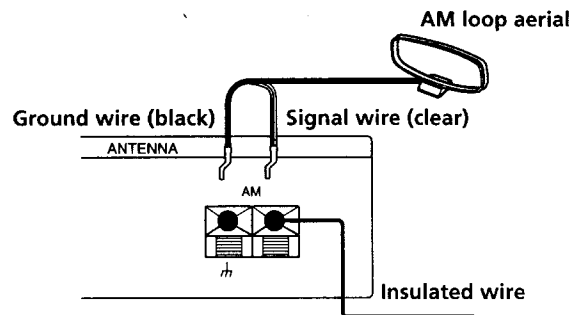

- 5 Adjust the antenna direction for the best reception. The AM loop antenna has a directivity which detects the signal from some angles more strongly than others. Set the antenna to the orientation which provides the best receiving condition.

For stations that are difficult to receive
Try repositioning the loop antenna while tuning. Placing the supplied AM loop antenna near a window will help improve reception quality.

For best AM reception
Connect a 20 to 48 foot (6 to 15 meter) insulated wire (not supplied) to the AM antenna terminal in addition to the AM loop antenna. Try to extend the wire outdoors and keep it horizontal. Do not disconnect the AM loop antenna.

(continued)

Getting Started

FM Antenna Hookups

With an FM outdoor antenna, you can obtain a higher FM broadcast sound quality. We recommend you to use the supplied FM wire antenna only temporarily until you install an FM outdoor antenna. For the specific location of the FM ANTENNA terminals, see the illustration below.

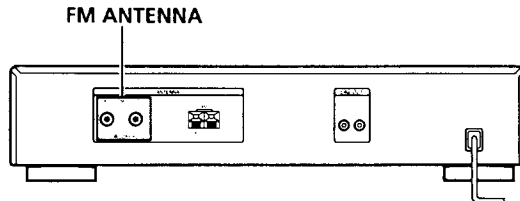

Connecting a 75-ohm coaxial cable (not supplied)

The coaxial cable makes the reception more resistant to external noise. We recommend you to use a 3C-2V type cable.

- 1 Strip the cable end.

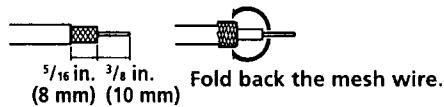

- 2 Remove the lid of the supplied antenna adaptor.

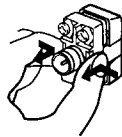

- 3 Loosen the screw, insert the conductor wire deeply, and coil the tip around the terminal.

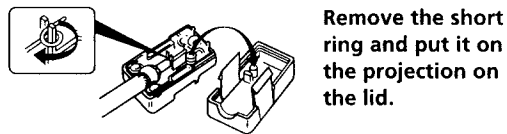

- 4 Fasten the screw and snap the lid into place.

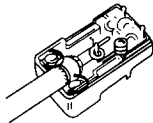

- 5 Connect to the FM antenna terminal.

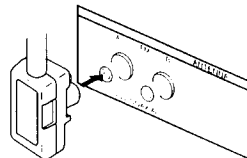

Connecting the supplied 300-ohm twin lead antenna

Since the 300-ohm twin lead picks up external noise easily, position it carefully.

- 1 Coil the ends of the antenna around the screws and tighten them securely.



- 2 Connect to the FM antenna terminal.

Extend the upper portion of the FM antenna horizontally.

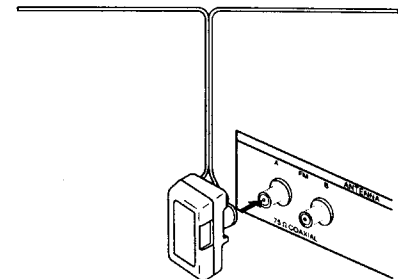

Connecting a F type connector (not supplied)

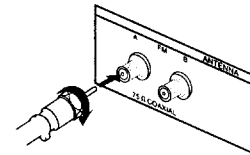

💡 You can use two FM antennas

This tuner has two FM ANTENNA terminals, A and B, for use with different types of FM antennas. For example, you can connect an outdoor antenna to the A jack and connect a cable antenna to the B jack. You can also switch the antenna while using the signal meter to determine which antenna gives the best reception for a particular station.

Connecting a ground wire

If you connect an outdoor antenna, be sure to connect a ground wire (not supplied) to the AM ANTENNA terminal (in addition to the AM loop antenna) for lightning protection.

Amplifier hookups

Connect the tuner to an amplifier. Be sure to turn off the power to both components before connection. For the specific location of the terminals, see the illustration below.

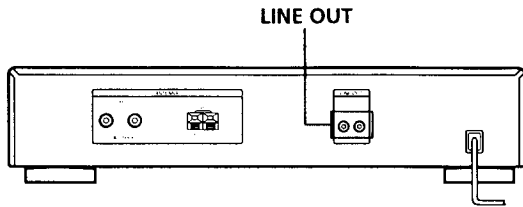

What cables will I need?

- Audio cord (supplied) (1)

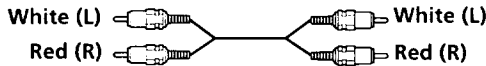

Connect the white plugs to the white (L) jacks and the red plugs to the red (R) jacks. Insert the plugs completely into the jacks; incomplete connections may cause noise.

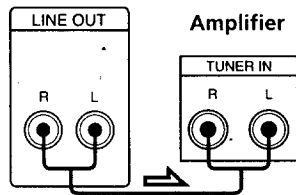

Power connection hookup

Connect the power cord to a wall outlet after completing all of the previous connections.

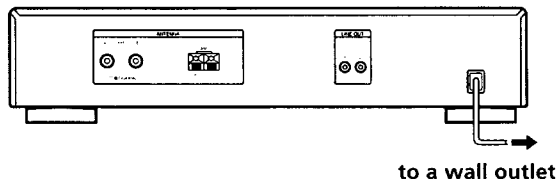

About the Menu Entry System

This tuner uses a menu entry system which allows you to operate various functions by following messages that appear in the display. Use the following controls for menu operation.

Use the	To:
MENU button	enter the menu mode.
TUNING/SELECT knob	display different items or settings.
ENTER button	select the currently displayed item or setting.
RETURN button	return to a previous stage in the menu mode.

Customizing the Display

You can choose the appearance of the display from one of the following four display modes.

- 1 Press MENU, then turn TUNING/SELECT until "Disp-Mode" appears in the display.
- 2 Press ENTER. "Select" appears in the display.
- 3 Turn TUNING/SELECT to select a display mode.

Full Display/Full Brightness



Full Display/Dimmed



Minimal Display/Full Brightness



Minimal Display/Dimmed

- 4 Press ENTER. The setting remains in effect until you change it again. If you press one of the buttons on the main unit, the minimal display changes to the full display with the selected brightness. After about 4 seconds, the display returns to the display mode you selected.

Presetting the Radio Stations

With "Auto Memory" you can automatically store up to 40 stations in alphabetical order without redundancy. Additionally, you can set "Auto Memory" to store only stations with signals that are stronger than a set level. If you want to store FM or AM stations one by one, see "Tuning stations (Automatic Tuning)" and "Storing stations."

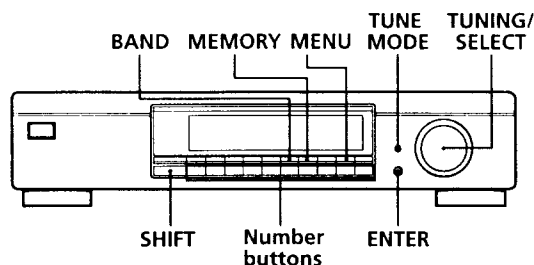

Storing stations automatically (Auto Memory)

- 1 Press MENU.
- 2 Turn TUNING/SELECT until "Auto Memory" appears in the display and press ENTER.
- 3 Turn TUNING/SELECT to set 30 dB FM/3 AM, 50 dB FM/5 AM, or 70 dB FM/7 AM as the minimum signal strength required to be added as a preset and press ENTER.

The tuner begins scanning in the low end of the FM frequencies. Stations broadcasting signals above the minimum level requirement are stored and assigned a two-character preset code. When the FM band is complete, scanning continues from the low end of the AM frequencies.

Notes

- If you move to another area, repeat this procedure to store stations in your new area.
- For details on tuning stored stations, see page 4.
- The ANTENNA, ANT ATT, IF BAND, and FM MODE settings are also stored along with the station.
- If you move the antenna after storing stations using "Auto Mode," the stored settings may no longer be valid. If this happens, store the stations again.

Tuning stations (Automatic Tuning)

With automatic tuning you can quickly tune in a station without having to know its frequency.

- 1 Press BAND to choose either FM or AM.
- 2 Press TUNE MODE so that "AUTO TUNING" appears in the display.
- 3 Turn TUNING/SELECT slightly and release it when the frequency numbers start changing. Turn the knob to the right for a higher frequency; turn it to the left for a lower frequency. When the tuner locates a station, it stops automatically, "TUNED" appears in the display, and the signal meter indicates the strength of the broadcast signal.
- 4 Repeat step 3 until you tune in the appropriate station. To store the station, see "Storing stations" on page 9.

💡 If you cannot tune in the station you want (Manual Tuning)

With manual tuning you can search through all stations broadcasting on each band, and tune in stations with extremely weak signals that you might not be able to receive with automatic tuning.

- 1 Press BAND repeatedly to choose FM or AM.
- 2 Press TUNE MODE so that only "TUNING" appears in the display. "AUTO" should not appear in the display.
- 3 Turn TUNING/SELECT until you tune in the desired station. Turn the knob to the right for a higher frequency; turn it to the left for a lower frequency. The signal meter indicates the strength of the broadcast signal.

Note

When you reach the highest or lowest frequency of any band, tuning stops.

💡 When you tune in AM stations

Adjust the direction of the AM loop antenna for optimum reception.

Storing stations

This section shows you how to store up to 40 of your favorite FM or AM stations manually onto two-character preset codes made up of a character (A, B, C, or D) and a number (1-0), such as A7. You can store up to 10 stations on each of the 4 different letters. You can use these letters to classify stations according to music category or station band.

- 1** Tune in the FM or AM station you wish to store.
- 2** Press MEMORY.
"MEMORY" appears along with the lowest vacant code to indicate that the tuner is ready to store the station.
- 3** Press SHIFT to choose either A, B, C or D.
The letter you choose appears in the display.
- 4** Press a number button (1-0).
The tuner stores the station at the preset code you specified and the corresponding indicator lights on the preset calendar.
- 5** Repeat steps 1 through 4 to store other stations.

If you want to label the stations

Follow the procedure described in "Naming Preset Stations" on page 11.

Erasing preset stations

You can erase preset stations one by one.

- 1** Press MENU.
- 2** Turn TUNING/SELECT so that "Edit" appears in the display and press ENTER.
- 3** Turn TUNING/SELECT so that "Erase" appears in the display and press ENTER.
- 4** Turn TUNING/SELECT so that the preset you want to erase appears in the display.
- 5** Press ENTER.
The station is cleared from the preset memory. The respective indicator on the preset calendar goes out.

If you want to erase all the preset stations

- 1** Turn off the power
- 2** While holding down the number 5 button and MENU, press  to turn on the power.

Tips for Better FM Reception

This tuner has various functions designed for better reception. First, try to receive stations with the standard settings. If the reception is not good, try altering the reception quality to obtain a clear signal. The tuner stores the following adjustments together with the frequency when you make a station preset.

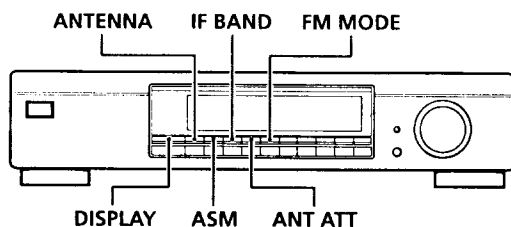

Selecting FM antennas

When you use two FM antennas, press ANTENNA to select FM ANTENNA terminal A or B. By selecting the antenna, you may be able to receive a station that cannot be received otherwise.

Changing the Active Selection Mode (ASM)

Press ASM.

The ASM indicator appears in the display. This tuner's Active Selection Mode (ASM) is factory preset to find the best antenna attenuator (ANT ATT), intermediate frequency band (IF BAND), and FM MODE settings for each frequency automatically. You can, however, choose each setting manually according to your preference. If you don't want to use the ASM function, turn it off by pressing ASM again.

To set the ANT ATT manually

Press ANT ATT.

The ANT ANN indicator lights in the display. Turn the antenna attenuator on to lower the level of the signal from FM stations with extremely high signal output levels (more than 70 dB). During normal use, however, this function should be off.

To set the IF BAND manually

Press IF BAND.

The NARROW indicator lights in the display. Changing the intermediate frequency band to "Narrow" improves selectivity and reduces interference to make broadcasts with weak signals easier to listen to. When the indicator is off, the unit tunes only the stations with high sound quality and low distortion.

To set the FM mode manually

Press FM MODE a few times to choose the reception mode. Select either Auto stereo (no indication), HI-BLEND, or MONO.

- Auto stereo mode receives stereo broadcasts with strong signals. Press FM MODE until both "HI-BLEND" and "MONO" disappear.
- "HI-BLEND" reduces noise in the high frequencies. You can receive stereo broadcasts with less noise, but the stereo sound quality will be slightly diminished.
- "MONO" receives stations with weak signals. Stations will be received in monaural but with even less noise.

Checking the signal strength

You can use the digital signal meter to check the signal strength of FM frequencies. The display range of the digital meter is from 16 to 70 dB (1 μ V of radio frequency voltage = 0 dB). To obtain a signal to noise ratio sufficient for receiving a stereo broadcast, we recommend a reading greater than 50 dB. (You can also change the FM MODE while using the signal meter to determine the best reception.)

- 1 Tune in an FM station.
- 2 Press DISPLAY repeatedly to display the digital signal meter
- 3 Rotate the FM antenna to obtain the strongest signal.

Naming Preset Stations

You can assign a name up to 8 characters long to each preset station. When the station is tuned in, the station name will appear along with the frequency.

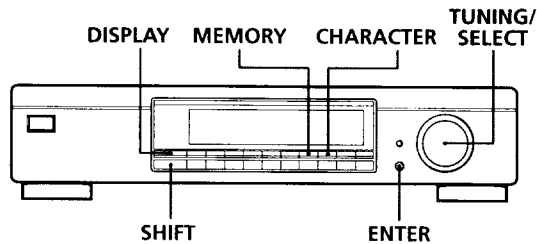

- 1 Press CHARACTER.
The cursor blinks in the display.
- 2 Turn TUNING/SELECT to select a character.
See the list below for the characters available.
- 3 When the character you want appears, press CHARACTER to move the cursor into position for the next character.

If you make a mistake

Press CHARACTER repeatedly until the character you want to change flashes (every time you press CHARACTER, the next character flashes). Then turn TUNING/SELECT to select a new character.

- 4 Repeat steps 2 and 3 until the station name you desire appears in the display.
- 5 Press MEMORY.
- 6 Press SHIFT and one of the preset buttons to specify the preset where you want to store the station name.

Character list

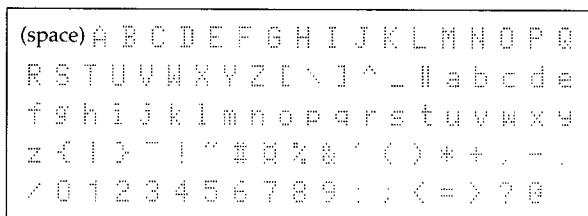

Note

The display returns to normal display mode if you stop assigning names for more than 8 seconds. If this happens, start again from the beginning.

To see the frequency of the displayed station name
Press DISPLAY repeatedly.

Sorting Preset Stations

This tuner's sorting feature lets you arrange your station presets automatically according to alphabetical order, signal strength, or tuner band.

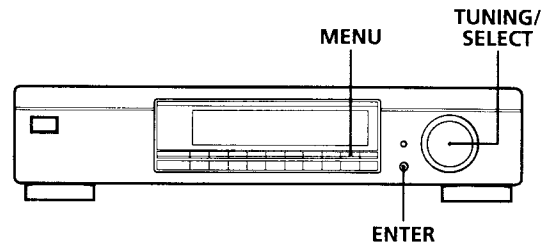

- 1 Press MENU.
- 2 Turn TUNING/SELECT until "Edit" appears in the display and press ENTER.
If no stations have been stored as presets, "No Preset" appears in the display.
- 3 Turn TUNING/SELECT to choose one of the following sorting methods:

Choose	To sort
Alphabet	preset stations in alphabetical order according to their preset names. Stations without preset names are arranged by frequency, from low to high.
Strength	preset stations in order of their signal strength (FM stations only). AM frequencies are arranged by frequency.
Band	stations in order of their frequency band (FM - AM).

- 4 Press ENTER.
The tuner sorts the stations, then returns to normal tuning mode and receives preset station A1.

Troubleshooting

If you experience any of the following difficulties while using the tuner, use this troubleshooting guide to help you remedy the problem. Should any problem persist, consult your nearest Sony dealer.

There's no sound.

- ➔ Connect the antennas.
- ➔ Set the source setting on the amplifier to TUNER.

You cannot tune in a frequency.

- ➔ Adjust the position of the antenna.
- ➔ Connect an external antenna (for FM broadcasts) or run an extra length of wire from the AM ANTENNA connector (for AM broadcasts).
- ➔ Set IF BAND to "Narrow".
- ➔ Preset the stations again if you've moved.

There is severe hum and/or background noise.

- ➔ Adjust the position or direction of the antenna.
- ➔ Tune to the correct frequency.
- ➔ Connect an external antenna (for FM broadcasts) or run an extra length of wire from the AM ANTENNA connector (for AM broadcasts).
- ➔ Move the tuner away from the source of the noise.

"No preset" appears in the display.

- ➔ If the power cord is disconnected from the wall outlet for more than one month, the memory is erased. Preset stations again.

The station name does not appear in the display.

- ➔ Press DISPLAY until the station name appears.

The appropriate display or information does not appear.

- ➔ Turn the power off. Press and hold MENU and the 5 button and press POWER to turn the power back on. This empties any frequencies stored in the preset memory.

Specifications

FM tuner section

Frequency range	87.5 - 108.0 MHz
Antenna terminals	75 ohms, unbalanced
Intermediate frequency	10.7 MHz
Sensitivity	at 26 dB quieting (mono) 10.3 dBf, 0.9 μ V/75 Ω at 46 dB quieting (stereo) 38.5 dBf, 23 μ V/75 Ω
Usable sensitivity (IHF)	10.3 dBf, 0.9 μ V/75 Ω
S/N	at 40 kHz deviation 95 dB (mono), 86 dB (stereo)
Harmonic distortion	WIDE 0.008% (mono), 0.02% (stereo) NARROW 0.04% (mono), 0.07% (stereo)
Frequency response	15 Hz - 15 kHz (\pm 0.2 dB)
Separation	65 dB at 1 kHz
Selectivity	at 400 kHz WIDE 80 dB NARROW 90 dB at 300 kHz WIDE 45 dB NARROW 70 dB
Output	at 40 kHz deviation 600 mV

AM tuner section

Frequency range	AM: 530 - 1,710 kHz (10 kHz step)
Intermediate frequency	450 kHz
Usable sensitivity	(with AM loop antenna) 200 μ V/m
Signal-to-noise ratio	AM: 54 dB (50 mV/m, 1050 kHz)
Harmonic distortion	0.3% (50 mV/m, 400 Hz)
Selectivity	50 dB
General	
Power requirements	120 V, AC 60 Hz
Power consumption	13 W
Dimensions	16 ¹⁵ / ₁₆ x 3 ⁷ / ₈ x 14 ³ / ₁₆ in. (430 x 98 x 360 mm)
Weight	9 lbs. 1 oz. (4.1 kg)
Supplied accessories	Audio cord (1) AM loop antenna (1) FM wire antenna (1) Antenna adapter (1)

Design and specifications are subject to change without notice.

Index

A, B

- Amplifier hookups 7
- ANT ATT 10
- Antenna hookups
 - AM 5
 - FM 6
- ASM 10
- Automatic tuning 8
- Auto Memory 8

C

- Connecting. *See* Hookups

D, E

- Digital signal meter 10
- DISPLAY 10
- Display mode 7
- Erasing presets 9

F, G

- FM mode 10

H

- Hookups
 - AM antenna 5
 - amplifier 7
 - FM antenna 6
 - power cord 7

I, J, K, L

- IF band 10

M

- Manual tuning 8
- Memory 8, 9, 11

N, O

- Naming stations 11
- Narrow 10

P, Q

- Presetting
 - AM stations 8
 - FM stations 8
- Preset tuning
 - AM stations 4
 - FM stations 4

R

- Receiving preset stations 4

S

- Signal meter 10
- Sorting stations 11
- Storing radio stations 8, 9

T

- Troubleshooting 12
- TUNE MODE 4
- Tuning. *See* Receiving preset stations

U, V, W, X, Y, Z

- Unpacking 5