













—

Notebook Computer

**VGN-A130 & VGN-A170**  
**Quick Start**

**SONY®**

## Shortcut Menu

 +F1	Displays the VAIO Help and Support Center window.
 +Tab	Switches the selected button on the taskbar.
 +D	Displays the desktop.
 +E	Displays the My Computer window.
 +F	Displays the Search Results window, where you can find a file or folder. This is the equivalent of selecting Search from the Start menu.
 +Ctrl+F	Displays the Search Results - Computers window, where you can locate other computers. This is the equivalent of selecting Search, and then Computer from the Start menu.
 +M	Minimizes all displayed windows.
Shift+  +M	Returns all minimized windows to their previous size.
 +R	Displays the Run window. This is the equivalent of selecting Run from the Start menu.
Fn+  +Insert	Displays the System Properties window. This is the equivalent of selecting Control Panel, and then System from the Start menu.
Fn+F5	Decreases the LCD screen brightness.
Fn+F6	Increases the LCD screen brightness.
Fn+F7	Toggles the display between the computer screen (LCD), a connected external display, and both the LCD and an external display.
Fn+F12	Puts the system into Hibernate mode, a power management state. To return the system to normal operating mode, press the power button.
Fn+Esc	Puts the system into Standby mode, a power management state. To return the system to the active state, press any key or the power button.

# Contents

<b>Notice to Users .....</b>	<b>5</b>
<b>Setting Up .....</b>	<b>13</b>
Unpacking Your Computer .....	13
Locating Controls and Ports .....	15
About the Indicator Lights .....	23
<b>Getting Started .....</b>	<b>25</b>
Turning On Your Computer .....	25
Using the Touch Pad .....	31
Registering Your Computer .....	32
Locating Your VAIO Computer User Guide .....	33
Setting Up A Dial-Up Connection .....	35
Turning Off Your Computer .....	36
<b>VAIO Recovery Wizard Utility.....</b>	<b>37</b>
<b>Troubleshooting .....</b>	<b>39</b>
Support Options.....	42



# Notice to Users

© 2004 Sony Electronics Inc. All rights reserved. This manual and the software described herein, in whole or in part, may not be reproduced, translated, or reduced to any machine-readable form without prior written approval.

SONY ELECTRONICS INC. PROVIDES NO WARRANTY WITH REGARD TO THIS MANUAL, THE SOFTWARE, OR OTHER INFORMATION CONTAINED HEREIN AND HEREBY EXPRESSLY DISCLAIMS ANY IMPLIED WARRANTIES OF MERCHANTABILITY OR FITNESS FOR ANY PARTICULAR PURPOSE WITH REGARD TO THIS MANUAL, THE SOFTWARE, OR SUCH OTHER INFORMATION. IN NO EVENT SHALL SONY ELECTRONICS INC. BE LIABLE FOR ANY INCIDENTAL, CONSEQUENTIAL, OR SPECIAL DAMAGES, WHETHER BASED ON TORT, CONTRACT, OR OTHERWISE, ARISING OUT OF OR IN CONNECTION WITH THIS MANUAL, THE SOFTWARE, OR OTHER INFORMATION CONTAINED HEREIN OR THE USE THEREOF.

Sony Electronics Inc. reserves the right to make any modification to this manual or the information contained herein at any time without notice. The software described herein is governed by the terms of a separate user license agreement.

This product contains software owned by Sony and licensed by third parties. Use of such software is subject to the terms and conditions of license agreements enclosed with this product. Some of the software may not be transported or used outside the United States. Software specifications are subject to change without notice and may not necessarily be identical to current retail versions.

Updates and additions to software may require an additional charge. Subscriptions to online service providers may require a fee and credit card information. Financial services may require prior arrangements with participating financial institutions.

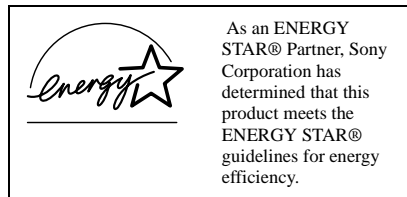

The International ENERGY STAR® Office Equipment Program is an international program that promotes energy saving through the use of computers and other office equipment. The program backs the development and dissemination of products with functions that effectively reduce energy consumption. It is an open system in which business proprietors can participate voluntarily. The targeted products are office equipment such as computers, displays, printers, facsimiles and copiers. Their standards and logos are uniform among participating nations. ENERGY STAR is a U.S. registered mark.

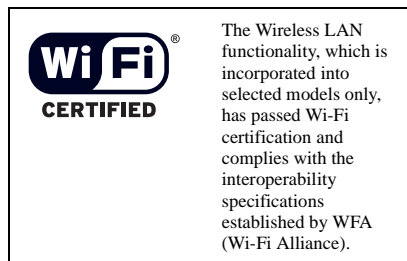

Sony, i.LINK, MagicGate™ Memory Stick, Memory Stick PRO, Memory Stick Duo, VAIO, and the VAIO logo are trademarks of Sony Corporation. Microsoft, Windows Media, Windows, Windows NT, and the Windows logo are registered trademarks of Microsoft Corporation.

This product incorporates copyright protection technology that is protected by U.S. patents and other intellectual property rights. Use of this copyright protection technology must be authorized by Macrovision, and is intended for home and other limited viewing uses only unless otherwise authorized by Macrovision. Reverse engineering or disassembly is prohibited.

i.LINK is a trademark of Sony used only to designate that a product contains an IEEE 1394 connection. The i.LINK connection may vary, depending on the software applications, operating system, and compatible i.LINK devices. All products with an i.LINK connection may not communicate with each other. Please refer to the documentation that came with your compatible i.LINK device for information on operating conditions and proper connection. Before connecting compatible i.LINK PC peripherals to your system, confirm their operating system compatibility and required operating conditions. All other trademarks are trademarks of their respective owners.

### **End User / Product Activation Requirements**

Certain software product(s) included with this computer may include features such as copy protection and content management technology. Use of the software product(s) requires agreement to applicable end user agreements and full compliance with applicable product activation procedures. Product activation procedures and privacy policies will be detailed during initial launch of the software product(s), or upon certain reinstallations of the software product(s) or reconfiguration of the computer, and may be completed by Internet or telephone (toll charges may apply).

### **Owner's Record**

The model number and serial number are located on the bottom of your Sony VAIO® computer. Record the model and serial numbers in the space provided here, and keep in a secure location. Refer to the model and serial numbers when you call your Sony Service Center.

Model Number: \_\_\_\_\_

Serial Number: \_\_\_\_\_

### **Safety Information**

#### **WARNING**

- To prevent fire or shock hazard, do not expose your computer to rain or moisture.
- To avoid electrical shock, do not open the cabinet. Refer servicing to qualified personnel only.
- Never install modem or telephone wiring during a lightning storm.
- Never install telephone jacks in wet locations unless the jack is specifically designed for wet locations.
- Never touch uninsulated telephone wire or terminals unless the telephone line has been disconnected at the network interface.
- Use caution when installing or modifying telephone lines.
- Avoid using the modem during an electrical storm.
- Do not use the modem or a telephone to report a gas leak in the vicinity of the leak.
- A socket outlet should be as close as possible to the unit and easily accessible.
- i.LINK, PC Card, and USB connectors are not supplied with Limited Power Sources.
- To prevent possible damage to your computer during transportation, first attach any supplied connector covers and slot protectors in their appropriate locations, and secure the battery pack in the battery bay.
- Do not use or store your computer in a location subject to: Heat sources, such as radiators or air ducts; direct sunlight; excessive dust; moisture or rain; mechanical vibration or shock; strong magnets or speakers that are not magnetically shielded; ambient temperature higher than 95°F (35°C) or less than 40°F (5°C); and high humidity.
- For safety and/or optimum performance, Sony recommends using genuine Sony rechargeable battery packs.



**To change the backup battery, please contact your nearest Sony Service Center.**

**Caution: The use of optical instruments with this product will increase eye hazard. As the laser beam used in this product is harmful to the eyes, do not attempt to disassemble the cabinet. Refer servicing to qualified personnel only.**

**(For optical drive) Danger: Visible and invisible laser radiation when open. Avoid direct exposure to beam.**

**Caution: To reduce the risk of fire, use only No. 26 AWG or larger telecommunication line cord.**

#### AVERTISSEMENT

- Pour prévenir tout risque d'incendie ou d'électrocution, garder cet appareil à l'abri de la pluie et de l'humidité.
- Pour prévenir tout risque d'électrocution, ne pas ouvrir le châssis de cet appareil et ne confier son entretien qu'à une personne qualifiée.
- Ne jamais effectuer l'installation de fil modem ou téléphone durant un orage électrique.
- Ne jamais effectuer l'installation d'une prise téléphonique dans un endroit mouillé à moins que la prise soit conçue à cet effet.
- Ne jamais toucher un fil téléphonique à découvert ou un terminal à moins que la ligne téléphonique n'ait été débranchée de l'interface réseau.
- Soyez très prudent lorsque vous installez ou modifiez les lignes téléphoniques.
- Évitez d'utiliser le modem durant un orage électrique.
- N'utilisez pas le modem ni le téléphone pour prévenir d'une fuite de gaz quand vous êtes près de la fuite.
- L'appareil doit être le plus près possible d'une prise murale pour en faciliter l'accès.
- Des connecteurs i.LINK, PC Card, et USB ne sont pas fournis avec des Sources d'Énergie Limitées.

- Afin de prévenir des indemnités à votre ordinateur pendant la transportation, attachez d'abord tous les volets de connecteurs et protecteurs d'emplacements comme il faut, et insérez la batterie dans le logement de la batterie.
- Évitez d'utiliser ou de ranger votre ordinateur dans un endroit soumis à: des sources de chaleur telles que des radiateurs ou des bouches d'aération; la lumière directe du soleil; une poussière excessive; l'humidité ou la pluie; des vibrations ou des chocs mécaniques; des aimants puissants ou des haut-parleurs dépourvus de blindage antimagnétique; une température ambiante supérieure à 35 °C (95°F) ou inférieure à 5 °C (40°F); et une forte humidité.
- Pour des raisons de sécurité et/ou de performance, Sony recommande l'utilisation de batteries rechargeables authentiques Sony.



**Pour changer la pile de recharge, veuillez contacter votre centre de service Sony le plus près.**

**Avertissement: L'utilisation d'instruments optiques avec ce produit augmente les risques pour les yeux. Puisque le faisceau laser utilisé dans ce produit est dommageable pour les yeux, ne tentez pas de désassembler le boîtier. Adressez-vous à un agent de service qualifié.**

**(Pour le lecteur optique) Danger: Radiation laser visible et invisible si ouvert. Évitez l'exposition directe au faisceau.**

**Attention : Afin de réduire les risques d'incendie, n'utilisez qu'un cordon de communication NO. 26 AWG ou plus gros.**

If you have questions about this product, you can write to the Sony Customer Information Service Center at 12451 Gateway Blvd., Ft. Myers, FL 33913 or find Sony Customer Service on the Web at: <http://www.sony.com/pcsupport>.

## Regulatory Information

### Declaration of Conformity

Trade Name:	Sony
Model No.:	PCG-8Q1L PCG-8Q2L PCG-8Q3L PCG-8Q4L PCG-8Q5L PCG-8Q6L PCG-8Q7L PCG-8Q8L PCG-8Q9L VGP-PRAV1
Responsible Party:	Sony Electronics Inc.
Address:	16450 W. Bernardo Dr. San Diego, CA 92127 USA
Telephone: (For FCC-related matters only.)	858-942-2230
This device complies with Part 15 of the FCC rules. Operation is subject to the following two conditions:	
(1) This device may not cause harmful interference, and	
(2) this device must accept any interference received, including interference that may cause undesired operation.	

This equipment has been tested and found to comply with the limits for a Class B digital device, pursuant to Part 15 of the FCC Rules. These limits are designed to provide reasonable protection against harmful interference in a residential installation. This equipment generates, uses, and can radiate radio frequency energy and, if not installed and used in accordance with the instructions, may cause harmful interference to radio communications. However, there is no guarantee that interference will not occur in a particular installation. If this equipment does cause harmful interference to radio or television reception, which can be determined by turning the equipment off and on, the user is encouraged to try to correct the interference by one or more of the following measures:

- Reorient or relocate the receiving antenna.
- Increase the separation between the equipment and the receiver.
- Connect the equipment to an outlet on a circuit different from that to which the receiver is connected.
- Consult the dealer or an experienced radio/TV technician for help.

You are cautioned that any changes or modifications to the computer not expressly approved in this manual could void your authority to operate this equipment.

Only peripherals (computer input/output devices, terminals, printers, etc.) that comply with FCC Class B limits may be attached to this computer product. Operation with non-compliant peripherals is likely to result in interference to radio and television reception.

All cables used to connect peripherals must be shielded and grounded. Operation with cables connected to peripherals that are not shielded and grounded may result in interference to radio and television reception.

### FCC Part 68

This equipment complies with Part 68 of the FCC rules and the requirements adopted by the ACTA. On the bottom of this equipment is a label that contains, among other information, a product identifier in the format US:AAAEQ##TXXXX. If requested, this information must be provided to the telephone company.

This modem uses the USOC RJ11C telephone jack.

A telephone plug and jack used to connect this equipment to the premises wiring and telephone network must comply with the applicable FCC Part 68 rules and requirements adopted by the ACTA.

The REN is used to determine the number of devices which may be connected to the telephone line. Excessive RENs on a telephone line may result in the devices not ringing in response to an incoming call. In most, but not all areas, the sum of RENs should not exceed five (5.0). To be certain of the number of devices that may be connected to a line, as determined by the total RENs, contact the telephone company. For products approved after July 23, 2001, the REN for this product is part of the product identifier that has the format US: AAAEQ##TXXXX. The digits represented by ## are the REN without a decimal point (e.g., 03 is a REN of 0.3). For earlier products, the REN is separately shown on the label.



If this equipment causes harm to the telephone network, the telephone company will notify you in advance that temporary discontinuance of service may be required. But if advance notice is not practical, the telephone company will notify the customer as soon as possible. Also, you will be advised of your right to file a complaint with the FCC if you believe it is necessary.

The telephone company may make changes in its facilities, equipment, operations, or procedures that could affect the operation of the equipment. If this happens, the telephone company will provide advance notice in order for you to make the necessary modifications in order to maintain uninterrupted service.

If trouble is experienced with this equipment, for repair or warranty information, please contact 1-888-4-SONY-PC (1-888-476-6972), or write to the Sony Customer Information Service Center, One Sony Drive, Park Ridge, NJ 07656. If the equipment is causing harm to the telephone network, the telephone company may request that you disconnect the equipment until the problem is resolved.

Repair of this equipment should be made only by a Sony Service Center or Sony authorized agent. For a Sony Service Center near you, call 1-888-4-SONY-PC (1-888-476-6972).

Connection to party line service is subject to state tariffs. Contact the state public utility commission, public service commission, or corporation commission for information.

If your home has specially wired alarm equipment connected to the telephone line, ensure the installation of this equipment does not disable your alarm equipment. If you have questions about what will disable alarm equipment, consult your telephone company or a qualified installer.

Use a surge arrester to protect against electrical surges.

### **FCC Radio Frequency Exposure (United States)**

(Applies to Bluetooth and wireless LAN models only)  
This equipment complies with FCC radiation exposure limits set forth for an uncontrolled environment. This equipment should be installed and operated with minimum distance of 8 inches (20 cm) between the radiator and body (excluding extremities: hands, wrists, and feet).

The PCG-8Q1L, PCG-8Q4L, PCG-8Q7L notebook computers contain a Wireless LAN transmitter which is co-located and operating simultaneously with a 0.94 mW Bluetooth module FCC ID: CWTUGPZ5.

This device and its antenna(s) must not be co-located or operating with any other antenna or transmitter except Grant condition.

Users are not permitted to modify these transmitter devices. Any unauthorized change made to this device could void your authority to operate this device.

### **IC RSS-210 (Canada)**

(Applies to Bluetooth and wireless LAN models only)  
Operation is subject to the following two conditions: (1) this device may not cause interference, and (2) this device must accept any interference, including interference that may cause undesired operation of the device.

#### **Wireless mouse**

Carrier frequency 27.045 MHz  
Output power Less than 100 nW

To prevent radio interference to the licensed service, this device is intended to be operated indoors and away from windows to provide maximum shielding. Equipment (or its transmit antenna) that is installed outdoors is subject to licensing.

The term "IC:" before the certification / registration number only signifies that the Industry Canada technical specifications were met.

(S'applique aux modèles sans fil de LAN seulement)  
L'utilisation de ce dispositif est autorisée seulement aux conditions suivantes: (1) il ne doit pas produire de brouillage et (2) l'utilisateur du dispositif doit être prêt à accepter tout brouillage radioélectrique reçu, même si ce brouillage est susceptible de compromettre le fonctionnement du dispositif.

Pour empêcher que cet appareil cause du brouillage au service faisant l'objet d'une licence, il doit être utilisé à l'intérieur et devrait être placé loin des fenêtres afin de fournir un écran de blindage maximal. Si le matériel (ou son antenne d'émission) est installé à l'extérieur, il doit faire l'objet d'une licence.

L'expression "IC:" avant le numéro d'homologation / enregistrement signifie seulement que les spécifications techniques d'Industrie Canada ont été respectées.

### **Telephone Consumer Protection Act of 1991 (United States)**

The Telephone Consumer Protection Act of 1991 makes it unlawful for any person to use a computer or other electronic device, including FAX machines, to send any message unless such message clearly contains in a margin at the top or bottom of each transmitted page or on the first page of the transmission, the date and time it is sent and an identification of the business or other entity, or other individual sending the message, and the telephone number of the sending machine or such business, other entity, or individual. (The telephone number provided may not be a 900 number or any other number for which charges exceed local or long-distance transmission charges.)

In order to program this information into your facsimile machine, see your fax software documentation.

### **Telephone Consumer Guidelines (Canada)**

Please refer to your telephone directory under 'Privacy Issues' and/or 'Terms of Service.' For more detailed information, please contact:

CRTC

Terrasses de la Chaudière, Tour centrale 1 promenade du Portage, 5 étage Hull PQ K1A 0N2.

This Class B digital apparatus complies with Canadian ICES-003.

Cet appareil numérique de la classe B est conforme à la norme NMB-003 du Canada.

### **RECYCLING INFORMATION**

(For customers in the United States) This product contains mercury. Disposal of this product may be regulated if sold in the United States. For disposal or recycling information, please contact your local authorities or the Electronics Industries Alliance (<http://www.eiae.org>).

#### **RECYCLING LITHIUM-ION BATTERIES**

##### **RECYCLING LITHIUM-ION BATTERIES**

Lithium-Ion batteries are recyclable.

You can help preserve our environment by returning your used rechargeable batteries to the collection and recycling location nearest you.



For more information regarding recycling of rechargeable batteries, call toll free 1-800-822-8837, or visit <http://www.rbc.org/>.

Caution: Do not handle damaged or leaking Lithium-Ion batteries.

**RECYCLAGE DES ACCUMULATEURS AUX IONS DE LITHIUM**

RECYCLAGE DES ACCUMULATEURS AUX IONS DE LITHIUM

Les accumulateurs aux ions de lithium sont recyclables.

Vous pouvez contribuer à préserver l'environnement en rapportant les piles usées dans un point de collection et recyclage le plus proche.

Pour plus d'informations sur le recyclage des accumulateurs, téléphonez le numéro gratuit 1-800-822-8837 (Etats-Unis et Canada uniquement), ou visitez <http://www.rbrc.org/>.

Avertissement: Ne pas utiliser des accumulateurs aux ions de lithium qui sont endommagés ou qui fuient.



**Do not handle damaged or leaking lithium ion batteries.**

**Danger of explosion if battery is incorrectly replaced. Replace only with the same or equivalent type recommended by the manufacturer. Discard used batteries according to the manufacturer's instructions.**

**The battery pack used in this device may present a fire or chemical burn hazard if mistreated. Do not disassemble, heat above 140°F (60°C) or incinerate. Dispose of used battery promptly. Keep away from children.**



**Ne pas utiliser des batteries au lithium ionisé qui sont endommagées ou qui fuient.**

**Une batterie non conforme présente un danger d'explosion. La remplacer seulement par une batterie identique ou de type équivalent recommandé par le fabricant. Évacuer les batteries usées selon les directives du fabricant.**

**La manutention incorrecte du module de batterie de cet appareil présente un risque d'incendie ou de brûlures chimiques. Ne pas démonter, incinérer ou exposer à une température de plus de 60°C. Évacuer promptement la batterie usée. Garder hors de portée des enfants.**

**INDUSTRY CANADA NOTICE**

NOTICE: This equipment meets the applicable Industry Canada Terminal Equipment Technical Specifications.

The Ringer Equivalence Number (REN) for this terminal equipment is 0.2. The REN assigned to each terminal equipment provides an indication of the maximum number of terminals allowed to be connected to a telephone interface. The termination on an interface may consist of any combination of devices subject only to the requirement that the sum of the Ringer Equivalence Numbers of all the devices does not exceed five.

**AVIS D'INDUSTRIE CANADA**

REMARQUE: Cet équipement est conforme aux Spécifications Techniques des Équipements Terminaux d'Industrie Canada en vigueur.

Le Nombre Équivalent de Sonneries (REN) de cet équipement terminal est 0,2. Le REN attribué à chaque équipement terminal indique le nombre maximum de terminaux que l'on peut connecter à une interface téléphonique. Il est possible de raccorder à une interface plusieurs combinaisons d'appareils, mais la somme des Nombres Équivalents de Sonneries de tous ces appareils ne doit pas dépasser cinq.



# Setting Up

*Congratulations on your purchase of the Sony VAIO® computer. Sony has combined leading-edge technology in audio, video, computing, and communications to provide state-of-the-art personal computing.*

## Unpacking Your Computer

These hardware components are included.

### Carton Contents

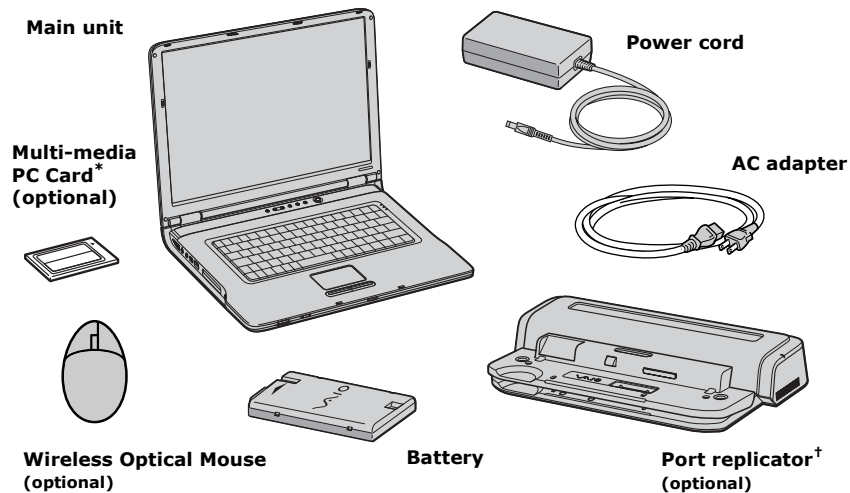

\* See the documentation that accompanied the card for more information.

† Selected models are bundled with the A/V port replicator.

The A/V port replicator is supplied with selected models only. If the computer you purchased comes with an A/V port replicator, the accessories listed on the following page are also included in the carton.

### *A/V Port Replicator Accessories*

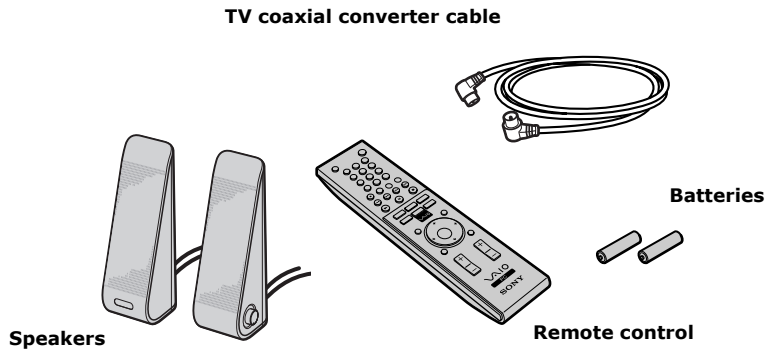

For additional information about the A/V port replicator accessories and how to use them, refer to the VAIO® Computer User Guide.

### **VAIO Computer Documents**

- ❑ **VAIO® Computer User Guide** — A searchable on-screen help file that contains detailed information on how to use your new computer. See “Locating Your VAIO Computer User Guide” on page 33 for more information.
- ❑ **VAIO® Computer Quick Start (this document)** — Contains information on unpacking and setting up your computer for immediate use.
- ❑ **VAIO® Computer Specifications** — An online file that details the hardware specifications and lists the installed programs on your computer. Go to <http://www.sony.com/pcsupport> for more information.

### **Software CDs**

Depending on the model you purchased, additional program CDs may be included with your computer.

### **About System Recovery operations**

Computers with the Microsoft® Windows® XP operating system feature a Hard Disk Drive recovery process that eliminates the need for Recovery CDs.

## Locating Controls and Ports

### Front

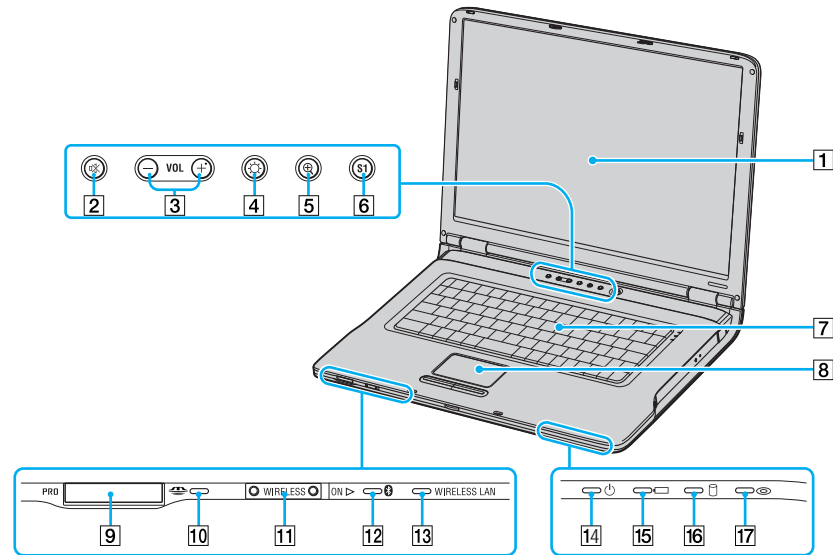

<b>1</b>	LCD screen	<b>10</b>	Memory Stick® media indicator
<b>2</b>	Mute button	<b>11</b>	Wireless switch*
<b>3</b>	Volume buttons	<b>12</b>	Bluetooth® indicator*
<b>4</b>	Brightness button	<b>13</b>	Wireless indicator*
<b>5</b>	Magnify screen button	<b>14</b>	Power indicator
<b>6</b>	S1 button	<b>15</b>	Battery indicator
<b>7</b>	Keyboard	<b>16</b>	Hard disk drive indicator
<b>8</b>	Touch pad	<b>17</b>	Optical drive indicator
<b>9</b>	Memory Stick® media slot†		

\* Wireless LAN and Bluetooth functionality available on selected models only.

† Your computer supports Memory Stick Duo™ media and Memory Stick PRO™ high speed and high capacity capabilities.



Do not insert more than one Memory Stick media into the Memory Stick media slot as it may damage the computer.

Insert the Memory Stick media with the arrow facing up and toward the slot. Inserting the media improperly may damage the computer.

**Front**

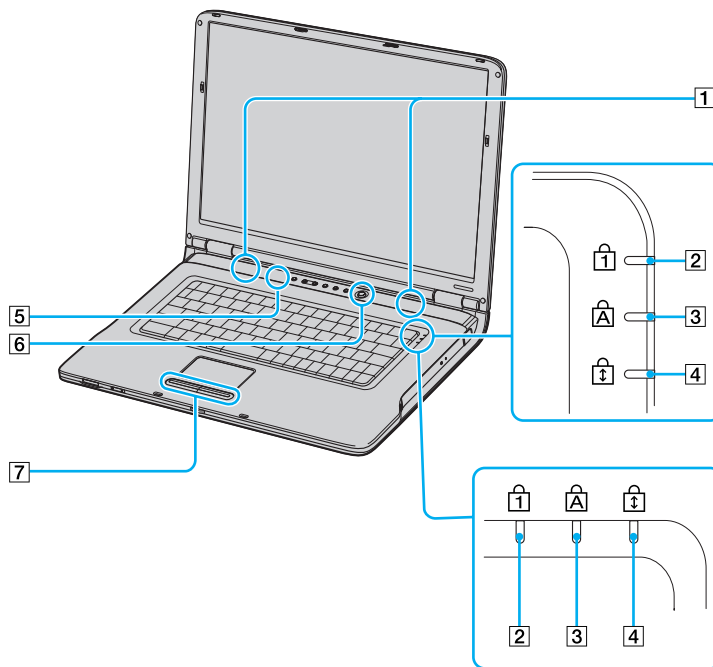

<b>1</b>	Speakers	<b>5</b>	Brightness sensor
<b>2</b>	Num lock indicator*	<b>6</b>	Power button
<b>3</b>	Caps lock indicator*	<b>7</b>	Left and right buttons
<b>4</b>	Scroll lock indicator*		

\* Indicator appears on the top or right corner of the keyboard depending on the model that you purchased.



**Back**

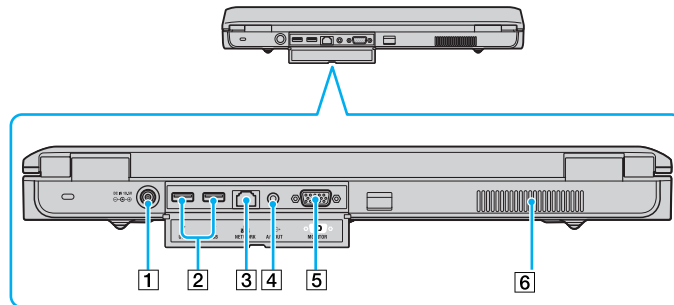

1	⏻ DC In port	4	AV Out jack
2	🔌 USB 2.0 ports*	5	📺 Monitor (VGA) port
3	🌐 Network (Ethernet) port	6	Air vent

\* Supports high-/full-/low- speeds.

**⚠️ Only connect 10BASE-T, 100BASE-TX, 1000BASE-TX cables to the 🌐 Network (Ethernet) port. Do not connect any other type of network cable or any telephone line to this port. Connecting cables other than those listed above may result in an electric current overload and could cause a malfunction, excessive heat, or fire in the port. To connect the unit to a network, refer to your on-screen VAIO® Computer User Guide or contact your network administrator. See “Locating Your VAIO Computer User Guide” on page 33 for more information.**

🖱️ Only selected models support a 1000BASE-TX connection.

*Left*

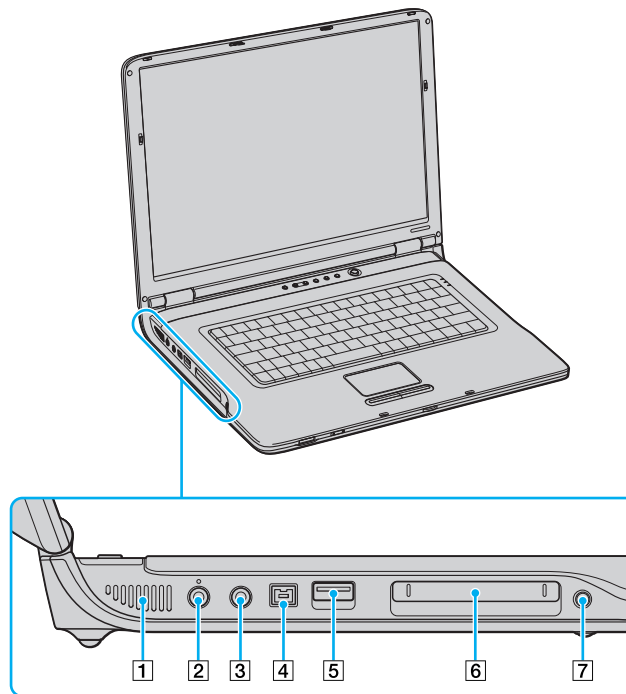

<b>1</b>	Air vent	<b>5</b>	USB 2.0 port*
<b>2</b>	Microphone jack	<b>6</b>	PC Card slot
<b>3</b>	Headphone jack	<b>7</b>	PC Card eject button
<b>4</b>	i.LINK® (IEEE 1394) S400 port		

\* Supports high-/full-/low- speeds.

**Right**

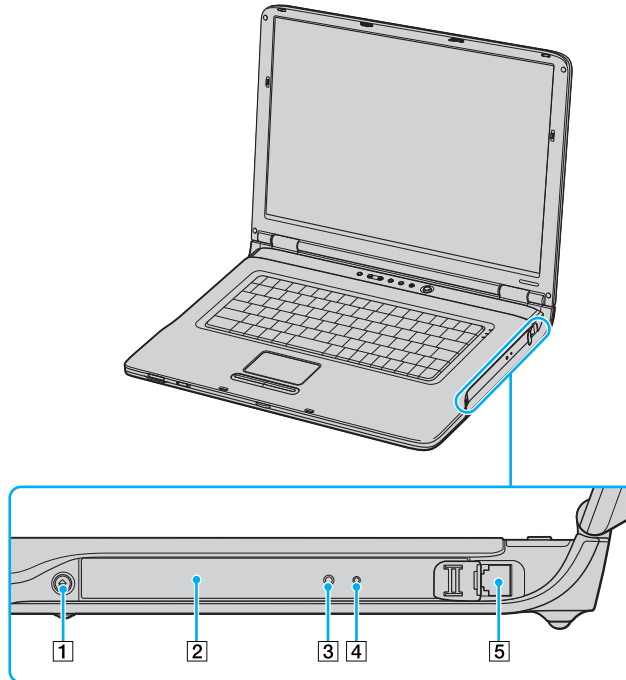

<b>1</b>	Drive eject button	<b>4</b>	Manual eject hole
<b>2</b>	Optical drive	<b>5</b>	Modem jack
<b>3</b>	Drive eject button		

 You can use either drive eject button to eject the optical drive tray. The drive eject button located next to the optical drive functions only with Microsoft® Windows® operating system.

**Bottom**

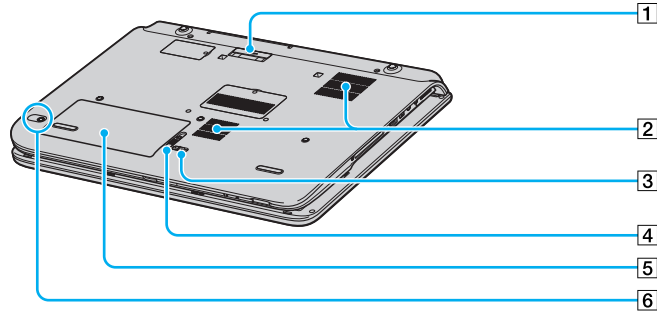

<b>1</b>	Port replicator connector	<b>4</b>	RELEASE switch
<b>2</b>	Air vents	<b>5</b>	Battery bay
<b>3</b>	LOCK/UNLOCK switch	<b>6</b>	CONNECT button*

\* On selected models with wireless mouse functionality.

 See “Connecting a Wireless Mouse” in the Mice and Keyboards chapter of your on-screen VAIO® Computer User Guide for more information about using the wireless optical mouse.

 The printer port on this port replicator is intended for printer connections only.

**A/V Port Replicator**

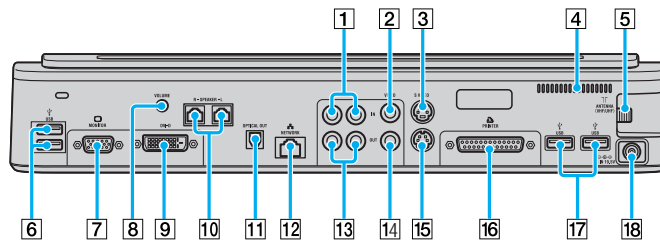

<b>1</b>	Composite Audio In jacks	<b>10</b>	Speaker jacks (right and left)
<b>2</b>	Composite Video In jack	<b>11</b>	Optical Out port Output frequency (48 kHz <sup>*</sup> /44 kHz)
<b>3</b>	S Video In port	<b>12</b>	Network (Ethernet) port (10BASE-T / 100BASE-TX / 1000BASE-TX <sup>†</sup> )
<b>4</b>	Air vent	<b>13</b>	Composite Audio Out jacks
<b>5</b>	VHF/UHF port	<b>14</b>	Composite Video Out jack
<b>6</b>	Ψ USB 2.0 ports <sup>‡</sup>	<b>15</b>	S Video Out port
<b>7</b>	Monitor (VGA) port	<b>16</b>	Printer port
<b>8</b>	Volume jack	<b>17</b>	Ψ USB 2.0 ports <sup>‡</sup>
<b>9</b>	DVI-D port	<b>18</b>	DC IN port

\* Output frequency is 48 kHz for all frequencies except 32 kHz and 44.1 kHz.

† Only selected models support a 1000BASE-TX connection.

‡ Supports high-/full-/low- speeds.

 The printer port on this port replicator is intended for printer connections only.

**Business Port Replicator**

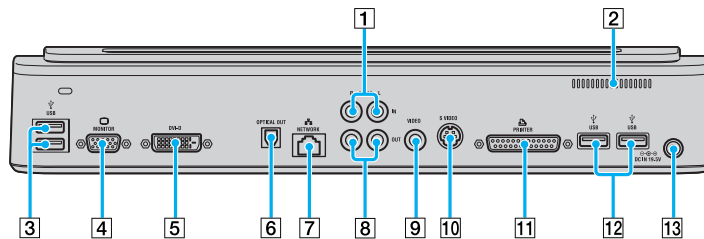







<b>1</b> Composite Audio In jacks	<b>8</b> Composite Audio Out jacks
<b>2</b> Air vent	<b>9</b> Composite Video Out jack
<b>3</b> Ψ USB 2.0 ports *	<b>10</b> S Video Out port
<b>4</b> Monitor (VGA) port	<b>11</b> Printer port
<b>5</b> DVI-D port	<b>12</b> Ψ USB 2.0 ports *
<b>6</b> Optical Out port Output frequency (48 kHz <sup>†</sup> /44 kHz)	<b>13</b> DC IN port
<b>7</b> Network (Ethernet) port (10BASE-T / 100BASE-TX / 1000BASE-TX <sup>‡</sup> )	

\* Supports high-/full-/low- speeds.

<sup>†</sup> Output frequency is 48 kHz for all frequencies except 32 kHz and 44.1 kHz.

<sup>‡</sup> Only selected models support a 1000BASE-TX connection.

## About the Indicator Lights

<i>Indicator</i>	<i>Function</i>
Power 	Turns on when the power to the computer is on, blinks in Standby mode, and turns off when the computer is in Hibernate mode or off.
Battery 	Turns on when the computer is using battery power, blinks when the battery is running out of power, double-blinks when the battery is charging.
Memory Stick® 	Turns on when data is read from or written to the Memory Stick media. (Do not enter Standby mode or turn off the computer when this indicator is on.) When the indicator is off, the Memory Stick media is not being used.
Hard Disk 	Turns on when data is read from or written to the hard disk. Do not enter Standby mode or turn off the computer when this indicator is on.
Num Lock 	Press this key to activate the numeric keypad. Press it a second time to deactivate the numeric keypad. The numeric keypad is not active when the indicator is off.
Caps Lock 	Press this key to type letters in uppercase. Letters appear in lowercase if you press Shift while the indicator is on. Press the key a second time to turn off the indicator. Normal typing resumes when the Caps Lock indicator is off.

<b>Indicator</b>	<b>Function</b>
Scroll Lock 	Press this key to change how you scroll the display. Normal scrolling resumes when the Scroll Lock indicator is off. The Scroll Lock key functions differently depending on the program you are using and does not work with all programs.
Bluetooth®*	Turns on when the wireless switch is set to ON and Bluetooth technology is enabled.
Wireless LAN*	Turns on when the wireless LAN function is running.

\* On selected models only.



# Getting Started

*This section helps you get your computer running and registered, so you can take advantage of Sony's many support options. You'll also learn how to locate your on-screen VAIO® Computer User Guide, which contains step-by-step instructions for operating your computer.*

## **Turning On Your Computer**

To use your computer immediately, use the supplied AC adapter as a power source. Your supplied battery is not charged when you unpack it, however, you can begin charging it when you use your AC adapter. See “Powering Your Computer” in your on-screen VAIO® Computer User Guide for more information about using batteries. See also “Locating Your VAIO Computer User Guide” on page 33.

 Only genuine Sony batteries may be used.

### **To insert and charge the battery**

- 1 First turn the computer over so the bottom panel is facing up.
- 2 Slide the **LOCK/UNLOCK** switch to **UNLOCK**, and then slide the **RELEASE** switch in the direction of the arrow to lift the battery bay cover.

*Opening the Battery Bay*

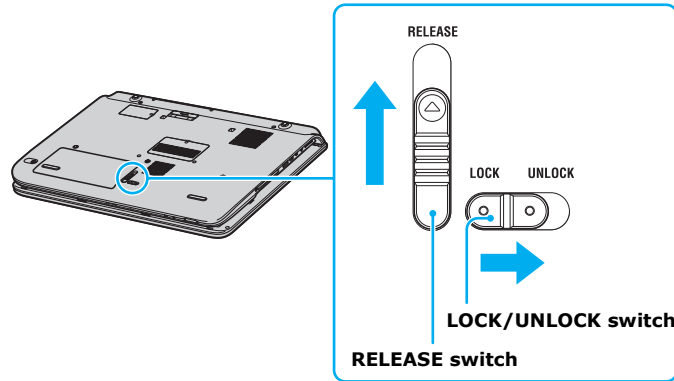

- 3 Slide the battery (with the logo facing up) into the battery bay cover. The two hooks on each side of the battery bay cover should click into the grooves on the battery.

*Inserting the Battery*

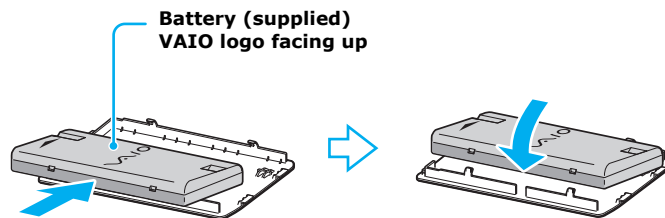

- 4 With the battery securely inserted into the battery bay cover, align the hooks on the battery bay cover with the grooves inside the battery bay.
- 5 Lower the battery into the battery bay until you hear it click.

### *Securing the Battery*

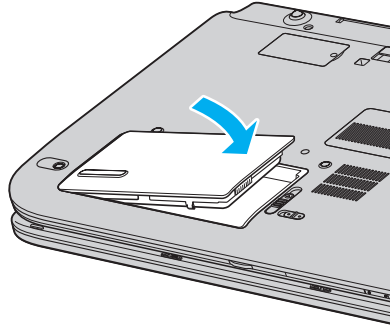

- 6 Slide the **LOCK/UNLOCK** switch to **LOCK**.
- 7 Connect the AC adapter to the computer. See “To connect the AC adapter” on page 28.

 If a port replicator is attached to your computer, do not insert or remove the battery. Lifting and turning the computer with a port replicator attached could cause a temporary loss of power.

Once you connect the AC adapter to the computer, the battery begins to charge whether the computer is on or off. The battery indicator  shows the battery status. The indicator blinks as the battery charges. See “Powering Your Computer” in your on-screen VAIO® Computer User Guide for more information.

**To connect the AC adapter**

- 1 Plug the AC adapter cable into the DC IN port.

**Connecting the AC Adapter to the Computer**

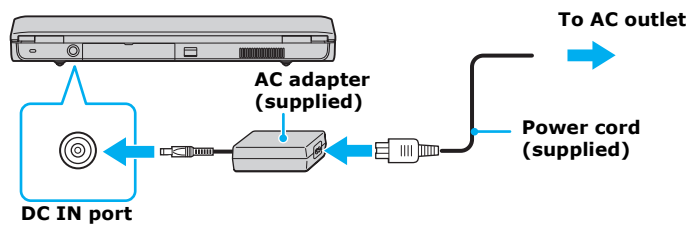

- 2 Plug the power cord into the AC adapter and an AC outlet.

 Use only the supplied AC adapter with your computer.

**To open and turn on the computer**

- 1 Press the release button and lift the cover while holding the bottom of the computer firmly.

**Opening the Computer**

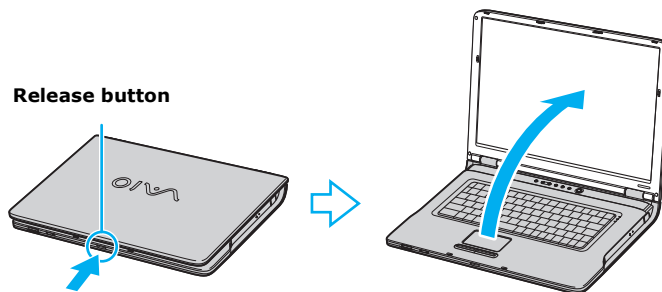

- 2 Press the power button until the green power indicator turns on.

*Turning on the Computer*

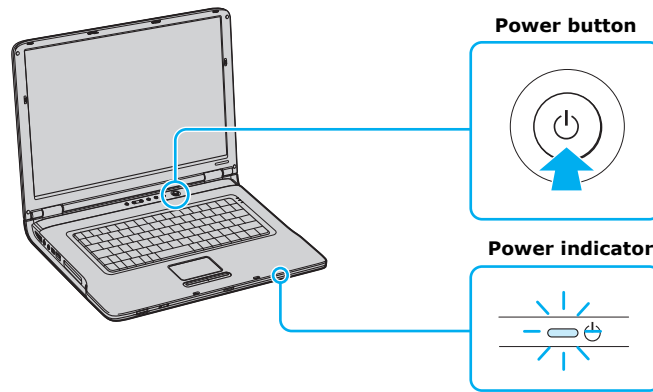

 If you continue to press the power button, the computer turns off.

**3** If necessary, adjust the brightness of the LCD screen.

Your computer comes with a brightness sensor that automatically increases and decreases the LCD screen's brightness level depending on the amount of external light. To override the automatic setting and manually adjust the brightness, follow these steps:

- ❑ Press the Brightness button, located next to the Volume buttons. See “Using Special Buttons” in your on-screen VAIO® Computer User Guide for more information.
- ❑ Press the **Fn** and **F5** keys to decrease the brightness.
- ❑ Press the **Fn** and **F6** keys to increase the brightness.

## **Using the Touch Pad**

The computer contains a pointing device called a touch pad. You can point to, select, drag, and scroll objects on the screen using the built-in touch pad.

### **Describing the touch pad**

#### **Locating the Touch Pad**

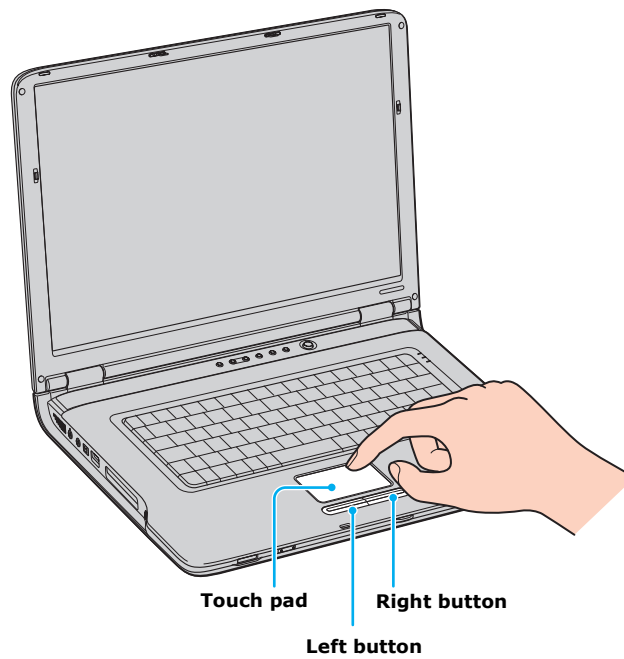

---

<b><i>Touch Pad Action</i></b>	<b><i>Description</i></b>
Sliding one finger	Equivalent to using a mouse to place the pointer on an item.
Tapping once	Equivalent to pressing the left button once.
Tapping twice	Equivalent to pressing the left button twice.
Sliding one finger while pressing the left button	Equivalent to using the mouse to drag an item.
Moving your finger along the right edge of the touch pad	Equivalent to scrolling vertically. (The scroll function is available only with programs that support a touch pad scroll feature.)
Moving your finger along the bottom to scroll horizontally	Equivalent to scrolling horizontally. (The scroll function is available only with programs that support a touch pad scroll feature.)

---

## ***Registering Your Computer***

 You are prompted to register your computer the first time you turn on the unit. Follow the on-screen instructions to complete the registration process. If you are not able to register your computer during the first session, you are provided with additional registration opportunities later.

Take advantage of Sony's commitment to quality customer support and receive these benefits by registering your computer:

- Sony Customer Support** — Talk to a support representative to troubleshoot problems you may have with your computer.
- Limited Warranty Extension** — Protect your investment. See the Warranty Card for more details.
- Product Information Notification** — By giving Sony your contact information, you will enable Sony to reach you regarding performance updates and upgrades.



## Locating Your VAIO Computer User Guide

The on-screen VAIO® Computer User Guide is a searchable help file that contains detailed information on how to use your new computer.

### To open the user guide

- 1 Click **Start** on the Windows® taskbar, and then click **Help and Support**. The **Help and Support Center** window appears, displaying information about your VAIO® computer and Microsoft® Windows® operating system.

### Locating the VAIO User Guide

**User Guide link**

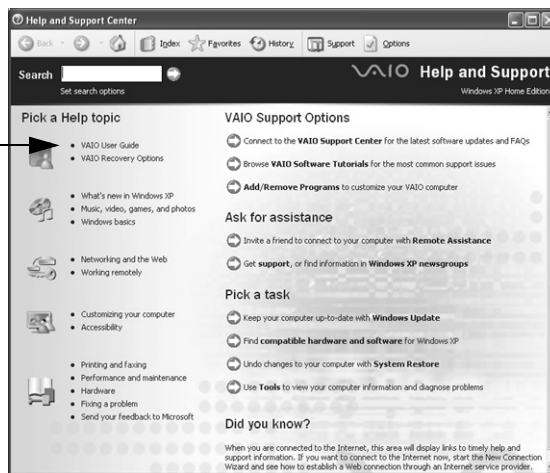

- 2 Click **VAIO User Guide** in the **Pick a Help topic** column. A second **Help and Support Center** window appears with the user guide.

VAIO User Guide Window

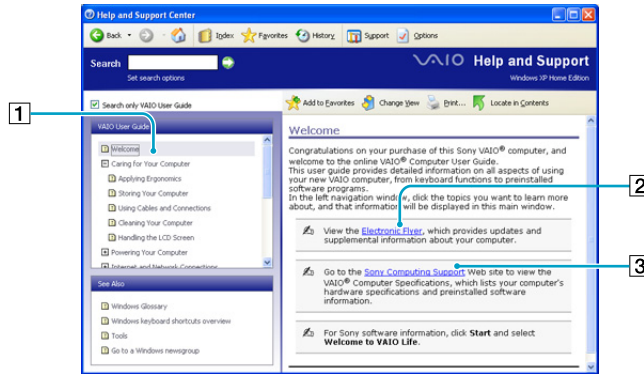

1	User guide table of contents	List of computer help topics
2	Link to Electronic Flyer	List of updates and supplemental information
3	Link to Sony Computing Support Web site	Includes support information and list of your computer's hardware specifications (Internet access required).

## Setting Up A Dial-Up Connection

This section describes the basic steps for setting up your dial-up connection. The Connection Wizard guides you through the process of choosing an Internet Service Provider (ISP) or setting up an existing account, and connecting to the Internet.

### To set up a dial-up connection

- 1 Connect a telephone cable to your computer. See “Setting up a dial-up Internet connection” in the Internet and Network Connections chapter of your on-screen VAIO® Computer User Guide.
- 2 Click **Start**, point to **All Programs, Accessories, Communications**, and then click **New Connection Wizard**. The **New Connection Wizard** appears.

### New Connection Wizard



- 3 Click **Next**.
- 4 If it is not already selected, click **Connect to the Internet**.
- 5 Click **Next**.
- 6 Follow the on-screen instructions.

## ***Turning Off Your Computer***

Using the power button to turn off your computer may result in loss of data. Follow the steps below to properly turn off your computer and avoid losing data.

### ***To turn off your computer***

- 1 Close all operations.
- 2 Click **Start** on the Windows® taskbar.
- 3 Click **Turn Off Computer** at the bottom of the **Start** menu to display the **Turn off computer** window, and select **Turn Off**.

 Respond to any prompts warning you to save documents.

- 4 Wait for your computer to turn off automatically. The computer is off when the power indicator turns off.

 During a period of inactivity, you can conserve battery life by adjusting the power management settings. See “Conserving Battery Power” in your on-screen VAIO® Computer User Guide for more information.

 If you are unable to turn off the computer, press the power button and hold it until the power indicator turns off. This operation may result in data loss.

# VAIO Recovery Wizard Utility

*System and Application Recovery CDs are not supplied with your VAIO® computer. Your VAIO computer is equipped with the VAIO Recovery Wizard, a fast and easy-to-use system recovery utility. This system and application recovery utility enables you to recover preinstalled software programs, recover the operating system, and create a VAIO Recovery Media Kit.*

## **About the VAIO Recovery Wizard utility**

- ❑ Use a variety of recovery options to restore your preinstalled software programs and specific partitions on your hard disk drive.
- ❑ Follow the instructions that guide you through various recovery options, choosing the default selections or customizing your computer's recovery.
- ❑ Discover the advantages of recovering your computer without using CDs or other external media.
- ❑ Create your own Recovery Media Kit, using your own CD or DVD media.

## **Creating a Recovery Media Kit**

You can create a VAIO Recovery Media Kit using your own blank CDs and DVDs\*, which enables you to recover your computer at a later date in the event the computer's operating system fails. The Recovery Media Kit also enables you to reclaim the portion of your hard disk drive space reserved for the recovery partition.

For more information about creating the Recovery Media Kit, see the VAIO Recovery Options online guide:

- 1 Click **Start** in the Windows® taskbar, and click **Help and Support**. The **VAIO Help and Support Center** window appears.

---

\* The number of CDs and/or DVDs required to create a Recovery Media Kit varies, depending on the computer model purchased.

- 2 In the **VAIO Help and Support Center** window, click **VAIO Recovery Options**.

The VAIO Recovery Options online guide appears.

Visit the Sony Online Support Web site for the latest information about using the VAIO Recovery Wizard and Recovery Media Kit.

Go to <http://www.ita.sel.sony.com/support/news/hddrecovery.html>.

### ***To purchase a VAIO Recovery Media kit***

- 1 Visit the Sony Online Support page for the VAIO® Recovery Wizard at:  
<http://www.ita.sel.sony.com/support/news/hddrecovery.html>
- 2 Follow the on-screen instructions to order a Recovery Media Kit.



If you are not able to access the Sony Direct Accessories and Parts Center Web site, contact a customer service representative at 1-800-488-7669.

### ***Using the VAIO Recovery Wizard Help***

For more information about recovery options and instructions on using the VAIO Recovery Wizard utility program, see the VAIO Recovery Wizard Help.

Access the Help by following these steps:

- 1 Click **Start** in the Microsoft® Windows® taskbar, and click **All Programs**.
- 2 Click **VAIO Recovery Wizard**.  
The **VAIO Recovery Wizard** utility appears.
- 3 Click **Help**.  
The **VAIO Recovery Wizard Help** appears in a separate window\*.

---

\* Even if you do not perform a recovery operation, your system prompts you to restart your computer when you close the VAIO Recovery Wizard utility.

# Troubleshooting

## ***What do I do if my computer won't start?***

- ❑ Make sure the computer is securely plugged into a power source and turned on. Make sure the power indicator shows the power is on.
- ❑ Make sure the battery is inserted properly and charged.
- ❑ Make sure the floppy disk drive (if applicable) is empty.
- ❑ If the computer is plugged into a power strip or uninterruptible power supply (UPS), make sure the power strip or UPS is turned on and working.
- ❑ If you are using an external display, make sure it is plugged into a power source and turned on. Make sure the brightness and contrast controls are adjusted correctly. See the guide that came with your display for details.
- ❑ Disconnect the AC adapter and remove the battery. Wait three to five minutes. Reattach the AC adapter and reinsert the battery, and press the Power button to turn on the computer.
- ❑ Condensation may cause the computer to malfunction. If this occurs, do not use the computer for at least one hour.



For further instructions, contact Sony Computing Support (<http://www.sony.com/pcsupport>).

## ***What do I do if a BIOS error appears when my computer starts?***

If the message “Press <F1> to resume, <F2> to setup” appears at the bottom of the screen, follow these steps:

- 1 Press the **F2** key. The **BIOS Setup** menu appears.
- 2 Set the date (month/day/year). Press **Enter**.
- 3 Press the **Down Arrow** key **↓** to select **System Time**, and then set the time (hour: minute: second). Press **Enter**.

- 4 Press the **Right Arrow** key → to select the **Exit** tab, and then press the **Down Arrow** key ↓ to select **Get Default Values**. The message **Load factory default values**. appears.
- 5 Press the **Enter** key. The **Load Optimal Defaults?** window appears.
- 6 Select **Ok**, and press **Enter**.
- 7 Select **Exit (Save Changes)**, and press **Enter**. The **Save configuration changes and exit setup?** window appears.
- 8 Select **Ok**, and press **Enter**. The computer restarts.



If this occurs on a regular basis, contact Sony Computing Support (<http://www.sony.com/pcsupport>).

***What do I do if the message “Operating system not found” appears when my computer starts, and why won’t Windows start?***

- Make sure the computer does not have a “non-bootable” floppy disk in the floppy disk drive (if applicable).
- If a non-bootable floppy disk is in the drive:
  - 1 Remove the floppy disk.
  - 2 Restart the computer and confirm that the Microsoft® Windows® operating system starts properly.
- If the Windows operating system still does not start, follow these steps to initialize the BIOS:
  - 1 If there is a disk in the floppy disk drive, then remove it.
  - 2 Turn off the computer.
  - 3 Remove any peripheral devices connected to the computer.
  - 4 Restart the computer.
  - 5 Press the **F2** key when the Sony logo appears. The **BIOS Setup** window appears.
  - 6 Press the **Right Arrow** key → to select the **Exit** menu.
  - 7 Press the **Down Arrow** key ↓ to select **Get Default Values**. The message **Load factory default values**. appears.



- 8 Press the **Enter** key. The **Load Optimal Defaults?** window appears.
- 9 Select **Ok**, and press **Enter**.
- 10 Select **Exit (Save Changes)**, and press **Enter**. The **Save configuration changes and exit setup?** window appears.
- 11 Select **Ok**, and press **Enter**. The computer restarts.

### ***What do I do if my computer stops responding?***

It is best to turn off your computer using the Turn Off Computer option on the Microsoft® Windows® Start menu, located on the taskbar. Using other methods, including those listed below, may result in loss of unsaved data.

- Click **Start** on the Windows® taskbar, select **Turn Off Computer**, and then click **Turn Off**.
- If your computer does not turn off, press the **Ctrl+Alt+Delete** keys simultaneously. When the **Windows Task Manager** dialog box appears, click **Turn Off** from the **Shut Down** menu.
- If your computer still does not turn off, press and hold the power button or slide and hold the power switch until the computer turns off.
- If your computer stops responding while playing a CD or DVD, press the **Ctrl+Alt+Delete** keys simultaneously. You can turn off the computer from the **Windows Task Manager**.

 Pressing the **Ctrl+Alt+Delete** keys simultaneously or turning off the computer with the power button or switch may cause loss of data.

- Remove the AC adapter and battery.

## **Support Options**

If you have questions about your computer or the preinstalled programs, refer to the following sources for answers in the sequence listed below.

- 
- 1 VAIO® Computer User Guide**  
The on-screen VAIO® Computer User Guide provides detailed information on how to maximize your computer capabilities and solve common problems.

---

  - 2 Program Guides and Help Files**  
The preinstalled programs on your computer may come with individual help guides. These guides are stored on the hard disk as on-screen Help files. You can find the Help files from the Help menu under the specific program.

---

  - 3 Operating System Online Support**  
Your computer comes preinstalled with a Microsoft® Windows® operating system. For operating system support, you can visit Microsoft® customer support at: <http://support.microsoft.com/directory/>.

---

  - 4 Sony Computing Support**  
This service provides instant access to information on commonly encountered problems. Type a description of the problem and the Knowledge Database searches for the corresponding solutions online. You can visit Sony Computing Support at:  
<http://www.sony.com/pcsupport>.

---

  - 5 VAIO Update**  
When your computer is connected to the Internet, VAIO Update automatically notifies you when critical software and security information is posted on the support Web site. Click the VAIO Update notice to open the VAIO Support Web site and view the information. You can also right-click the **VAIO Update** icon  in the **Taskbar Notification** area and select **Go to VAIO Web Support** to open the support Web site.
-





For customer support information, go to:  
<http://www.sony.com/pcsupport>

VAIO Homepage  
<http://www.vaio.net>  
© 2004 Sony Electronics Inc.  
Printed in USA  
2-055-913-01