













Personal Computer  
VGN-S380, VGN-S380P,  
VGN-S380B  
Quick Start

**SONY**<sup>®</sup>

## Shortcut Menu

 +F1	Displays the VAIO Help and Support Center window.
 +Tab	Switches the selected button on the taskbar.
 +D	Displays the desktop.
 +E	Displays the My Computer window.
 +F	Displays the Search Results window, where you can find a file or folder. This is the equivalent of selecting Search from the Start menu.
 +Ctrl+F	Displays the Search Results - Computers window, where you can locate other computers. This is the equivalent of selecting Search, and then Computer from the Start menu.
 +M	Minimizes all displayed windows.
Shift+  +M	Returns all minimized windows to their previous size.
 +R	Displays the Run window. This is the equivalent of selecting Run from the Start menu.
Fn+  +Insert	Displays the System Properties window. This is the equivalent of selecting Control Panel, and then System from the Start menu.
Fn+F2	Toggles the headphones and built-in speakers off and on.
Fn+F3	Decreases the speaker volume.
Fn+F4	Increases the speaker volume.
Fn+F5	Decreases the LCD screen brightness.
Fn+F6	Increases the LCD screen brightness.
Fn+F7	Toggles the display between the computer screen (LCD), a connected external display, and both the LCD and an external display.
Fn+F12	Puts the system into Hibernate mode, a power management state. To return the system to normal operating mode, press the power button.

# Contents

<b>Notice to Users .....</b>	<b>5</b>
<b>Setting Up .....</b>	<b>13</b>
Unpacking Your Computer .....	13
Locating Controls and Ports .....	15
About the Indicator Lights .....	21
<b>Getting Started .....</b>	<b>23</b>
Turning On Your Computer .....	23
Using the Touch Pad .....	28
Registering Your Computer .....	29
Locating Your VAIO Computer User Guide .....	30
Setting Up A Dial-Up Connection .....	32
Turning Off Your Computer .....	35
<b>Troubleshooting .....</b>	<b>37</b>
Support Options.....	40



# Notice to Users

© 2005 Sony Electronics Inc. All rights reserved. This manual and the software described herein, in whole or in part, may not be reproduced, translated, or reduced to any machine-readable form without prior written approval.

SONY ELECTRONICS INC. PROVIDES NO WARRANTY WITH REGARD TO THIS MANUAL, THE SOFTWARE, OR OTHER INFORMATION CONTAINED HEREIN AND HEREBY EXPRESSLY DISCLAIMS ANY IMPLIED WARRANTIES OF MERCHANTABILITY OR FITNESS FOR ANY PARTICULAR PURPOSE WITH REGARD TO THIS MANUAL, THE SOFTWARE, OR SUCH OTHER INFORMATION. IN NO EVENT SHALL SONY ELECTRONICS INC. BE LIABLE FOR ANY INCIDENTAL, CONSEQUENTIAL, OR SPECIAL DAMAGES, WHETHER BASED ON TORT, CONTRACT, OR OTHERWISE, ARISING OUT OF OR IN CONNECTION WITH THIS MANUAL, THE SOFTWARE, OR OTHER INFORMATION CONTAINED HEREIN OR THE USE THEREOF.

Sony Electronics Inc. reserves the right to make any modification to this manual or the information contained herein at any time without notice. The software described herein is governed by the terms of a separate user license agreement.

This product contains software owned by Sony and licensed by third parties. Use of such software is subject to the terms and conditions of license agreements enclosed with this product. Some of the software may not be transported or used outside the United States. Software specifications are subject to change without notice and may not necessarily be identical to current retail versions.

Updates and additions to software may require an additional charge. Subscriptions to online service providers may require a fee and credit card

information. Financial services may require prior arrangements with participating financial institutions.

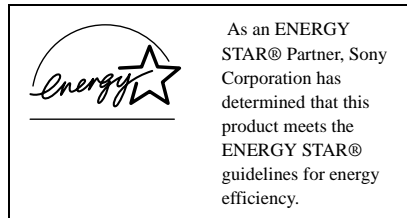

The International ENERGY STAR® Office Equipment Program is an international program that promotes energy saving through the use of computers and other office equipment. The program backs the development and dissemination of products with functions that effectively reduce energy consumption. It is an open system in which business proprietors can participate voluntarily. The targeted products are office equipment such as computers, displays, printers, facsimiles and copiers. Their standards and logos are uniform among participating nations. ENERGY STAR is a U.S. registered mark.

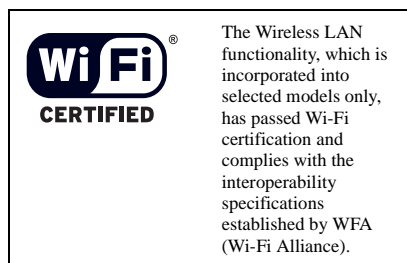

Sony, Click to DVD, DVgate, DVgate Plus, Handycam, i.LINK, Mavica, MagicGate Memory Stick, Memory Stick, Memory Stick PRO, PictureGear Studio, SonicStage, VAIO, and the VAIO logo are trademarks of Sony Corporation. Microsoft, Windows

Media, Windows, Windows NT, and the Windows logo are registered trademarks of Microsoft Corporation. Intel, Intel SpeedStep, and Pentium are trademarks or registered trademarks of Intel Corporation. PS/2 is a registered trademark of IBM. Acrobat Reader, Photoshop, Photoshop Elements, and Premiere are trademarks of Adobe Systems Incorporated.

Reverse engineering or disassembly is prohibited. i.LINK is a trademark of Sony used only to designate that a product contains an IEEE 1394 connection. The i.LINK connection may vary, depending on the software applications, operating system, and compatible i.LINK devices. All products with an i.LINK connection may not communicate with each other. Please refer to the documentation that came with your compatible i.LINK device for information on operating conditions and proper connection. Before connecting compatible i.LINK PC peripherals to your system, such as a CD-RW or hard disk drive, confirm their operating system compatibility and required operating conditions. All other trademarks are trademarks of their respective owners.

### **End User / Product Activation Requirements**

Certain software product(s) included with this computer may include features such as copy protection and content management technology. Use of the software product(s) requires agreement to applicable end user agreements and full compliance with applicable product activation procedures. Product activation procedures and privacy policies will be detailed during initial launch of the software product(s), or upon certain reinstallations of the software product(s) or reconfiguration of the computer, and may be completed by Internet or telephone (toll charges may apply).

### **Owner's Record**

The model number and serial number are located on the bottom of your Sony VAIO computer. Refer to the model and serial number when you call your Sony Service Center.

Model Number: \_\_\_\_\_  
Serial Number: \_\_\_\_\_

## **Safety Information**

### **WARNING**

- To prevent fire or shock hazard, do not expose your computer to rain or moisture.
- To avoid electrical shock, do not open the cabinet. Refer servicing to qualified personnel only.
- Never install modem or telephone wiring during a lightning storm.
- Never install telephone jacks in wet locations unless the jack is specifically designed for wet locations.
- Never touch uninsulated telephone wire or terminals unless the telephone line has been disconnected at the network interface.
- Use caution when installing or modifying telephone lines.
- Avoid using the modem during an electrical storm.
- Do not use the modem or a telephone to report a gas leak in the vicinity of the leak.
- A socket outlet should be as close as possible to the unit and easily accessible.
- i.LINK, PC Card, and USB connectors are not supplied with Limited Power Sources.
- To prevent possible damage to your computer during transportation, first attach any supplied connector covers and slot protectors in their appropriate locations, and secure the battery pack in the battery bay.
- Do not use or store your computer in a location subject to: Heat sources, such as radiators or air ducts; direct sunlight; excessive dust; moisture or rain; mechanical vibration or shock; strong magnets or speakers that are not magnetically shielded; ambient temperature higher than 95°F (35°C) or less than 40°F (5°C); and high humidity.
- This computer is designed to operate only with genuine Sony batteries.
- Do not use wireless LAN on hospital premises. Doing so may cause medical devices to malfunction.

- Do not use wireless LAN on an aircraft, as doing so may cause the aircraft's equipment to malfunction.
- If using wireless LAN near a pacemaker, make sure it is at least 9 inches (22cm) away from the pacemaker.



**To change the backup battery, please contact your nearest Sony Service Center.**

**Caution: The use of optical instruments with this product will increase eye hazard. As the laser beam used in this product is harmful to the eyes, do not attempt to disassemble the cabinet. Refer servicing to qualified personnel only.**

**(For CD-RW/DVD-ROM and DVD-RW drives) Danger: Class 3B visible and invisible laser radiation when open. Avoid direct exposure to beam.**

**Caution: To reduce the risk of fire, use only No. 26 AWG or larger telecommunication line cord.**

### Wireless LAN Security

Creating security settings for the wireless LAN is extremely important. Sony assumes no responsibility for any security problems that may arise from the use of the wireless LAN.

#### AVERTISSEMENT

- Pour prévenir tout risque d'incendie ou d'électrocution, garder cet appareil à l'abri de la pluie et de l'humidité.
- Pour prévenir tout risque d'électrocution, ne pas ouvrir le châssis de cet appareil et ne confier son entretien qu'à une personne qualifiée.
- Ne jamais effectuer l'installation de fil modem ou téléphone durant un orage électrique.
- Ne jamais effectuer l'installation d'une prise téléphonique dans un endroit mouillé à moins que la prise soit conçue à cet effet.
- Ne jamais toucher un fil téléphonique à découvert ou un terminal à moins que la ligne téléphonique n'ait été débranchée de l'interface réseau.

- Soyez très prudent lorsque vous installez ou modifiez les lignes téléphoniques.
- Évitez d'utiliser le modem durant un orage électrique.
- N'utilisez pas le modem ni le téléphone pour prévenir d'une fuite de gaz quand vous êtes près de la fuite.
- L'appareil doit être le plus près possible d'une prise murale pour en faciliter l'accès.
- Des connecteurs i.LINK, PC Card, et USB ne sont pas fournis avec des Sources d'Énergie Limitées.
- Afin de prévenir des indemnités à votre ordinateur pendant la transportation, attachez d'abord tous les volets de connecteurs et protecteurs d'emplacements comme il faut, et insérez la batterie dans le logement de la batterie.
- Évitez d'utiliser ou de ranger votre ordinateur dans un endroit soumis à: des sources de chaleur telles que des radiateurs ou des bouches d'aération; la lumière directe du soleil; une poussière excessive; l'humidité ou la pluie; des vibrations ou des chocs mécaniques; des aimants puissants ou des haut-parleurs dépourvus de blindage antimagnétique; une température ambiante supérieure à 35 °C (95°F) ou inférieure à 5 °C (40°F); et une forte humidité.
- Cet ordinateur est conçu pour fonctionner uniquement avec des batteries Sony.
- Ne pas utiliser le réseau local sans fil dans les hôpitaux car cela risquerait de provoquer le mauvais fonctionnement des appareils médicaux.
- Ne pas utiliser le réseau local sans fil dans un avion car cela risquerait de provoquer le mauvais fonctionnement des appareils de vol.
- Si vous utilisez le réseau local sans fil à proximité d'un stimulateur cardiaque, assurez-vous qu'il est au moins à 9 po (22 cm) du stimulateur cardiaque.



Pour changer la pile de recharge, veuillez contacter votre centre de service Sony le plus près.

**Avertissement: L'utilisation d'instruments optiques avec ce produit augmente les risques pour les yeux. Puisque le faisceau laser utilisé dans ce produit est dommageable pour les yeux, ne tentez pas de désassembler le boîtier. Adressez-vous à un agent de service qualifié.**

**(Pour le lecteurs Combo de CD-RW/DVD-ROM et DVD-RW) Danger: Radiation laser visible et invisible si ouvert. Évitez l'exposition directe au faisceau.**

**Attention : Afin de réduire les risques d'incendie, n'utilisez qu'un cordon de communication NO. 26 AWG ou plus gros.**

### Sécurité du réseau local sans fil

La création de paramètres de sécurité pour le réseau local sans fil est extrêmement importante. Sony n'est pas tenu responsable des problèmes de sécurité susceptibles de se produire lors de l'utilisation du réseau local sans fil.

If you have questions about this product, you can reach the Sony Customer Information Service Center at 1-888-4-SONY-PC; or write to the Sony Customer Information Service Center at 12451 Gateway Blvd., Ft. Myers, FL 33913 or find Sony Customer Service on the Web at: <http://www.sony.com/pcsupport>.

## Regulatory Information

### Declaration of Conformity

Trade Name:	Sony
Model No.:	PCG-6E1L PCG-6E2L PCG-6E3L PCG-6E4L PCG-6E5L
Responsible Party:	Sony Electronics Inc.
Address:	16450 W. Bernardo Dr. San Diego, CA 92127 USA
Telephone: (For FCC-related matters only.)	858-942-2230

This device complies with Part 15 of the FCC rules. Operation is subject to the following two conditions:

- (1) This device may not cause harmful interference, and
- (2) this device must accept any interference received, including interference that may cause undesired operation.

This equipment has been tested and found to comply with the limits for a Class B digital device, pursuant to Part 15 of the Rules. These limits are designed to provide reasonable protection against harmful interference in a residential installation. This equipment generates, uses, and can radiate radio frequency energy and, if not installed and used in accordance with the instructions, may cause harmful interference to radio communications. However, there is no guarantee that interference will not occur in a particular installation. If this equipment does cause harmful interference to radio or television reception, which can be determined by turning the equipment off and on, the user is encouraged to try to correct the interference by one or more of the following measures:

- Reorient or relocate the receiving antenna.
- Increase the separation between the equipment and the receiver.



- ❑ Connect the equipment to an outlet on a circuit different from that to which the receiver is connected.
- ❑ Consult the dealer or an experienced radio/TV technician for help.

You are cautioned that any changes or modifications to the computer not expressly approved in this manual could void your authority to operate this equipment.

Only peripherals (computer input/output devices, terminals, printers, etc.) that comply with FCC Class B limits may be attached to this computer product. Operation with non-compliant peripherals is likely to result in interference to radio and television reception.

All cables used to connect peripherals must be shielded and grounded. Operation with cables connected to peripherals that are not shielded and grounded may result in interference to radio and television reception.

### **FCC Part 68**

This equipment complies with Part 68 of the FCC rules and the requirements adopted by the ACTA. On the bottom of this equipment is a label that contains, among other information, a product identifier in the format US:AAAEQ##TXXXX. If requested, this information must be provided to the telephone company.

This modem uses the USOC RJ11C telephone jack. A telephone plug and jack used to connect this equipment to the premises wiring and telephone network must comply with the applicable FCC Part 68 rules and requirements adopted by the ACTA.

The REN is used to determine the number of devices which may be connected to the telephone line. Excessive RENs on the telephone line may result in the devices not ringing in response to an incoming call. In most, but not all areas, the sum of the RENs should not exceed five (5.0). To be certain of the number of devices that may be connected to the line, as determined by the total RENs, contact the telephone company to determine the maximum REN for the calling area. For products approved after July 23, 2001, the REN for this product is part of the product identifier that has the format US: AA AEQ##TXXXX. The digits represented by ## are the REN without a decimal point (e.g., 03 is a REN of 0.3). For earlier products, the REN is separately shown on the label.

If this equipment causes harm to the telephone network, the telephone company will notify you in advance that temporary discontinuance of service may be required. If advance notice is not practical, the telephone company will notify the customer as soon as

possible. Also, you will be advised of your right to file a complaint with the FCC if you believe it is necessary.

The telephone company may make changes in its facilities, equipment, operations or procedures that could affect the operations of the equipment. If this happens, the telephone company will provide advance notice in order for you to make the necessary modifications in order to maintain uninterrupted service.

If trouble is experienced with this equipment, you can reach the Sony Customer Information Service Center at 1-888-4-SONY-PC, or write to the Sony Customer Information Service Center at 12451 Gateway Blvd., Ft. Myers, FL 33913; or find Sony Customer Service on the Web at: <http://www.sony.com/pcsupport>. If the equipment is causing harm to the telephone network, the telephone company may request that you disconnect the equipment until the problem is resolved.

Repair of this equipment should be made only by a Sony Service Center or Sony authorized agent. For the Sony Service Center nearest you, call 1-888-4-SONY-PC (1-888-476-6972).

This equipment cannot be used on public coin service provided by the telephone company. Connection to party line service is subject to state and possible provincial tariffs. Contact the state public or provincial utility service commission, public service commission, or corporation commission for information.

If your home has specially wired alarm equipment connected to the telephone line, ensure the installation of this equipment does not disable your alarm equipment. If you have questions about what will disable alarm equipment, consult your telephone company or a qualified installer.

Use a surge arrester to protect against electrical surges.

### **FCC Radio Frequency Exposure (United States)**

(For models with wireless LAN) This equipment complies with FCC radiation exposure limits set forth for an uncontrolled environment. This equipment should be installed and operated with minimum distance of 8 inches (20 cm) between the radiator and body (excluding extremities: hands, wrists, and feet).

The PCG-6E1L and PCG-6E3L notebook computers contain a Wireless LAN transmitter which is co-located and operating simultaneously with a 0.94 mW Bluetooth module FCC ID: CWTUGPZ5.

This device and its antenna(s) must not be co-located or operating with any other antenna or transmitter

except Grant condition. Users are not permitted to modify this transmitter device. Any unauthorized change made to this device could void your authority to operate this device.

### **IC RSS-210 (Canada)**

Operation is subject to the following two conditions: (1) this device may not cause interference, and (2) this device must accept any interference, including interference that may cause undesired operation of the device.

To prevent radio interference to the licensed service, this device is intended to be operated indoors and away from windows to provide maximum shielding. Equipment (or its transmit antenna) that is installed outdoors is subject to licensing.

The term "IC:" before the certification/registration number only signifies that the Industry Canada technical specifications were met.

Sony is not responsible for any interference that you may experience or that may be caused when operating this device.

L'utilisation de ce dispositif est autorisée seulement aux conditions suivantes: (1) il ne doit pas produire de brouillage et (2) l'utilisateur du dispositif doit être prêt à accepter tout brouillage radioélectrique reçu, même si ce brouillage est susceptible de compromettre le fonctionnement du dispositif.

Pour empêcher que cet appareil cause du brouillage au service faisant l'objet d'une licence, il doit être utilisé à l'intérieur et devrait être placé loin des fenêtres afin de fournir un écran de blindage maximal. Si le matériel (ou son antenne d'émission) est installé à l'extérieur, il doit faire l'objet d'une licence.

L'expression "IC:" avant le numéro d'homologation/enregistrement signifie seulement que les spécifications techniques d'Industrie Canada ont été respectées.

Sony n'est pas responsable des interférences que vous risquez de rencontrer ou qui risquent d'être provoquées lors du fonctionnement de cet appareil.

### **Telephone Consumer Protection Act of 1991 (United States)**

The Telephone Consumer Protection Act of 1991 makes it unlawful for any person to use a computer or other electronic device, including fax machines, to send any message unless such message clearly contains, in a margin at the top or bottom of each transmitted page or on the first page of the transmission, the date and time it is sent and an identification of the business, other entity, or individual sending the message, and the telephone number of the sending machine or such business, other entity, or individual. (The telephone number provided may not be a 900 number or any other number for which charges exceed local or long-distance transmission charges.)

In order to program this information into your facsimile machine, see your fax software documentation.

### **Telephone Consumer Guidelines (Canada)**

Please refer to your telephone directory under 'Privacy Issues' and/or 'Terms of Service.' For more detailed information, please contact:

CRTC  
Terrasses de la Chaudière, Tour centrale 1 promenade du Portage, 5 étage Hull PQ K1A 0N2.

This Class B digital apparatus complies with Canadian ICES-003.

Cet appareil numérique de la classe B est conforme à la norme NMB-003 du Canada.

## RECYCLING INFORMATION

(For customers in the United States) This product contains mercury. Disposal of this product may be regulated if sold in the United States. For disposal or recycling information, please contact your local authorities or the Electronics Industries Alliance (<http://www.eiae.org>).

### RECYCLING LITHIUM-ION BATTERIES

#### RECYCLING LITHIUM-ION BATTERIES

Lithium-Ion batteries are recyclable.

You can help preserve our environment by returning your used rechargeable batteries to the collection and recycling location nearest you.

For more information regarding recycling of rechargeable batteries, call toll free 1-800-822-8837, or visit <http://www.rbrc.org/>.

Caution: Do not handle damaged or leaking Lithium-Ion batteries.



## RECYCLAGE DES ACCUMULATEURS AUX IONS DE LITHIUM

#### RECYCLAGE DES ACCUMULATEURS AUX IONS DE LITHIUM

Les accumulateurs aux ions de lithium sont recyclables.

Vous pouvez contribuer à préserver l'environnement en rapportant les piles usées dans un point de collection et recyclage le plus proche.

Pour plus d'informations sur le recyclage des accumulateurs, téléphonez le numéro gratuit 1-800-822-8837 (Etats-Unis et Canada uniquement), ou visitez <http://www.rbrc.org/>.

Avertissement: Ne pas utiliser des accumulateurs aux ions de lithium qui sont endommagés ou qui fuient.



**Do not handle damaged or leaking lithium ion batteries.**

**Danger of explosion if battery is incorrectly replaced. Replace only with the same or equivalent type recommended by the manufacturer. Discard used batteries according to the manufacturer's instructions.**

**The battery pack used in this device may present a fire or chemical burn hazard if mistreated. Do not disassemble, heat above 140°F (60°C) or incinerate. Dispose of used battery promptly. Keep away from children.**



**Ne pas utiliser des batteries au lithium ionisé qui sont endommagées ou qui fuient.**

**Une batterie non conforme présente un danger d'explosion. La remplacer seulement par une batterie identique ou de type équivalent recommandé par le fabricant. Évacuer les batteries usées selon les directives du fabricant.**

**La manutention incorrecte du module de batterie de cet appareil présente un risque d'incendie ou de brûlures chimiques. Ne pas démonter, incinérer ou exposer à une température de plus de 60°C. Évacuer promptement la batterie usée. Garder hors de portée des enfants.**

#### **INDUSTRY CANADA NOTICE**

NOTICE: This equipment meets the applicable Industry Canada Terminal Equipment Technical Specifications.

The Ringer Equivalence Number (REN) for this terminal equipment is 0.2. The REN assigned to each terminal equipment provides an indication of the maximum number of terminals allowed to be connected to a telephone interface. The termination on an interface may consist of any combination of devices subject only to the requirement that the sum of the Ringer Equivalence Numbers of all the devices does not exceed five.

#### **AVIS D'INDUSTRIE CANADA**

REMARQUE: Cet équipement est conforme aux Spécifications Techniques des Équipements Terminaux d'Industrie Canada en vigueur.

Le Nombre Équivalent de Sonneries (REN) de cet équipement terminal est 0,2. Le REN attribué à chaque équipement terminal indique le nombre maximum de terminaux que l'on peut connecter à une interface téléphonique. Il est possible de raccorder à une interface plusieurs combinaisons d'appareils, mais la somme des Nombres Équivalents de Sonneries de tous ces appareils ne doit pas dépasser cinq.

# Setting Up

*Congratulations on your purchase of the Sony VAIO® computer. Sony has combined leading-edge technology in video, audio, computing, and communications to provide state-of-the-art personal computing.*

## Unpacking Your Computer

### Unpacking Your Computer

**Computer**

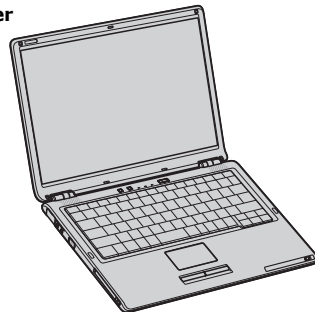

**AC adapter**

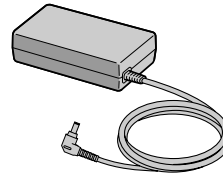

**Power cord**

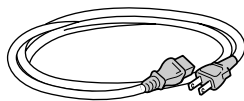

**Rechargeable battery**

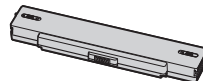

 Your VAIO® computer is not supplied with System or Application Recovery CDs. Use the VAIO Recovery Wizard utility to recover your computer's operating system and preinstalled software.

### **VAIO Computer Documents**

- ❑ **VAIO® Computer User Guide** — A searchable on-screen help file that contains detailed information on how to use your new computer. See “Locating Your VAIO Computer User Guide” on page 30 for more information.
- ❑ **VAIO® Computer Quick Start** (this document) — Contains information on unpacking and setting up your computer for immediate use.
- ❑ **VAIO® Computer Specifications** — An online file that details the hardware specifications and lists the installed programs on your computer. Go to <http://www.sony.com/pcsupport> for more information.
- ❑ **VAIO® Recovery Options Manual** — Provides information about restoring individual software programs, software drivers, drive partition(s), or your entire hard disk drive to the original factory installed settings.

### **Software CDs**

Depending on the model you purchased, additional program CDs may be included with your computer.

### **Hard Disk Drive Recovery**

Your computer is equipped with the VAIO Recovery Wizard utility program that recovers your computer’s operating system and preinstalled software. For more information about hard disk drive recovery, do the following:

- 1 Click **Start** in the Windows® taskbar, then click **Help and Support**.
- 2 From the **VAIO Help and Support Center**, click **VAIO Recovery Options**.



You can create a VAIO Recovery Media Kit using CD-R, single-layer DVD+R, or single layer DVD-R media on VAIO computers equipped with the appropriate optical disc drive.

DVD+RW, DVD-RW, double layer DVD+R, and double layer DVD-R media cannot be used to create a VAIO Recovery Media Kit.

## Locating Controls and Ports

### Front

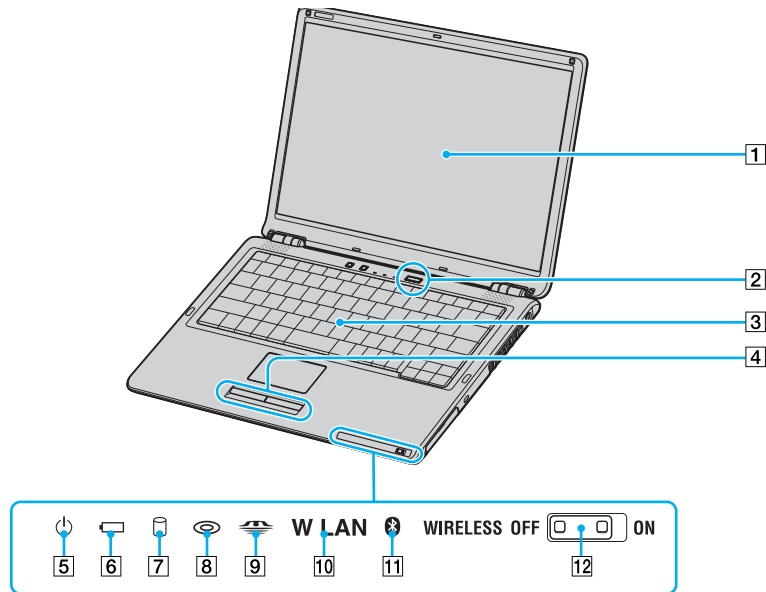

<b>1</b>	Computer screen (LCD)	<b>7</b>	Hard disk drive indicator
<b>2</b>	Power button	<b>8</b>	Optical drive indicator
<b>3</b>	Keyboard	<b>9</b>	Memory Stick® media indicator
<b>4</b>	Left and right buttons	<b>10</b>	Wireless LAN indicator*
<b>5</b>	Power indicator	<b>11</b>	Bluetooth® indicator*
<b>6</b>	Battery indicator	<b>12</b>	Wireless switch*

\* Wireless LAN and Bluetooth capabilities are available on selected models only.

**Front**

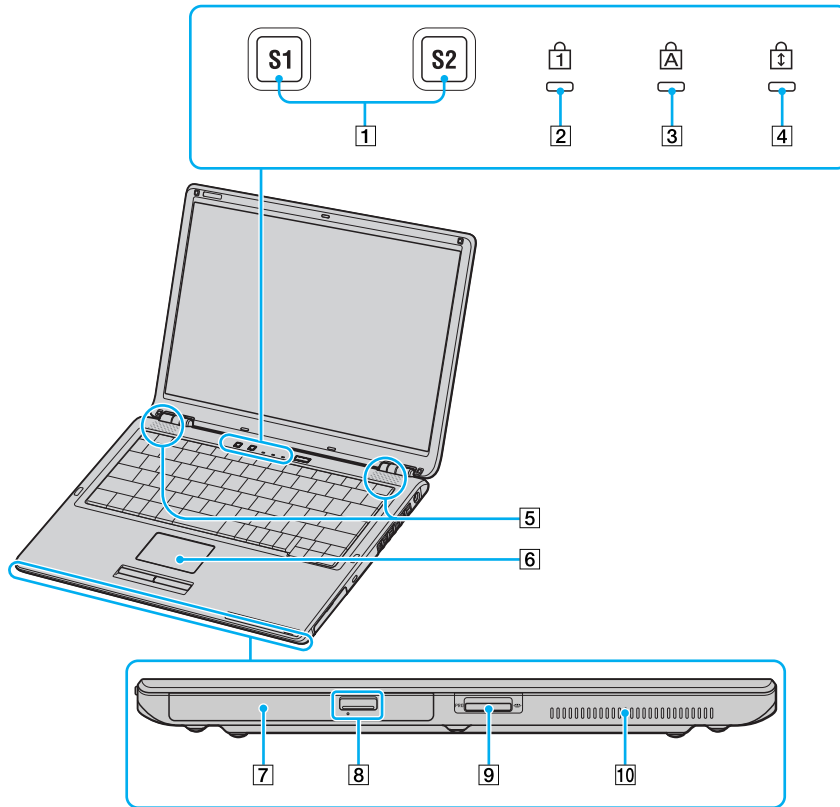

<b>1</b>	S1 and S2 programmable buttons	<b>6</b>	Touch pad
<b>2</b>	Num lock indicator	<b>7</b>	Optical drive
<b>3</b>	Caps lock indicator	<b>8</b>	Optical drive eject button and manual eject hole
<b>4</b>	Scroll lock indicator	<b>9</b>	Memory Stick® media slot
<b>5</b>	Speakers	<b>10</b>	Air vent



*Left*

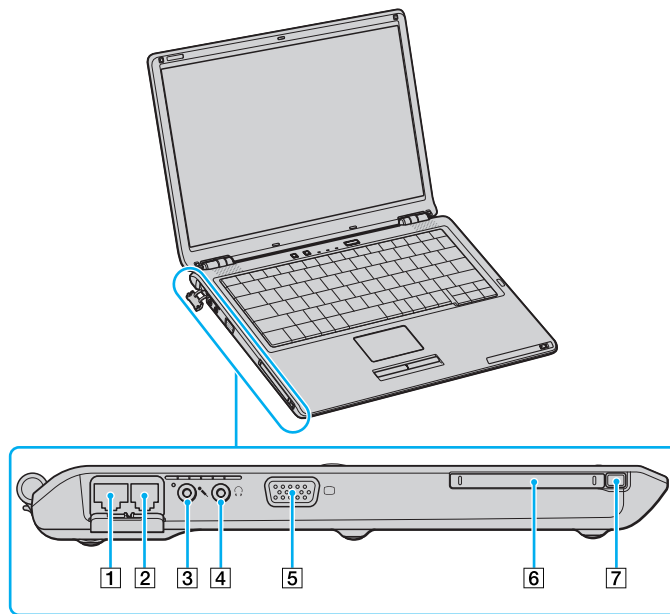

1	Network (Ethernet) port	5	Monitor (VGA) port
2	Modem jack	6	PC Card slot
3	Microphone jack	7	PC Card eject button
4	Headphone jack		

 Gently pull the protective tab away from the computer to find the Network (Ethernet) port and Modem jack. Do not remove the tab.



**Only connect 10BASE-T or 100BASE-TX cables to the  Network (Ethernet) port. Do not connect any other type of network cable or any telephone line to this port. Connecting cables other than those listed above may result in an electric current overload and could cause a malfunction, excessive heat, or fire in the port. To connect the unit to a network, refer to your on-screen VAIO® Computer User Guide or contact your network administrator. See “Locating Your VAIO Computer User Guide” on page 30 for more information.**

**Right**

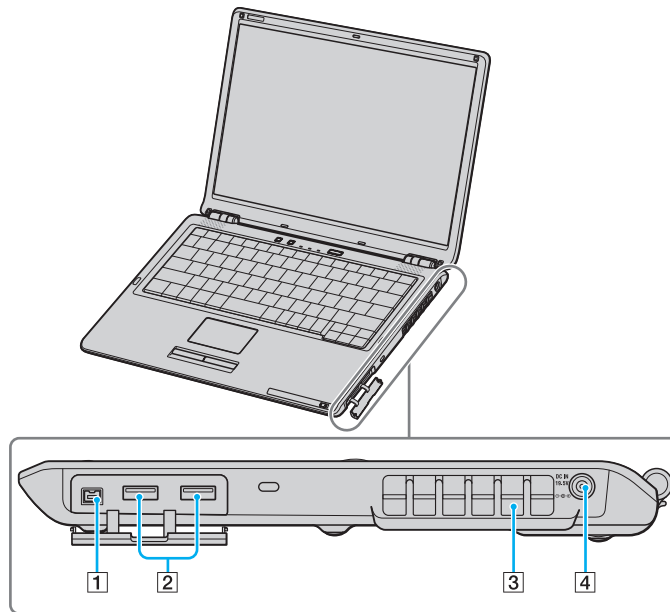

- |          |                               |          |            |
|----------|-------------------------------|----------|------------|
| <b>1</b> | i.LINK® (IEEE 1394) S400 port | <b>3</b> | Air vent   |
| <b>2</b> | USB 2.0 ports*                | <b>4</b> | DC IN port |

\* Supports high-/full-/low- speeds.

 Gently pull the protective tab away from the computer to find the i.LINK S400 and USB 2.0 ports. Do not remove the tab.

**Back\***

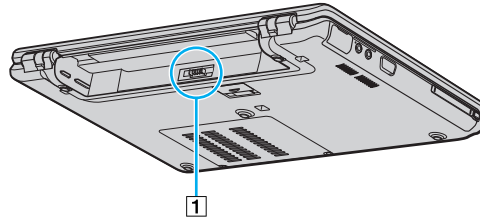

\* The bottom panel illustration may vary slightly from the actual computer.

---

**1** Battery connector

---

**Bottom**

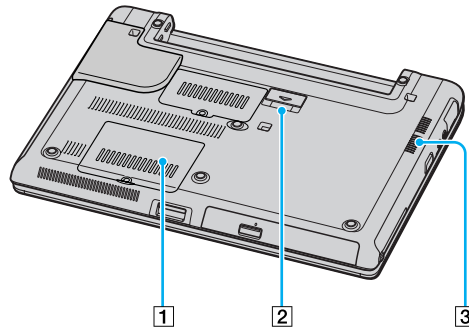

---

**1** Memory bay cover

**3** Air vent

---

**2** Port replicator connector

---

Your computer may also come with the optional port replicator, depending on the model that you purchased.

 The printer port on this port replicator is intended for printer connections only.

**Port Replicator\* (Back Panel)**

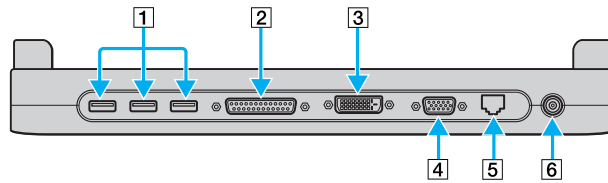

\* Optional with selected models only.







---

<b>1</b> USB ports*	<b>4</b> Monitor (VGA) port
<b>2</b> Printer port	<b>5</b> Network (Ethernet) port (10BASE-T/100BASE-TX)
<b>3</b> DVI-D port	<b>6</b> DC IN port

---

\* Supports high-/full-/low- speeds.

## About the Indicator Lights

<i>Indicator</i>	<i>Function</i>
Power 	Turns on when the power to the computer is on, blinks in Standby mode, and turns off when the computer is in Hibernate mode or off.
Battery 	Turns on when the computer is using battery power, blinks when the battery is running out of power, double-blinks when the battery is charging.
Optical Drive 	Turns on when data is read from or written to the optical drive. Do not enter Standby mode or turn off the computer when this indicator is on.
Memory Stick® 	Turns on when data is read from or written to the Memory Stick media. (Do not enter Standby mode or turn off the computer when this indicator is on.) When the indicator is off, the Memory Stick media is not being used.
Hard Disk 	Turns on when data is read from or written to the hard disk. Do not enter Standby mode or turn off the computer when this indicator is on.
Num Lock 	Press the Num Lock key to activate the numeric keypad. The Num Lock indicator is on only while the numeric keypad is active. Pressing the Num Lock key a second time deactivates the numeric keypad.
Caps Lock 	Press the Caps Lock key to activate the Caps Lock indicator. Letters appear in uppercase only while the indicator is on. If you press Shift while the indicator is on, letters appear in lowercase. Pressing the Caps Lock key a second time turns off the indicator.

<b>Indicator</b>	<b>Function</b>
Scroll Lock 	Press the Scroll Lock key to activate the Scroll Lock indicator. The Scroll Lock feature changes how you scroll the display. It may function differently depending on the program you are using and does not work with all programs. Normal scrolling resumes when the Scroll Lock indicator is off.
Bluetooth®*	Turns on when the wireless switch is set to ON and Bluetooth technology is enabled.
Wireless LAN*	Turns on when the wireless LAN function is running.

\* On selected models only.

# Getting Started

*This section helps you get your computer running and registered, so you can take advantage of Sony's many support options. You'll also learn how to locate your on-screen VAIO® Computer User Guide, which contains step-by-step instructions for operating your computer.*

## **Turning On Your Computer**

To use your computer immediately, use the supplied AC adapter as a power source. Your supplied battery is not charged when you unpack it; however, you can begin charging it when you use your AC adapter. See “Powering Your Computer” in your on-screen VAIO® Computer User Guide for more information about battery use. To find the user guide, see “Locating Your VAIO Computer User Guide” on page 30.

## **Inserting a battery**



This computer is designed to operate only with a genuine Sony battery.

### **To insert a battery**

- 1 Turn the computer over, and slide the **UNLOCK/LOCK** latch on the bottom of the battery to the **UNLOCK** position.
- 2 Align the grooves on the battery with the tabs on the back of the computer.

### *Inserting the Battery*

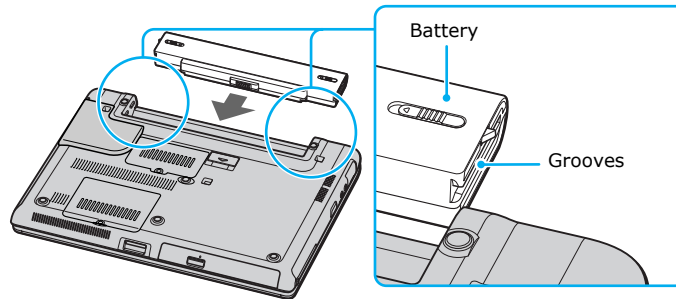

- 3 Slide the battery into the computer until it clicks into place.
- 4 Slide the **UNLOCK/LOCK** latch into the **LOCK** position.

### *Locking the Battery*

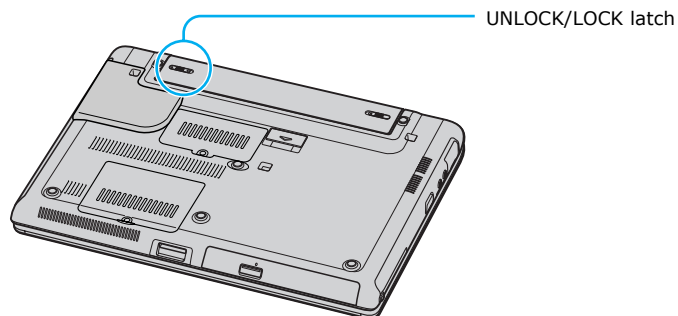

- 5 Connect the AC adapter to the computer. See “To connect the AC adapter” on page 25.

Once you connect the AC adapter to the computer, the battery begins to charge whether the computer is on or off. The battery indicator shows the battery status, and blinks as the battery charges. See “Powering Your Computer” in your on-screen VAIO® Computer User Guide for more information. To locate the user guide, see “Locating Your VAIO Computer User Guide” on page 30.



## Connecting the AC adapter

### To connect the AC adapter

- 1 Plug the AC adapter cable into the DC IN port.

### Connecting the AC Adapter to the Computer

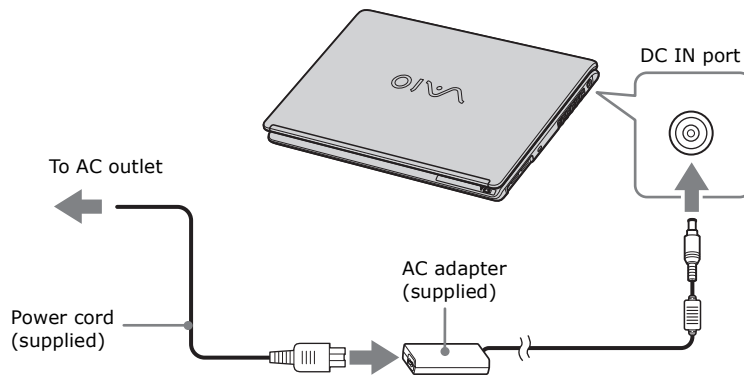

- 2 Plug the power cord into the AC adapter and an AC outlet.

 Use only the supplied AC adapter with your computer.

## Turning on the computer

### To turn on the computer

- 1 Hold the bottom of the computer firmly with one hand, and lift the LCD screen lid with the other hand.

### Opening the Computer

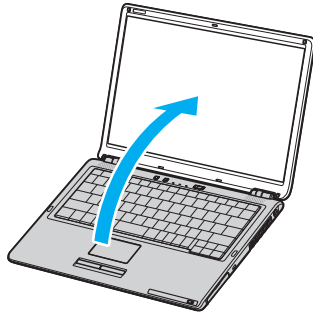

- 2 Press the power button until the power indicator turns on.

### Turning on the Computer

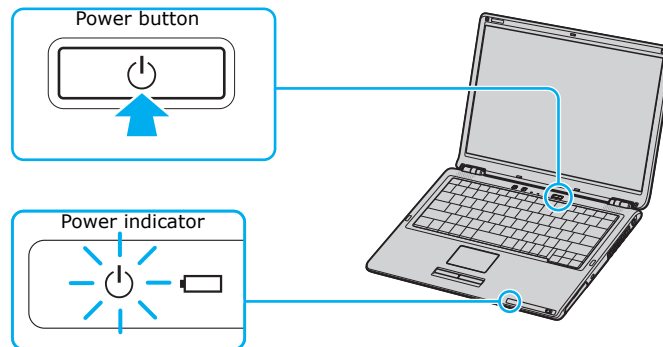

 If you press and hold the power button, the computer turns off.

- 3 Adjust the brightness of the LCD screen, if necessary.
  - Press the **Fn** and **F6** keys to increase brightness.
  - Press the **Fn** and **F5** keys to decrease brightness.

## Using the Touch Pad

The computer contains a pointing device called a touch pad. You can point to, select, drag, and scroll objects on the screen using the built-in touch pad.

### Describing the touch pad

#### Locating the Touch Pad

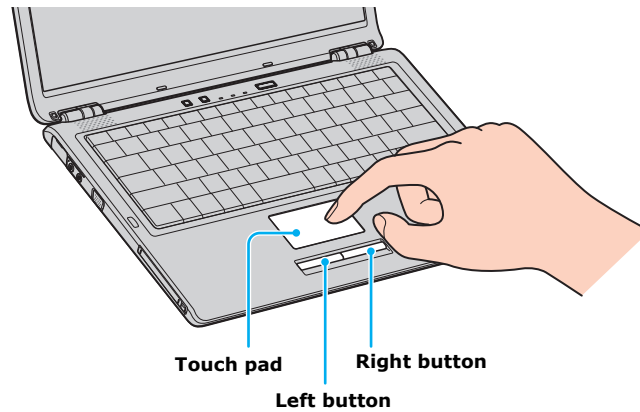

<b><i>Touch Pad Action</i></b>	<b><i>Description</i></b>
Sliding one finger	Equivalent to using a mouse to place the pointer on an item.
Tapping once	Equivalent to pressing the left button once.
Tapping twice	Equivalent to pressing the left button twice.

---

<b>Touch Pad Action</b>	<b>Description</b>
Sliding one finger while pressing the left button	Equivalent to using the mouse to drag an item.
Moving your finger along the right edge of the touch pad	Equivalent to scrolling vertically. (The scroll function is available only with programs that support a touch pad scroll feature.)
Moving your finger along the bottom to scroll horizontally	Equivalent to scrolling horizontally. (The scroll function is available only with programs that support a touch pad scroll feature.)

---

## **Registering Your Computer**

 You are prompted to register your computer the first time you turn on the unit. Follow the on-screen instructions to complete the registration process. If you are not able to register your computer during the first session, you are provided with additional registration opportunities later.

Take advantage of Sony's commitment to quality customer support and receive these benefits by registering your computer:

- Sony Customer Support — Talk to a support representative to troubleshoot problems you may have with your computer.
- Product Information Notification — By giving Sony your contact information, you will enable Sony to reach you regarding performance updates and upgrades.

## Locating Your VAIO Computer User Guide

The on-screen VAIO® Computer User Guide is a searchable help file that contains detailed information on how to use your new computer.

### To open the user guide

- 1 Click **Start** on the Windows® taskbar, and then click **Help and Support**. The **Help and Support Center** window appears, displaying information about your VAIO® computer and Microsoft® Windows® operating system.

### Locating the VAIO User Guide (Windows XP)

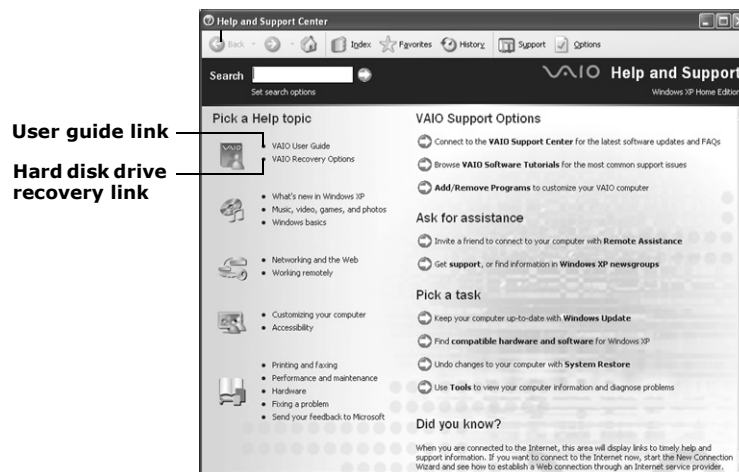

- 2 Under **Pick a Help topic**, click **VAIO User Guide**. The user guide appears.

**VAIO® User Guide**

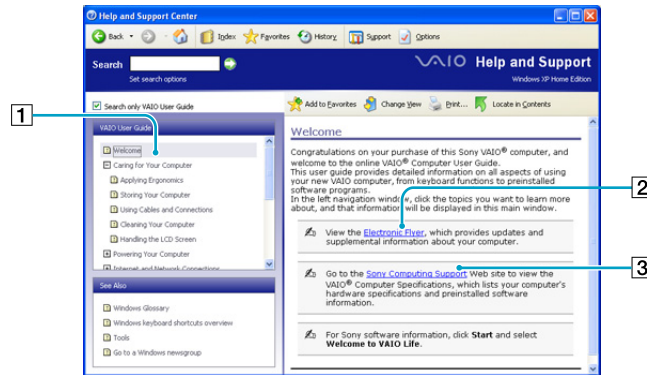

---

<b>1</b>	User guide table of contents	List of computer help topics
<b>2</b>	Link to Electronic Flyer	List of updates and supplemental information about your computer
<b>3</b>	Link to Sony Online Support Web site	Includes support information and list of your computer's hardware specifications (Internet access required).

---

## Setting Up A Dial-Up Connection

This section describes the basic steps for setting up your dial-up connection. The Connection Wizard guides you through the process of choosing an Internet Service Provider (ISP) or setting up an existing account, and connecting to the Internet.

### To connect a telephone cable

- 1 Gently peel back the protective cover of the Modem jack and Ethernet port, located on the left side of the computer. Make sure not to tear the cover off.

### Connecting a Telephone Cable

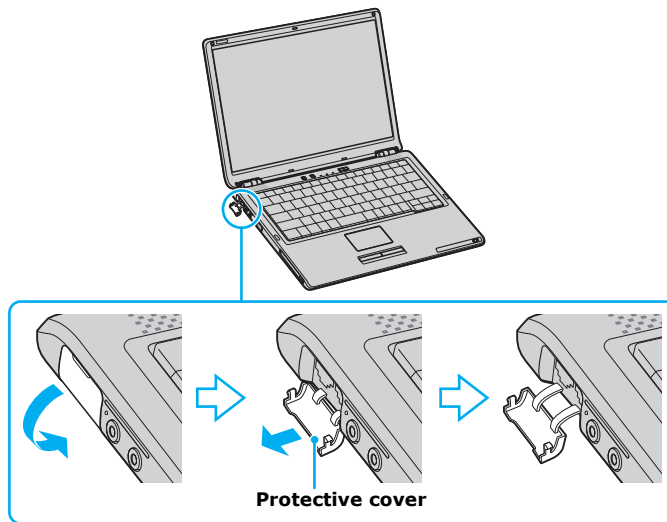

- 2 Plug one end of the telephone cable into the Modem jack. Make sure it clicks into place.
- 3 Plug the other end into the wall jack.



**Connecting a Telephone Cable**

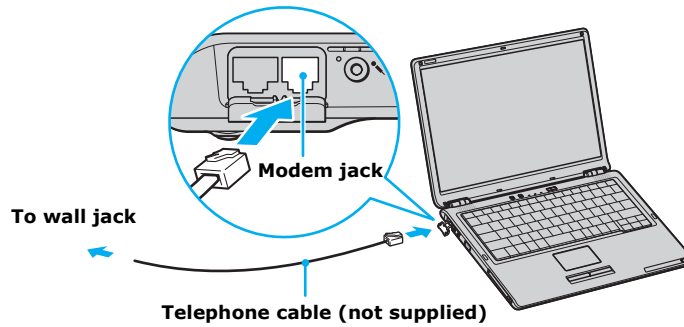

 Your computer does not work with party lines, cannot be connected to a coin-operated telephone, and may not work with multiple telephone lines or a private branch exchange (PBX). Some of these connections may result in excess electrical current and could cause a malfunction in the internal modem.

If you connect a telephone cable coming through a splitter, the modem or connected device may not work properly.

***To set up a dial-up connection***

- 1 Click **Start**, point to **All Programs, Accessories, Communications**, and then click **New Connection Wizard**. The **New Connection Wizard** appears.

***New Connection Wizard***



- 2 Click **Next**.
- 3 If it is not already selected, click **Connect to the Internet**.
- 4 Click **Next**.
- 5 Follow the on-screen instructions.

## Turning Off Your Computer

Using the power button to turn off your computer may result in loss of data. Follow the steps below to properly turn off your computer and avoid losing data.

### To turn off your computer

- 1 Close all operations.
- 2 Click **Start** on the Windows® taskbar.
- 3 Click **Turn Off Computer** at the bottom of the **Start** menu to display the **Turn off computer** window, and select **Turn Off**.

 Respond to any prompts warning you to save documents.

- 4 Wait for your computer to turn off automatically. The computer is off when the power indicator turns off.

 During a period of inactivity, you can conserve battery life by using power saving modes. See the on-screen VAIO® Computer User Guide for more information.

 If you are unable to turn off the computer, press and hold the power button until the computer turns off. This operation may result in data loss.



# Troubleshooting

## **What do I do if my computer won't start?**

- ❑ Make sure the computer is securely plugged into a power source and turned on. Make sure the power indicator shows the power is on.
- ❑ Make sure the battery is inserted properly and charged.
- ❑ Make sure the floppy disk drive (if applicable) is empty.
- ❑ If the computer is plugged into a power strip or uninterruptible power supply (UPS), make sure the power strip or UPS is turned on and working.
- ❑ If you are using an external display, make sure it is plugged into a power source and turned on. Make sure the brightness and contrast controls are adjusted correctly. See the guide that came with your display for details.
- ❑ Disconnect the AC adapter and remove the battery. Wait one minute. Reattach the AC adapter and reinsert the battery. Turn on the power.
- ❑ Condensation may cause the computer to malfunction. If this occurs, do not use the computer for at least one hour.
- ❑ If the computer still does not turn on, follow these steps:
  - 1 Unplug the power cord and remove the battery.
  - 2 Reinsert the power cord and the battery.
  - 3 Turn on the computer.

 For further instructions, contact Sony Computing Support (<http://www.sony.com/pcsupport>).

## **What do I do if a BIOS error appears when my computer starts?**

If the message “Press <F1> to resume, <F2> to setup” appears at the bottom of the screen, follow these steps:

- 1 Press the **F2** key. The **BIOS Setup** menu appears.
- 2 Set the date (month/day/year). Press **Enter**.
- 3 Press the **Down Arrow** key **↓** to select **System Time**, and then set the time (hour: minute: second). Press **Enter**.
- 4 Press the **Right Arrow** key **→** to select the **Exit** tab, and then press the **Down Arrow** key **↓** to select **Get Default Values**. The message **Load default values for all SETUP items** appears.
- 5 Press the **Enter** key. The **Setup Confirmation** window appears.
- 6 Select **Yes**, and press **Enter**.
- 7 Select **Exit (Save Changes)**, and press **Enter**. The **Setup Confirmation** window appears.
- 8 Select **Yes**, and press **Enter**. The computer restarts.



If this occurs on a regular basis, contact Sony Computing Support (<http://www.sony.com/pcsupport>).

***What do I do if the message “Operating system not found” appears when my computer starts, and why won’t Windows start?***

- Make sure the computer does not have a “non-bootable” floppy disk in the floppy disk drive (if applicable).
- If a non-bootable floppy disk is in the drive:
  - 1 Remove the floppy disk.
  - 2 Restart the computer and confirm that the Microsoft® Windows® operating system starts properly.
- If the Windows operating system still does not start, follow these steps to initialize the BIOS:
  - 1 Turn off the computer.
  - 2 Remove any peripheral devices connected to the computer.
  - 3 Restart the computer.

- 4 Press the **F2** key when the VAIO logo appears. The **BIOS Setup** window appears.
- 5 Press the **Right Arrow** key **→** to select the **Exit** menu.
- 6 Press the **Down Arrow** key **↓** to select **Get Default Values**. The message **Load default values for all SETUP items**. appears.
- 7 Press the **Enter** key. The **Setup Confirmation** window appears.
- 8 Select **Yes**, and press **Enter**.
- 9 Select **Exit (Save Changes)**, and press **Enter**. The **Setup Confirmation** window appears.
- 10 Select **Yes**, and press **Enter**. The computer restarts.

### ***What do I do if my computer stops responding?***

It is best to turn off your computer using the Turn Off Computer option on the Microsoft® Windows® Start menu, located on the taskbar. Using other methods, including those listed below, may result in loss of unsaved data.

- Click **Start** on the Windows® taskbar, select **Turn Off Computer**, and then click **Turn Off**.
- If your computer does not turn off, press the **Ctrl+Alt+Delete** keys simultaneously. When the **Windows Task Manager** dialog box appears, click **Turn Off** from the **Shut Down** menu.
- If your computer still does not turn off, press and hold the power button until the computer turns off.
- If your computer stops responding while playing a CD or DVD, press the **Ctrl+Alt+Delete** keys simultaneously. You can turn off the computer from the **Windows Task Manager**.

 Pressing the **Ctrl+Alt+Delete** keys simultaneously or turning off the computer with the power button may cause loss of data.

- Remove the AC adapter and battery.

## **Support Options**

If you have questions about your computer or the preinstalled programs, refer to the following sources for answers in the sequence listed below.

- 
- 1 VAIO® Computer Documentation**

The on-screen VAIO® Computer User Guide and this VAIO Computer Quick Start provide detailed information on how to maximize your computer's capabilities and solve common problems.

---

  - 2 Program Guides and Help Files**

The preinstalled programs on your computer may come with individual help guides. These guides are stored on the hard disk as on-screen Help files. You can find the Help files from the Help menu under the specific program.

---

  - 3 Operating System Online Support**

Your computer comes preinstalled with a Microsoft® Windows® operating system. For operating system support, you can visit Microsoft® customer support at: <http://support.microsoft.com/directory/>.

---

  - 4 Sony Computing Support**

This service provides instant access to information on commonly encountered problems. Type a description of the problem and the Knowledge Database searches for the corresponding solutions online. You can visit Sony Computing Support at: <http://www.sony.com/pcsupport>.

---

  - 5 VAIO Update**

When your computer is connected to the Internet, VAIO Update automatically notifies you when critical software and security information is posted on the support Web site. Click the VAIO Update notice to open the VAIO Support Web site and view the information. You can also right-click the **VAIO Update** icon  in the **Taskbar Notification** area and select **Go to VAIO Web Support** to open the support Web site.
-









For customer support information, go to:  
<http://www.sony.com/pcsupport>

VAIO Homepage  
<http://www.vaio.net>  
© 2005 Sony Electronics Inc.  
Printed in USA  
2-585-813-01

