SONY

3-798-139-22(1)

WALKMAN

Radio Cassette Player

WM-FX433/FX435

Operating Instructions

WALKMAN is a registered trademark of Sony Corporation.

Sony Corporation © 1995

Printed in Malaysia

OWNER'S RECORD

The model number is located at the rear and the serial number is located inside the cassette holder. Record these numbers in the spaces provided below. Refer to them whenever you call upon your Sony dealer regarding this product.

Model No. _____

Serial No. _____

INFORMATION

This equipment has been tested and found to comply with the limits for a Class B digital device, pursuant to Part 15 of the FCC Rules. These limits are designed to provide reasonable protection against harmful interference in a residential installation. This equipment generates, uses, and can radiate radio frequency energy and, if not installed and used in accordance with the instructions, may cause harmful interference to radio communications. However, there is no guarantee that interference will not occur in a particular installation. If this equipment does cause harmful interference to radio or television reception, which can be determined by turning the equipment off and on, the user is encouraged to try to correct the interference by one or more of the following measures:

- Reorient or relocate the receiving antenna.
- Increase the separation between the equipment and receiver.
- Connect the equipment into an outlet on a circuit different from that to which the receiver is connected.
- Consult the dealer or an experienced radio/TV technician for help.

This device complies with Part 15 of the FCC Rules. Operation is subject to the following two conditions:

- (1) This device may not cause harmful interference, and
- (2) this device must accept any interference received, including interference that may cause undesired operation.

You are cautioned that any changes or modifications not expressly approved in this manual could void your authority to operate this equipment.

SONY

Tape Cassette Player/Recorder/CD Player/Mini Disc
DAT /Radio/Head Phone/Speaker/MIC/Personals

Portable Audio

LIMITED WARRANTY

SONY ELECTRONICS INC. ("SONY") warrants this Product (including any accessories) against defects in material or workmanship as follows.

1. **LABOR:** For a period of 90 days from the date of purchase, if this Product is determined to be defective, Sony will repair the Product at no charge, or pay the labor charges to any SONY authorized service facility. After the Warranty Period, you must pay for all labor charges.

2. **PARTS:** In addition, SONY will supply, at no charge, new or rebuilt replacements in exchange for defective parts for a period of one (1) year. After 90 days from the date of purchase, labor for removal and installation is available from SONY authorized service facilities or a Sony Service Center at your expense.

To obtain warranty service, you must take the Product, or deliver the Product freight prepaid, in either its original packaging or packaging affording an equal degree of protection, to any authorized SONY service facility.

This warranty does not cover customer instruction, installation, set up adjustments or signal reception problems.

This warranty does not cover cosmetic damage or damage due to acts of God, accident, misuse, abuse, negligence, commercial use, or modification of, or to any part of the Product, including the antenna. This warranty does not cover damage due to improper operation or maintenance, connection to improper voltage supply, or attempted repair by anyone other than a facility authorized by Sony to service the Product. This warranty does not cover Products sold AS IS or WITH ALL FAULTS, or consumables (such as fuses or batteries). This warranty is valid only in the United States.

Proof of purchase in the form of a bill of sale or receipted invoice which is evidence that the unit is within the Warranty period must be presented to obtain warranty service.

This warranty is invalid if the factory applied serial number has been altered or removed from the Product.

REPAIR OR REPLACEMENT AS PROVIDED UNDER THIS WARRANTY IS THE EXCLUSIVE REMEDY OF THE CONSUMER. SONY SHALL NOT BE LIABLE FOR ANY INCIDENTAL OR CONSEQUENTIAL DAMAGES FOR BREACH OF ANY EXPRESS OR IMPLIED WARRANTY ON THIS PRODUCT. EXCEPT TO THE EXTENT PROHIBITED BY APPLICABLE LAW, ANY IMPLIED WARRANTY OF MERCHANTABILITY OR FITNESS FOR A PARTICULAR PURPOSE ON THIS PRODUCT IS LIMITED IN DURATION TO THE DURATION OF THIS WARRANTY.

Some states do not allow the exclusion or limitation of incidental or consequential damages, or allow limitations on how long an implied warranty lasts, so the above limitations or exclusions may not apply to you. In addition, if you enter into a service contract with the Sony Partnership within 90 days of the date of sale, the limitation on how long an implied warranty lasts does not apply to you. This warranty gives you specific legal rights, and you may have other rights which vary from state to state.

For your convenience, SONY ELECTRONICS INC. has established telephone numbers for frequently asked questions:

To locate the service or dealer nearest you, call:

1-(800)-342-5721

For service assistance or resolution of a service problem, call:

SONY CUSTOMER RELATIONS CENTER
1-(800)-282-2848

For Product information or operation, call:

SONY CUSTOMER INFORMATION CENTER
(201)-368-9272

or write to:
Sony Customer Information Center
One Sony Drive
Park Ridge, New Jersey 07656-8003

For an accessory or part not available from your authorized dealer, call:

1-(800)-488-SONY (7669)

Using the Belt Clip

With the supplied belt clip, you can wear your Walkman on a belt for convenient use.

Attaching the Belt Clip

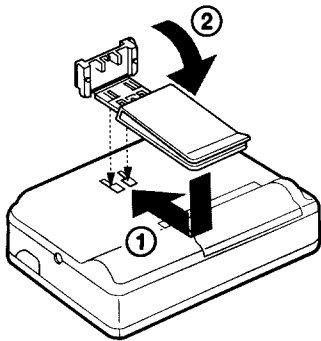

To remove the belt clip, complete in the reverse order.

Specifications

Radio Frequency (For U area indication)

FM: 87.5 - 108 MHz (0.1 MHz step)
AM: 530 - 1,710 kHz (10 kHz step)
TV: 2 - 13 channel

Power Requirements

3 V DC Batteries AA (R6) × 2
External DC 3 V power sources

Battery Life

(approximate hours when using the batteries specified below)

Battery	Playback	Radio
Sony Alkaline AM3 (N)	18 hours	25 hours
Sony SUM-3 (NS)	8.5 hours	12 hours

Dimensions

112.8 × 86.6 × 32.7 mm (4½ × 3½ × 1¼ in.) (w/h/d)
incl. projecting parts

Mass

210 g (7.5 oz) incl. batteries

Supplied Accessories

- Stereo headphones (1)
- Belt clip (1)

Optional Accessories

- AC power adaptor AC-E30HG
- Car battery cord DCC-E130L

Your dealer may not handle some of the optional accessories listed above. Please ask the dealer for detailed information.

Design and specifications are subject to change without notice.

Dolby noise reduction manufactured under license from Dolby Laboratories Licensing Corporation.
"DOLBY" and the double-D symbol  are trademarks of Dolby Laboratories Licensing Corporation.

Precautions

Notes on headphones

Concerning Road Safety

Do not use headphones while driving, cycling, or operating any motorized vehicle. It may create a traffic hazard and is illegal in many areas. It can also be potentially dangerous to play your headsets at high volume while walking, especially at pedestrian crossings. You should exercise extreme caution or discontinue use in potentially hazardous situations.

Preventing hearing damage

Do not use headphones at high volume. Hearing experts advise against continuous, loud and extended play. If you experience a ringing in your ears, reduce volume or discontinue use.

Caring for others

Keep the volume at a moderate level. This will allow you to hear outside sounds and to be considerate to the people around you.

Taking Care of Your Walkman

- Do not expose the Walkman to extreme temperatures, direct sunlight, moisture, sand, dust or mechanical shock. Never leave the Walkman in a car parked in the sun.
- Do not wind the headphones cord around the Walkman.
- The buttons may be kept pressed, causing unnecessary battery usage.
- Prolonged use may contaminate the tape head. If sound drop-out or excessive noise occurs, clean the head and tape path with alcohol.

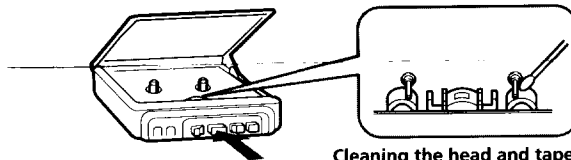

Cleaning the head and tape path

- Clean the headphones plug periodically for optimum sound.
- Do not use alcohol, benzine or thinner to clean the case.

About the Battery Compartment Lid

If the battery compartment lid is detached by an accidental drop, excessive force etc., attach it as illustrated in the numbered order.

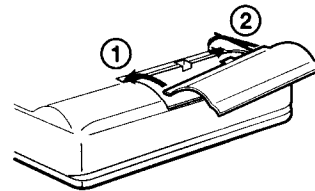

If you have any question or problem concerning your Walkman, please consult your nearest Sony dealer.

Notes

- If you keep pressing the TUNING + or - button, the frequency digits go up or down quickly. And when you release, the frequency digits go up or down step by step. When the desired station is heard, press the TUNING + or - button again to stop the tuning.
- The STEREO indication comes on in the display when receiving an FM stereo broadcast.
- TV channel range is 2 to 13.
- If you press the ◀ PLAY, ◀◀ or ▶▶ button while listening to the radio, the tape operation begins.
- If you have inserted a cassette with a metallic shell or label, and interference in radio reception occurs, remove the cassette.

Presetting Stations

You can preset up to 15 radio stations, 5 for each FM, TV and AM bands.

- 1 Press the RADIO ON/OFF button.**



- 2 Tune in the desired station by using the BAND and TUNING +/- buttons.**

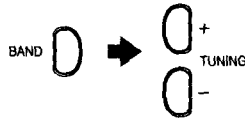

- 3 Press the ENTER button to enter the presetting mode.**



The PRESET indication comes on and starts flashing.

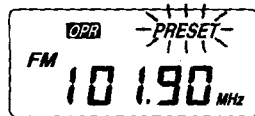

- 4 Press one of the PRESET buttons 1 to 5 within six seconds of flashing.**



The PRESET indication and the preset number flash.

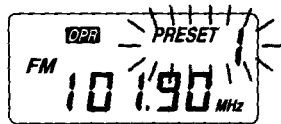

- 5 Press the ENTER button within six seconds of flashing.**



The PRESET indication and the preset number light.

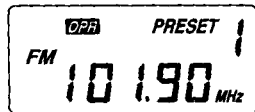

To recall the preset station

Press the BAND button to select the band, and then press the corresponding preset button.

Improving Radio Reception

Improving FM reception

Extend the headphones cord or adjust the DX/LOCAL switch.

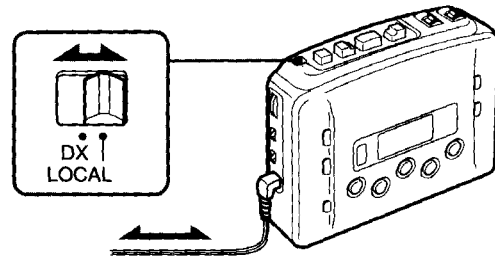

Improving AM reception

Rotate the Walkman.

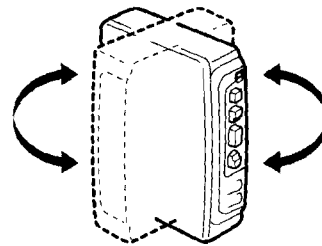

Listening to the Radio Abroad

The frequency range differs depending on the area. If you listen to the radio in an area of different frequency range, change the area indication in the display. To change it, press the ENTER button while the radio is turned on. Press and hold the BAND button until the area indication flashes. Then, press the BAND button again to change the area indications ("U": USA and Canada; "E": European and other countries). Press the ENTER button to set the frequency range.

Notes

- If you change the frequency range, all the preset stations in the memory will be canceled.
- For E area indication, the hour display is on a 24-hour cycle.

Setting the Clock

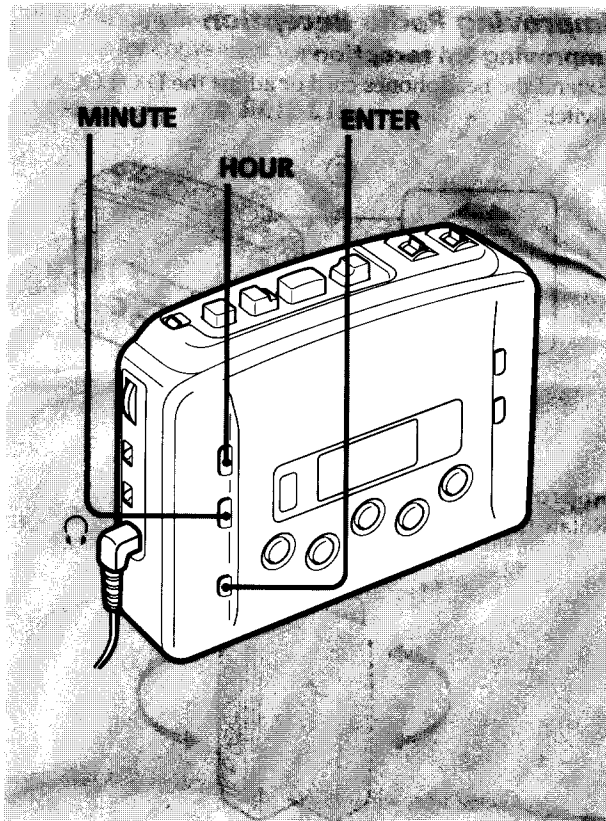

- 1** Press the **ENTER** button to enter the current time setting mode.



- 2** Set the time by using the **HOUR**/**MINUTE** buttons within six seconds of flashing.

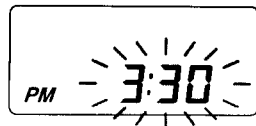
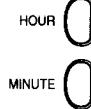

- 3** Press the **ENTER** button to return to the current time display.

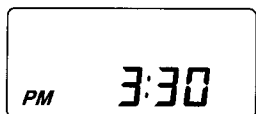

Playing Cassette

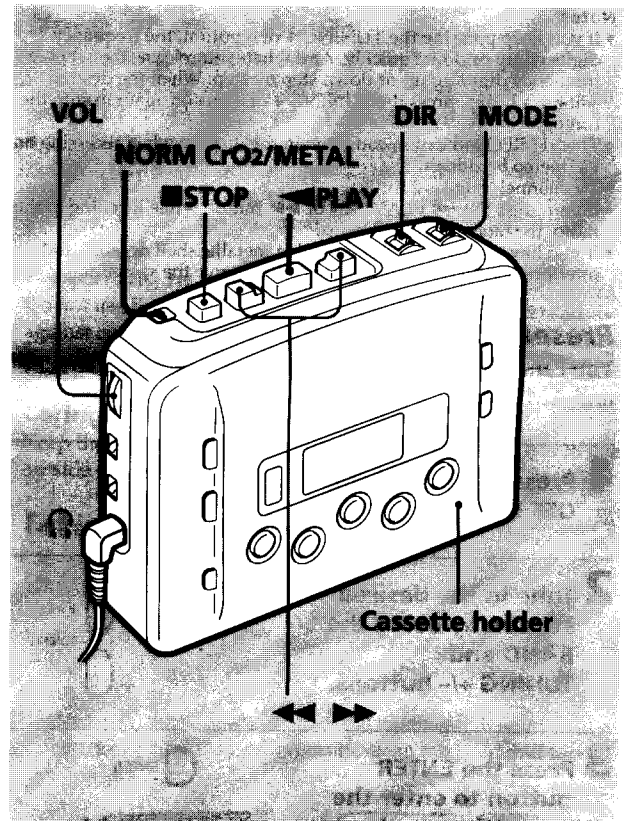

- 1** Insert a cassette.

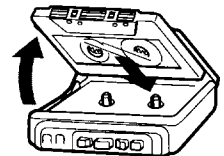

- 2** Select the **NORM** or **CrO₂/METAL** mode to match the tape type.

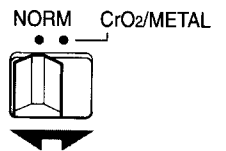

- 3** Press the **PLAY** button.



Note
When the tape is played or the radio is turned on, the OPR indication comes on in the display.

Listening to the Radio

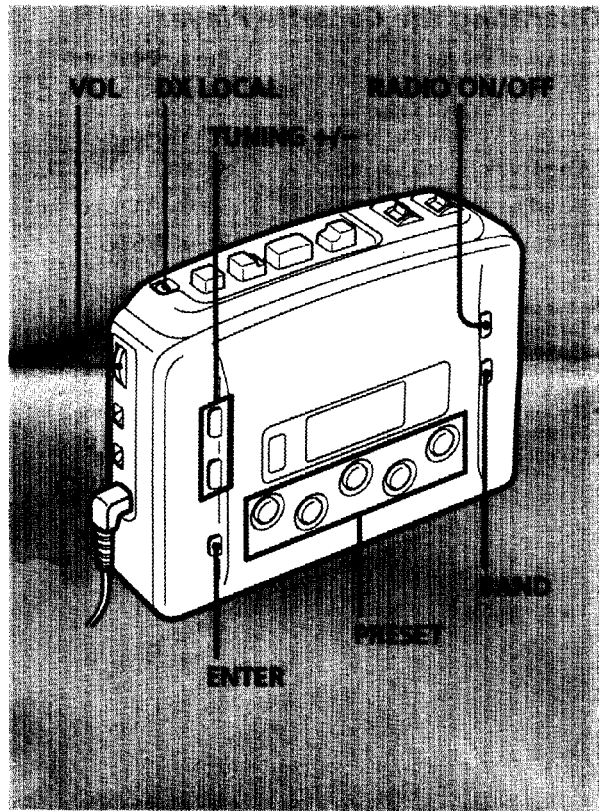

- 1** Press the **RADIO ON/OFF** button.



- 2** Press the **BAND** button to select the band (FM, TV or AM).

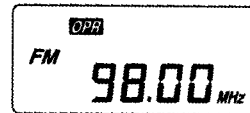

- 3** Press the **TUNING +/-** buttons to tune in the desired station.

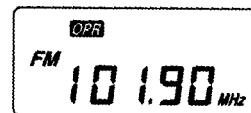
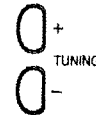

To adjust the volume	Set the VOL control.
To turn off	Press RADIO ON/OFF.