

FM/AM Cassette Car Stereo

Operating Instructions _____

US

Owner's Record

The model and serial numbers are located on the bottom of the unit.

Record the serial number in the space provided below.

Refer to these numbers whenever you call upon your Sony dealer regarding this product.

Model No. XR-C5300X/C5305 Serial No. _____

For installation and connections, see the supplied installation/connections manual.

XR-C5300X
XR-C5305

Warning

This equipment has been tested and found to comply with the limits for a Class B digital device, pursuant to Part 15 of the FCC Rules. These limits are designed to provide reasonable protection against harmful interference in a residential installation. This equipment generates, uses, and can radiate radio frequency energy and, if not installed and used in accordance with the instructions, may cause harmful interference to radio communications. However, there is no guarantee that interference will not occur in a particular installation. If this equipment does cause harmful interference to radio or television reception, which can be determined by turning the equipment off and on, the user is encouraged to try to correct the interference by one or more of the following measures:

- Reorient or relocate the receiving antenna.
- Increase the separation between the equipment and receiver.
- Connect the equipment into an outlet on a circuit different from that to which the receiver is connected.
- Consult the dealer or an experienced radio/TV technician for help.

You are cautioned that any changes or modifications not expressly approved in this manual could void your authority to operate this equipment.

Welcome !

Thank you for purchasing this Sony Cassette Player. This unit lets you enjoy a variety of features using the following controller accessory:

Optional accessory

- Rotary commander RM-X4S
- Card remote commander RM-X91

In addition to the cassette playback and radio operations, you can expand your system by connecting an optional CD/MD unit*¹. When you operate this unit or a connected optional CD unit with the CD TEXT function, the CD TEXT information will appear in the display when you play a CD TEXT disc*².

*¹ You can connect a CD changer, an MD changer, a CD player, or an MD player.

*² A CD TEXT disc is an audio CD that includes information such as the disc name, artist name, and track names.
This information is recorded on the disc.

Precautions

- If your car was parked in direct sunlight resulting in a considerable rise in temperature inside the car, allow the unit to cool off before operating it.
- If no power is being supplied to the unit, check the connections first. If everything is in order, check the fuse.
- If no sound comes from the speakers of a two-speaker system, set the fader control to the center position.
- When a tape is played back for a long period, the cassette may become warm because of the built-in power amplifier. However, this is not a sign of malfunction.

If you have any questions or problems concerning your unit that are not covered in this manual, please consult your nearest Sony dealer.

To maintain high quality sound

If you have drink holders near your audio equipment, be careful not to splash juice or other soft drinks onto the car audio. Sugary residues on this unit or cassette tapes may contaminate the playback heads, reduce the sound quality, or prevent sound reproduction altogether.

Cassette cleaning kits cannot remove sugar from the tape heads.



Notes on Cassettes

Cassette care

- Do not touch the tape surface of a cassette, as any dirt or dust will contaminate the heads.
- Keep cassettes away from equipment with built-in magnets such as speakers and amplifiers, as erasure or distortion on the recorded tape could occur.
- Do not expose cassettes to direct sunlight, extremely cold temperatures, or moisture.
- Slack in the tape may cause the tape to be caught in the machine. Before you insert the tape, use a pencil or similar object to turn the reel and take up any slack.

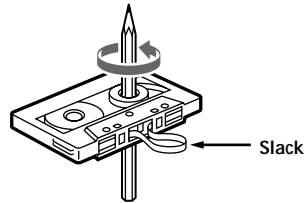

- Distorted cassettes and loose labels can cause problems when inserting or ejecting tapes. Remove or replace loose labels.



- The sound may become distorted while playing the cassette. The cassette player head should be cleaned after each 50 hours of use.

Cassettes longer than 90 minutes

The use of cassettes longer than 90 minutes is not recommended except for long continuous play. The tape used for these cassettes is very thin and tends to stretch easily. Frequent playing and stopping of these tapes may cause them to become entangled in the cassette deck mechanism.



Table of Contents

This Unit Only

Location of controls 5

Getting Started

Resetting the unit 7
Detaching the front panel 7
Turning the unit on/off 8
How to use the menu 8
Setting the clock 8

Cassette Player

Listening to a tape 9
Playing a tape in various modes 10

Radio

Memorizing stations automatically
— Best Tuning Memory (BTM) 11
Memorizing only the desired stations 11
Receiving the memorized stations 12

Other Functions

Labeling the rotary commander 13
Using the rotary commander 13
Adjusting the sound characteristics 15
Changing the sound and display settings 15
Boosting the bass sound
— D-bass 16

With Optional Equipment

CD/MD Unit

Playing a CD or MD 16
Playing tracks repeatedly
— Repeat Play 18
Playing tracks in random order
— Shuffle Play 18

TV/Video

Watching the TV 18
Watching a video 18
Memorizing TV channels automatically 19
Memorizing only the desired TV channels ... 19
Watching the TV or video while listening to a
tape, CD or MD
— Simultaneous Play 19

Additional Information

Maintenance 20
Dismounting the unit 21
Specifications 22
Troubleshooting guide 23

Location of controls

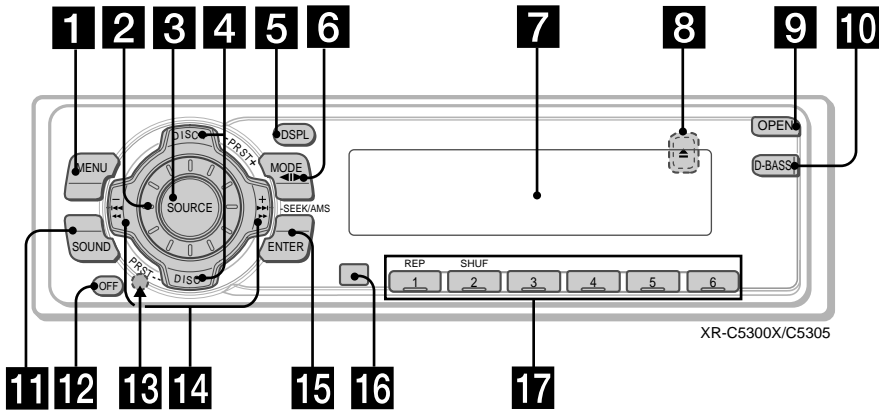

Refer to the pages listed for details.

- 1** MENU button
8, 10, 11, 12, 15, 17, 19
 - 2** Volume control dial
 - 3** SOURCE (TUNER/TAPE/CD/MD/TV) button 8, 9, 11, 12, 16, 18, 19, 20
 - 4** PRST/DISC +/- (cursor up/down) buttons 8, 10, 11, 12, 15, 17, 18, 19
During radio reception:
Preset stations select 12
During CD/MD playback:
Disc change 17
During TV reception:
Band select 18
 - 5** DSPL (display mode change) button
10, 16, 17
 - 6** MODE button 9, 11, 12, 16, 18
During tape playback:
Playback direction change 9
During radio reception:
BAND select 11
During CD/MD playback:
CD/MD unit select 16
During TV reception:
Unit select 18
 - 7** Display window
 - 8** ▲ (eject) button (located on the front side of the unit behind the front panel) 9, 20
 - 9** OPEN button 7, 9, 21
 - 10** D-BASS button 16
 - 11** SOUND button 15
 - 12** OFF button* 7, 8, 9
 - 13** Reset button (located on the front side of the unit behind the front panel) 7
 - 14** SEEK/AMS +/- (cursor left/right) buttons 8, 9, 10, 11, 12, 15, 17, 19, 20
Seek 11
Automatic Music Sensor 9, 17
Manual search 12, 17
 - 15** ENTER button
8, 10, 11, 12, 15, 17, 19, 20
 - 16** Receptor for the card remote commander
 - 17** Number buttons
During tape playback:
① REP 10
During radio reception
Preset number select 11, 12
During CD/MD playback:
① REP 18
② SHUF 18
During TV reception:
Preset number select 19
- * **Warning when installing in a car without ACC (accessory) position on the ignition key switch**
Be sure to press **OFF** on the unit for two seconds to turn off the clock display after turning off the engine.
When you press **OFF** only momentarily, the clock display does not turn off and this causes battery wear.

Optional
Card remote commander RM-X91

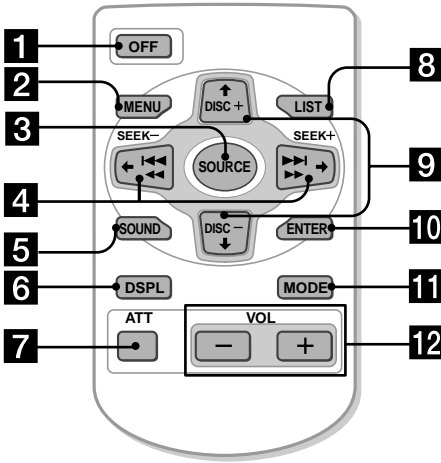

The corresponding buttons of the card remote commander control the same functions as those on this unit.

- 1 OFF button
- 2 MENU button
- 3 SOURCE button
- 4 SEEK/AMS (cursor \leftarrow/\rightarrow) button
- 5 SOUND button
- 6 DSPL button
- 7 ATT button
- 8 LIST button (Not available for this model)
- 9 DISC (cursor \uparrow/\downarrow) button
- 10 ENTER button
- 11 MODE button
- 12 VOL button

Replacing the lithium battery

When the battery becomes weak, the range of the card remote commander becomes shorter. Replace the battery with a new CR2025 lithium battery.

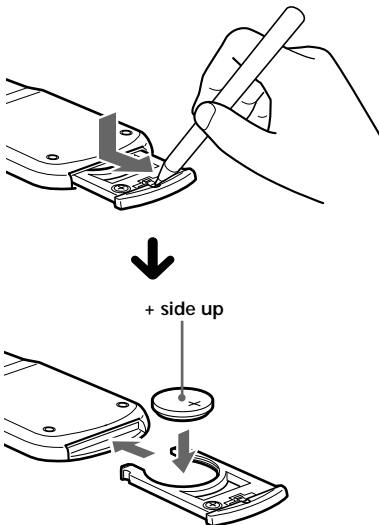

Notes on lithium battery

- Keep the lithium battery out of the reach of children. Should the battery be swallowed, immediately consult a doctor.
- Wipe the battery with a dry cloth to assure a good contact.
- Be sure to observe the correct polarity when installing the battery.
- Do not hold the battery with metallic tweezers, otherwise a short-circuit may occur.

WARNING

Battery may explode if mistreated. Do not recharge, disassemble, or dispose of in fire.

Getting Started

Attaching the front panel

Place the hole (A) of the front panel onto the spindle (B) on the unit as illustrated, then push the left side in.

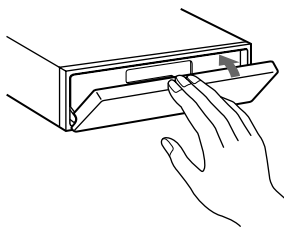
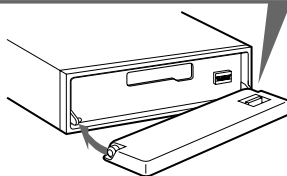
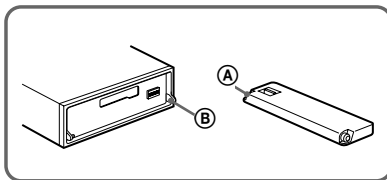

Resetting the unit

Before operating the unit for the first time or after replacing the car battery, you must reset the unit.

Remove the front panel and press the reset button with a pointed object, such as a ball-point pen.



Reset button

Note

Pressing the reset button will erase the clock setting, preset memory and some memorized functions.

Detaching the front panel

You can detach the front panel of this unit to protect the unit from being stolen.

- 1 Press **OFF**.
- 2 Press **OPEN**, then slide the front panel to the right side, and pull out from the left side.

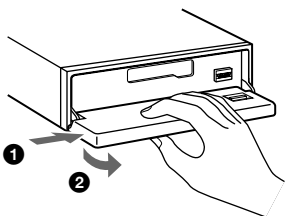

Notes

- Be sure not to drop the panel when detaching it from the unit.
- If you detach the panel while the unit is still turned on, the power will turn off automatically to prevent the speakers from being damaged.
- When you carry the front panel with you, use the supplied front panel case.

Notes

- Be careful not to attach the front panel upside down.
- Do not press the front panel too hard against the unit when attaching it.
- Do not press too hard or put excessive pressure on the display window of the front panel.
- Do not expose the front panel to direct sunlight or heat sources such as hot air ducts, and do not leave it in a humid place. Never leave it on the dashboard of a car parked in direct sunlight or where there may be a considerable rise in temperature.

Caution alarm

If you turn the car ignition off without removing the front panel, the caution alarm will beep for a few seconds.

If you connect an optional power amplifier and do not use the built-in amplifier, the beep sound will be deactivated.

Turning the unit on/off

Turning on the unit

Press **(SOURCE)** or insert a cassette in the unit. For details on operation, refer to page 9 (cassette player) and page 11 (radio).

Turning off the unit

Press **(OFF)** to stop tape playback or FM/AM reception (the key illumination and display remains on.)

Press **(OFF)** for two seconds to completely turn off the unit.

Note

If your car has no ACC position on the ignition key switch, be sure to turn the unit off by pressing **(OFF)** for two seconds to avoid car battery wear.

How to use the menu

This unit is operated by selecting items from a menu.

To select, first enter the menu mode and choose up/down (+/- of **(PRST/DISC)**), or choose left/right (-/+ of **(SEEK/AMS)**).

PRST/DISC

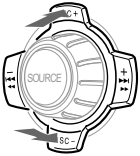

(+) : To select upwards

(-) : To select downwards

SEEK/AMS



(-) : To select leftwards

(+) : To select rightwards

Setting the clock

The clock uses a 12-hour digital indication.

Example: To set the clock to 10:08

- 1 Press **(MENU)**, then press either side of **(PRST/DISC)** repeatedly until "CLOCK" appears.

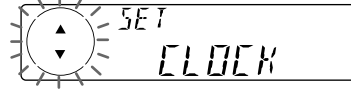

- 1 Press **(ENTER)**.

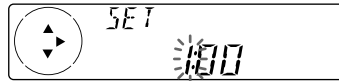

The hour indication flashes.

- 2 Press either side of **(PRST/DISC)** to set the hour.



- 3 Press (+) side of **(SEEK/AMS)**.

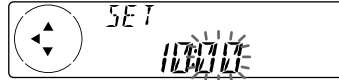

The minute indication flashes.

- 4 Press either side of **(PRST/DISC)** to set the minute.



- 2 Press **(ENTER)**.



The clock starts.

After the clock setting is complete, the display returns to normal playback mode.

Tip

When the D.INFO mode is set to ON, the time is always displayed (page 15).

Cassette Player

Listening to a tape

- 1 Press **OPEN** and insert a cassette.
Playback starts automatically.

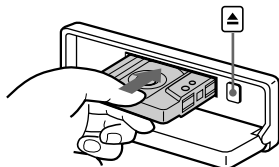

- 2 Close the front panel.

If a cassette is already inserted, to start playback, press **SOURCE** repeatedly until "FWD" or "REV" appears.

The side facing up is played.

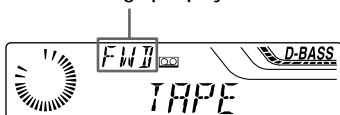

The side facing down is played.



Tip
To change the tape's playback direction, press **MODE** (◀▶).

To	Press
Stop playback	OFF
Eject the cassette	OPEN then ▲

Fast-winding the tape

During playback, press and hold either side of **SEEK/AMS**.

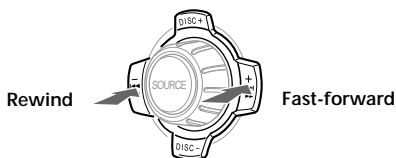

To start playback during fast-forwarding or rewinding, press **MODE** (◀▶).

Locating a specific track

— Automatic Music Sensor (AMS)

During playback, press either side of **SEEK/AMS** momentarily for each track you want to skip.

You can skip up to nine tracks at one time.

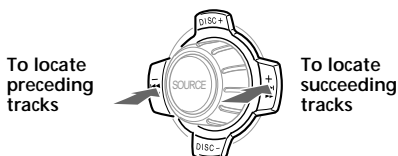

Note

The AMS function may not work when:

- the blanks between tracks are shorter than four seconds
- there is noise between tracks
- there are long sections of low volume or quiet sections.

In the Motion Display mode, all the items are scrolled in the display one by one in order.

Tip

The Motion Display mode can be turned off. (See "Changing the sound and display settings" on page 15.)

Playing a tape in various modes

You can play the tape in various modes:

- REP (Repeat Play) repeats the current track.
- BL SKP (Blank Skip) skips blanks longer than eight seconds.
- ATA (Automatic Tuner Activation) turns on the tuner automatically when fast-winding the tape.

1 During playback, press (MENU).

2 Press either side of (PRST/DISC) repeatedly until the desired item appears.

Each time you press (-) side of (PRST/DISC), the item changes as follows:

BL SKP → ATA



3 Press (+) side of (SEEK/AMS) to select "ON."



Play mode starts.

4 Press (ENTER).

To return to normal playback mode, select "OFF" in step 3.

Tip
While the ATA function is activated, the display (TAPE ↔ TUNER) can be changed by pressing (DSPL).

Playing tracks repeatedly

— Repeat Play

During playback, press (1) (REP) repeatedly until "REP-ON" in the display appears.

REP-ON ↔ REP-OFF

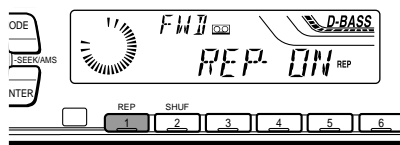

Repeat Play starts.

To return to normal playback mode, select "REP-OFF."

Tip
During repeat playback, press (MODE). "REP" disappears from the display and repeat mode is canceled.

Radio

Memorizing stations automatically

— Best Tuning Memory (BTM)

The unit selects the stations with the strongest signals and memorizes them in the order of their frequencies. You can store up to 6 stations on each band (FM1, FM2, FM3, AM1, and AM2).

Caution

When tuning in stations while driving, use Best Tuning Memory to prevent accidents.

- 1 Press **(SOURCE)** repeatedly to select the tuner.

Each time you press **(SOURCE)**, the source changes as follows:

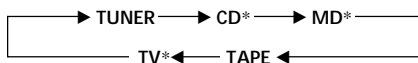

* If the corresponding optional equipment is not connected, this item will not appear.

- 2 Press **(MODE)** repeatedly to select the band.

Each time you press **(MODE)**, the band changes as follows:



- 3 Press **(MENU)**, then press either side of **(PRST/DISC)** repeatedly until "BTM" appears.

- 4 Press **(ENTER)**.

The unit stores stations in the order of their frequencies on the number buttons.

A beep sounds when the setting is stored.

Notes

- The unit does not store stations with weak signals. If only a few stations can be received, some number buttons will retain their former setting.
- When a number is indicated in the display, the unit starts storing stations from the one currently displayed.

Memorizing only the desired stations

You can preset up to 18 FM stations (6 each for FM1, 2, and 3) and up to 12 AM stations (6 each for AM1 and 2) in the order of your choice.

- 1 Press **(SOURCE)** repeatedly to select the tuner.
- 2 Press **(MODE)** repeatedly to select the band.
- 3 Press either side of **(SEEK/AMS)** to tune in the station that you want to store on the number button.
- 4 Press the desired number button (**1** to **6**) until "MEM" appears.
The number button indication appears in the display.

Note

If you try to store another station on the same number button, the previously stored station will be erased.

Receiving the memorized stations

- 1 Press **(SOURCE)** repeatedly to select the tuner.
- 2 Press **(MODE)** repeatedly to select the band.
- 3 Press the number button (**(1)** to **(6)**) on which the desired station is stored.

Tip

Press either side of **(PRST/DISC)** to receive the stations in the order they are stored in the memory (Preset Search Function).

If you cannot tune in a preset station

Press either side of **(SEEK/AMS)** to search for the station (automatic tuning).

Scanning stops when the unit receives a station. Press either side of **(SEEK/AMS)** repeatedly until the desired station is received.

Note

If the automatic tuning stops too frequently, press **(MENU)**, then press either side of **(PRST/DISC)** repeatedly until "LOCAL" (local seek mode) is displayed. Then press (+) side of **(SEEK/AMS)** to select "LOCAL-ON." Press **(ENTER)**. During local reception and station selection, "L.SEEK" appears in the display. Only the stations with relatively strong signals will be tuned in.

Tip

If you know the frequency of the station you want to listen to, press and hold either side of **(SEEK/AMS)** until the desired frequency appears (manual tuning).

If FM stereo reception is poor

— Monaural Mode

- 1 During radio reception, press **(MENU)**, then press either side of **(PRST/DISC)** repeatedly until "MONO" appears.
- 2 Press (+) side of **(SEEK/AMS)** until "MONO-ON" appears. The sound improves, but becomes monaural ("ST" disappears).
- 3 Press **(ENTER)**.

To return to normal mode, select "MONO-OFF" in step 2.

If FM stereo broadcast becomes monaural

If interference occurs, the "IF AUTO" function of this unit will automatically avoid noise and narrow the reception frequency. In such cases, some FM stereo broadcasts may become monaural. If you would like to listen to such broadcasts in stereo, manually switch to the "WIDE" setting.

- 1 During radio reception, press **(MENU)**, then press either side of **(PRST/DISC)** repeatedly until "IF AUTO" appears.
- 2 Press (+) side of **(SEEK/AMS)** until "WIDE" appears.
- 3 Press **(ENTER)**.

Note

When you widen the frequency signal reception setting ("WIDE" mode), some interference may occur.

In the Motion Display mode, all the items are scrolled in the display one by one in order.

Tip

The Motion Display mode can be turned off. (See "Changing the sound and display settings" on page 15.)

Other Functions

You can also control this unit with the rotary commander.

Labeling the rotary commander

Depending on how you mount the rotary commander, attach the appropriate label as shown in the illustration below.

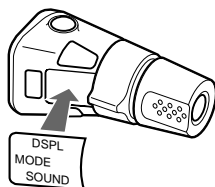
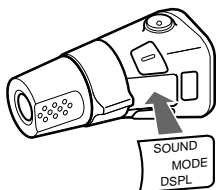

Using the rotary commander

The rotary commander works by pressing buttons and/or rotating controls.

You can also control the optional CD or MD units with the rotary commander.

By pressing buttons (the SOURCE and MODE buttons)

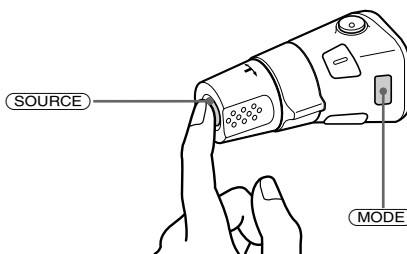

Each time you press **SOURCE**, the source changes as follows:

TUNER → CD* → MD* → TAPE → TV*

Pressing **MODE** changes the operation in the following ways;

- Tuner : FM1 → FM2 → FM3 → AM1 → AM2
- Tape : playback direction
- TV/Video*: TV1 → TV2 → AUX
- CD unit* : CD1 → CD2 → ...
- MD unit* : MD1 → MD2 → ...

* If the corresponding optional equipment is not connected, the item will not appear.

continue to next page →

By rotating the control (the SEEK/AMS control)

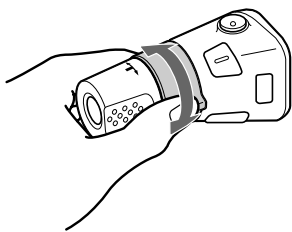

Rotate the control and release it to:

- Locate the beginnings of tracks on the tape. Rotate and hold the control, and release it to fast-wind the tape. To start playback while fast-winding the tape, press **(MODE)**.
- Locate a specific track on a disc. Rotate and hold the control until you locate the specific point in a track, then release it to start playback.
- Tune in stations automatically. Rotate and hold the control to find a specific station.

By pushing in and rotating the control (the PRESET/DISC control)

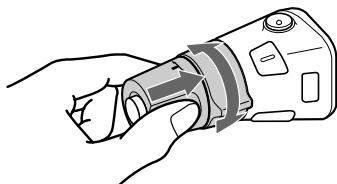

Push in and rotate the control to:

- Receive the stations memorised on the number buttons.
- Change the disc.

Other operations

Rotate the VOL control to adjust the volume.

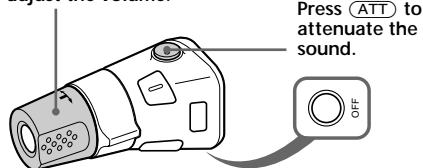

Press **(ATT)** to attenuate the sound.

Press **(OFF)** to turn off the unit.

Note

When installing in a car without ACC (accessory) position on the ignition key switch, press **(OFF)** for two seconds to turn off the clock display after turning off the engine.

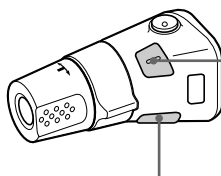

Press **(SOUND)** to adjust the volume and sound menu.

Press **(DSPL)** to change the displayed items.

Tip

While the ATA function is activated, the display (TAPE ↔ TUNER) can be changed by pressing **(DSPL)**.

Changing the operative direction

The operative direction of controls is factory-set as shown below.

To increase

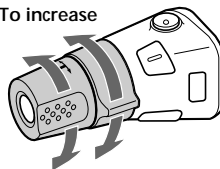

To decrease

If you need to mount the rotary commander on the right hand side of the steering column, you can reverse the operative direction.

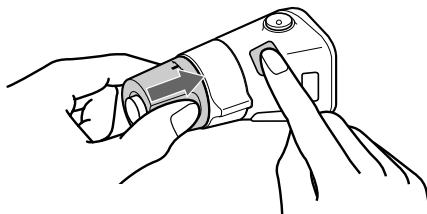

Press **(SOUND)** for two seconds while pushing the VOL control.

Tip

You can also change the operative direction of these controls with the unit (see "Changing the sound and display settings" on page 15).

Adjusting the sound characteristics

You can adjust the bass, treble, balance, and fader.

You can store the bass and treble levels independently for each source.

1 Select the item you want to adjust by pressing **(SOUND)** repeatedly.

Each time you press **(SOUND)**, the item changes as follows:

BAS (bass) → TRE (treble) →

BAL (left-right) → FAD (front-rear)

2 Adjust the selected item by pressing either side of **(SEEK/AMS)**.

When adjusting with the rotary commander, press **(SOUND)** and rotate the VOL control.

Note

Adjust within three seconds after selecting the item.

Changing the sound and display settings

The following items can be set:

- CLOCK (page 8).
- BEEP – to turn the beep sound on or off.
- RM (Rotary Commander) – to change the operative direction of the rotary commander.
 - Select “NORM” to use the rotary commander as the factory-set position.
 - Select “REV” when you mount the rotary commander on the right side of the steering column.
- D.INFO (Dual Information)*¹ – to display the clock and the play mode simultaneously (ON), or to display the information alternately (OFF).
- M.DSPL (Motion Display) – to turn the motion display on or off.
- A.SCRL (Auto Scroll)*² (page 17).

1 Press **(MENU)**.

2 Press either side of **(PRST/DISC)** repeatedly until the desired item appears.

Each time you press (–) side of **(PRST/DISC)**, the item changes as follows:

CLOCK → BEEP → RM → D.INFO*¹
→ M.DSPL → A.SCRL*²

*¹ When the radio is off, or when no tape, CD, or MD is playing, this item will not appear.

*² When no CD or MD is playing, this item will not appear.

Note

The displayed item will differ depending on the source.

Tip

You can easily switch among categories (“SET,” “DIS,” “P/M” and “EDT”) by pressing an holding either side of **(PRST/DISC)** for two seconds.

3 Press (+) side of **(SEEK/AMS)** to select the desired setting (Example: ON or OFF).

4 Press **(ENTER)**.

After the mode setting is complete, the display returns to normal playback mode.

Boosting the bass sound

— D-bass

You can enjoy a clear and powerful bass sound. The D-bass function boosts the low frequency signal and high frequency signal with a sharper curve than conventional bass boost.

You can hear the bass line more clearly even while the vocal volume remains the same. You can emphasize and adjust the bass sound easily with the D-BASS button.

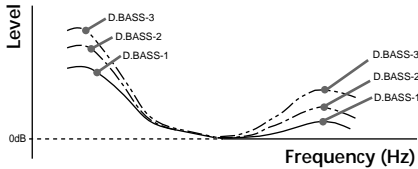

Adjusting the bass curve

Press **(D-BASS)** repeatedly to select the desired bass curve.

As the D-BASS number increases so does the effect.

D.BASS-1 → D.BASS-2 → D.BASS-3 →
D.BASS-OFF (cancel)

Note

The bass sound may distort at same volume. If the bass sound distorts, select less effective bass curve.

With Optional Equipment CD/MD Unit

This unit can control external CD/MD units. If you connect an optional CD unit with the CD TEXT function, the CD TEXT information will appear in the display when you play a CD TEXT disc.

Playing a CD or MD

- 1 Press **(SOURCE)** repeatedly to select CD or MD.
- 2 Press **(MODE)** until the desired unit appears.
CD/MD playback starts.

When a CD/MD unit is connected, all the tracks play from the beginning.

Changing the display item

Each time you press **(DSPL)** during CD, CD TEXT, or MD playback, the item changes as follows:

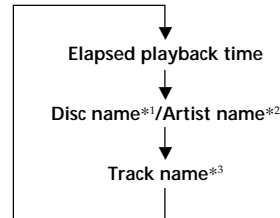

- *1 If you have not labeled the disc or if there is no disc name prerecorded on the MD, "DISC" and "NO NAME" appears in the display.
- *2 If you play a CD TEXT disc, the artist name appears in the display after the disc name. (Only for CD TEXT discs with the artist name.)
- *3 If the track name of a CD TEXT disc or MD is not prerecorded, "TRACK" and "NO NAME" appears in the display.

After you select the desired item, the display will automatically change to the Motion Display mode after a few seconds. In the Motion Display mode, all the items are scrolled in the display one by one in order.

Tip
The Motion Display mode can be turned off. (See "Changing the sound and display settings" on page 15.)

Automatically scrolling a disc name — Auto Scroll

If the disc name, artist name, or track name on a CD TEXT disc or MD exceeds 8 characters and the Auto Scroll function is on, information automatically scrolls across the display as follows:

- The disc name appears when the disc has changed (if the disc name is selected).
- The track name appears when the track has changed (if the track name is selected).

If you press **(DSPL)** to change the display item, the disc or track name of the CD TEXT disc or MD is scrolled automatically whether you set the function on or off.

- 1 During playback, press **(MENU)**.
- 2 Press either side of **(PRST/DISC)** repeatedly until "A.SCRL" appears.
- 3 Press (+) side of **(SEEK/AMS)** to select "A.SCRL-ON."
- 4 Press **(ENTER)**.

To cancel Auto Scroll, select "A.SCRL-OFF" in step 3.

Note
For some discs with very many characters, the following cases may happen:
— Some of the characters are not displayed
— Auto Scroll does not work.

Locating a specific track — Automatic Music Sensor (AMS)

During playback, press either side of **(SEEK/AMS)** momentarily for each track you want to skip.

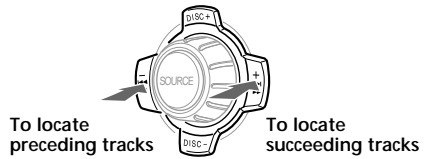

Locating a specific point in a track — Manual Search

During playback, press and hold either side of **(SEEK/AMS)**. Release when you have found the desired point.

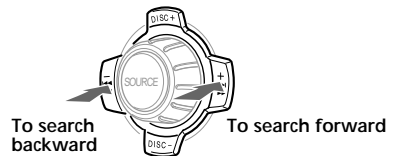

Switching to other discs

During playback, press either side of **(PRST/DISC)**. The desired disc in the current unit begins playback.

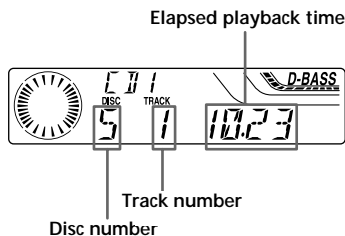
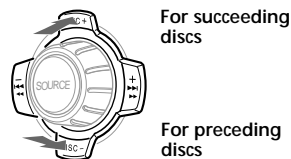

Playing tracks repeatedly

— Repeat Play

You can select:

- REP-1 – to repeat a track.
- REP-2 – to repeat a disc.

During playback, press **(1)** (REP) repeatedly until the desired setting appears.



Repeat Play starts.

To return to normal playback mode, select "REP-OFF."

Playing tracks in random order

— Shuffle Play

You can select:

- SHUF-1 – to play the tracks on the current disc in random order.
- SHUF-2 – to play the tracks in the current unit in random order.
- SHUF-ALL* – to play all the tracks in all the units in random order.

During playback, press **(2)** (SHUF) repeatedly until the desired setting appears.

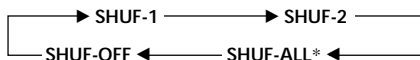

Shuffle Play starts.

* "SHUF-ALL" is only available when you connect two or more optional CD/MD units.

To return to normal playback mode, select "SHUF-OFF."

TV/Video

You can connect an optional TV tuner and TV monitor to this unit.

Watching the TV

- 1 Press **(SOURCE)** repeatedly until "TV" appears.
- 2 Press either side of **(PRST/DISC)** repeatedly to select the desired TV band.

Tip

Each time you press **(MODE)**, the item changes as follows: TV1 → TV2 → AUX

Watching a video

- 1 Press **(SOURCE)** repeatedly until "TV" appears.
- 2 Press **(MODE)** repeatedly to select "AUX."
Playback the video.

Memorizing TV channels automatically

The unit selects the TV channels with the strongest signals and memorizes them in the order of their frequency.

Caution

When tuning in a station while driving, use Best Tuning Memory to prevent accidents.

- 1 Press **(SOURCE)** repeatedly until "TV" appears.
- 2 Press **(MENU)**, then press either side of **(PRST/DISC)** until "AUTO MEM" appears.
- 3 Press **(ENTER)**.
The unit stores TV channels in the order of their frequencies on the number buttons. A beep sounds when the setting is stored.

Notes

- The unit does not store TV channels with weak signals. If only a few TV channels can be received, some number buttons will remain empty.
- When a preset number is indicated in the display, the unit starts storing TV channels from the one currently displayed.

Memorizing only the desired TV channels

You can store up to 12 channels (6 each for TV1 and 2) on the number buttons in the order of your choice.

- 1 Press **(SOURCE)** repeatedly until "TV" appears.
- 2 Press either side of **(SEEK/AMS)** to tune in the TV channel you want to store on each number button.
- 3 Press and hold the desired number button (**1** to **6**) until you hear a beep sound.
The number button indication and "MEM" appears in the display.

Note

If you try to store another channel on the same number button, the previously stored channel will be erased.

Watching the TV or video while listening to a tape, CD or MD — Simultaneous Play

The simultaneous play function does not work while you are listening to the radio.

- 1 Press **(MENU)**, then press either side of **(PRST/DISC)** repeatedly until "SML-SEL" appears.



- 2 Press **(ENTER)**.

continue to next page →

Additional Information

- 3 Press (-) side of (SEEK/AMS).



- 4 Press (SOURCE) repeatedly to select CD or MD.



- 5 Press (+) side of (SEEK/AMS).



- 6 Press (SOURCE) repeatedly to select a TV or video.



- 7 Press (ENTER).
Simultaneous Play starts.

If you are already watching the TV or video and want to listen to a tape, CD or MD as well, follow the same steps.

Returning to normal mode

To cancel the CD or MD, select "-- --" in step 4.

To cancel the TV or video, select "-- --" in step 6.

Note

If you press ▲ (EJECT) on this unit or a CD/MD unit while the unit is in simultaneous play mode, Simultaneous Play is canceled.

Maintenance

Fuse replacement

When replacing the fuse, be sure to use one matching the amperage rating stated on the original fuse. If the fuse blows, check the power connection and replace the fuse. If the fuse blows again after replacement, there may be an internal malfunction. In such a case, consult your nearest Sony dealer.

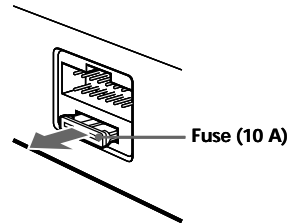

Warning

Never use a fuse with an amperage rating exceeding the one supplied with the unit as this could damage the unit.

Cleaning the connectors

The unit may not function properly if the connectors between the unit and the front panel are not clean. In order to prevent this, open the front panel by pressing (OPEN), then detach it and clean the connectors with a cotton swab dipped in alcohol. Do not apply too much force. Otherwise, the connectors may be damaged.

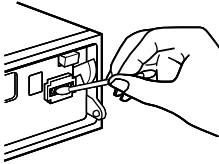

Main unit

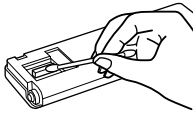

Back of the front panel

Notes

- For safety, turn off the engine before cleaning the connectors and remove the key from the ignition switch.
- Never touch the connectors directly with your fingers or with any metal device.

Dismounting the unit

- 1 Press the clip inside the front cover with a thin screwdriver, and pry the front cover free.

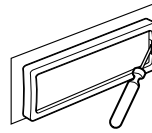

- 2 Repeat step 1 on the left side. The front cover is removed.

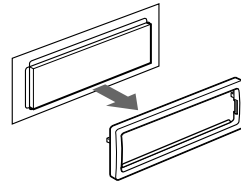

- 3 Use a thin screwdriver to push in the clip on the left side of the unit, then pull out the left side of the unit until the catch clears the mounting.

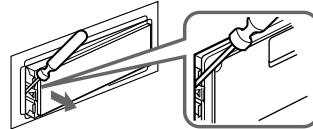

- 4 Repeat step 3 on the right side.

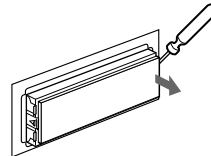

- 5 Slide the unit out of the mounting.

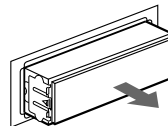

Specifications

AUDIO POWER SPECIFICATIONS

POWER OUTPUT AND TOTAL HARMONIC DISTORTION

19 watts per channel minimum continuous average power into 4 ohms, 4 channels driven from 20 Hz to 20 kHz with no more than 1 % total harmonic distortion.

Other specifications

Cassette player section

Tape track	4-track 2-channel stereo
Wow and flutter	0.08 % (WRMS)
Frequency response	30 – 18,000 Hz
Signal-to-noise ratio	58 dB

Tuner section

FM

Tuning range	87.5 – 107.9 MHz
Antenna terminal	External antenna connector
Intermediate frequency	10.7 MHz/450kHz
Usable sensitivity	8 dBf
Selectivity	75 dB at 400 kHz
Signal-to-noise ratio	66 dB (stereo), 72 dB (mono)

Harmonic distortion at 1 kHz	0.6 % (stereo), 0.3 % (mono)
------------------------------	---------------------------------

Separation	35 dB at 1 kHz
Frequency response	30 – 15,000 Hz

AM

Tuning range	530 – 1,710 kHz
Antenna terminal	External antenna connector
Intermediate frequency	10.7 MHz/450 kHz
Sensitivity	30 μ V

Power amplifier section

Outputs	Speaker outputs (sure seal connectors)
Speaker impedance	4 – 8 ohms
Maximum power output	50 W \times 4 (at 4 ohms)

General

Outputs	Audio output Power antenna relay control lead Power amplifier control lead
Tone controls	Bass \pm 9 dB at 100 Hz Treble \pm 9 dB at 10 kHz
Power requirements	12 V DC car battery (negative ground)
Dimensions	Approx. 178 \times 50 \times 183 mm (7 ¹ / ₈ \times 2 \times 7 ¹ / ₄ in.) (w/h/d)
Mounting dimensions	Approx. 182 \times 53 \times 162 mm (7 ¹ / ₄ \times 2 ¹ / ₈ \times 6 ¹ / ₂ in.) (w/h/d)
Mass	Approx. 1.2 kg (2 lb 10 oz)
Supplied accessories	Parts for installation and connections (1 set) Front panel case (1) Rotary commander RM-X4S Card remote commander RM-X91 BUS cable (supplied with an RCA pin cord) RC-61 (1 m), RC-62 (2 m)
Optional accessories	CD changer (10 discs) CDX-838, CDX-737, CDX-636 MD changer (6 discs) MDX-65 Other CD/MD changers with the Sony-BUS system Source selector XA-C30 TV tuner XT-40V, etc
Optional equipment	

Design and specifications are subject to change without notice.

Troubleshooting guide

The following checklist will help you remedy the problems you may encounter with your unit. Before going through the checklist below, check the connections and operating procedures.

General

Problem	Cause/Solution
No sound.	<ul style="list-style-type: none">• Cancel the ATT function.• Set the fader control to the center position for two-speaker systems.• Rotate the dial clockwise to adjust the volume.
The contents of the memory have been erased.	<ul style="list-style-type: none">• The power cord or battery has been disconnected.• The reset button was pressed. → Store again into the memory.
Indications do not appear in the display.	Remove the front panel and clean the connectors. See "Cleaning the connectors" (page 21) for details.

Tape playback

Problem	Cause/Solution
The sound is distorted.	The tape head is contaminated. → Clean the head with a commercially available dry-type cleaning cassette.
The AMS does not operate correctly.	<ul style="list-style-type: none">• There is noise in the space between tracks.• A blank space is too short (less than four seconds).• A long pause, or a passage of low frequencies or very low sound level is treated as a blank space.

Radio reception

Problem	Cause/Solution
Preset tuning is not possible.	<ul style="list-style-type: none">• Store the correct frequency in the memory.• The broadcast signal is too weak.
Automatic tuning is not possible.	<ul style="list-style-type: none">• The broadcast signal is too weak. → Use manual tuning.• The local seek mode is set to ON. → Set the local seek mode to OFF (page 12).
The stations cannot be received. The sound is hampered by noises.	Connect a power antenna control lead (blue) or accessory power supply lead (red) to the power supply lead of a car's antenna booster. (When your car has built-in FM/AM antenna in the rear/side glass only.)
The "ST" indication flashes.	<ul style="list-style-type: none">• Tune in the frequency accurately.• The broadcast signal is too weak. → Set to the MONO mode (page 12).
Interference occurs during FM reception.	The WIDE mode is selected. → Set the IF mode to IF AUTO (page 12).

continue to next page →

CD/MD playback

Problem	Cause/Solution
The sound skips.	A dirty or defective disc.

Error displays (when an optional CD/MD unit is connected)

The following indications will flash for about five seconds, and an alarm sound will be heard.

Display	Cause	Solution
NO MAG	The disc magazine is not inserted in the CD/MD unit.	Insert the disc magazine in the CD/MD unit.
NO DISC	No disc is inserted in the CD/MD unit.	Insert discs in the CD/MD unit.
NG DISCS	A CD/MD cannot play because of some problem.	Insert another CD/MD.
ERROR * ¹	A CD is dirty or inserted upside down.* ²	Clean or insert the CD correctly.
	An MD does not playback because of some problem.* ²	Insert another MD.
BLANK * ¹	No tracks have been recorded on an MD.* ²	Play an MD with tracks recorded on it.
RESET	The CD/MD unit cannot be operated because of some problem.	Press the reset button of the unit.
NO READY	The lid of the MD unit is open or the MDs are not inserted properly.	Close the lid or insert the MDs properly.
HI TEMP	The ambient temperature is more than 50°C (122°F).	Wait until the temperature goes down below 50°C (122°F).

*¹ When an error occurs during playback of a CD or MD, the disc number of the CD or MD does not appear in the display.

*² The disc number of the disc causing the error appears in the display.

If the above-mentioned solutions do not help improve the situation, consult your nearest Sony dealer.