

SONY®

XS

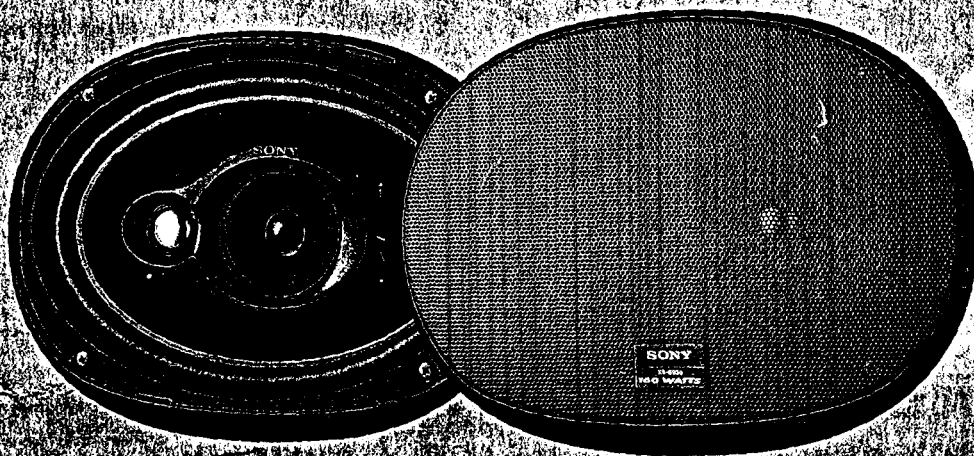





6939

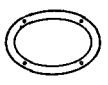

16cm x 24cm (6" x 9") / COAXIAL 3-WAY SPEAKER
16cm x 24cm / HAUT-PARLEUR COAXIAL A 3 VOIES

- High density composite polypropylene cone woofer
- High energy strontium magnet
- Heat resistant voice coil
160 watts max. input power
- Woofer conique en polypropylène composite haute densité
- Aimant puissant au strontium
- Bobine mobile résistante à la chaleur puissance d'entrée maximale 160 watts

Parts List / Liste des pièces

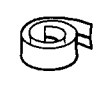
①  × 1	②  × 2	③  × 8	④  × 8	⑤  × 8	⑥  × 8	⑦  × 1
---	---	---	---	---	--	---



Mounting

A Mounting from the car interior (Top mounting)

B Mounting from the trunk (Bottom mounting)

Montage

A Montage à partir de l'intérieur de l'automobile (Montage supérieur)

B Montage à partir du coffre (Montage inférieur)

1

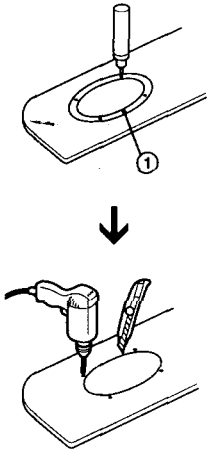

Mark the four bolt holes. Make them 3.2 mm (¹/₃₂ inches) dia. for **A** and 5.5-6 mm (⁷/₃₂ - ¹/₄ inches) dia. for **B**

Marquer les quatre orifices des boulons. Percer des trous de 3.2 mm (¹/₃₂ pouces) de diamètre pour **A** et de 5.5-6 mm (⁷/₃₂ - ¹/₄ pouces) de diamètre pour **B**

2

Black-striped cord
Cordon rayé noir

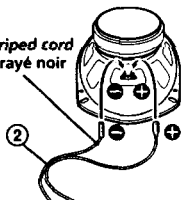

3 A

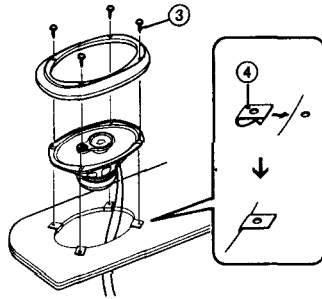

B

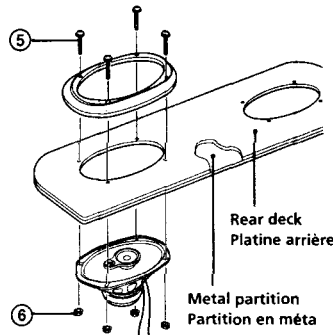

4

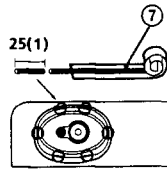

Unit : mm (inches)
Unité : mm (pouces)

Push the edges of the grille net.
Pousser les extrémités du treillis de la grille.

How to remove the grill net.
Comment retirer le treillis de la grille.



Connections

Connexions

Right speaker Left speaker
Haut-parleur droit Haut-parleur gauche

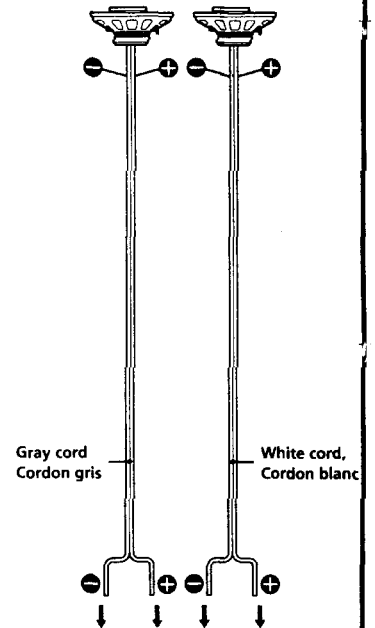

Power amplifier etc.
Amplificateur de puissance etc.

Dimensions
Dimensions

Unit : mm (inches)
Unité : mm (pouces)

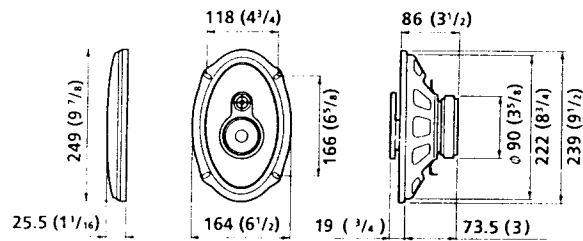

Mounting depth/Profondeur de montage			
A	73.5 mm (3 inches) 73.5 mm (3 pouces)	B	86 mm (3 1/2 inches) 86 mm (3 1/2 pouces)

3-920-118-01
82-000-380-01

Specifications

Speaker	Coaxial 3-way : Woofer 16 x 24 cm (6 x 9 inches), cone type Midrange 6.6 cm (2 5/8 inches), cone type Tweeter 2 cm (1 3/16 inches), dome type
Max. input power	160 watts
Rated power	40 watts
Impedance	4 ohms
Sensitivity	93 dB/W/m
Frequency response	30 - 26,000 Hz
Mass	Approx. 1.3 kg (2 lb 13 oz) per speaker

Design and specifications subject to change without notice.

Spécifications

Haut-parleur	Coaxial à trois voies : Woofer 16 x 24 cm (6 x 9 pouces), type conique Médium 6,6 cm (2 5/8 pouces), type conique Tweeter 2 cm (1 3/16,pouces), type en dôme
Puissance d'entrée max.	160 watts
Puissance admissible	40 watts
Impédance	4 ohms
Sensibilité	93 dB/W/m
Réponse en fréquence	30 - 26.000 Hz
Poids	Env. 1,3kg (2 liv 13 on) par haut-parleur

La conception et les spécifications sont sujettes à des modifications sans préavis.