

Digital Music Player
NW-ZX300/ZX300A



Use this manual when you have trouble or when you need to know how to use your WALKMAN®.

The color of Walkman sold in some countries/regions may differ from those shown above.

This Help Guide is also available as a PDF, which can be downloaded [here](#).

The following contents have been added to this “Help Guide” according to the updates of the Walkman software version 1.10 and later.

aptX HD has been added to the compatible Bluetooth codec.

The contents of the Help Guide may be subject to change without notice due to updates to the product's specifications.

[Getting Started](#)

[Customer registration websites](#)

[Before first use](#)

Walkman manuals and general information

Checking the contents of the package

Configuring the initial setup

Installing Music Center for PC (Windows)

Installing Content Transfer (Mac)

Power/Charging

Turning the Walkman on or off

Preventing unintentional operations (HOLD)

Charging the battery

Extending the battery life

Notes on charging the battery

microSD Cards

Using a microSD card

Notes on microSD cards

Basic Operations

Parts and controls

Screen operations

- How to use the various screens on the Walkman >
- Library screen >
- Playback screen >
- Play Queue screen >
- Bookmark List screen >
- Sound quality setting screens >
- USB-DAC screen >

List of icons displayed in the information area

Adjusting the volume

Volume operation in compliance with European and Korean Directives

Browsing the operating guide

Transferring Music

Preparing music content

Purchasing High-Resolution Audio content

Using a Windows computer

- Transferring content from a Windows computer using Music Center for PC >
- Transferring content using Windows Explorer >
- Importing content from the Walkman to Music Center for PC >

Using a Mac computer

- Transferring content from a Mac computer using Content Transfer >
- Transferring content using Mac Finder >

Adding lyrics information using a computer

Notes on transferring content from a computer

Playing/Organizing/Deleting Music

Playing music

Playback methods

Using [SensMe™ Channels]

Displaying lyrics

- Obtaining lyrics information >
- Displaying lyrics >

Managing playlists on the Walkman

Managing bookmarks on the Walkman

Deleting tracks from the Walkman

Viewing a guide to enjoy high quality sound

Various Functions

Enjoying music through a wireless connection

- Connecting the Walkman to an unpaired Bluetooth device for the first time >
- Connecting the Walkman to a paired Bluetooth device >
- One-touch connections with a Bluetooth device (NFC) >
- Configuring the Bluetooth function >
- Notes on the Bluetooth function >

Enjoying music content on a computer with Walkman sound quality (USB-DAC function)

Adjusting the sound quality settings

Using USB Mass Storage mode

Restarting / Formatting / Initializing

- Restarting the Walkman >
- Resetting/Formatting/Initializing the Walkman >
- Formatting a microSD card >

Version information/System updates

- Checking information on the Walkman >
- Updating the Walkman system software >

Using shortcut buttons from the quick setting panel

Settings menu

Announcement

Notes on handling the Walkman

Notes on the headphones

Notes on the built-in battery

Notes on the software

Notes on the sample data

General Information

Maintenance

Customer support website

Specifications

Specifications

Battery life

Maximum recordable number of songs

Supported formats

System requirements

Troubleshooting

Power/Charging

- The built-in rechargeable battery becomes depleted quickly even after the Walkman is fully charged. >
- What is the battery lifespan? >
- Can I replace the built-in rechargeable battery myself? >

microSD Cards

- The computer does not recognize the microSD card in the Walkman. >
- The Walkman does not recognize a microSD card. >

Playing Music

- A track is duplicated on the Walkman. >
- The Walkman cannot play transferred content. >

Others

- You have spilled liquid (water, coffee, etc.) on the Walkman. >
- You have washed the Walkman in a washing machine. >
- The Walkman does not work properly. >

Digital Music Player
NW-ZX300/ZX300A

Customer registration websites

We recommend that you register the Walkman to get better customer support.

For customers in the US:

<http://www.sony.com/walkmanreg/>

For customers in Canada:

English

<http://www.Sony.ca/Registration>

French

<http://www.Sony.ca/Enregistrement>

For customers in Latin America:

<http://www.sony-latin.com/registration>

For customers in Europe:

www.sony.eu/mysony

For customers in Asia/Oceania/the Middle East/Africa:

English/Korean/Traditional Chinese

<http://www.sony-asia.com/dmpwalkman/register/>

Simplified Chinese

https://www.sonystyle.com.cn/b2c_sony/b2c/productRegister.do

The contents of the Help Guide may be subject to change without notice due to updates to the product's specifications.

Digital Music Player
NW-ZX300/ZX300A

Before first use

Thank you for purchasing a Walkman.

- For information on laws, regulations and trademark rights, refer to “Important Information” contained in the supplied software. To read it, install the supplied software on your computer.
- Before you start using the Walkman, read the topics under [Related Topic].
- All other trademarks and registered trademarks are trademarks or registered trademarks of their respective holders. In this manual, TM and ® marks are not specified.

Before you start using the Walkman, check the following information.

Model names

Several model names appear in this [Help Guide]. Some models are not available depending on the country or region where you purchased the Walkman.

Computer system requirements

When you connect the Walkman to a computer, check the computer system requirements.

Battery charging

The battery might be low when you use the Walkman for the first time. Charge the battery before use.

microSD cards

The following memory cards are referred to as [microSD cards] in this [Help Guide].

- microSD cards
- microSDHC cards
- microSDXC cards

Images and illustrations

The screen images and illustrations shown in this [Help Guide] are for reference only. They may differ from the actual product or onscreen display.

Design and specifications are subject to change without notice.

The contents of the Help Guide may be subject to change without notice due to updates to the product's specifications.

Related Topic

- [Walkman manuals and general information](#)
- [System requirements](#)

- [Charging the battery](#)
- [Notes on handling the Walkman](#)
- [Notes on the headphones](#)
- [Notes on the built-in battery](#)
- [Notes on the software](#)
- [Notes on the sample data](#)
- [General Information](#)
- [Maintenance](#)
- [Customer support website](#)

4-698-041-12(1) Copyright 2017 Sony Corporation

Digital Music Player
NW-ZX300/ZX300A

Walkman manuals and general information

Sony provides the following manuals and information regarding the Walkman.
The provided manuals explain the following operations and functions.

- Basic operations.
- Unique functions that require explanations.
- Complicated operations that require instructions.

Help Guide

This Help Guide provides the standard operating procedures only.

- How to transfer content to the Walkman.
- How to use various functions.
- Notes on using the Walkman.

Startup Guide (printed)

- Basic steps to start listening to music after you purchase the Walkman.

Instruction Manual (printed)

- Notes on using the Walkman
- Compliance information
- How to access [Important Information]

Important Information (supplied with the Walkman memory)

- Information on copyrights, laws, and regulations
To read the file, install the supplied software on your computer.

Customer support website (online)

See [Customer support website] in this [Help Guide].

- The latest information on the Walkman
- FAQ: Frequently Asked Questions

The contents of the Help Guide may be subject to change without notice due to updates to the product's specifications.

Related Topic

- [Customer support website](#)

Digital Music Player
NW-ZX300/ZX300A

Checking the contents of the package

- Walkman (1)
- USB cable (1)
- Startup Guide
- Instruction Manual

Note

- Headphones and a microSD card are not supplied with the Walkman.

The contents of the Help Guide may be subject to change without notice due to updates to the product's specifications.

Digital Music Player
NW-ZX300/ZX300A

Configuring the initial setup

When you turn on the Walkman for the first time, the initial setup wizard will launch. You can set the following items during the initial setup.

- Language
- Date and time

1 Hold down the button (1) for 2 seconds until the Walkman turns on.

The initial setup wizard will launch. Confirm the message and tap .

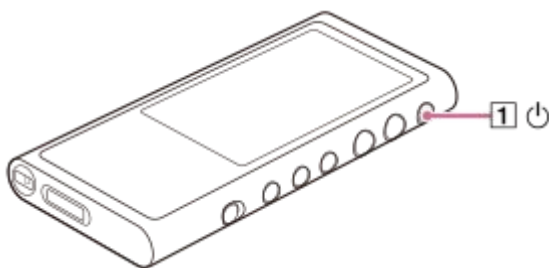

2 Select the language and tap .

3 Set date and time, and then tap .

Follow the onscreen instructions.

You can view the [Guide to High Quality Sound] screen, if you prefer.

Note

- The Walkman does not display a clock. The clock setting is used for data management.

The contents of the Help Guide may be subject to change without notice due to updates to the product's specifications.

Digital Music Player
NW-ZX300/ZX300A

Installing Music Center for PC (Windows)

Music Center for PC is an application for Windows computers. Use the latest version of Music Center for PC. You can use Music Center for PC to perform the following operations.

- Importing content (such as music) from CDs to a computer.
- Organizing and managing the content.
For example, you can create playlists.
- Transferring content on a computer to the Walkman.

Confirm the system requirements before you install Music Center for PC.

1 Access the Music Center for PC download website.

<http://www.sony.net/smc4pc/>

2 Install Music Center for PC.

For details on installation, see [Download] – [Installation procedure] on the Music Center for PC support website. (<http://www.sony.net/smc4pc/>)

The contents of the Help Guide may be subject to change without notice due to updates to the product's specifications.

Related Topic

- [Preparing music content](#)
- [Transferring content from a Windows computer using Music Center for PC](#)
- [System requirements](#)

Digital Music Player
NW-ZX300/ZX300A

Installing Content Transfer (Mac)

Content Transfer is an application for Mac computers. Use the latest version of Content Transfer. You can transfer content that you manage with iTunes or Finder. You can simply drag-and-drop the tracks or albums to transfer them to the Walkman.

Confirm the system requirements before you install Content Transfer.

1 Access the installer for Content Transfer.

<http://www.sony.net/ct-mac/>

2 Open the downloaded file.

[ContentTransfer.dmg] will be saved automatically to the download folder. The folder may open automatically.

3 Install Content Transfer.

Run [ContentTransfer.pkg]. Follow the onscreen instructions. When you finish the installation,  will be displayed.

Note

- Restart the computer if you are prompted. Follow the onscreen instructions.

The contents of the Help Guide may be subject to change without notice due to updates to the product's specifications.

Related Topic

- [Preparing music content](#)
- [Transferring content from a Mac computer using Content Transfer](#)
- [System requirements](#)

Turning the Walkman on or off

1 Hold down the button (1) for 2 seconds until the Walkman turns on.

When you turn on the Walkman for the first time, the initial setup wizard will launch. Follow the onscreen instructions.

You can set the following items during the initial setup.

- Language
- Date and time

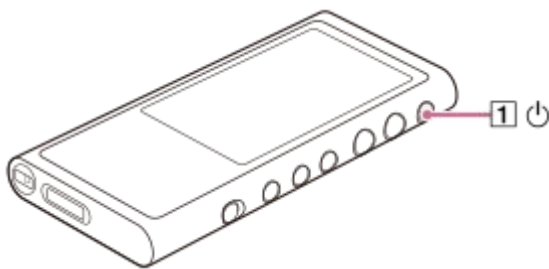

To turn off the Walkman

Hold down the button (1) for 2 seconds while the screen is turned on.

Follow the onscreen instructions to turn off the Walkman.

Release the HOLD function if it is turned on.

Hint

- The screen will turn off automatically if you do not operate the Walkman for a certain period of time. To turn on the screen, press the button (1).
- To conserve the battery power, select [Auto Power Off]. The Walkman will turn off automatically. Tap the menu items in the following order.
[Menu] – [Settings] – [Device Settings] ([Basic Settings]) – [Auto Power Off].

Note

- The Walkman does not display a clock. The clock setting is used for data management.

The contents of the Help Guide may be subject to change without notice due to updates to the product's specifications.

Related Topic

- [Preventing unintentional operations \(HOLD\)](#)
- [Configuring the initial setup](#)

Preventing unintentional operations (HOLD)

You can lock the Walkman to prevent accidental button operation.

1 Slide the switch (1).

The HOLD function is enabled. You cannot operate the buttons on the Walkman or the touch screen. Only the button (2) is active and you can use it to perform the following operations.

- Turning the screen on or off.
- Turning on the Walkman (2 seconds).
- Restarting the Walkman (8 seconds).

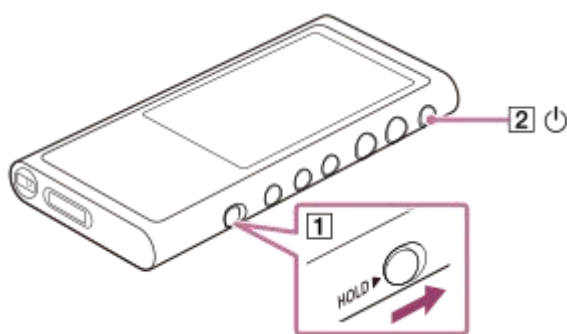

To enable the screen operation

You can enable the touch-screen operation while the HOLD function is active.

1. Tap the menu items in the following order.

 – [Settings] – [Device Settings] ([Basic Settings]).

2. Tap [Disable touch panel when the HOLD switch is on] to remove a check mark.

If you want to prevent accidental touch-screen operations, add a check mark again.

Hint

- Slide the switch (1) in the opposite direction of the arrow to release the HOLD function.
- While the HOLD function is active, **HOLD** will flash when you operate a button.
- When the HOLD function is enabled, you cannot turn off the Walkman. Release the HOLD function.

The contents of the Help Guide may be subject to change without notice due to updates to the product's specifications.

Related Topic

- [Parts and controls](#)

Charging the battery

1 Connect the Walkman to a running computer via USB.

The charge lamp will light up.

When charging is complete, the battery status icon switches to **FULL**.

Then, the charge lamp turns off.



2 Disconnect the Walkman from the computer.

Hint

- For details on how long it takes to charge the battery fully, see [Specifications].

Note

- If the Walkman battery level is not sufficient, the computer will not recognize the Walkman. The Walkman screen will not turn on in this case. If this happens, charge the battery fully. It may take about 10 minutes before the Walkman screen turns on.

The contents of the Help Guide may be subject to change without notice due to updates to the product's specifications.



Related Topic

- [Extending the battery life](#)
- [Notes on charging the battery](#)
- [Specifications](#)

Digital Music Player
NW-ZX300/ZX300A

Extending the battery life

You can reduce the battery consumption by using the Walkman in the following manner.
The battery life depends on usage conditions. For details on the battery life, see [Battery life].

- Turn off the power manually when you do not use the Walkman.
- Set [Auto Power Off]. The Walkman will turn off automatically.
( – [Settings] – [Device Settings] ([Basic Settings]) – [Auto Power Off].)
- Set a shorter time for [Screen Off Timer].
( – [Settings] – [Device Settings] ([Basic Settings]) – [Screen Off Timer].)
- Adjust the screen brightness.
- Set all sound quality settings to off.
- Turn off the Bluetooth function when you are not using it.
- Turn off the NFC function when you are not using it.

The contents of the Help Guide may be subject to change without notice due to updates to the product's specifications.

Related Topic

- [Charging the battery](#)
- [Turning the Walkman on or off](#)
- [Settings menu](#)
- [Sound quality setting screens](#)
- [One-touch connections with a Bluetooth device \(NFC\)](#)
- [Using shortcut buttons from the quick setting panel](#)
- [Notes on the built-in battery](#)
- [Displaying lyrics](#)
- [Battery life](#)

Notes on charging the battery

- The charging time depends on the battery usage conditions.
- When the battery is sufficiently charged but the battery life has dropped to about half of its normal span, the battery may be worn out. Contact the nearest Sony dealer or Sony Service Center.
- The computer may not recognize the Walkman in the following situations.
 - When you connect the Walkman to the computer for the first time.
 - When the Walkman has not been used for a long period of time.
Charge the Walkman for about 10 minutes. The Walkman may start operating normally.
- When the ambient temperature exceeds the recommended range,  appears on the screen and then charging is forcibly terminated. Charge the battery at an ambient temperature from 5 °C to 35 °C (41 °F to 95 °F).
- The battery can be recharged about 500 times from a completely depleted state. The exact number of times may vary depending on the usage conditions.
- To prevent deterioration of the battery, charge the battery at least once every 6 months.
- Charging is not guaranteed when you use a homebuilt or modified computer.
- Charging from a USB hub is only guaranteed when you use a self-powered USB hub that carries an authorized logo.
- Do not connect the Walkman to a computer for a long period of time when the computer is not connected to an AC power supply. Otherwise, the computer's battery may run out.
- While the Walkman is connected to a computer, observe the following cautions. Otherwise, the Walkman may not function properly.
 - Do not turn on the computer.
 - Do not restart the computer.
 - Do not wake the computer from sleep mode.
 - Do not shut down the computer.
- The Walkman may become hot while charging. This is not a malfunction.
- The battery indicator scale does not correspond exactly to the remaining battery level. Refer to the battery indicator as a guide.
- When you charge the Walkman using a computer, do not remove the USB cable while data is transferring. If you disconnect the USB cable, data on the Walkman may be lost.

The contents of the Help Guide may be subject to change without notice due to updates to the product's specifications.

Related Topic

- [Charging the battery](#)
- [Extending the battery life](#)
- [Notes on the built-in battery](#)
- [Battery life](#)

Digital Music Player
NW-ZX300/ZX300A

Using a microSD card

This topic includes instructions for the following operations.

- Inserting a microSD card into the Walkman.
- Removing a microSD card from the Walkman.
- Formatting a microSD card on the Walkman.

To use a microSD card on the Walkman, you first need to format the microSD card on the Walkman.

1 Insert a microSD card.

Open the microSD card slot cover (1).

Insert a microSD card until it clicks into place (2). Make sure to insert the microSD card in the correct direction.

The gold contact pins should face up.

Close the cover (1).

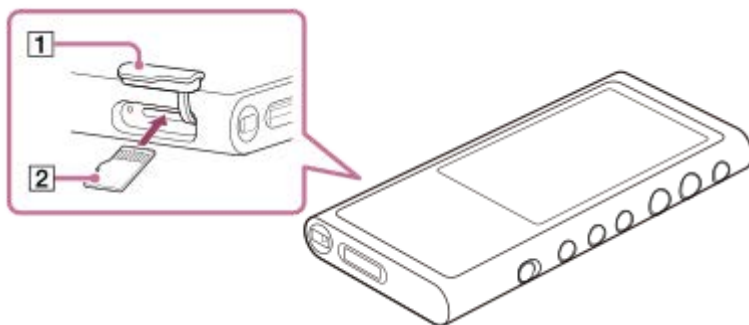

The Walkman will start updating the database.

When the update is complete, the library screen will appear.

2 Format the microSD card.

Tap the menu items in the following order.

 – [Settings] – [Device Settings] ([Basic Settings]) – [Reset/Format] – [Format SD Card].

Follow the onscreen instructions. Make sure to confirm the messages carefully.

To remove the microSD card

Before you remove a microSD card from the Walkman, first unmount the microSD card from the Walkman.

1. On the library screen, tap the menu items in the following order.

 – [Settings] – [Device Settings] ([Basic Settings]) – [Mount/Unmount SD Card] – [OK].

2. Open the microSD card slot cover. Make sure that the access lamp (1) is turned off.



3. Push the microSD card into the microSD card slot.
The microSD card will pop out.

4. Remove the microSD card. Then, close the microSD card slot cover.

Note

- On the Walkman, you cannot exchange data between the Walkman memory and a microSD card.
- If the Walkman does not recognize the microSD card, remove and reinsert the microSD card into the Walkman.
- Do not insert any object other than a microSD card into the microSD card slot.
- If the inserted microSD card contains a large amount of data, it may take about 10 minutes or longer for the Walkman to update the database.
- When you remove the microSD card, the following information will be deleted.
 - The content that is currently being played.
 - The playback position.
 - Tracks and the playback order on the play queue screen
 - Bookmark information for tracks on the microSD card.
- Formatting a microSD card will delete all data stored on the microSD card. Save a back up copy of important data.

The contents of the Help Guide may be subject to change without notice due to updates to the product's specifications.

Related Topic

- [Notes on microSD cards](#)
- [Formatting a microSD card](#)

Notes on microSD cards

- Use a microSD card that has been formatted on the Walkman. Sony does not guarantee the operation of other microSD cards.
- Sony does not guarantee all operations for microSD cards that are used on multiple devices.
- Formatting a microSD card will delete all data stored on the microSD card. Save a backup copy in advance.
- Do not leave a microSD card within the reach of small children. Small children may accidentally swallow the microSD card.
- Unmount the microSD card ([Mount/Unmount SD Card]) from the Walkman before you remove a microSD card. Otherwise, the Walkman may not function properly.
- Sony does not guarantee the operation of all types of compatible microSD cards with the Walkman.
- Data may be corrupted in the following situations.
 - When a microSD card is removed during a read or write operation.
 - When the Walkman is turned off during a read or write operation.
 - When a microSD card is used in a location where there is static electricity or electrical noise.
- Sony assumes no responsibility for any loss or damage of stored data. Sony recommends that you save a backup copy of important data regularly.
- Observe the following cautions when you handle microSD cards.
 - Do not apply strong force to a microSD card.
 - Do not bend a microSD card.
 - Do not drop a microSD card.
 - Do not disassemble a microSD card.
 - Do not modify a microSD card.
 - Do not expose a microSD card to water.
 - Do not leave a microSD card in the hot interior of a car.
 - Do not leave a microSD card in direct sunlight.
 - Do not leave a microSD card near a heater.
 - Do not leave a microSD card in a humid place.
 - Do not leave a microSD card in a location where corrosive substances are present.
- Observe the following cautions regarding the microSD card slot.
 - Insert microSD cards into the microSD card slot in the correct direction.
 - Do not insert any object other than a microSD card into the microSD card slot.

The contents of the Help Guide may be subject to change without notice due to updates to the product's specifications.

Related Topic

- [Using a microSD card](#)
- [Formatting a microSD card](#)

Parts and controls

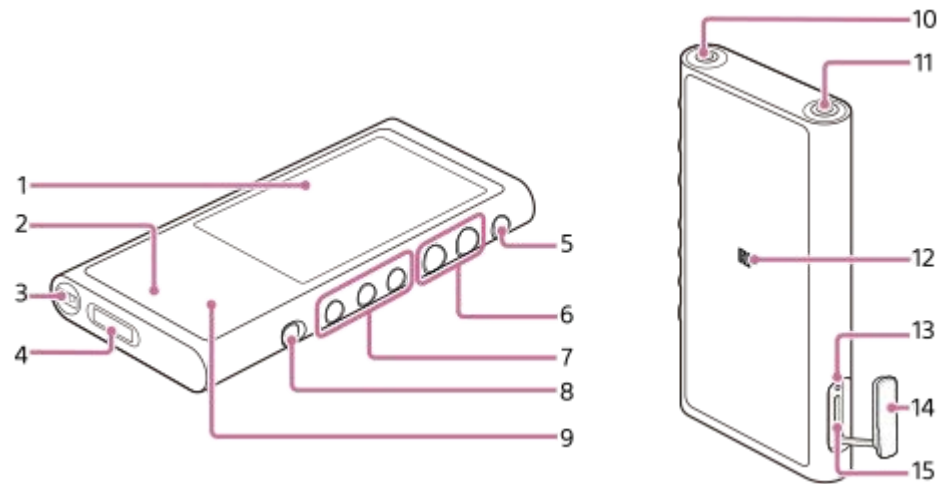

1. Touch screen
Tap icons or items on the screen to operate the Walkman.
2. Charge lamp
The lamp lights up while the Walkman is charging.
3. Strap hole
Attach a wrist strap (not supplied).
4. WM-PORT jack
 - Connect the USB cable (supplied).
 - Connect accessories that support WM-PORT (not supplied).
5. ⏻ (power) button
 - Press the button to turn the screen on or off.
 - Hold down the button for 2 seconds to turn the Walkman on or off.
 - If operations become unstable, hold down the button for 8 seconds to restart the Walkman.
6. + (*1)/- (volume) buttons
Press the buttons to adjust the volume.
7. Playback operating buttons
 - ▶▶ (*1): Press the button to start or pause playback.
 - ◀◀ / ▶▶: Press the buttons to jump within the current track or to the previous or next track.
 - Hold down the buttons to fast-rewind or to fast-forward playback.
8. HOLD switch
Slide the switch to lock the operating buttons on the Walkman. This lets you avoid operating the buttons accidentally.
Locked (inoperable)



Released (operable)



9. Built-in Bluetooth antenna

The antenna allows the Walkman to connect with Bluetooth devices.

Do not cover the antenna when a Bluetooth connection is active. Otherwise, the connection may be interrupted.

10. Headphone jack (Stereo Mini) (*2)

Connect headphones with a stereo mini plug.

Push in the headphone plug until it clicks into place.

Connect the headphones properly. Otherwise, the output sound will be impaired.

11. Headphone jack (Balanced Standard) (*2)

- Connect headphones with a balanced standard plug.

Push in the headphone plug until it clicks into place.

Connect the headphones properly. Otherwise, the output sound will be impaired.

- Connect passive headphones (*3) to the headphone jack (Balanced Standard) only.

If you use an audio cable to connect the headphone jack (Balanced Standard) to the line-in jack of an audio device, it may damage the device.

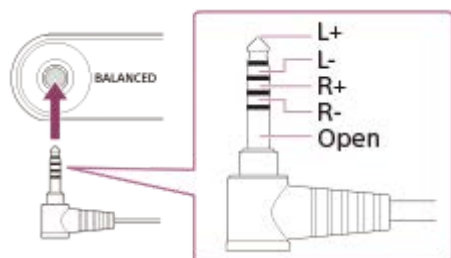

12. N-mark

Touch the N-mark on a Bluetooth device to this mark.

The Bluetooth device must support the NFC function.

You can connect the Bluetooth device to the Walkman.

13. Access lamp

Do not remove the microSD card when the access lamp is lit up.

14. microSD card slot cover

Open the cover to insert a microSD card.

15. microSD card slot

Insert a microSD card until it clicks into place.

Note on the front surface of the Walkman

Matte glass is used on the front surface of the Walkman. The glass prevents the adhesion of fingerprints and lets your fingers slide more easily while you are operating the Walkman.

Matte glass has an uneven surface. Due to this characteristic, it may be difficult to remove scratches or dirt. Make sure not to touch the surface with the following objects.

- Metal products that are made of aluminum or magnesium (headphones, cameras, keyrings, coins, etc.)
- Packaging materials that contain aluminum foil (packaging for gum, chocolate, tablets, etc.)

Sony recommends that you use a case or a pouch to protect the surface of the glass.

*1 There are tactile dots on the ►|| button and the + button. The tactile dots can help you operate the buttons without looking at them.

*2 When headphones are connected to both headphone jacks (Stereo Mini and Balanced Standard), output from one headphone jack (Balanced Standard) will be prioritized.
Disconnect from the Bluetooth connection to use wired headphones.

*3 Passive headphones: Headphones without a Noise Canceling function or Bluetooth function.

The contents of the Help Guide may be subject to change without notice due to updates to the product's specifications.

4-698-041-12(1) Copyright 2017 Sony Corporation

How to use the various screens on the Walkman

This topic explains the layout of the various screens with the playback screen (A) at the center. Flick the playback screen A to switch to other screens (up/down/left/right).

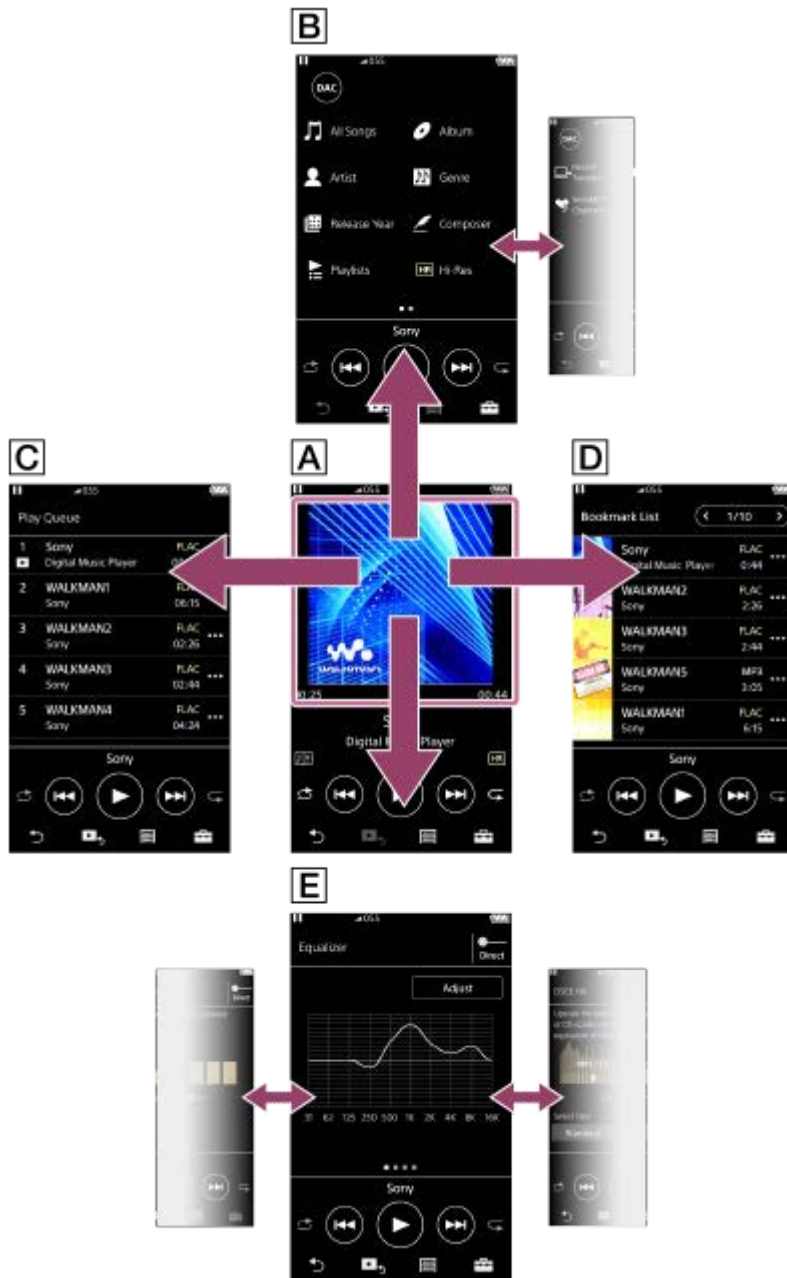

A Playback screen

You can control playback operations from the playback screen. You can also configure various settings for playback.

B Library screen

You can select tracks from the library screen. Tracks are classified into various categories (such as [All Songs], [Album], [Artist], etc.).

You can switch between the USB-DAC function and the music playback function.

C Play Queue screen

You can check the list of tracks that the Walkman will play with the current settings.

D Bookmark List screen

You can listen to tracks that you have registered to a bookmark list beforehand.

You can add tracks to bookmark lists on the playback screen, etc.

The following operations can be performed from this screen.

- Adding tracks to a bookmark list.
- Removing tracks from a bookmark list.
- Changing the order of tracks in a bookmark list.
- Adding tracks to playlists.
- Checking the details of the track information.

E Sound quality setting screens

You can adjust various sound quality settings.

You can save sound quality settings as presets. Up to 3 presets can be stored.

- Equalizer/Tone Control
- DSEE HX
- DC Phase Linearizer
- Dynamic Normalizer





Hint

- You can also configure sound quality settings from the menu. Tap the menu items in the following order.
 – [Settings] – [Sound Settings] ([Sound]).

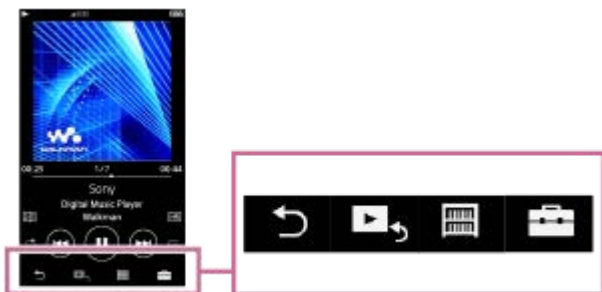
Basic operating buttons

There are 4 basic operating buttons at the bottom of each screen. These buttons may not always be active depending on the screen.











-  (back)
Tap the button to return to the previous screen.
-  (go to playback screen)
Tap the button to return to the playback screen.
-  (library)
Tap the button to display the library screen.
-  (options/settings)
Tap the button to display the option/setting menus.
You can configure various settings for the Walkman.
Available menu items may differ depending on the screen or settings. To configure the basic settings for the Walkman, select the [Settings] menu.

Basic playback operating buttons

There are basic playback operating buttons in the lower area of each screen.



-  (play) /  (pause)
Tap  to start playback.
While the Walkman is playing a track, tap  to pause playback.
-  (fast-rewind)
Tap the button to go back to the beginning of the current track or previous track. Hold down the button to fast-rewind playback.
-  (fast-forward)
Tap the button to jump to the beginning of the next track. Hold down the button to fast-forward playback.
-  (shuffle play)
Tap the button to shuffle playback.
-  (repeat play)
Tap the button to repeat playback. You can choose to repeat one track or all tracks.

Hint

- Drag the timeline bar to change the playback position in a track.

The contents of the Help Guide may be subject to change without notice due to updates to the product's specifications.

Related Topic

- [Library screen](#)
- [Playback screen](#)
- [Play Queue screen](#)
- [Bookmark List screen](#)
- [Sound quality setting screens](#)
- [Playback methods](#)
- [USB-DAC screen](#)

Digital Music Player
NW-ZX300/ZX300A

Library screen

You can select tracks from the library screen. Tracks are classified into various categories (such as [All Songs], [Album], [Artist], etc.).

You can switch between the USB-DAC function and the music playback function.

To display the library screen

Flick the playback screen down.

You can also tap  at the bottom of the screen to display the library screen.



1. Function buttons

You can switch to the following functions.



2. Music categories ([All Songs], [Album], [Artist], etc.)

Each track is classified into several categories. Select a track from the desired category.

3. Page indicator

The number of dots represents the number of available pages.

4. Subcategories

After you select a music category, select a subcategory until you find the desired track.

You can check the codecs for tracks, such as FLAC. Codecs for High-Resolution Audio formats appear in color.

Option/setting menu

Tap  to display the menu.

Available menu items may differ depending on the screen or settings.

 Settings	Select the item to display the Settings menu.
Select Items to Display	Select the item to set which categories to display or not to display.
Reset display item order	Select the item to display the default categories.

Pop-up menu

Tap **...** to display the pop-up menu. **...** appears beside each item in a subcategory list. Available menu items may differ depending on the screen or settings.

Add to Bookmark List	Select the item to add a track or subcategory item to the bookmark list.
Add to Playlist	Select the item to add a track or subcategory item to a playlist.
Detailed Song Information	Select the item to display the details of the track.
Delete	Select the item to delete the selected track, folder, or playlist.
Delete from Playlist	Select the item to remove the selected track from the playlist.

Hint

- You can drag-and-drop the category icons to change the order.
- You can also display the pop-up menu by holding down an item in the list.

The contents of the Help Guide may be subject to change without notice due to updates to the product's specifications.

Related Topic

- [How to use the various screens on the Walkman](#)
- [Playing music](#)

Digital Music Player
NW-ZX300/ZX300A

Playback screen

You can control playback operations from the playback screen. You can also configure various settings for playback.

To display the playback screen

Tap  at the bottom of the screen.

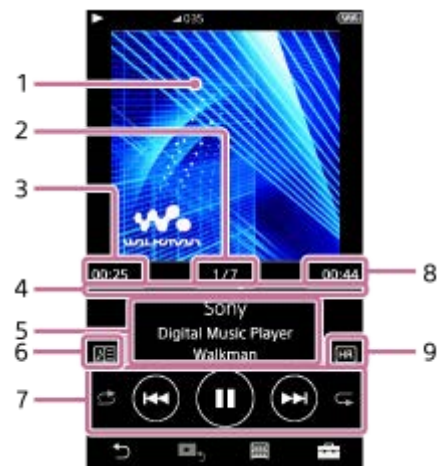

1. Cover art
2. Track number / Total numbers of tracks
3. Elapsed time of the current track
4. Timeline bar
5. Track title / Artist name / Album title
6. Lyrics icon
7. Shuffle button / Previous button / Play (Pause) button / Next button / Repeat button
8. Length of the track
9. High-Resolution Audio icon

Hint

- You can select the playback screen from three different layouts.
 - Standard
 - Spectrum Analyzer
 - Analog Level Meter

Tap  and then [Change Playback Screen].

[Spectrum Analyzer] or [Analog Level Meter] will not be displayed when a Bluetooth connection is active.

- Drag the timeline bar to change the playback position in a track.

Note







- The elapsed time and timeline bar indications may not be accurate.
- The Walkman may not display cover art depending on the file format.

Option/setting menu

Tap  to display the menu.

Available menu items may differ depending on the screen or settings.

Scroll through the menu dialog to display the items listed below.

 Settings	Select the item to display the Settings menu.
 Add to Bookmark List	Select the item to add the current track to a bookmark list.
 Add to Playlist	Select the item to add the current track to a playlist.
 Change Playback Screen	Select the item to change the layout of the playback screen.
 Detailed Song Information	Select the item to display the details of the current track.
 Display Lyrics	Select the item to display the lyrics of the current track.
 View Help	Select the item to view the operating guide.

The contents of the Help Guide may be subject to change without notice due to updates to the product's specifications.

Related Topic

- [How to use the various screens on the Walkman](#)
- [Playing music](#)
- [Playback methods](#)
- [Displaying lyrics](#)
- [Adjusting the sound quality settings](#)

Digital Music Player
NW-ZX300/ZX300A

Play Queue screen

You can check the list of tracks that the Walkman will play with the current settings.

To display the play queue screen

Flick the playback screen to the right.





1. Current track
2. Playback order
3. Pop-up menu icon
4. Track information

- Artist name
- Track title
- Codec
Codecs for High-Resolution Audio formats appear in color.
- Length

Option/setting menu

Tap  to display the menu.

Available menu items may differ depending on the screen or settings.

 Settings	Select to display the Settings menu.
 Add All Songs to Bookmark List	Select the item to add the current play queue to a bookmark list.
 Add All Songs to Playlist	Select the item to add the current play queue to a playlist.

Pop-up menu

Tap  to display the pop-up menu.

Available menu items may differ depending on the screen or settings.

Add to Bookmark List	Select the item to add the selected track to the bookmark list.
Add to Playlist	Select the item to add the selected track to a playlist.
Detailed Song Information	Select the item to display the details of the track.

Hint

- You can also display the pop-up menu by holding down an item in the list.

The contents of the Help Guide may be subject to change without notice due to updates to the product's specifications.

Related Topic

- [How to use the various screens on the Walkman](#)
- [Playing music](#)
- [Playback methods](#)
- [Managing playlists on the Walkman](#)
- [Managing bookmarks on the Walkman](#)

4-698-041-12(1) Copyright 2017 Sony Corporation

Bookmark List screen

You can listen to tracks that you have registered to a bookmark list beforehand.
You can add tracks to bookmark lists on the playback screen, etc.

To display the bookmark list screen

Flick the playback screen to the left.



1. Track information

- Cover art
- Artist name
- Track title
- Codec
- Length

2. Number of the current list





The previous list and the next list buttons

3. Pop-up menu icon

Option/setting menu

Tap  to display the menu.

Available menu items may differ depending on the screen or settings.

 Settings	Select the item to display the Settings menu.
Edit Song Order	Select the item to change the order of tracks in the selected bookmark list. Drag-and-drop  until they are in the desired order.
 Add All Songs to Bookmark List	Select the item to add all tracks in the selected bookmark list to another bookmark list.
 Add All Songs to Playlist	Select the item to add all tracks in the selected bookmark list to a playlist.
Delete All	Select the item to remove all tracks from the selected bookmark list.

Pop-up menu

Tap  to display the pop-up menu.

Available menu items may differ depending on the screen or settings.

Add to Another Bookmark List	Select the item to add the selected track to another bookmark list.
Add to Playlist	Select the item to add the selected track to a playlist.
Delete from Bookmark List	Select the item to remove the selected track from the current bookmark list.
Detailed Song Information	Select the item to display the details of the track.

Hint

- You can also display the pop-up menu by holding down an item in the list.

Note

- When you remove a microSD card from the Walkman, tracks on the microSD card will be removed from the bookmark list.

The contents of the Help Guide may be subject to change without notice due to updates to the product's specifications.

Related Topic

- [How to use the various screens on the Walkman](#)
- [Playing music](#)
- [Playback methods](#)
- [Managing playlists on the Walkman](#)
- [Managing bookmarks on the Walkman](#)

Sound quality setting screens

You can adjust various sound quality settings.

You can save sound quality settings as presets. Up to 3 presets can be stored.

To display the sound quality setting screen

Flick the playback screen up.

To navigate the sound quality setting screens

Flick the screen left or right to select the sound quality setting that you want to adjust.

Tap the Direct switch to turn off the [Direct Source (Direct)] function so that you can flick the screen.

Adjustable sound quality settings

- Equalizer/Tone Control
- DSEE HX
- DC Phase Linearizer
- Dynamic Normalizer

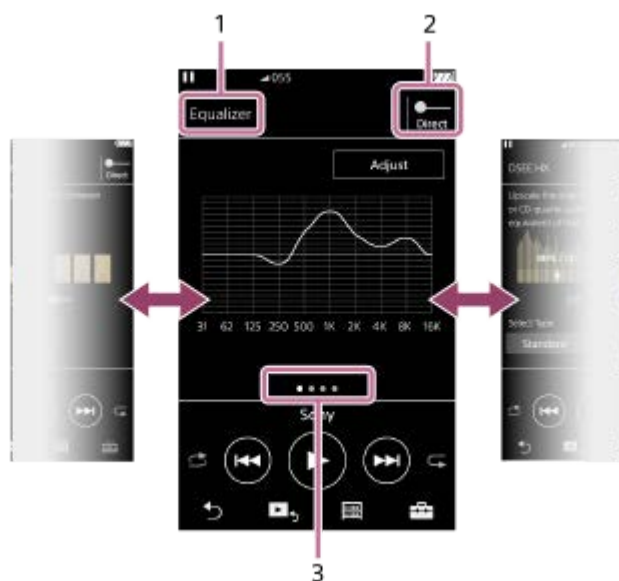

1. Name of the sound quality setting

2. Direct switch

You can turn the [Direct Source (Direct)] function on or off.

3. Page indicator

The number of dots represents the number of available pages. Flick the screen to the left or right to switch to a different page.

Option/setting menu

Tap  to display the menu.

Available menu items may differ depending on the screen or settings.

Saved Sound Settings	Select the item to save or retrieve customized settings.
Tone Control	Select the item to switch from the Equalizer screen to the Tone Control screen.

Equalizer

Select the item to switch from the Tone Control screen to the Equalizer screen.

Hint

- You can flick any of the sound quality setting screens down to return to the playback screen.

The contents of the Help Guide may be subject to change without notice due to updates to the product's specifications.

Related Topic

- [How to use the various screens on the Walkman](#)
- [Adjusting the sound quality settings](#)

4-698-041-12(1) Copyright 2017 Sony Corporation

Digital Music Player
NW-ZX300/ZX300A

USB-DAC screen

You can use the Walkman as a USB-DAC device. Use this function to listen to music on a computer.

To switch to the USB-DAC function

Tap  on the library screen.

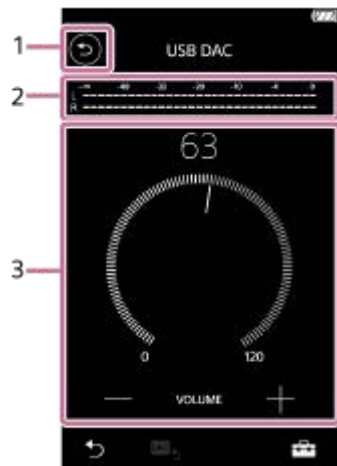

1.  button
Tap the button to switch back to the music playback function.
2. Signal indicator
The indicator reflects the audio signal level of the music content that is being played.
3. Volume knob / VOLUME +/- buttons
You can change the volume.

Option/setting menu

Tap  to display the menu.

 Settings	Select the item to display the Settings menu.
---	---

Hint

- Flick the USB-DAC screen up if you want to change the sound quality settings.

The contents of the Help Guide may be subject to change without notice due to updates to the product's specifications.

Related Topic

- [How to use the various screens on the Walkman](#)

- [Enjoying music content on a computer with Walkman sound quality \(USB-DAC function\)](#)

4-698-041-12(1) Copyright 2017 Sony Corporation

Digital Music Player
NW-ZX300/ZX300A

List of icons displayed in the information area

You can check the playback status and various settings using the icons displayed in the information area. The icons vary depending on the status of the Walkman.



1. Information area

	Volume status
	BALANCED indicator The indicator appears when headphones are connected to the headphone jack (Balanced Standard).
	AVLS
	Playback status Play, pause, find the beginning of the next track, find the beginning of the current or previous track
	HOLD indicator
	Sleep Timer
	Bluetooth
	NFC
	Battery status

Hint

- Tap the information area to open the volume dialog. You can turn the volume knob to adjust the volume.

The contents of the Help Guide may be subject to change without notice due to updates to the product's specifications.

Related Topic

- [Adjusting the volume](#)

4-698-041-12(1) Copyright 2017 Sony Corporation

Digital Music Player
NW-ZX300/ZX300A

Adjusting the volume

Adjusting the volume

On the Walkman: Press the button (1) to adjust the volume.

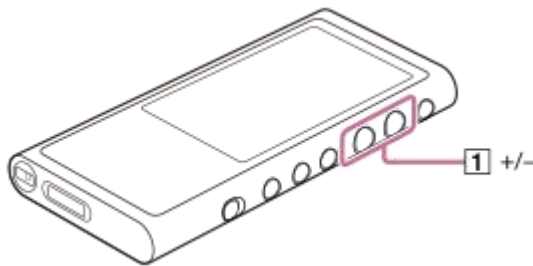

On the screen: Tap the area (1) on the playback screen to display the volume dialog. Turn the knob (2) to adjust the volume. Tap 3 to close the volume dialog.



Hint

- You can also use the +/- buttons at the bottom of the volume dialog to adjust the volume.
- The volume may be low when you use certain headphones. In this case, switch the output setting to [High Gain Output]. To change the setting, tap the menu items in the following order:
[Menu] – [Settings] – [Output Settings] ([Basic Settings]) – [High Gain Output] ([Headphone Output]).
Then, tap the appropriate item for the headphones that you are using. (The menu item is only available on models sold in certain countries or areas.)
- When you switch between the headphone jack (Balanced Standard) and the headphone jack (Stereo Mini), the volume may become unexpectedly loud. To avoid loud volumes, the Walkman may lower the volume automatically.

Limiting the volume

The AVLS (Automatic Volume Limiter System) function reduces the risk of damage to ears from loud volumes. Using AVLS limits the maximum volume. AVLS has the following features.

- AVLS limits the volume to a certain level.
- AVLS prevents disturbances to others caused by loud volumes.

- AVLS allows you to listen at a more comfortable volume.

1. Tap the menu items in the following order.

 – [Settings] – [Output Settings] ([Basic Settings]).

2. Tap [AVLS (Volume Limit)] ([Headphone Output]) to add a check mark.

Note

- [AVLS (Volume Limit)] does not work while there is an active Bluetooth connection.

The contents of the Help Guide may be subject to change without notice due to updates to the product's specifications.

Related Topic

- [Volume operation in compliance with European and Korean Directives](#)

4-698-041-12(1) Copyright 2017 Sony Corporation

Digital Music Player
NW-ZX300/ZX300A

Volume operation in compliance with European and Korean Directives

- For European customers
- For Korean customers (models supplied with headphones)

The alarm (beep) and warning [Check the volume level.] are intended to protect your ears. They occur when you initially turn the volume up to a harmful level. You can cancel the alarm and warning by tapping [OK] on the alert dialog.

Note

- You can turn up the volume after you cancel the alarm and warning.
- After the initial warning, the alarm and warning will repeat every 20 cumulative hours that the volume is set to a level that is harmful to your ears. When this happens, the volume will turn down automatically.
- If you turn off the Walkman after you have selected a high volume that may damage your eardrums, the volume level will automatically be lower when you turn on the Walkman the next time.
- The alarm will not sound when there is an active Bluetooth connection.

The contents of the Help Guide may be subject to change without notice due to updates to the product's specifications.

Related Topic

- [Adjusting the volume](#)

Digital Music Player
NW-ZX300/ZX300A

Browsing the operating guide

You can browse the operating guide to take a quick tour of the operations on the Walkman.

- 1 On the library screen or the playback screen, tap  and then [View Help].

The contents of the Help Guide may be subject to change without notice due to updates to the product's specifications.

Digital Music Player
NW-ZX300/ZX300A

Preparing music content

Before you transfer music content to the Walkman, you need to prepare the content. This topic includes instructions for the following operations.

- Importing content from an audio CD to Music Center for PC.
- Importing content stored on a computer to Music Center for PC.
- Importing content stored on an external media device to a computer.
- Purchasing content from online music services.

The instructions below are for operations using Music Center for PC. Music Center for PC is the recommended application for the Walkman. Install Music Center for PC in advance.

Note

- Imported content is limited to private use only. Use of content for other purposes requires the permission of the copyright holders.
- If you are using a Mac computer, use Content Transfer.

Importing content from an audio CD to Music Center for PC

1. Use a computer on which Music Center for PC has been installed.
2. Launch Music Center for PC.
3. Insert an audio CD into the media drive of the computer.
The content on the audio CD will appear on the Music Center for PC screen.
You can change the format setting for importing CDs, if necessary.
 - For higher sound quality: FLAC
 - For normal sound quality: AAC (.mp4), MP3 (.mp3)

4. Import the content on the audio CD to Music Center for PC.

For details on the procedure, see [How to use] on the Music Center for PC support website.
(<http://www.sony.net/smc4pc/>)

Hint

- You can also use iTunes instead of Music Center for PC to import audio CDs.

Importing content stored on a computer to Music Center for PC

1. Use a computer on which Music Center for PC has been installed.
2. Launch Music Center for PC.
3. From the left pane on the Music Center for PC screen, select the menu for importing content from a computer.
You can specify a folder for the content that you want to import.
4. Start importing the content.

For details on the procedure, see [How to use] on the Music Center for PC support website.
(<http://www.sony.net/smc4pc/>)

Importing content stored on an external media device to a computer

Use an external media device that contains music content.

The following instructions are for Windows Explorer. If you are using a Mac computer, use Finder.

1. Connect the external media device to a computer.
2. Open the external media device in Windows Explorer.
3. Open the [Music] folder of the computer in Windows Explorer.
4. Drag-and-drop the folders or files from the external media device to the [Music] folder on the computer.

Purchasing content from online music services

You can purchase music content from online music services.

Check the service guide for the provider you use. Each service provider has different downloading procedures, compatible file formats, and payment methods. Note that the provider may choose to suspend or terminate the service without notice.

The contents of the Help Guide may be subject to change without notice due to updates to the product's specifications.

Related Topic

- [Installing Music Center for PC \(Windows\)](#)
- [Installing Content Transfer \(Mac\)](#)
- [Transferring content from a Windows computer using Music Center for PC](#)
- [Transferring content using Windows Explorer](#)
- [Transferring content from a Mac computer using Content Transfer](#)
- [Transferring content using Mac Finder](#)
- [Adding lyrics information using a computer](#)
- [Playing music](#)

Digital Music Player
NW-ZX300/ZX300A

Purchasing High-Resolution Audio content

High-Resolution Audio refers to content in a format with higher sound quality than the CD standard. High-Resolution Audio content is available via online music services.

Access an online music service that provides High-Resolution Audio content. Services vary by country or area. Check the service guide for the provider you use. Each service provider has different downloading procedures, compatible file formats, and payment methods.

Note that the provider may choose to suspend or terminate the service without notice.

To transfer High-Resolution Audio content to the Walkman

- On a Windows computer: Use Music Center for PC or Windows Explorer.
- On a Mac computer: Use Content Transfer or Finder.

Hint

- High-Resolution Audio content is indicated with an icon () both on the Walkman and in Music Center for PC.

The contents of the Help Guide may be subject to change without notice due to updates to the product's specifications.

Related Topic

- [Installing Music Center for PC \(Windows\)](#)
- [Installing Content Transfer \(Mac\)](#)
- [Transferring content from a Windows computer using Music Center for PC](#)
- [Transferring content using Windows Explorer](#)
- [Transferring content from a Mac computer using Content Transfer](#)
- [Transferring content using Mac Finder](#)

Transferring content from a Windows computer using Music Center for PC

You can transfer content that is stored on a Windows computer to the Walkman via Music Center for PC.

1 Use a computer on which Music Center for PC has been installed.

2 Launch Music Center for PC.

3 Connect the Walkman to the computer via USB.



4 Click  in the bottom left of Music Center for PC to open the list of content on the Walkman.

To transfer content to the microSD card in the Walkman:

Select the microSD card from the device selection menu. The device selection menu is located above the list of content on the Walkman.

5 Select [Music Library] to open the list of content on Music Center for PC.

6 Select albums or tracks that you want to transfer.

7 Click  to transfer.

For details on the procedure, see [How to use] on the Music Center for PC support website.

(<http://www.sony.net/smc4pc/>)

Note

- Do not disconnect the USB cable during data transfer. Otherwise, the data may be damaged.
- Transferred content is limited to private use only. Use of content for other purposes requires the permission of the copyright holders.
- On the Walkman, you cannot exchange data between the Walkman memory and a microSD card.

Related Topic

- [Installing Music Center for PC \(Windows\)](#)
- [Preparing music content](#)
- [Purchasing High-Resolution Audio content](#)
- [Transferring content using Windows Explorer](#)
- [Playing music](#)

4-698-041-12(1) Copyright 2017 Sony Corporation

Transferring content using Windows Explorer

You can transfer content directly by dragging and dropping it from Windows Explorer.

1 Connect the Walkman to the computer via USB.



2 Open the [WALKMAN] folder as follows.

- Windows 10:
Open [File Explorer] from the [Start] menu. Select [WALKMAN] from the left pane.
- Windows 8.1:
Open [File Explorer] from [Desktop]. Select [WALKMAN] from the list under [This PC].
- Windows 7 or earlier versions:
Select [Start], [Computer], and then [WALKMAN].

You can also transfer content to a microSD card.

Select the folder with the name of the microSD card instead of [WALKMAN].

3 Open the [MUSIC] folder in [WALKMAN].

4 Drag-and-drop the files or folders on the computer to the [MUSIC] folder.

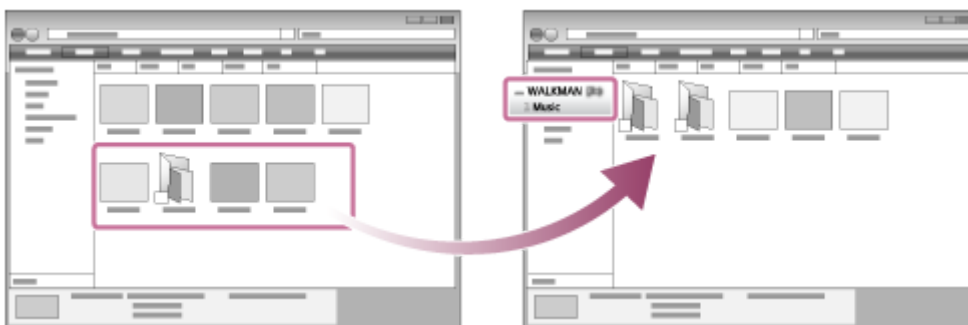

Confirm that the transfer is complete. Then, disconnect the Walkman from the computer.

Note

- Observe the following precautions. Otherwise, the Walkman may not be able to play the files.
 - Do not change the names of the root folders (such as [MUSIC]).
 - Do not transfer the files to folders other than [MUSIC].
 - Do not disconnect the USB cable during data transfer.
 - Do not format the memory of the Walkman on the computer.
- The Walkman may not display music information for some content correctly depending on the language setting on the Walkman.

- Transferred content is limited to private use only. Use of content for other purposes requires the permission of the copyright holders.

The contents of the Help Guide may be subject to change without notice due to updates to the product's specifications.

Related Topic



- [Preparing music content](#)
- [Purchasing High-Resolution Audio content](#)
- [Transferring content from a Windows computer using Music Center for PC](#)
- [Playing music](#)

4-698-041-12(1) Copyright 2017 Sony Corporation

Importing content from the Walkman to Music Center for PC

- 1 Use a computer on which Music Center for PC has been installed.
- 2 Launch Music Center for PC.
- 3 Connect the Walkman to the computer via USB.



- 4 Click  in the bottom left of Music Center for PC to open the list of content on the Walkman.
To import content from the microSD card in the Walkman:
Select the microSD card from the device selection menu. The device selection menu is located above the list of content on the Walkman.
- 5 From the list of content on the Walkman, select the content that you want to import to Music Center for PC.
- 6 Click  in Music Center for PC.

For details on the procedure, see [How to use] on the Music Center for PC support website.
(<http://www.sony.net/smc4pc/>)

Note

- Do not disconnect the USB cable during data transfer. Otherwise, the data may be damaged.
- Imported content is limited to private use only. Use of content for other purposes requires the permission of the copyright holders.

The contents of the Help Guide may be subject to change without notice due to updates to the product's specifications.

Related Topic

- [Installing Music Center for PC \(Windows\)](#)
- [Playing music](#)
- [Supported formats](#)

Transferring content from a Mac computer using Content Transfer

You can use Content Transfer. Content with copyright protection cannot be transferred.

1 Use a computer on which Content Transfer has been installed.

2 Launch Content Transfer.



3 Connect the Walkman to the computer via USB.



4 Select the destination memory on the Walkman (the internal memory or a microSD card).

5 Open Finder or iTunes. Then, select the content.

6 Drag-and-drop the content into Content Transfer.



Confirm that the transfer is complete. Then, disconnect the Walkman from the computer.

- Operation may not be guaranteed depending on the version of iTunes.
- Do not disconnect the USB cable during data transfer. Otherwise, the data may be damaged.
- Transferred content is limited to private use only. Use of content for other purposes requires the permission of the copyright holders.

The contents of the Help Guide may be subject to change without notice due to updates to the product's specifications.

Related Topic

- [Installing Content Transfer \(Mac\)](#)
- [Preparing music content](#)
- [Purchasing High-Resolution Audio content](#)
- [Playing music](#)

4-698-041-12(1) Copyright 2017 Sony Corporation

Transferring content using Mac Finder

You can transfer content directly by dragging and dropping it from Finder. Content with copyright protection cannot be transferred.

1 Connect the Walkman to a running computer via USB.



2 Select [WALKMAN] in the sidebar of the Finder.

You can also transfer content to a microSD card.
Select the folder with the name of the microSD card instead of [WALKMAN].

3 Open the [MUSIC] folder in [WALKMAN].

4 Drag-and-drop the files or folders (1) to the [MUSIC] folder (2) in [WALKMAN].

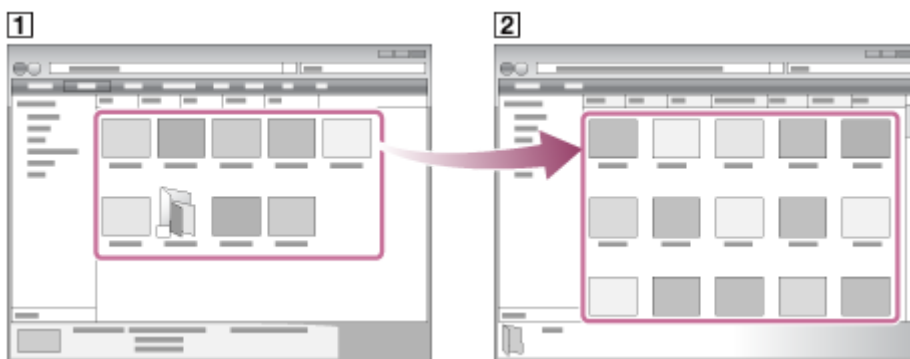

Confirm that the transfer is complete. Then, disconnect the Walkman from the computer.

Note

- Observe the following precautions. Otherwise, the Walkman may not be able to play the files.
 - Do not change the names of the root folders (such as [MUSIC]).
 - Do not transfer the files to folders other than [MUSIC].
 - Do not disconnect the USB cable during data transfer.
 - Do not format the memory of the Walkman on the computer.
- The Walkman may not display music information for some content correctly depending on the language setting on the Walkman.
- Transferred content is limited to private use only. Use of content for other purposes requires the permission of the copyright holders.

The contents of the Help Guide may be subject to change without notice due to updates to the product's specifications.

Related Topic

- [Installing Content Transfer \(Mac\)](#)
- [Preparing music content](#)
- [Purchasing High-Resolution Audio content](#)
- [Playing music](#)

4-698-041-12(1) Copyright 2017 Sony Corporation

Adding lyrics information using a computer

You can input lyrics to a text file (an LRC file). After you input lyrics to tracks, transfer the tracks to the Walkman.

Creating lyrics in a text file (LRC file)

1. Open the [Notepad] in Windows Accessories.
2. Enter the lyrics into [Notepad].
3. Play the track and enter the time to display each line of text.

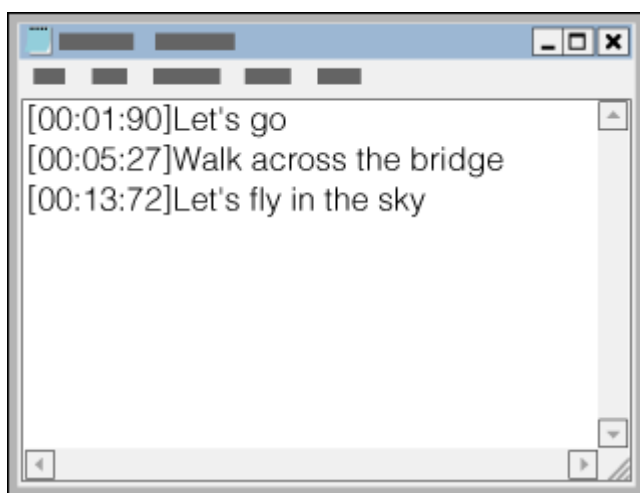

- You can enter the time information to the left of each line of text in the following format.
Minutes:seconds:hundredths of a second (*1)
- Time information must be entered in chronological order.
- You can separate seconds and hundredths of a second using a period instead of a colon.

*1 You can omit hundredths of a second.

4. Save the file.
 - Select [UTF-8] as the character encoding.
 - Set the same file name as the audio file.
 - Set [.lrc] as the extension.
 - The maximum file size is 512 KB.
 - If a text line cannot fit on the screen, it will be wrapped.
 - The number of lines of text that can be displayed simultaneously depends on the Walkman model.
 - CR, CRLF, and LF line breaks are all recognized.
 - Blank text lines will be skipped.
5. Connect your Walkman to the computer via USB.
6. Open the [WALKMAN] folder according to one of the following procedures.
 - Windows 10:
Open [File Explorer] from the [Start] menu. Select [WALKMAN] from the left pane.
 - Windows 8.1:
Open [File Explorer] from [Desktop]. Select [WALKMAN] from the list under [This PC].

- Windows 7 or earlier versions:
Select [Start], [Computer], and then [WALKMAN].

You can also transfer content to a microSD card.

Select the folder with the name of the microSD card instead of [WALKMAN].

7. Create a new folder in the [MUSIC] folder under [WALKMAN]. Then, drag-and-drop both the track and the LRC file into the new folder to transfer them.

Hint

- The following numbers of characters are recommended when you display lyrics on the Walkman.
 - Single-byte characters (for example, alphanumeric characters): 40 characters per line.
 - 2-byte characters (for example, Chinese characters): 20 characters per line.
- To manage LRC files with Music Center for PC, save the LRC files in the same folder as the music files. The LRC files will be transferred to the Walkman when the music files are transferred.
- On a Mac computer, you can create lyrics using “TextEdit” and other text editors. Follow the same procedure as that described above to enter the lyrics or time information in the “Plain text” setting.

Copyright notice

When you create LRC files using copyrighted materials authored by others, the LRC files are limited to private use only. Use of LRC files for other purposes requires the permission of the copyright holders.

The contents of the Help Guide may be subject to change without notice due to updates to the product's specifications.

Related Topic

- [Obtaining lyrics information](#)
- [Displaying lyrics](#)

Digital Music Player
NW-ZX300/ZX300A

Notes on transferring content from a computer

Drag-and-drop content into the correct folder as shown in the following illustration. The Walkman can play back content stored in the first through eighth level of each folder.

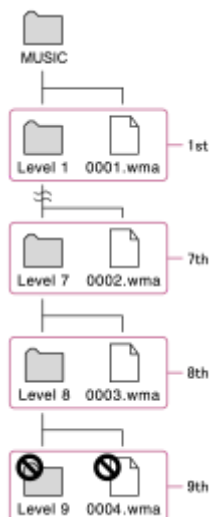

Note

- Do not rename the following default folders. Otherwise, the Walkman will not recognize the folders.
 - MUSIC

The contents of the Help Guide may be subject to change without notice due to updates to the product's specifications.

Playing music

To play tracks, first select a category.

You need to transfer music content from a computer to the Walkman in advance.

On a Windows computer

- Use Music Center for PC to transfer content from a CD or the computer to the Walkman.
- Drag-and-drop content from Windows Explorer.

On a Mac computer

- Use Content Transfer to transfer content from iTunes.
- Drag-and-drop content from Finder.

1 Tap  to open the library screen.

2 Tap the desired category ().

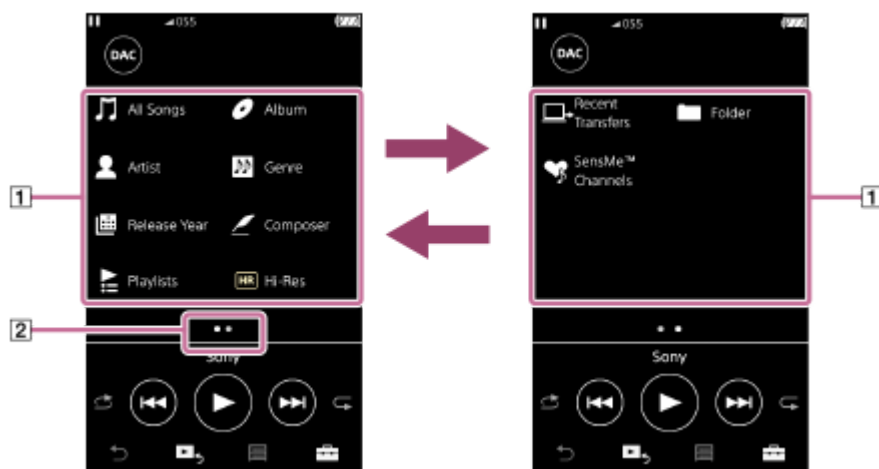

You can flick the screen to the left or right to switch pages. The number of dots represents the number of available pages ().



3 Select subcategories until a track list appears, and then select the desired track.

Playback will start.

Manual buttons on the Walkman

Operation button	Function
	Press the button to start or pause playback.
	Press the button to skip to the beginning of the current track or the previous track. Hold down the button to fast rewind the track while playing.
	Press the button to skip to the beginning of the next track. Hold down the button to fast forward the track while playing.

Note

- If the Walkman does not play tracks in the order you want, try the following.
 - Use the bookmark function or playlist function on the Walkman.
 - Create playlists with Music Center for PC or iTunes and transfer them.

The contents of the Help Guide may be subject to change without notice due to updates to the product's specifications.

Related Topic

- [Turning the Walkman on or off](#)
- [How to use the various screens on the Walkman](#)
- [Installing Music Center for PC \(Windows\)](#)
- [Library screen](#)
- [Playback screen](#)
- [Preparing music content](#)
- [Transferring content from a Windows computer using Music Center for PC](#)
- [Transferring content using Windows Explorer](#)
- [Transferring content from a Mac computer using Content Transfer](#)
- [Transferring content using Mac Finder](#)
- [Playback methods](#)

Playback methods

This topic includes instructions for the following operations.

- Setting the playback mode.
- Setting the playback range.

Setting the playback mode



1. Tap the area (1) or (2) to select a playback mode.

- : Shuffle Playback
- : Repeat 1 Song
- : Repeat All

When and are lit up, the Walkman will play all tracks in the selected playback range randomly. To return to the normal playback mode, tap the icons so that both and darken.

Hint



- You can also set the playback mode from the settings menu. Tap – [Settings] – [Playback Settings] ([Basic Settings]). Then, select the desired playback mode from [Play Mode].

Setting the playback range

1. Tap the menu items in the following order.
 – [Settings] – [Playback Settings] ([Basic Settings]).
2. Tap the desired playback range from [Playback Range].

Diagram of the relationship between playback mode and playback range

Play Mode	Playback Range	
	All Range	Selected Range
	All tracks are played in random order. To shuffle all the tracks on the Walkman, select [All Songs] on the library screen.	Tracks in the selected range

Shuffle Playback	If you select a track from [Album] on the library screen, the Walkman will shuffle all the tracks in the selected album. When the Walkman finishes playing all the tracks in the album, playback will proceed to the next album. Then, the Walkman will shuffle all the tracks in the album.	are played in random order. (*1)
Repeat Off	All tracks are played in sequential order.	Tracks in the selected range are played in sequential order. (*1)
 Repeat 1 Song	The current track is played repeatedly.	The current track is played repeatedly.
 Repeat All	All tracks are played repeatedly. To repeat all the tracks on the Walkman, select [All Songs] on the library screen.	Tracks in the selected range are played repeatedly. (*1)

*1 "Selected range" means one album or one artist, for example.

Note

- When you play a track using the [SensMe™ Channels] function, you cannot change the playback mode.
- When you select a track from a bookmark list, the Walkman plays tracks in the selected bookmark list only. Tracks in other bookmark lists will not be played even when [Playback Range] is set to [All Range].
- When you select a track from a playlist, the Walkman plays tracks in the selected playlist only. Tracks in other playlists will not be played even when [Playback Range] is set to [All Range].

The contents of the Help Guide may be subject to change without notice due to updates to the product's specifications.

Related Topic

- [How to use the various screens on the Walkman](#)
- [Playback screen](#)
- [Playing music](#)

Digital Music Player
NW-ZX300/ZX300A

Using [SensMe™ Channels]

The [SensMe™ Channels] function automatically groups tracks by theme. You can play tracks to suit your mood, current activity, the time of day, and more.

To use the [SensMe™ Channels] function on the Walkman, tracks must be analyzed by Music Center for PC before you transfer the tracks. To analyze tracks, activate the 12 TONE ANALYSIS function on Music Center for PC. The tracks that are imported to Music Center for PC will be automatically analyzed and the results will be set to the tracks. For details on operation, see the Music Center for PC support website.

- 1 On the library screen, tap [SensMe™ Channels].

Hint

- [SensMe™ Channels] can be used for tracks that were transferred from applications that support the 12 TONE ANALYSIS technology (developed by Sony).
- When you open a channel using the [SensMe™ Channels] function or switch to a different channel, the track is played starting from the most melodic or rhythmical section.
- Tracks are played in random order. Each time you select a channel, the order of playback will be different.

Note

- The Walkman only displays channels that contain tracks.

The contents of the Help Guide may be subject to change without notice due to updates to the product's specifications.

Related Topic

- [Library screen](#)

Digital Music Player
NW-ZX300/ZX300A

Obtaining lyrics information

To display lyric information on the Walkman, you need to transfer a lyric text file (LRC file) together with the track file to the Walkman.

You can obtain lyric information in the following ways.

- Obtain lyric information via the Internet, and then create a text file (LRC file).
- Input lyrics to a text file (LRC file) by yourself.

For details on LRC files, refer to the relevant topic under [Related Topic].

Note

- Lyric information is limited to private use only. Use of lyric content for other purposes requires the permission of the copyright holders.

The contents of the Help Guide may be subject to change without notice due to updates to the product's specifications.

Related Topic

- [Displaying lyrics](#)
- [Adding lyrics information using a computer](#)

Digital Music Player
NW-ZX300/ZX300A

Displaying lyrics

Transfer tracks with lyrics information to the Walkman. Then, set the Walkman to display lyrics. When lyrics information is available for a track, an icon () lights up.



- 1 On the playback screen, tap  and then [Display Lyrics].

The contents of the Help Guide may be subject to change without notice due to updates to the product's specifications.

Related Topic

- [Obtaining lyrics information](#)
- [Adding lyrics information using a computer](#)

Managing playlists on the Walkman



You can collect your favorite tracks and save them as playlists on the Walkman. This topic includes instructions for the following operations.

- Adding tracks to playlists on the Walkman.
- Listening to playlists on the Walkman.
- Deleting playlists from the Walkman.

Adding tracks to playlists on the Walkman

Playlists can be saved either in the internal memory of the Walkman or on the microSD card. You cannot add a track from the internal memory to a playlist on the microSD card or vice versa.



1. Perform one of the following.

- While the Walkman is playing or pausing a track that you want to add to a playlist:
On the playback screen, tap  and then [Add to Playlist].
- When a list (track list, album list, play queue, etc.) is displayed:
Tap  beside the desired item in the list to display the pop-up menu. Then, tap [Add to Playlist].

The playlist selection screen will appear.

2. Tap the playlist name to add the track.

Hint

- Up to 999 tracks can be added to a playlist.
- You can add a whole list to a playlist. When the play queue screen or the bookmark list screen is displayed, tap  and then [Add All Songs to Playlist].
- You can change the order of tracks in a playlist. Select a playlist from the library screen. Tap  and then [Edit Song Order]. Drag-and-drop  to rearrange the tracks. Tap [Complete] to save the order of tracks.
- You can transfer playlists created using Music Center for PC or iTunes to the Walkman. Playlists in the m3u file format can be managed on the Walkman.

Note

- You cannot register cover art images for playlists.

Listening to tracks in a playlist on the Walkman

1. On the library screen, tap [Playlists].
2. Tap the desired playlist and then tap the desired track.

Deleting playlists from the Walkman

1. On the library screen, tap [Playlists] to display the list of playlists.
2. Tap  beside the playlist that you want to delete, and then tap [Delete].
3. Follow the onscreen instruction.

Hint

- You can remove a track from a playlist.
Display the list of tracks in the playlist and tap  to display the pop-up menu. Then, select [Delete from Playlist].

Note

- Even if you delete a playlist, the tracks in the playlist will not be deleted from the Walkman.

The contents of the Help Guide may be subject to change without notice due to updates to the product's specifications.

Related Topic

- [Library screen](#)
- [Playback screen](#)
- [Play Queue screen](#)
- [Bookmark List screen](#)

Digital Music Player
NW-ZX300/ZX300A

Managing bookmarks on the Walkman



You can add your favorite tracks to bookmark lists. Up to 10 bookmark lists are available. Up to 999 tracks can be added to a bookmark list.

This topic includes instructions for the following operations.

- Adding tracks to bookmark lists.
- Listening to bookmarked tracks on the Walkman.
- Removing tracks from a bookmark list on the Walkman.

Adding tracks to bookmark lists



1. Perform one of the following.

- While the Walkman is playing or pausing a track that you want to bookmark:
On the playback screen, tap  and then [Add to Bookmark List].
- When a list (track list, album list, play queue, etc.) is displayed:
Tap  beside the desired item in the list to display the pop-up menu. Then, tap [Add to Bookmark List].

The bookmark list selection screen will appear.

2. Select the desired bookmark list.

Hint

- You can add a whole list to a bookmark list. When the play queue screen or the bookmark list screen is displayed, tap  and then [Add All Songs to Bookmark List].
- You can change the order of tracks in a bookmark list.
Select a bookmark list. Tap  and then [Edit Song Order]. Drag-and-drop  to rearrange the tracks. Tap [Complete] to save the order of tracks.

Note

- You cannot import bookmark lists to a computer.

Listening to bookmarked tracks on the Walkman

1. Display the bookmark list screen.

2. Tap  /  to select a list, and then select a track.

Removing tracks from a bookmark list on the Walkman

1. Tap  beside the track in a bookmark list.

2. Tap [Delete from Bookmark List].

Hint

- You can remove all the tracks from a bookmark list.
On the bookmark list screen, tap  and then [Delete All].

The contents of the Help Guide may be subject to change without notice due to updates to the product's specifications.

Related Topic

- [Library screen](#)
- [Playback screen](#)
- [Play Queue screen](#)
- [Bookmark List screen](#)

4-698-041-12(1) Copyright 2017 Sony Corporation

Deleting tracks from the Walkman

You can delete tracks from the Walkman.

1 On the library screen, display one of the following items.

- To delete tracks, tap the desired category (albums, artists, etc.), and the desired subcategory until a track list appears.
- To delete a folder, tap [Folder] and then the desired folder.

2 Tap  to display the pop-up menu and tap [Delete].

Follow the onscreen instructions.

Hint

- You can also delete tracks on a computer using the following applications. For details on operations, refer to the online help information for each application.
 - Windows: Music Center for PC, Windows Explorer
 - Mac: Content Transfer, Finder

Note

- When you delete tracks using Windows Explorer or Mac Finder, do not delete or rename the root folder (such as [MUSIC]). Otherwise, the Walkman will not recognize the content.

The contents of the Help Guide may be subject to change without notice due to updates to the product's specifications.

Related Topic

- [Library screen](#)

Digital Music Player
NW-ZX300/ZX300A

Viewing a guide to enjoy high quality sound

You can view information on enjoying content in high sound quality.

- 1 On the playback screen, tap the menu items in the following order.
 – [Settings] – [Guide to High Quality Sound] ([Sound]).

The contents of the Help Guide may be subject to change without notice due to updates to the product's specifications.

Related Topic

- [Library screen](#)
- [Sound quality setting screens](#)
- [Adjusting the sound quality settings](#)

Connecting the Walkman to an unpaired Bluetooth device for the first time

The BLUETOOTH® function enables wireless connections between devices. The devices need to support Bluetooth wireless technology. A wireless connection is possible at a range of up to 10 meters in an open area. You can use the Bluetooth function for the following operations.

- Listening to music.
Connect a Bluetooth device such as headphones or speakers. You can listen to music wirelessly.

When you connect Bluetooth devices wirelessly for the first time, the devices must be registered to each other. This registration is called “pairing”. Once the Walkman and the device are paired, you can easily connect the devices in the future.



The following instructions are a basic step-by-step procedure for connecting the Walkman and a Bluetooth device.

1 Turn on the Bluetooth function on the Bluetooth device, if necessary.

2 On the library screen, tap the menu items in the following order.
 – [Settings] – [Connect to/Add Audio Device] ([Bluetooth]).

The Bluetooth connection screen will appear.

3 Tap the Bluetooth switch () to turn on the Bluetooth function and tap [Add Device (Pairing)] ().

 will appear in the information area. A list of the connectable devices will appear on the screen ()

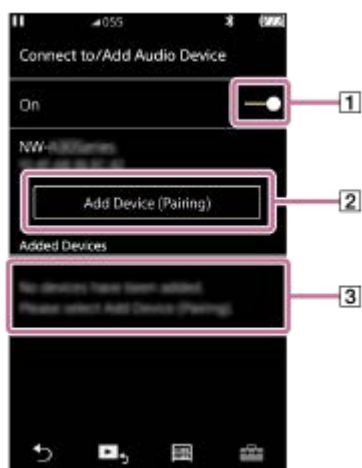

4 Tap the Bluetooth device.

If you are required to enter a passkey while pairing, check and enter the passkey for the Bluetooth device. For details on the passkey for the Bluetooth device, refer to the manual of the device. When the connection is established, [Connected] will appear in .

5 From the library screen, select and play a track.

The sound will be output from the connected Bluetooth device.

To disconnect from a paired Bluetooth device

1. While the Bluetooth device is connected, tap the menu items in the following order.

 – [Settings] – [Connect to/Add Audio Device] ([Bluetooth]).

2. Tap the name of the Bluetooth device from [Added Devices].

Hint

- You can delete registered Bluetooth device. On the list of connectable devices in [Added Devices], tap  beside the name of a Bluetooth device. Then, select [Delete Device].
- The passkey may also be called a “passcode”, “PIN code”, “PIN number”, or “password”.
- The Walkman can stay connected to a Bluetooth device until you turn off the Bluetooth function. When you are not using the Bluetooth function, turn off the Bluetooth function.

Note

- Pairing information is deleted in the following situations. Pair the devices again.
 - One or both of the devices are reset to the factory settings.
 - Pairing information is deleted from the devices, such as when the devices are repaired.
- The battery life becomes considerably shorter when the Bluetooth function is active.
- You can pair the Walkman with a maximum of 7 devices. If the number of paired devices exceeds the maximum, the Walkman will delete the oldest connected device.
- If the pairing times out before it is finished, perform the procedure again starting from the Bluetooth connection screen.
- There are some restrictions on sound output through a Bluetooth connection.
 - Even if you connect a pair of headphones to a headphone jack, sound will not be output from the headphones. Sound is output from the Bluetooth device preferentially.
- You cannot listen to played-back sound wirelessly while the USB-DAC function is active.
- If sound is interrupted or skips during a Bluetooth connection, try the following.
 - Place the Walkman and the Bluetooth device closer together.
 - Select [SBC - Connection Preferred] by tapping the following menu items.
 – [Settings] – [Audio Device Connection Settings] ([Bluetooth]) – [Wireless Playback Quality].
- A Bluetooth connection is terminated automatically in the following cases:
 - The battery of the Walkman has run out.
 - The Walkman is turned off.
- When there is an active Bluetooth connection, the sound quality settings are invalid.

The contents of the Help Guide may be subject to change without notice due to updates to the product's specifications.

Related Topic

- [Connecting the Walkman to a paired Bluetooth device](#)
- [One-touch connections with a Bluetooth device \(NFC\)](#)
- [Configuring the Bluetooth function](#)
- [Notes on the Bluetooth function](#)

Connecting the Walkman to a paired Bluetooth device

If the Walkman and a Bluetooth device have been paired before, the Bluetooth device is registered to the Walkman. You can connect the Walkman and the Bluetooth device easily.

1 Turn on the Bluetooth function on the Bluetooth device, if necessary.

2 On the library screen, tap the menu items in the following order.

 – [Settings] – [Connect to/Add Audio Device] ([Bluetooth]).

The Bluetooth connection screen will appear.

3 Tap the Bluetooth switch to turn on the Bluetooth function.

 will appear in the information area.

4 Tap the Bluetooth device.

When the connection is established, [Connected] will appear.

5 From the library screen, select and play a track.

To turn the Bluetooth function on or off

1. Tap the menu items in the following order.

 – [Settings] – [Connect to/Add Audio Device] ([Bluetooth]).

2. Tap the Bluetooth switch to turn the Bluetooth function on or off.

To confirm the information for a device:

Tap  beside the name of the Bluetooth device in the list and tap [Device Information].

To erase a registered device:

Tap  beside the name of the Bluetooth device in the list and tap [Delete Device].

Follow the onscreen instructions. The pairing information will be erased.

Hint

- A shortcut is available for the Bluetooth function. You can tap  on the [Settings] screen. The Walkman will automatically connect to the Bluetooth device that was connected the last time.
- If you connect a USB charger (not supplied), the Walkman will charge while maintaining the Bluetooth connection.
- If multiple names for a Bluetooth device are displayed, check the BD address of the Bluetooth device. For details on the BD address, refer to the manual of the Bluetooth device.
- If the Bluetooth device supports the NFC function, the Walkman and the Bluetooth device can be paired and connected by touching them together.
- The Walkman can stay connected to a Bluetooth device until you turn off the Bluetooth function. When you are not using the Bluetooth function, turn off the Bluetooth function.

Note

- The battery life becomes considerably shorter when the Bluetooth function is active.
- There are some restrictions on sound output through a Bluetooth connection.
 - Even if you connect a pair of headphones to a headphone jack, sound will not be output from the headphones. Sound is output from the Bluetooth device preferentially.
- You cannot listen to played-back sound wirelessly while the USB-DAC function is active.
- If sound is interrupted or skips during a Bluetooth connection, try the following.
 - Place the Walkman and the Bluetooth device closer together.
 - Select [SBC - Connection Preferred] by tapping the following menu items.
 -  – [Settings] – [Audio Device Connection Settings] ([Bluetooth]) – [Wireless Playback Quality].
- A Bluetooth connection is terminated automatically in the following cases:
 - The battery of the Walkman has run out.
 - The Walkman is turned off.
- When there is an active Bluetooth connection, the sound quality settings are invalid.

The contents of the Help Guide may be subject to change without notice due to updates to the product's specifications.

Related Topic

- [Connecting the Walkman to an unpaired Bluetooth device for the first time](#)
- [One-touch connections with a Bluetooth device \(NFC\)](#)
- [Configuring the Bluetooth function](#)
- [Notes on the Bluetooth function](#)

One-touch connections with a Bluetooth device (NFC)

If a Bluetooth device supports the NFC function, you can connect the Walkman and the device easily. You can simply touch the Walkman to the device to pair the devices and establish a Bluetooth connection. NFC is for close-range wireless communications.

- 1** If the Bluetooth device has an NFC switch, set the NFC switch to on.
- 2** Turn on the Walkman screen.
- 3** Touch the mark on the Walkman (1) to the mark on the Bluetooth device (2).
Hold them together until instructions appear on the screen of the Walkman.

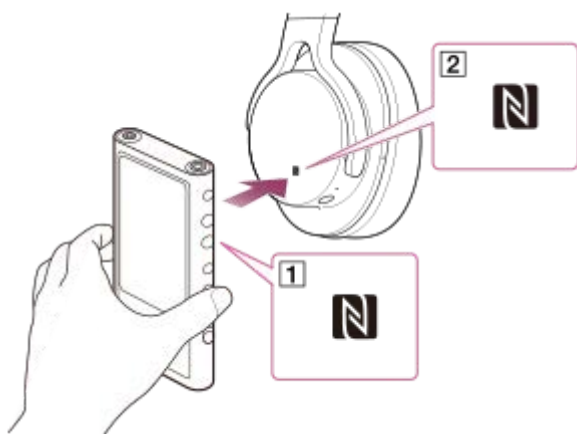

- 4** Follow the onscreen instructions on the Walkman to complete the connection.
- 5** Once the connection is established, play a track on the Walkman.

To disconnect the Walkman and the Bluetooth device using the NFC function

Turn on the Walkman screen. Then, touch the devices (1) and (2) together again to disconnect.

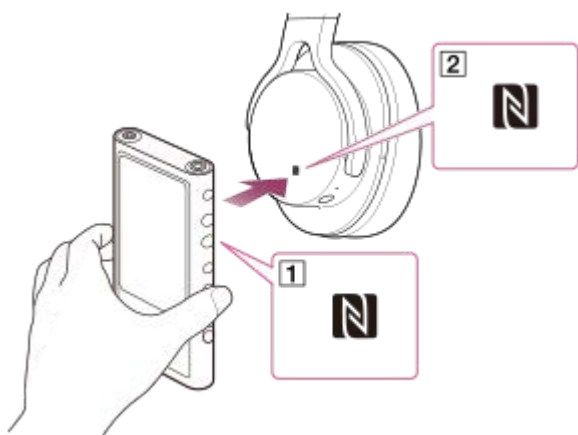

To turn off the NFC function

The NFC function is turned on as a default. If you want to turn off the NFC function, tap the menu items in the following order to remove the check mark.

 – [Settings] – [NFC] ([Bluetooth]).

Hint

- Take the following measures if the connection is poor.
 - Move the Walkman over the mark on the Bluetooth device ([2](#)).
 - If your Walkman is inside a case, take it out of the case.
 - Make sure that the NFC function is on. Tap  and then [Settings]. Confirm that there is a check mark in the check box for [NFC] ([Bluetooth]).

Note

- The battery life becomes considerably shorter when the Bluetooth function is active.
- You cannot connect the Walkman to a Bluetooth device using NFC while the following functions are active.
 - The USB-DAC function

The contents of the Help Guide may be subject to change without notice due to updates to the product's specifications.

Related Topic

- [Turning the Walkman on or off](#)
- [Configuring the Bluetooth function](#)
- [Notes on the Bluetooth function](#)

Configuring the Bluetooth function

This topic includes instructions for the following operations.

- Selecting the playback quality for Bluetooth streaming.
- Selecting the volume setting for Bluetooth streaming
- Checking Bluetooth information.

Selecting the playback quality for Bluetooth streaming

You can select the combination of codecs and preferences for Bluetooth streaming.

1. On the playback screen, tap the menu items in the following order.
 – [Settings] – [Audio Device Connection Settings] ([Bluetooth]) – [Wireless Playback Quality].
2. Tap the desired item.

Note

- The setting for [Wireless Playback Quality] will take effect starting the next time you turn on the Bluetooth function.
- The [Wireless Playback Quality] setting may not be effective depending on the settings of the Bluetooth device.

Selecting the volume setting for Bluetooth streaming

Depending on the Bluetooth device, the volume may not be adjustable using the Walkman.
In this case, try [Use Enhanced Mode].

1. On the playback screen, tap the menu items in the following order.
 – [Settings] – [Audio Device Connection Settings] ([Bluetooth]) – [Use Enhanced Mode].

Checking Bluetooth information

1. On the playback screen, tap the menu items in the following order.
 – [Settings] – [Bluetooth Information] ([Bluetooth]).
Information such as the Bluetooth version and profile will appear.

The contents of the Help Guide may be subject to change without notice due to updates to the product's specifications.

Related Topic

- [Connecting the Walkman to an unpaired Bluetooth device for the first time](#)
- [Connecting the Walkman to a paired Bluetooth device](#)
- [One-touch connections with a Bluetooth device \(NFC\)](#)

Notes on the Bluetooth function

- Depending on the Bluetooth device, network environment, and surrounding conditions, noise may be heard or the sound may be interrupted. To optimize Bluetooth communications, observe the following.
 - Place the Walkman and the Bluetooth device as close together as possible. The Bluetooth standard supports distances of up to 10 meters (32.8 feet).
 - Turn the built-in Bluetooth antenna (aerial) in the direction of the connected Bluetooth device.
 - Do not block the antenna (aerial) with a metal object such as a bag or case.
 - Do not block the antenna (aerial) with a body part such as a hand.
 - Do not block the antenna (aerial) by placing the Walkman inside a backpack or shoulder bag.
 - Do not block the antenna (aerial) by using the Walkman in a crowded place.
 - Avoid areas where electromagnetic waves are emitted. For example, near microwave ovens, mobile phones, mobile gaming devices, or wireless LAN environments.
- Due to a characteristic of Bluetooth wireless technology, the sound may lag slightly.
- Bluetooth radiation may affect the operation of electronic medical devices. Turn off the Walkman and other Bluetooth devices in the following locations.
 - in hospitals
 - near priority seats on trains
 - on airplanes
 - in places where flammable gases are present (gas stations, etc.)
 - near automatic doors
 - near fire alarms
- The Walkman supports security functions that comply with the Bluetooth standard. Sony bears no responsibility whatsoever for information leaks that occur as a result of your Bluetooth connection.
- Even if a Bluetooth device conforms to the standard, all connections and correct operations are not guaranteed.
- Depending on the Bluetooth device, it may take some time to establish a Bluetooth connection.

The contents of the Help Guide may be subject to change without notice due to updates to the product's specifications.

Related Topic

- [Parts and controls](#)

Digital Music Player
NW-ZX300/ZX300A

Enjoying music content on a computer with Walkman sound quality (USB-DAC function)

You can enjoy music content stored on a computer through the Walkman, without transferring the content to the Walkman. Because the sound quality settings of the Walkman also apply to the output sound, music content on the computer can be played with the same sound quality as the Walkman.

The following applications are compatible with the USB-DAC function. They are recommended for use with the Walkman.

- Windows: Music Center for PC
- Mac: Hi-Res Audio Player for Mac

Note

- While the USB-DAC function is turned on, the Walkman can only be used as a USB-DAC device. To use the Walkman as a music player, turn off the USB-DAC function.
- Music content cannot be transferred while the USB-DAC function is turned on.

1 Install the USB-DAC compatible application on a computer.

- Windows:
 - Music Center for PC: To install the application, access the customer support website. (<http://www.sony.net/smc4pc/>) Refer to the appropriate topic under [Related Topic].
 - Sony USB Device Driver: Access the customer support website to install Sony USB Device Driver. Follow the onscreen instructions.
- Mac:
Hi-Res Audio Player for Mac: Access the customer support website to install the application. Follow the onscreen instructions.

2 On the computer, configure the settings for USB-DAC.

For details on the settings, refer to the following information.

- Windows: Online help information for Music Center for PC
- Mac: Online help information for Hi-Res Audio Player on the customer support website.

3 On the Walkman, tap to open the library screen, and then tap .

4 When a message is displayed, tap [OK].

5 Connect the Walkman to the computer via USB.

You can adjust the volume on the [USB DAC] screen.

To go back to the music playback function

Tap  in the top left of the screen.

When a message is displayed, tap [OK].

Hint

- If you do not want the Walkman to charge from the computer, remove the check mark from [Charge this player from the connected device]. Tap the menu items in the following order.
 – [Settings] – [USB DAC Settings] ([Function Settings]) – [Charge this player from the connected device].
However, if the USB port on the computer is set to supply power constantly to the connected device, the Walkman may be charged by the computer.

Note

- You cannot listen to played-back sound wirelessly while the USB-DAC function is active.

The contents of the Help Guide may be subject to change without notice due to updates to the product's specifications.

Related Topic

- [Adjusting the sound quality settings](#)
- [Installing Music Center for PC \(Windows\)](#)
- [How to use the various screens on the Walkman](#)
- [USB-DAC screen](#)
- [Customer support website](#)

Digital Music Player
NW-ZX300/ZX300A

Adjusting the sound quality settings

The Walkman has various settings for adjusting the sound quality.

From the [Settings] menu

On the playback screen, tap  and then [Settings].

You can set the following sound settings from the menu listed under [Sound].

Direct Source (Direct)

This setting outputs the file's original sound quality directly without applying any sound effects.

Saved Sound Settings

- Save Current Settings:
You can save customized sound quality settings as your own sound presets.
- Saved Sound Settings 1/2/3:
You can retrieve preset sound quality settings.

From the [Settings] – [Sound Settings] menu

On the playback screen, tap the menu items in the following order.

 – [Settings] – [Sound Settings] ([Sound]).

You can also adjust the following settings from the sound quality setting screens.

Equalizer/Tone Control

You can customize the equalizer and tone control settings from their respective screens.

On the equalizer screen, tap [Adjust] to adjust the setting. On the tone control screen, rotate the dials to adjust the settings.

Tap  to select [Equalizer] or [Tone Control]. The selected setting will take effect.

DSEE HX

This function upscales the sound quality of audio files. The sound quality will become almost equal to that of High-Resolution Audio. The function reproduces the clear high-range sound that is often lost.

Select a sound type based on the source sound.

DC Phase Linearizer

This function adjusts low-frequency phase shifts to reproduce the audio characteristics of analog amplifiers.

Select a sound type for this setting.

Dynamic Normalizer

You can moderate the change in volume between tracks to minimize differences in volume level.

Note

- When there is an active Bluetooth connection, the sound quality settings are invalid.
- You cannot adjust [Sound Settings] in the following cases.
 - When [Direct Source (Direct)] is set to [On].

The contents of the Help Guide may be subject to change without notice due to updates to the product's specifications.

Related Topic

- [How to use the various screens on the Walkman](#)
- [Sound quality setting screens](#)

4-698-041-12(1) Copyright 2017 Sony Corporation

Using USB Mass Storage mode

When you connect the Walkman to a Windows computer, the following modes are available.

USB Mass Storage mode

- The computer uses the Walkman as a USB storage device.
- Data can be transferred between the computer and the Walkman.
- You can access the [WALKMAN] and [SD_CARD] folders directly to manage files.
- The Walkman charges via the computer.
- You cannot operate the Walkman.

USB mode

- The Walkman charges via the computer.
- You can operate the Walkman while the Walkman is connected to the computer.
- Data cannot be transferred.

This topic includes instructions for the following operations.

- Switching from USB Mass Storage mode to the USB mode
- Switching from USB mode to the USB Mass Storage mode

Switching from USB Mass Storage mode to USB mode

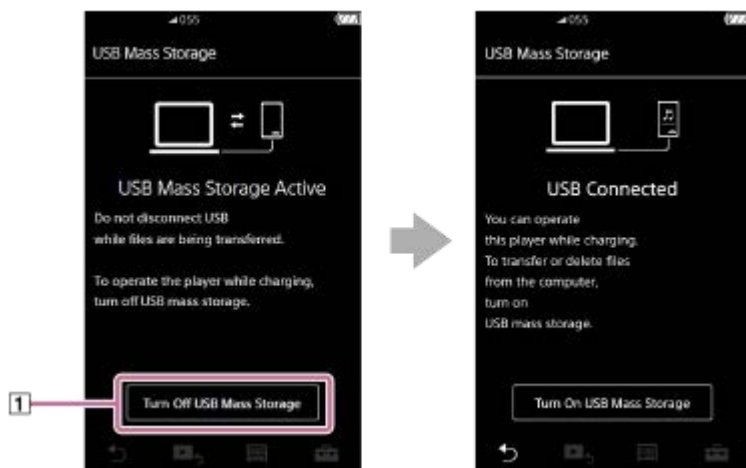

When you connect the Walkman to a computer, the Walkman enters USB Mass Storage mode.

1. Tap [Turn Off USB Mass Storage] (1).
The USB mode screen will appear.



2. Tap .
The screen will return to the previous display.

Switching from USB mode to USB Mass Storage mode

Depending on the selected function,  or [USB Connection Settings] may not appear on the Walkman display. In this case, tap  to return to the library screen for the music playback function.

1. Tap the menu items in the following order.

 – [Settings] – [Device Settings] ([Basic Settings]) – [USB Connection Settings] – [Turn On USB Mass Storage] – [OK].

Note

- Before you disable USB Mass Storage mode, we recommend that you perform [Safely Remove Hardware] on the computer.
- Do not disconnect the Walkman while transferring content between the Walkman and the computer. Doing so will damage the data.
On the computer screen, confirm that the data has finished transferring properly.

The contents of the Help Guide may be subject to change without notice due to updates to the product's specifications.

Related Topic

- [Charging the battery](#)

4-698-041-12(1) Copyright 2017 Sony Corporation

Digital Music Player
NW-ZX300/ZX300A

Restarting the Walkman

Restart the Walkman if operations become unstable or the Walkman freezes.

Restarting will not delete any data and pairing information.

However, perform the following before you restart the Walkman.

Otherwise, the data on the Walkman may be damaged.

- Disconnect the Walkman from the computer.
- Stop playback.

1 Hold down the button (1) for 8 seconds until the Walkman restarts.

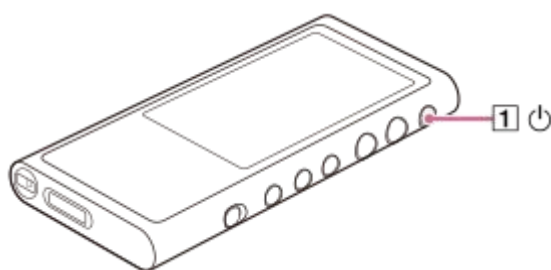

The contents of the Help Guide may be subject to change without notice due to updates to the product's specifications.

Related Topic

- [Resetting/Formatting/Initializing the Walkman](#)
- [Formatting a microSD card](#)

Resetting/Formatting/Initializing the Walkman

This topic includes instructions for the following operations.

- Resetting the Walkman.
- Formatting the memory of the Walkman.
- Rebuilding the database on the Walkman.
- Initializing the Walkman.

Confirm the details of each function. Then, select the appropriate menu item for your needs.

1 On the library screen, tap the menu items in the following order.
 – [Settings] – [Device Settings] ([Basic Settings]) – [Reset/Format].

2 Tap the operation that you want to execute.

Follow the onscreen instructions. Make sure to confirm the messages carefully.

[Reset All Settings]	This operation resets all setting parameters to the default settings. If you select this operation, the Walkman will restart automatically.
[Format System Storage]	This operation formats the internal memory of the Walkman. Note that all data (including sample data) stored on the Walkman will be deleted. Save a backup copy of important data.
[Rebuild Database]	This operation rebuilds the database on the Walkman. You can rebuild the database manually.
[Restore to Factory Configuration]	This operation initializes both the settings and internal memory. You can restore the Walkman to its default settings. All transferred data will be erased. However, the Walkman will restore its preinstalled sample content and installers as default settings. If you select this operation, the Walkman will restart automatically and the initial setup wizard will launch.

Hint

- Even if you perform [Reset All Settings], the following settings will not be changed.
 - Elapsed time of the selected track
 - Preset 1 through 3 for [Saved Sound Settings]
 - The bookmark list (1 through 10)
 - User settings for the library screen
 - Information on recently transferred content
 - Clock settings
 - Language settings

Note

- Sony does not guarantee performance if you format the memory of the Walkman using a computer.

- If you execute [Restore to Factory Configuration]/[Reset All Settings], pairing information for Bluetooth devices will be deleted from the Walkman.
- If you rebuild the database, the following information will be erased.
 - Elapsed time of the selected track
 - Playback order

The contents of the Help Guide may be subject to change without notice due to updates to the product's specifications.

Related Topic

- [Restarting the Walkman](#)
- [Formatting a microSD card](#)

4-698-041-12(1) Copyright 2017 Sony Corporation

Digital Music Player
NW-ZX300/ZX300A

Formatting a microSD card

You can format a microSD card on the Walkman.

Formatting the microSD card will delete all data stored on the card. Save a backup copy in advance. Be careful not to delete important data.

- 1 **On the library screen, tap the menu items in the following order.**
 – [Settings] – [Device Settings] ([Basic Settings]) – [Reset/Format] – [Format SD Card].

Follow the onscreen instructions. Make sure to confirm the messages carefully.

Note

- Format the microSD card on the Walkman. Otherwise, some functions of the Walkman may be limited.

The contents of the Help Guide may be subject to change without notice due to updates to the product's specifications.

Related Topic

- [Restarting the Walkman](#)
- [Resetting/Formatting/Initializing the Walkman](#)

Digital Music Player
NW-ZX300/ZX300A

Checking information on the Walkman

You can check information such as the model name and system software version.

- 1 On the library screen, tap the menu items in the following order.
 – [Settings] – [Unit Information] ([Other]).

The contents of the Help Guide may be subject to change without notice due to updates to the product's specifications.

Related Topic

- [Updating the Walkman system software](#)

Digital Music Player
NW-ZX300/ZX300A

Updating the Walkman system software

You can update the software of the Walkman.
You will receive update notices by the following methods.

- From Music Center for PC (You will receive update notices automatically.)
- From the customer support website (Access the site manually to receive update notices.)

Access the customer support website to get the latest information.
The following procedure describes how to update the software from the customer support website.
For details on how to install the program, refer to the customer support website.

- 1 Download the update program to a computer from the website.**
- 2 Connect the Walkman to the computer.**
- 3 Launch the update program.**
- 4 Follow the onscreen instructions.**

Hint

- To check the version information for the Walkman, tap the menu items in the following order.
 – [Settings] – [Unit Information] ([Other]).

The contents of the Help Guide may be subject to change without notice due to updates to the product's specifications.

Related Topic

- [Customer support website](#)
- [Restarting the Walkman](#)
- [Resetting/Formatting/Initializing the Walkman](#)
- [Checking information on the Walkman](#)



Using shortcut buttons from the quick setting panel

Shortcut buttons for some functions are available in the quick setting panel.
You can activate certain functions directly without scrolling in the [Settings] menu.

- 1 Tap  and then [Settings].
- 2 Tap the shortcut button for the desired function.



Available functions

Shortcut button	Function
	Tap the button to adjust the screen brightness. You can select a value from 1 to 100.
	Tap the button to turn the Bluetooth function on or off. When the Bluetooth function is turned on, the Walkman will automatically connect to the device that was connected the last time.
 (*1)	Tap the button to turn the Bluetooth remote control function on or off.

*1 This function is only available on models sold in certain countries or areas.

Note

- Pair the Walkman and the Bluetooth device (audio device or remote control) in advance.

Related Topic

- [Connecting the Walkman to an unpaired Bluetooth device for the first time](#)

4-698-041-12(1) Copyright 2017 Sony Corporation

Digital Music Player
NW-ZX300/ZX300A

Settings menu

You can adjust various settings from the Settings menu.
To enter the Settings menu, tap  and then [Settings].
You can select the Settings menu on the following screen.

- Library screen
- Playback screen
- Play Queue screen
- Bookmark list screen

Basic Settings

Playback Settings	Play Mode
	Playback Range
	Sleep Timer
	Artist List Display
	Display Lyrics
Output Settings	Headphone Output
	USB Output for DSD
	DSD Playback Settings
Device Settings	Beep Settings
	Disable touch panel when the HOLD switch is on
	Screen Off Timer
	Mount/Unmount SD Card
	USB Connection Settings
	Auto Power Off
	Battery Care
	Clock Settings
	Language Settings
	Reset/Format

Note

- Operating sounds ([Beep Settings]) are not output in the following situations.
 - While the Walkman is playing DSD tracks in the native format through balanced headphones. ([Play DSD in Native Format] is on.)
 - While sound is being played back via a connected Bluetooth device.
- The Walkman does not display a clock. The clock setting is used for data management.

Sound

Direct Source (Direct) (On/Off)	–
Sound Settings	Equalizer/Tone Control
	DSEE HX
	DC Phase Linearizer
	Dynamic Normalizer
Saved Sound Settings	Saved Sound Settings 1/2/3
Guide to High Quality Sound	–

Bluetooth

Connect to/Add Audio Device	On/Off
	Add Device (Pairing)
	Added Devices
Audio Device Connection Settings	Wireless Playback Quality
	Use Enhanced Mode
Remote Control Settings (*1)	On/Off
	Added Remote Control
	Add Remote Control
	Delete Remote Control
NFC (On/Off)	–
Bluetooth Information	Bluetooth Version/Device Name/Bluetooth Device Address/Profile/Version

*1 The menu item is only available on models sold in certain countries or areas.

Function Settings

USB DAC Settings	Charge this player from the connected device
------------------	--

Other

Unit Information	Model name, firmware version, total number of tracks, etc.
Certificates (*1)	Safety regulations/certification

*1 The menu item is only available on models sold in certain countries or areas.

Digital Music Player
NW-ZX300/ZX300A

Notes on handling the Walkman

Read the notes below and follow the instructions to use the Walkman safely.

- Consult a doctor if you become injured or burned from using the product.
- Contact the nearest Sony dealer or Sony Service Center if the Walkman does not operate properly.
- Observe the following precautions. Otherwise, an explosion, fire, electric shock, burns, or injury may result.
 - Do not expose the Walkman to fire.
 - Do not allow metallic objects to get inside the Walkman.
 - Do not short-circuit the terminals of the Walkman with metallic objects.
 - Do not take apart or modify the Walkman.
 - Do not use the Walkman when you see lightning or hear thunder.
 - Do not use the Walkman if it causes an uncomfortable reaction on your skin.
- Observe the following precautions. Otherwise, you may damage the casing or cause the Walkman to malfunction.
 - Do not place the Walkman in direct sunlight.
 - Do not place the Walkman in locations where the temperature is extremely high.
 - Do not leave the Walkman in direct sunlight. Do not leave the Walkman in a car with all the windows closed, especially during the summer.



- Do not place the Walkman in locations where it is exposed to vibration.
- Do not drop the Walkman from heights.
- Do not apply a strong force or shock to the Walkman.
- Do not place the Walkman in locations where there is magnetization. For example, do not place the Walkman near a magnet, speakers, or a TV.
- Do not turn on the Walkman right after you move it from a cold environment to a warm environment.
- Do not use the Walkman in damp locations, such as in a bathroom or a sauna.
- Do not place the Walkman on an unstable surface or in an inclined position.
- Do not sit down when the Walkman is inserted in your pocket.



- Do not use the Walkman in locations where it is exposed to excessive dust.
- When you store the Walkman in a bag, do not apply strong impacts to the bag. In particular, avoid storing the Walkman in a bag with the headphone cord or earphone cord wrapped around the Walkman.



- The Walkman is neither waterproof nor dustproof. Observe the following precautions. Otherwise, the Walkman may become inoperable because of short-circuited terminals or corroded metal.
 - Do not drop the Walkman into water.

- Do not use the Walkman in humid locations or during wet weather such as rain or snow.
- Do not place the Walkman against your body or clothes when you are sweating.
- Do not touch the Walkman with wet hands.



- Comply with announcements regarding the use of electronic devices when you are on an airplane.
- Heat may build up in the Walkman in the following situations, but this is not a malfunction. However, be careful because there is a risk of low-temperature burns.
 - While the battery is charging.
 - While the Walkman is playing for an extended period of time.
- Do not apply strong force to the surface of the display. Strong force may cause the following problems.
 - Distorted colors or brightness.
 - A malfunction of the display.
 - Injury from a cracked display.
- The Walkman screen is made of glass. The glass may crack if you drop the Walkman on a hard surface or if you apply strong force to the screen. Be careful when you handle the Walkman. If the glass is cracked or chipped, do not use the Walkman or touch the damaged part. Otherwise, you may get injured.
- When you use a strap, note the following.
 - The strap can get caught on objects around you. Be careful to avoid the risk of strangulation.
 - Be careful not to swing the Walkman while holding the strap. You may hit someone with the Walkman.
- Content that you record is for personal use only. Under copyright law, the content cannot be used without the permission of the copyright holder.

The contents of the Help Guide may be subject to change without notice due to updates to the product's specifications.

Digital Music Player
NW-ZX300/ZX300A

Notes on the headphones

Road safety

Do not use headphones in the following situations.

- While you are driving a car or riding a motorcycle or bicycle.
- Places where impaired hearing is dangerous. For example, on train platforms, in areas where there is vehicle traffic, or near construction sites.

Preventing hearing damage

Observe the following to protect your hearing.

- Keep the volume at a moderate level. Do not listen to audio content at high volumes for an extended period of time.
- Do not turn up the volume suddenly.

About the in-ear headphones

- When you use in-ear headphones with a high degree of adhesion, note the following. Otherwise, you may damage your ears or eardrums.
 - Do not insert the earbuds forcefully into your ears.
 - Do not remove the earbuds from your ears suddenly. When you take off the headphones, move the earbuds up and down gently.
- When you unplug the headphones from the Walkman, hold the headphones by the plug. Pulling the cord itself may damage the headphones.
- Do not sleep while you are wearing headphones. The cord may become wrapped around your neck while you are sleeping.

Consideration for others

Avoid using the Walkman in environments where sound leakage will disturb others.

The contents of the Help Guide may be subject to change without notice due to updates to the product's specifications.

Digital Music Player
NW-ZX300/ZX300A

Notes on the built-in battery

Do not touch the rechargeable battery with your bare hands if the battery is leaking. The battery liquid may cause burns or blindness. If the liquid contacts your body or clothes, wash the liquid off immediately with clean water.

The contents of the Help Guide may be subject to change without notice due to updates to the product's specifications.

Digital Music Player
NW-ZX300/ZX300A

Notes on the software

- Copyright laws prohibit the following actions without the permission of the copyright holder.
 - Reproducing the software or the manual in whole or in part.
 - Loaning out the software
- In no event will Sony be held liable for any of the following incidents that may arise out of the use of the supplied software.
 - Financial damage
 - Loss of profits
 - Claims made by third parties
- The supplied software cannot be used with devices for which it is not designated.
- Please note that the software specifications may be changed without notice for quality improvement.
- The explanations in this manual assume that you are familiar with the basic operations of a computer.
- For details on the use of computers and operating systems, refer to their respective manuals.

The contents of the Help Guide may be subject to change without notice due to updates to the product's specifications.

Digital Music Player
NW-ZX300/ZX300A

Notes on the sample data

Sample music is pre-installed on the Walkman for trial listening.
Sample data is not installed in some countries or regions.

The contents of the Help Guide may be subject to change without notice due to updates to the product's specifications.

Digital Music Player
NW-ZX300/ZX300A

General Information

- Charging time and playback time depend on the following conditions.
 - The number of times you have charged the battery
 - Operating temperature
- When the battery is sufficiently charged but the battery life has dropped to about half of its normal span, the battery may be worn out.
- A lithium-ion rechargeable battery is built into the Walkman. When you store the Walkman for long periods of time, check the following to prevent the deterioration of the built-in battery.
 - Store the Walkman at temperatures from 5 °C to 35°C (41 °F to 95 °F).
 - To prevent deterioration of the battery, charge the battery at least once every 6 months.



- When you use the Walkman in a cold location, the onscreen display may become dark or may not respond quickly. However, these are not malfunctions.
- You feel mild tingling against your ears particularly in dry air conditions. This is a result of static electricity accumulated in the body. This effect can be minimized by wearing clothes made from natural materials.
- Sony is not responsible for user data even if the following problems occur due to defects in the Walkman or a computer.
 - Recording or downloading of data is incomplete.
 - Data (such as music) is damaged or deleted.

The contents of the Help Guide may be subject to change without notice due to updates to the product's specifications.

Digital Music Player
NW-ZX300/ZX300A

Maintenance

- Clean the Walkman with a soft cloth, such as a cleaning cloth for eyeglasses.
- To clean a Walkman that has gotten very dirty, use a cloth slightly moistened with a mild detergent solution. Be careful not to get water inside the Walkman.
- Do not clean with solvents such as alcohol, naphtha, or paint thinner. These solvents may damage the surface of the Walkman.
- Clean the headphone plug occasionally with a soft dry cloth. Noise or sound skipping may occur if the plug is dirty.

The contents of the Help Guide may be subject to change without notice due to updates to the product's specifications.

Digital Music Player
NW-ZX300/ZX300A

Customer support website

Visit the customer support website in your country or region in the following situations.

- When you have a question about the Walkman.
- When you have an issue with the Walkman.
- When you want information on compatible items.

For customers in the US:

<http://www.sony.com/walkmansupport>

For customers in Canada:

English

<http://www.sony.ca/ElectronicsSupport/>

French

<http://www.sony.ca/ElectronicsSupport/>

For customers in Latin America:

<http://www.sony-latin.com/index.crp>

For customers in Europe:

<http://www.sony.eu/dna/wm/>

For customers in Asia/Oceania/the Middle East/Africa:

English

<http://www.sony-asia.com/support>

Korean

<https://scs.sony.co.kr/scs/handler/ProductSupport>

Simplified Chinese

<https://service.sony.com.cn>

Traditional Chinese

<http://service.sony.com.tw/>

For customers who purchased the overseas models:

<http://www.sony.co.jp/overseas/support/>

The contents of the Help Guide may be subject to change without notice due to updates to the product's specifications.

4-698-041-12(1) Copyright 2017 Sony Corporation

Specifications

Display

Size/Resolution	3.1-inch (7.8 cm), WVGA (800 × 480 Pixels)
Panel type	TFT color display with white LED-backlight Capacitive touch screen

Interface

USB	Hi-Speed USB (USB 2.0 compliant)
Headphone	Stereo Mini-jack, Balanced Standard-jack
WM-PORT	WM-PORT (multiple connecting terminal): 22 pins
External memory	microSD microSDHC microSDXC

Bluetooth

Version	Ver. 4.2
Frequency band	2.4 GHz band (2.4000 GHz - 2.4835 GHz)
Modulation method	FHSS
Compatible Bluetooth profiles (*1)	A2DP (Advanced Audio Distribution Profile) AVRCP (Audio Video Remote Control Profile)
Supported Codec (*2)	SBC (*3), LDAC, aptX, aptX HD

*1 Bluetooth profiles are standardized according to the purpose of the Bluetooth device.

*2 Codec indicates the audio signal compression and conversion format.

*3 SBC stands for Subband Codec.

NFC

NFC	Active type (for reader and writer)
-----	-------------------------------------

Headphone Out (Stereo Mini-jack)

Frequency response	20 Hz to 40,000 Hz (when playing data file, single signal measurement)
--------------------	---

Headphone Out (Balanced Standard-jack)

Frequency response	20 Hz to 40,000 Hz (when playing data file, single signal measurement)
--------------------	---

General

Power Source	Built-in Rechargeable lithium-ion Battery USB power (from a computer via a USB connector of the player)
Charging Time	USB-based charging Approx. 5.5 hours
Operating temperature	5 °C to 35 °C (41 °F to 95 °F)
Dimensions	w/h/d, projecting parts not included Approx. 57.3 mm × 119.5 mm × 14.8 mm (2.26 inches × 4.71 inches × 0.59 inches)
	w/h/d Approx. 57.7 mm × 120.4 mm × 14.9 mm (2.28 inches × 4.75 inches × 0.59 inches)
Mass	Approx. 157 g (5.54 oz)

Capacity

NW-ZX300	64 GB
NW-ZX300A	16 GB

Actual available memory for other contents

NW-ZX300	Approx. 55.93 GB=60,055,519,232 byte
NW-ZX300A	Approx. 12.26 GB=13,164,150,784 byte

Note

- Available capacity may vary. A portion of the memory is used for data management functions.

Battery life

Music (Approx.)

	Stereo Mini-jack	Balanced Standard-jack
MP3 (128 kbps)	30 hours	25 hours
AAC (256 kbps)	27 hours	23 hours
FLAC (96 kHz/24 bit)	26 hours	23 hours
FLAC (192 kHz/24 bit)	23 hours	20 hours
DSD (2.8224 MHz/1 bit)	19 hours	13 hours
DSD (5.6448 MHz/1 bit)	15 hours	12 hours
DSD (11.2896 MHz/1 bit)	13 hours	10 hours

Bluetooth (Approx.)

MP3 (128 kbps)	SBC - Connection Preferred: 25 hours
FLAC (96 kHz/24 bit)	LDAC - Connection Preferred (Auto): 14 hours

Note

- The values shown in this topic are the approximate battery life when content is played continuously at the default settings.
- Even if the player is turned off for an extended period, a small amount of battery power is still consumed.
- Battery life may vary depending on volume setting, conditions of use and ambient temperature.
- The battery is consumed considerably when the screen is on.
- The battery life may become about 55 % shorter when some of the sound quality settings are active.
- A Bluetooth connection will shorten the battery life by up to 65 % depending on the following conditions.
 - Format of the content.
 - Settings of the connected device.

The contents of the Help Guide may be subject to change without notice due to updates to the product's specifications.

Maximum recordable number of songs

Music (Approx.)

	NW-ZX300 (64 GB)	NW-ZX300A (16 GB)
MP3 (128 kbps)	15,000 songs	3,300 songs
AAC (256 kbps)	7,600 songs	1,600 songs
FLAC (44.1 kHz/16 bit)	1,300 songs	300 songs
FLAC (96 kHz/24 bit)	420 songs	90 songs
FLAC (192 kHz/24 bit)	210 songs	40 songs
DSD (2.8224 MHz/1 bit)	340 songs	70 songs
DSD (5.6448 MHz/1 bit)	170 songs	30 songs
DSD (11.2896 MHz/1 bit)	80 songs	10 songs

Note

- The approximate numbers are based on 4 minute a song.
- This product is confirmed to operate normally with up to a total of 20,000 tracks stored in the main memory and on the microSD card.

The contents of the Help Guide may be subject to change without notice due to updates to the product's specifications.

Digital Music Player
NW-ZX300/ZX300A

Supported formats

Music

MP3 (.mp3)

32 kbps - 320 kbps (Supports variable bit rate (VBR)) / 32 kHz, 44.1 kHz, 48 kHz

WMA (.wma)

32 kbps - 192 kbps (Supports variable bit rate (VBR)) / 44.1 kHz

FLAC (.flac)

16 bit, 24 bit / 8 kHz - 384 kHz

WAV (.wav)

16 bit, 24 bit, 32 bit (Float/Integer) / 8 kHz - 384 kHz

AAC (.mp4, .m4a, .3gp)

16 kbps - 320 kbps / 8 kHz - 48 kHz

HE-AAC (.mp4, .m4a, .3gp)

32 kbps - 144 kbps / 8 kHz - 48 kHz

Apple Lossless (.mp4, .m4a)

16 bit, 24 bit / 8 kHz - 384 kHz

AIFF (.aif, .aiff, .afc, .aifc)

16 bit, 24 bit, 32 bit (Float/Integer) / 8 kHz - 384 kHz

DSD (.dsf, .dff)

1 bit / 2.8224 MHz, 5.6448 MHz, 11.2896 MHz

APE (.ape)

8 bit, 16 bit, 24 bit / 8 kHz - 192 kHz (Fast, Normal, High)

MQA (.mqa.flac)

Supported

Note

- Sampling frequency may not correspond to all encoders.
- Copyright protected files cannot be played back.
- Non-standard bit rates or non-guaranteed bit rates are included depending on the Sampling frequency.
- Files that are 4 GB (2 GB for APE) or larger cannot be played back.
- This product recognizes audio sources exceeding CD quality (44.1 kHz/16 bit quantization) and DAT quality (48 kHz/16 bit quantization) as High-Resolution Audio.
The "HR" symbol is displayed for High-Resolution Audio sources.

The contents of the Help Guide may be subject to change without notice due to updates to the product's specifications.

4-698-041-12(1) Copyright 2017 Sony Corporation

Digital Music Player
NW-ZX300/ZX300A

System requirements

Supported OS

- Windows® 10
- Windows® 8.1
- Windows® 7
- macOS™ v10.8 - 10.12

Note

- You need an Internet connection to download computer applications.
- We do not guarantee operation for all computers.

The contents of the Help Guide may be subject to change without notice due to updates to the product's specifications.

Digital Music Player
NW-ZX300/ZX300A

The built-in rechargeable battery becomes depleted quickly even after the Walkman is fully charged.

Limit the battery consumption to check if the battery condition improves.

If the battery life becomes half as short as normal, consider replacing the battery.

The battery life depends on the conditions of use, settings, and ambient temperature.

Furthermore, the following operations will deplete the battery more quickly than continuous use of the Walkman.

- Turning the Walkman on or off frequently.
- Changing the Walkman settings frequently.
- Charging and discharging the battery repeatedly.

This will gradually decrease the capacity of the battery. As a result, the battery may become depleted quickly even after it is fully charged.

To replace the battery, contact the nearest Sony dealer or Sony Service Center.

The contents of the Help Guide may be subject to change without notice due to updates to the product's specifications.

Digital Music Player
NW-ZX300/ZX300A

What is the battery lifespan?

The built-in rechargeable battery can be charged approximately 500 times.

The battery can be charged approximately 500 times on average.

However, the battery lifespan depends on the temperature and usage environment.

When the life of a fully charged battery becomes half as short as normal, consider replacing the battery.

To replace the battery, contact the nearest Sony dealer or Sony Service Center.

Do not replace the battery yourself. The battery is built into the Walkman. Battery replacement requires professional knowledge and skills.

The contents of the Help Guide may be subject to change without notice due to updates to the product's specifications.

Digital Music Player
NW-ZX300/ZX300A

Can I replace the built-in rechargeable battery myself?

Do not replace the battery yourself.

The battery is built into the Walkman. Battery replacement requires professional knowledge and skills. Do not replace the battery yourself.

The Walkman uses a designated rechargeable battery. Commercially available batteries cannot be used. To replace the battery, contact the nearest Sony dealer or Sony Service Center.

For your information

The battery performance deteriorates due to the following factors.

- The number of times you charge or discharge the battery.
- How long the battery is used.
- Usage environment.

The battery life can be an indicator for replacement.

When the life of a fully charged battery becomes half as short as normal, the battery should be replaced.

The battery can be charged approximately 500 times on average.

The contents of the Help Guide may be subject to change without notice due to updates to the product's specifications.

Digital Music Player
NW-ZX300/ZX300A

The computer does not recognize the microSD card in the Walkman.

Disconnect the Walkman from the computer, and then try the following measures.

The computer will not recognize the microSD card in the following cases.

- The microSD card is not inserted firmly enough.
 - You inserted the microSD card after you connected the Walkman to the computer.
1. Select [Mount/Unmount SD Card] on the Walkman.
Tap the menu items in the following order.
 – [Settings] – [Device Settings] (Basic Settings) – [Mount/Unmount SD Card].
 2. Remove the microSD card from the Walkman. Then, reinsert the microSD card firmly and securely.
 3. Connect the Walkman to the computer.

The contents of the Help Guide may be subject to change without notice due to updates to the product's specifications.

Digital Music Player
NW-ZX300/ZX300A

The Walkman does not recognize a microSD card.

Try the following measures.

Make sure that the microSD card is inserted firmly and securely.

Select [Mount/Unmount SD Card] on the Walkman before you remove the microSD card. Then, reinsert the microSD card firmly into the Walkman.

Make sure that the contact pins of the microSD card are clean.

Clean the contact pins of the microSD card with a dry cloth or a cotton bud. Then, reinsert the microSD card firmly.

Make sure that the microSD card is in a format that the Walkman can recognize.

Copy all the data on the microSD card onto a computer first. Then, format the microSD card on the Walkman. Use the Walkman to format the microSD card. Sony does not guarantee the operation of microSD cards that have been formatted on other devices such as computers.

The contents of the Help Guide may be subject to change without notice due to updates to the product's specifications.

Digital Music Player
NW-ZX300/ZX300A

A track is duplicated on the Walkman.

A track may be duplicated on the Walkman if you transfer the same track using different transfer methods.

A track may be duplicated for the following reasons.

- The same track is transferred repeatedly in different formats.
- The same track is transferred repeatedly with different track information.
- The same track is transferred repeatedly with different transfer methods (the same track is transferred to different storage folders).

You can delete unnecessary tracks from the Walkman.

Note on using microSD cards

If you are using the Walkman that supports microSD card, you may have transferred the same track to both the Walkman and the microSD card.

Check the tracks on the Walkman and the microSD card to confirm that there are no duplicate tracks.

How to delete tracks from the Walkman

To delete tracks on the Walkman

1. On the library screen, tap the desired category (album, artist, etc.) and subcategory until the track list appears.
2. Tap  next to the track you want to delete, and then tap [Delete].

To delete tracks using Windows Explorer

1. Connect the Walkman to the computer, and open Windows Explorer.
2. Open the folder for the Walkman. Then, select the duplicate track in the [MUSIC] folder and delete the track.

Hint

- Disable the automatic track transfer functions in music management applications such as the [Sync] function in Windows Media Player.
If the function is enabled, tracks may be transferred to the [MUSIC] folder on the Walkman every time you connect the Walkman to the computer.

The contents of the Help Guide may be subject to change without notice due to updates to the product's specifications.

Digital Music Player
NW-ZX300/ZX300A

The Walkman cannot play transferred content.

Try the following measures.

[Cannot play; file format is not supported.] appears on the screen.

The Walkman only plays content in compatible formats (bitrate, etc.).

For details on supported formats, refer to the specifications section of the [Help Guide] or the model website.

Make sure that the Walkman supports the format of the content you are trying to play.

When you cannot find the transferred content on the Walkman.

- Content may be transferred to folders or locations that the Walkman cannot access. This may happen when you drag-and-drop the content using Windows Explorer or Mac Finder. Transfer the content to the appropriate folder or location.
- When you transfer audio content in the MP4 format, drag-and-drop the content into the [MUSIC] folder on the Walkman.
- If you have performed one of the following operations on a computer, the content may not be recognized on the Walkman. In this case, change the file name or file location back to the original name or location.
 - You changed the file name of content on the Walkman.
 - You changed the location of content on the Walkman.
- If you formatted the memory of the Walkman in Windows Explorer or Mac Finder, format the memory using the menu on the Walkman.

The contents of the Help Guide may be subject to change without notice due to updates to the product's specifications.

Digital Music Player
NW-ZX300/ZX300A

**You have spilled liquid (water, coffee, etc.) on the Walkman.
You have washed the Walkman in a washing machine.**

Contact the nearest Sony dealer or Sony Service Center.

Liquid may get inside the Walkman in the situations listed above.
Stop using the Walkman immediately. Then, contact the nearest Sony dealer or Sony Service Center.

The contents of the Help Guide may be subject to change without notice due to updates to the product's specifications.

Digital Music Player
NW-ZX300/ZX300A

The Walkman does not work properly.

If one of the following situations occurs, restart the Walkman.

- The Walkman does not respond to operations.
- The Walkman screen freezes.

Adequately charge the Walkman. Then, hold down the  (power) button for 8 seconds until the Walkman restarts.

The contents of the Help Guide may be subject to change without notice due to updates to the product's specifications.