

# Cordless Stereo Headphone System

## Operating Instructions

### MDR-IF125RK

Sony Corporation © 1996 Printed in Korea

## WARNING

To prevent fire or shock hazard, do not expose the unit to rain or moisture.

To avoid electrical shock, do not open the cabinet. Refer servicing to qualified personnel only.

### WARNING

You are cautioned that any changes or modifications not expressly approved in this manual could void your authority to operate this equipment.

### Owner's Record

The model number is located on the top of the transmitter and the inner side of the headband. The serial number is located at the bottom of the transmitter and inside the battery compartment of the headband. Record these numbers in the spaces provided below. Refer to them whenever you call upon your Sony dealer regarding this product.

Model No. MDR-IF125RK  
 Transmitter TMR-IF125R  
 Headphones MDR-IF120  
 Serial No.  
 Transmitter \_\_\_\_\_  
 Headphones \_\_\_\_\_

## Welcome!

Thank you for purchasing the Sony MDR-IF125RK Cordless Stereo Headphone System. Before operating the unit, please read this manual thoroughly and retain it for future reference. Some features are:

- Cordless system that allows you to listen to a program free from the restriction of a cord.
- Broad horizontal listening area that gives you superb sound virtually anywhere in the room.
- Self-adjusting headband for fitting your head perfectly.
- The VOL control adjusts the volume level of both channels.
- The supplied rechargeable battery can be used to power the headphones.

## About the infrared rays communication

The illustration below shows the approximate area covered by the infrared rays emitted from the transmitter.

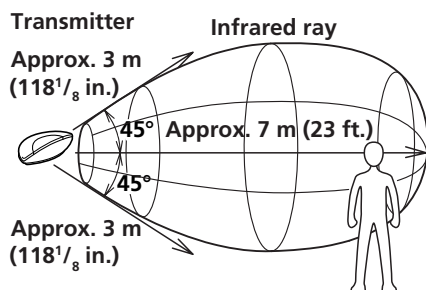

### Notes

- This system utilizes infrared rays for communication so noise (hissing) can be heard in the headphones as you move farther away from the transmitter. The sound will also cutoff and noise occur if the infrared rays are blocked. These are characteristics of infrared ray communication and do not indicate an equipment breakdown.
- The infrared rays will not penetrate walls or opaque glass, therefore, be sure to stay within sight of the transmitter.
- When you use the headphones inside the area illustrated in the diagram, the transmitter can be placed in the front, behind or by the side of the listener.
- The sound you hear varies according to your position and the transmitter position. Try finding a position which yields the best sound.

## Unpacking

Check that you have the following items:

- Transmitter **TMR-IF125R**
- AC power adaptor
- Connecting cord (phono plugs ↔ stereo mini plug)
- Ni-Cd Rechargeable battery NC-AA (HJ)
- Headphones **MDR-IF120**

- 2 If your AC power adaptor is equipped with a voltage selector, before connecting the AC power adaptor to an AC outlet, set it to the operating voltage in your area with a screw driver.

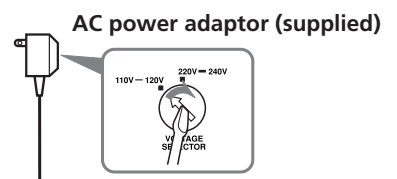

- 3 Connect the transmitter to a power source.

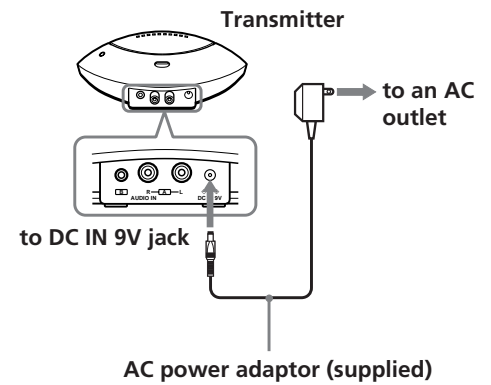

### Notes

- Do not connect to the AUDIO IN A jacks and B jack at the same time. If you do so, the audio signals may be mixed.
- Use only the supplied AC power adaptor. Do not use any other AC power adaptor.



- If the plug of the AC power adaptor does not fit in the AC outlet, use the supplied AC plug adaptor.
- When you connect the connecting cord directly to an earphone jack, the audio signal will not be output through the right channel. In such a case, use the separately sold PC-236HG plug adaptor.

\* WALKMAN is a registered trademark of Sony Corporation.

## Setting up the transmitter

- 1 Connect the transmitter to audio/video equipment. Select one of the hookups below depending on the jack type:

- a To connect to LINE OUT or REC OUT jacks

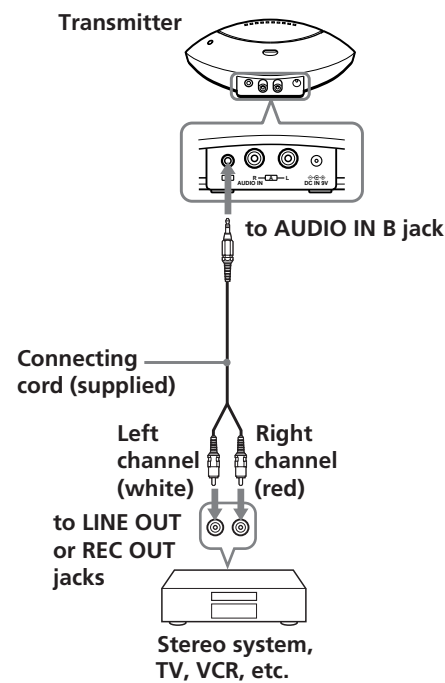

- b To connect to a headphones jack

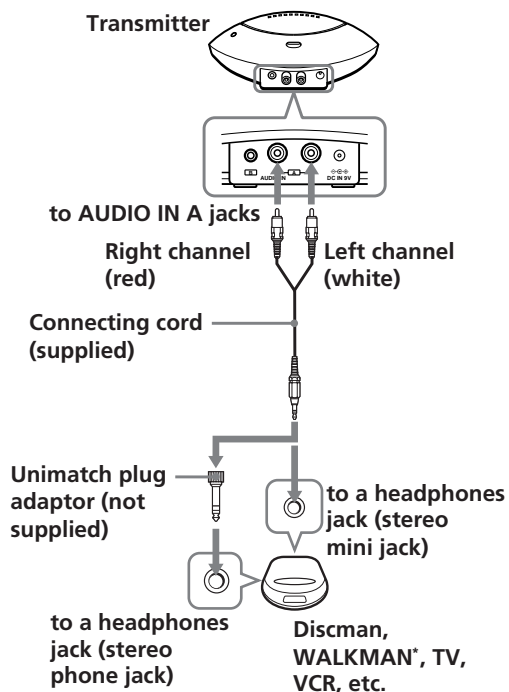

## Charging the rechargeable battery

The headphones are powered by a rechargeable battery (supplied) or a dry cell battery (not supplied). Charge the rechargeable battery before use.

- 1 Check that the transmitter power is off.

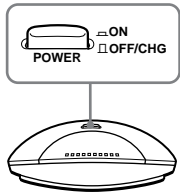

- 2 Open the battery charger lid on the transmitter.

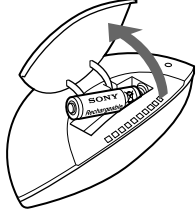

- 3 Insert the supplied rechargeable battery NC-AA (HJ), making sure to match battery polarity with the ⊕ and ⊖ marks on the charger case. The CHARGE indicator then lights up and charging starts.

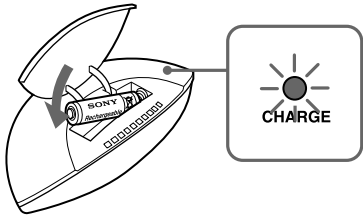

- 4 Close the battery charger lid on the transmitter.

### Charging time and battery life

About 24 hours is required to fully charge the rechargeable battery. Once fully charged, the battery provides about 35 hours of operation. One hour charging of the rechargeable battery enables about 1 hours and 30 minutes of operation.

### Notes

- This system is designed to charge only the supplied rechargeable battery for safety. This system cannot charge other batteries even if they have the same shape.
- Since little electric current is used for charging, there is no need to worry about overcharging.
- As this system is not affected by the memory effect of the Ni-Cd battery, recharging the supplied battery before it is completely discharged is not a problem.
- When the transmitter power is turned on, the battery charger does not operate.

### When to recharge the battery

Recharge the supplied battery when the POWER indicator on headphones dims, and hissing or noise occurs. If the POWER indicator dims even after full charging, the battery is completely dead. To purchase a new rechargeable battery, consult your nearest Sony dealer.

## Setting up the headphones

- 1 Open the battery compartment lid on the left inner side of the headband.

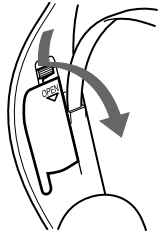

- 2 Insert the supplied rechargeable battery NC-AA (HJ) by matching the ⊕ and ⊖ on the battery to the ⊕ and ⊖ in the battery compartment. Make sure that the battery is charged.



- 3 Close the battery compartment lid.

### Using a dry cell battery

Insert the dry cell battery into the headphone battery compartment the same as when inserting the rechargeable battery.

### Battery life

Battery	Approx. hours
Sony alkaline battery LR6/AM3 (N)	100
Sony battery R6P/SUM-3 (NS)	50

### When to replace the battery

Replace the battery with a new one when the POWER indicator on the headphones dims, and a hissing noise increases.

## Listening to a program

- 1 Turn on the audio/video equipment connected to the transmitter.
- 2 Turn on the transmitter. The infrared emitters light up.

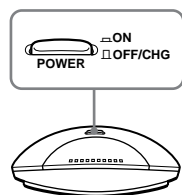

- 3 Turn on the power of the headphones. The power indicator lights in red.

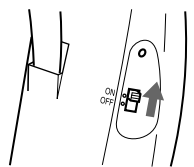

- 4 Put on the headphones.



- 5 Adjust the volume.

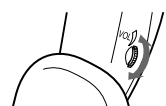

### Mute function

If a hissing noise is heard when the infrared rays are obstructed, or the headphones are used outside of the effective range (see "About the infrared rays communication"), the mute function will be activated and the sound will not be heard from the headphones. To restore the sound, move nearer toward the transmitter or remove the obstruction.

### After listening to a program

Take the headphones off before turning off the headphones and the transmitter. Otherwise you may hear some noise when the infrared rays are suddenly cut off.

### Note

The infrared emitters light up when the transmitter is turned on. The brightness of the emitters may not be uniform, however, this is not a malfunction.

## Precautions

- Before operating the system, check that the operating voltage of your system is identical with the voltage of your local power supply.
- The CE mark on the unit is valid only for products marketed in the European Union.
- When the headphones is not to be used for a long period of time, remove the battery to avoid damage caused by battery leakage and subsequent corrosion.
- When the transmitter is not to be used for a long period of time, disconnect the AC power adaptor from the AC outlet holding the plug. Do not pull on the cord.
- Do not leave the cordless stereo headphones system in a location subject to direct sunlight, heat or moisture.

### Notes on headphones Preventing hearing damage

Avoid using headphones at high volume. Hearing experts advise against continuous, loud and extended play. If you experience a ringing in your ears, reduce the volume or discontinue use.

### Caring for others

Keep the volume at a moderate level. This will allow you to hear outside sounds and to be considerate to the people around you.

If you have any questions or problems concerning the system that are not covered in this manual, please consult the nearest Sony dealer.

Be sure to bring the headphones and the transmitter to the Sony dealer when requiring repair work.

## Replacing the Ear Pads

When the ear pads become dirty or damaged, consult your nearest Sony dealer and replace them as illustrated below.

Remove the old ear pad by pulling it out.

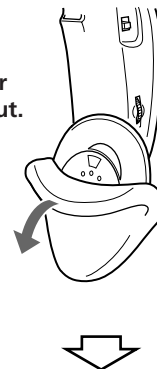

Place the new ear pad on the housing as illustrated.

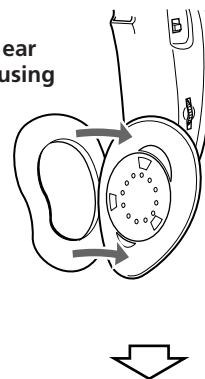

Make sure that the ear pad is securely replaced.

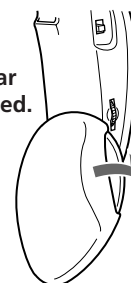

## Troubleshooting

### No sound/Muffled sound

- ➔ Turn on the transmitter and the headphones first, then put on the headphones.
- ➔ Check the connection of the audio/video equipment or the AC power adaptor.
- ➔ Check that the audio/video equipment is turned on.
- ➔ Turn up the volume on the connected audio/video equipment, if the transmitter is connected to the headphones jack. (Around level 5 or 6 on the volume control should be appropriate.)
- ➔ The mute function is activated.
  - Check if there is any object between the transmitter and the headphones.
  - Use the headphones near the transmitter.
  - Change the position and angle of the transmitter.
- ➔ The POWER indicator on the headphones dims.
  - Recharge the supplied battery. If there is no sign of improvement, please consult your nearest Sony dealer.
  - Replace the battery of the headphones.

### Distortion

- ➔ If the transmitter is connected to the headphones jack, turn down the volume of the connected audio/video equipment. (Around level 5 or 6 on the volume control should be appropriate.)
- ➔ Recharge the supplied battery.
- ➔ Replace the battery of the headphones.

### Loud background noise

- ➔ Move closer to the transmitter. As you move away from the transmitter, more noise is likely to be heard. This is inherent to infrared ray communication and does not mean that there is a problem with the unit itself.
- ➔ Check that there is no object between the transmitter and the headphones.
- ➔ Check that the infrared sensors are not covered with your hands or hair.
- ➔ Change the position or angle of the transmitter.
  - The headphones are used by a window where the sunlight is too strong.
    - ➔ Draw the curtains/blind to shut out the direct sunlight, or use the headphones away from the sunlight.
- ➔ If the transmitter is connected to the headphones jack, turn up the volume of the connected audio/video equipment. (Around level 5 or 6 on the volume control should be appropriate.)
- ➔ Recharge the supplied battery.
- ➔ Replace the battery of the headphones.

## Specifications

### General

Modulation system	Frequency modulation
Carrier frequency	Right 2.8 MHz Left 2.3 MHz
Frequency response	18 – 22,000 Hz

### Transmitter TMR-IF125R

Power source DC IN 9V jack accepts power supplied from the AC power adaptor for use on the following voltages:

Where purchased	Operating voltage
U.S.A./Canada	120 V AC, 60 Hz
U.K.	230 – 240 V AC, 50 Hz
European countries	220 – 230V AC, 50 Hz
Other countries	220 – 230 V AC, 50/60 Hz or 120 V AC, 60 Hz
Japan (Except for Japanese domestic model)	110 – 120 V/220 – 240 V AC, 50/60 Hz

Audio input	Phono jacks/stereo mini jack
Dimensions	Approx. 152 × 40 × 72 mm (6 × 1 1/2 × 2 3/4 in.) (w/h/d)
Mass	Approx. 88 g (3.1 oz.)

### Headphones MDR-IF120

Power source	DC 1.5 V, 1 × R6 (size AA) battery
Mass	Approx. 130 g (4.6 oz.) including battery

### Optional accessories

Plug adaptor	PC-236HG (stereo mini jack ↔ monaural mini plug)
	PC-234HG (stereo mini jack ↔ stereo phone plug)
Connecting cords	RK-C510HG/RK-C515HG/RK-C520HG (phono plug × 2 ↔ phono plug × 2)
	RK-G136HG (stereo mini plug ↔ stereo mini plug)
	RK-G129HG (stereo mini plug ↔ phono plug × 2)

Design and specifications are subject to change without notice.