

# Wi-Fi Connection/ One-touch (NFC) Guide

## Uputstvo za Wi-Fi povezivanje/povezivanje jednim dodirrom (NFC)

\* NFC: Near Field Communication



**GB** To send photos/videos from the camera to a computer via Wi-Fi: see A-1  
**SRB** Za slanje fotografija/video zapisa sa fotoaparata na računar preko Wi-Fi mreže: pogledati A-1



**GB** To send photos/videos from the camera to a smartphone or tablet: see B-1  
**SRB** Za slanje fotografija/video zapisa sa fotoaparata na pametni telefon ili tablet uređaj: pogledati B-1



### A-1

**GB** Install the latest software on to your computer.  
**SRB** Instalirajte najnoviji softver na vaš računar.



Windows

<http://www.sony.net/pm/>

Mac **Wireless Auto Import\***

<http://www.sony.co.jp/imsoft/Mac/>

**GB** \*Select [Wireless Auto Import].

**SRB** \*Izaberite [Wireless Auto Import].

### A-2

**GB** Select procedure **a** or **b** to connect access point. For more information, refer to the instruction manual of the access point, or contact the person who set up the access point.

**SRB** Izaberite postupak **a** ili **b** za povezivanje pristupne tačke. Za više informacija, pogledajte uputstvo za upotrebu pristupne tačke, ili kontaktirajte osobu koja je podesila pristupnu tačku.

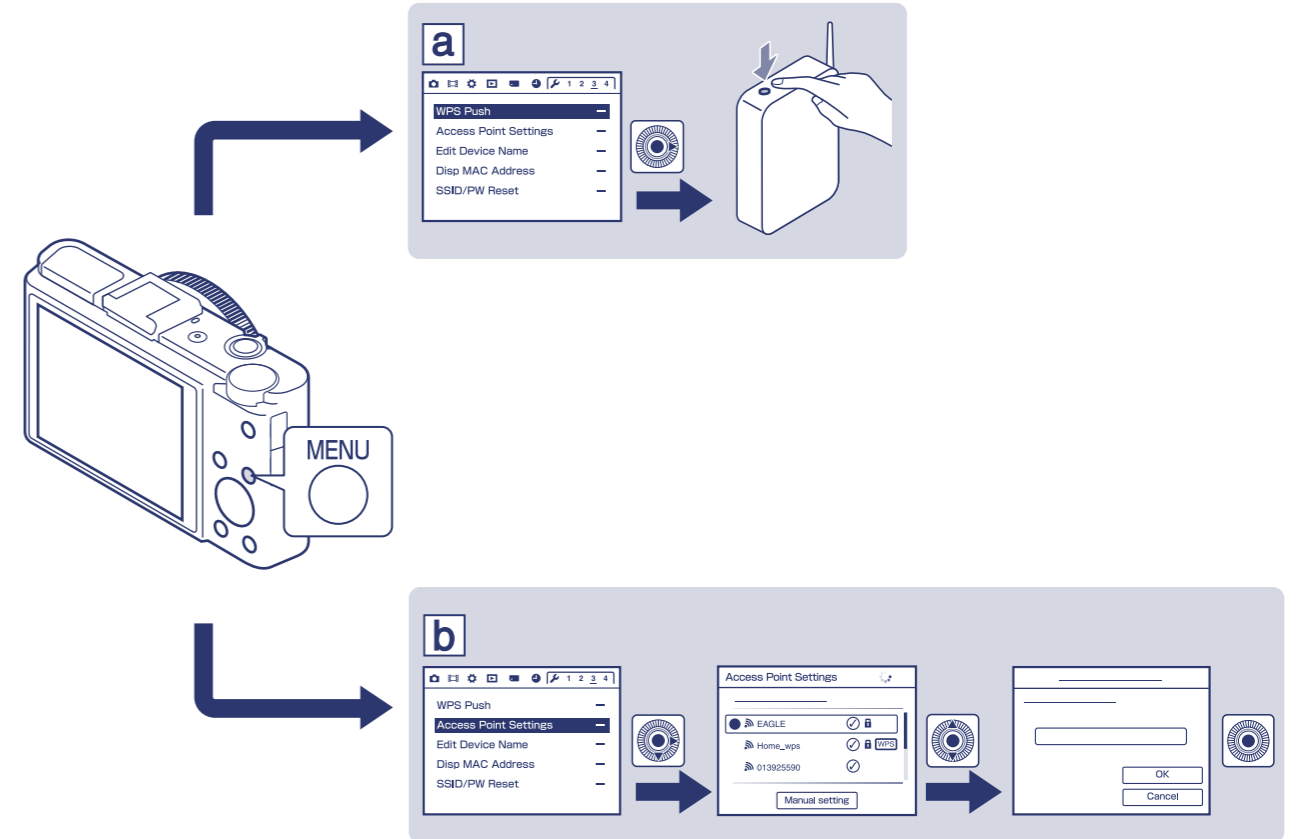

### A-3

**GB** Start sending images from the camera to the computer. Previously sent images are not re-sent.

**SRB** Započnite sa slanjem slika sa fotoaparata na računar. Ranije poslate fotografije se neće ponovo poslati.

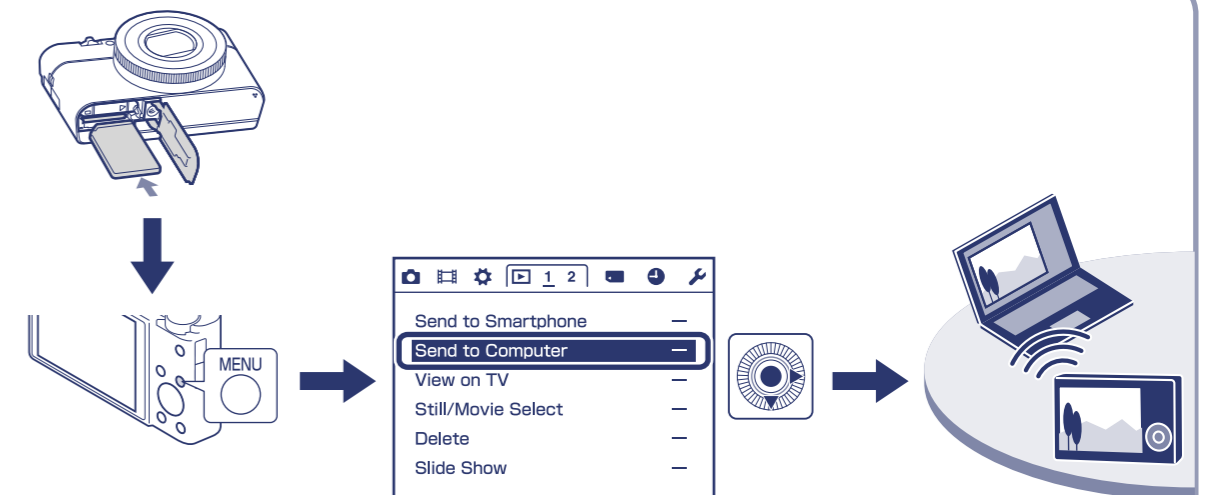

# B-1

**GB** Install the latest version of PlayMemories **Mobile** app on your smartphone. See WEBSITE\* for more information.

**SRB** Instalirajte najnoviju verziju aplikacije PlayMemories **Mobile** na vaš pametni telefon. Pogledajte veb sajt\* za više informacija.

\*<http://www.sony.net/pmm/>



\*Using One-touch functions (NFC), Android 4.0 ~

\*Upotreba funkcija povezivanja jednim dodirrom (NFC), Android 4.0 ~



\*One-touch functions (NFC) are not available

\*Funkcije povezivanja jednim dodirrom (NFC) nisu dostupne

**GB** May not be able to access Google play/App Store in some countries/regions. No guaranteed to work on all Smartphones/Tablet computers.

**SRB** Pristup servisima Google play/App Store možda neće biti moguć u nekim državama/regijama. Nije garantovan rad sa svim pametnim telefonima/tablet računarima.

# B-2

## Android/iOS not supporting NFC / Android/iOS koji ne podržava NFC

**GB** Select an image on the camera to be sent, then the SSID and password will be displayed. Select the correct SSID on your smartphone, then input the password.

**SRB** Izaberite fotografiju na fotoaparatu koju želite da pošaljete. Prikazaće se SSID i lozinka. Izaberite tačan SSID na vašem pametnom telefonu, a zatim unesite lozinku.

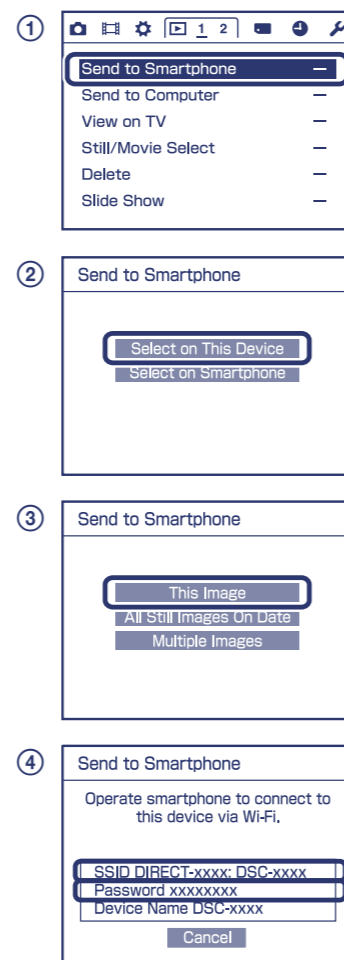

### Android

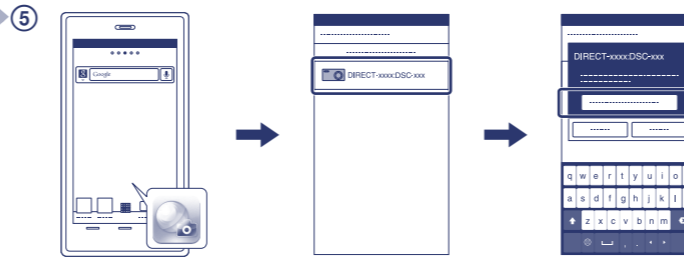

### iOS

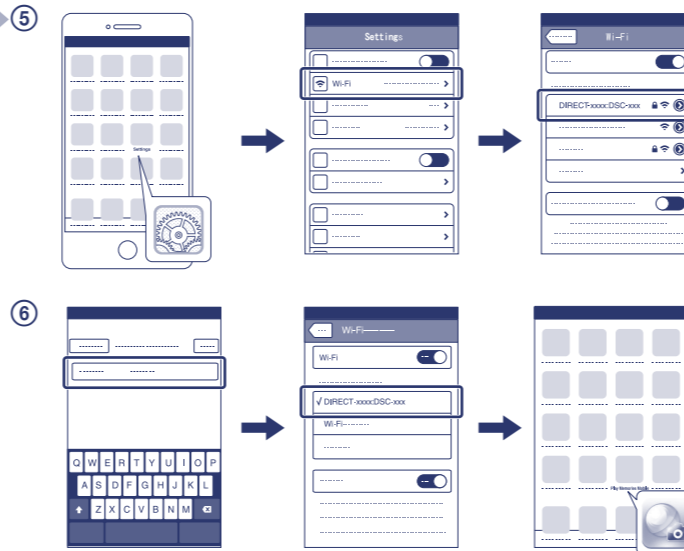

## Android supporting NFC (One-touch sharing) / Android koji podržava NFC (deljenje jednim dodirrom)

**GB** Select an image on the camera to be sent, enable the NFC function on the smartphone, then touch **N** (N mark) of the camera to the smartphone.

**SRB** Izaberite fotografiju na fotoaparatu koju želite da pošaljete, omogućite NFC funkciju na pametnom telefonu, a zatim dodirnite pametnim telefonom **N** (oznaku N) na fotoaparatu.

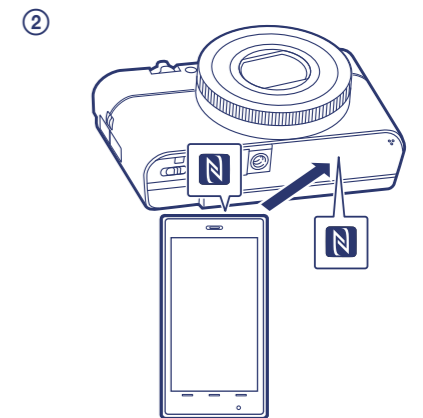
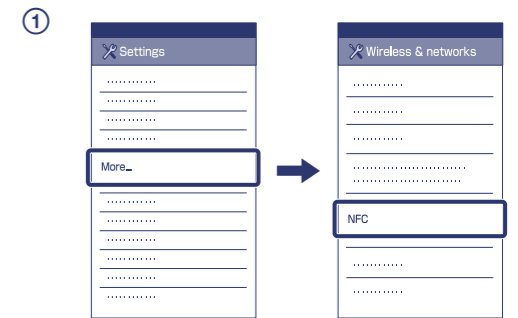

# B-3



**GB** The smartphone can be used as a wireless remote controller for the camera.

**SRB** Pametni telefon se može koristiti kao bežični daljinski upravljač za fotoaparat.

(More info...)

(Više informacija...)

<http://support.d-imaging.sony.co.jp/wi-fi/dsc/2013-2/>